

GENERAL CATALOG - VOL. 1

TURNING GROOVING

we improve, we evolve, we **ADD**

2023/2024





Tungaloy's Insights – Smart Manufacturing

Tungaloy, as one of the leaders in the metal removal industry, offers the latest innovations in grades and geometries for superb performance and tool life.

*Tungaloy's latest
innovations in cutting
tools contribute to
carbon neutrality*



VOL. 1

TURNING GROOVING

A	Grade	A001 -
B	Insert	B001 -
C	External Toolholder	C001 -
D	Internal Toolholder	D001 -
E	Threading Tool	E001 -
F	Parting, Grooving	F001 -
G	Miniature Machining	G001 -
H	Milling Cutter	H001 -
I	Endmill	I001 -
J	Drilling Tool	J001 -
K	Tooling System	K001 -
L	User's Guide	L001 -
M	Alphanumeric Index	M001 -

About Tungaloy Cutting Tool Catalog

■ Note in using this catalog:

- ★ This catalog provides the information of Tungaloy's cutting tools as of September 2022.
- ★ The specifications are subject to change without prior notice for product improvements. Also, the products may be discontinued in the future due to the development of new products.
- ★ The dimensions of all products are shown in millimeters (mm).
- ★ For indexable tools, such as toolholders, cutters, drill bodies, applicable inserts or heads need to be ordered separately.

■ How to use this catalog:

The image shows three pages from the Tungaloy Cutting Tool Catalog illustrating how to use it:

- Page 1 (Product Group Index):** Shows a list of tool categories. Step 1: Select the tool category (e.g., Insert B001-).
- Page 2 (Application Index - TURNING):** Shows technical diagrams and tables for double-clamp toolholders. Step 2: Select the tool type at the application index.
- Page 3 (Application Index - TUNSCAP):** Shows technical diagrams and tables for level-rock toolholders. Step 3: The index is in the alphanumeric order. Use it for your product search.

- 1 Select the tool category at the product group index.
- 2 Select the tool type at the application index on the left pages.
- 3 The index is in the alphanumeric order. Use it for your product search.

■ How to read the list for the standard items:

- ★ Designations for indexable tools – toolholders, adapters, etc.
 - Orders are to be received for the tools with the designations in the catalog.
 - For the tool with right- and left-hand options, the designation includes ****R/L**** as shown below.
 - Ex. 1: Designation: A16Q-STFPR/L13-D180
You can order both right- and left-hand tools. A16Q-STFPR13-D180 (a right-hand tool) and A16Q-STFPL13-D180 (a left-hand tool) will be available.
 - Ex. 2: Designation: A20R-STFPR13-D220
You can order only right-hand tools. Please contact us when you need left-hand tools.
- ★ Lineup for inserts and solid tools
 - Blank : Please contact us regarding the product.

About Tungaloy Cutting Tool Catalog

■ Icons at the left side of each page

External toolholder (cutting edge shape / angle)

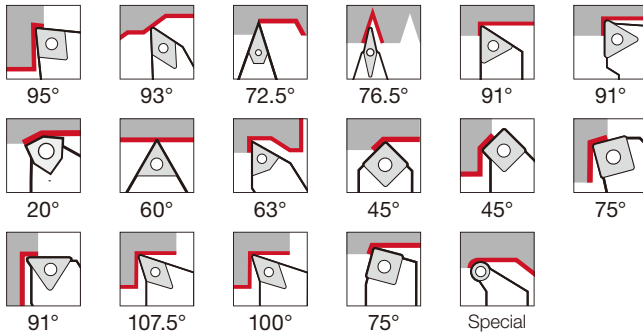

Internal toolholder (cutting edge shape / angle)

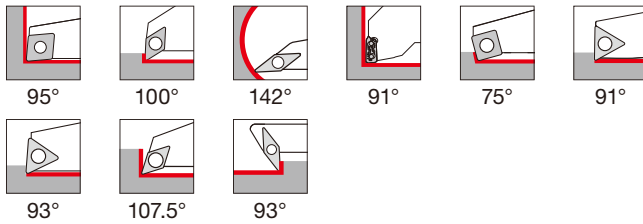

Parting, Grooving

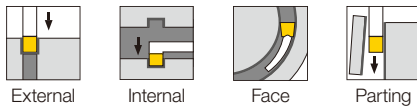

Miniature machining



Mill

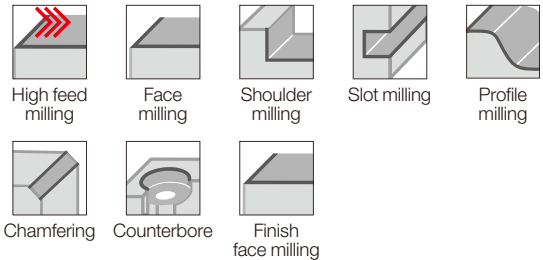

Endmill

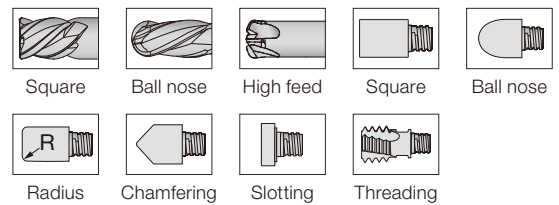

Drill



■ Icons for applications of each product

Threading

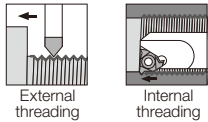

Grooving

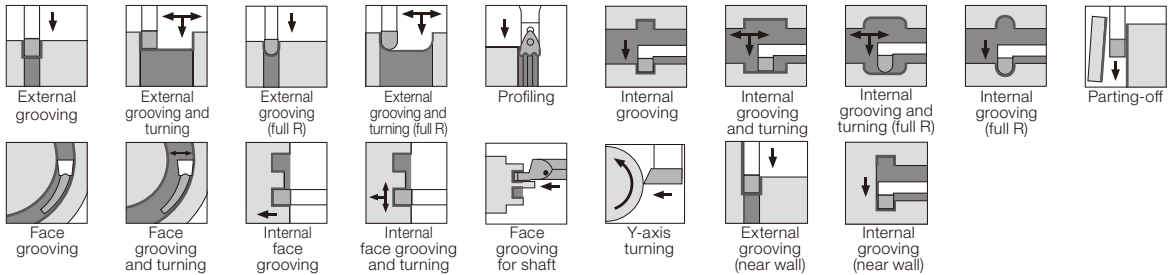

Milling

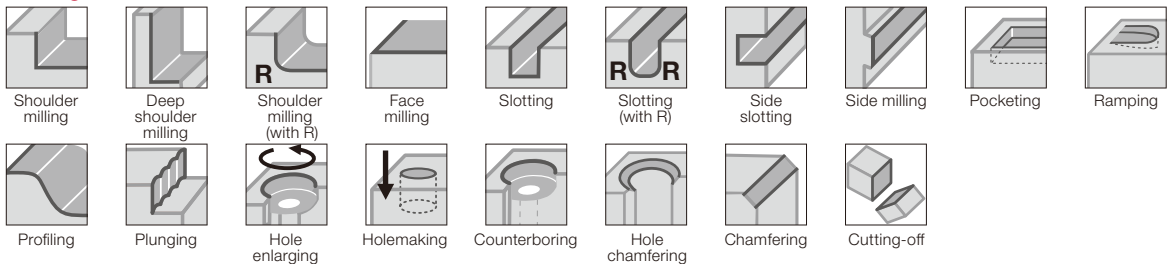

Drilling



About the dimension symbols conforming to ISO13399

■ What is ISO13399?

ISO13399 is an international standard for the purpose of standardizing the electronic data of tools in the world.

■ Switching to the dimension symbols conforming to ISO13399

In this catalog, we use the dimension symbols (properties) conforming to ISO13399 international standard.

Below are the examples of the change.

■ Examples of the change:

	Before	After
Insert		
Turning		
Milling		
Drilling		

ISO13399 standardizes not only the format of 2D and 3D CAD data but also the tool dimension symbols (properties) and reference position information. This allows the tool information to be read and combined into NC programs and CAM software, regardless of any tool maker's data. In addition to General Catalog (paper catalog), we are also updating the symbols in e-catalog (electronic catalog on our website) to the properties conforming to ISO13399. The e-catalog also provides 2D and 3D CAD data in accordance with ISO13399 standard.

■ Insert

New symbol	Old symbol	Description
AN	-	Main cutting edge relief angle
APMX	Max. ap	Maximum depth of cut
AS	A	Side cutting edge relief angle
BW	B	Body width
BS	bs	Side cutting edge (wiper) length
CDX	T max	Maximum groove depth
CW	W	Grooving edge width
D1	ød1	Mounting hole diameter
DCONMS	øDs	Mounting part diameter on the machine
DMIN	øDm	Minimum machining diameter
EPSR	-	Nose angle
GAN	-	Rake angle (insert)
IC	ød	Inscribed circle diameter
INSD	A	Insert diameter (round type)
INSL	B	Insert length
KAPR	κ	Approach angle
LBB	-	Chipbreaker width
LE	A	Effective cutting edge length
LF	L1	Standard length
M	m	Distance from inscribed circle to cutting edge (m dimension)
PDX	t	Thread position (X direction)
PDY	ℓ3	Thread position (Y direction)
PNA	θ	Cutting edge angle
PSIRL	θ	Left-hand front cutting edge angle
PSIRR	θ	Right-hand front cutting edge angle
RE	r	Corner radius
S	T	Thickness
W1	-	Insert width

■ Turning, Grooving

New symbol	Old symbol	Description
B	b	Shank width
BD	øD1, øD2, øD3	Body external diameter
CDX	ar	Maximum groove depth
CND	-	Oil hole diameter
CNT	-	Oil hole plug size
CUTDIA	øDmax	Maximum parting diameter
CW	W	Grooving edge width
CWN	-	Minimum grooving edge width
CWX	-	Maximum grooving edge width
DAXN	øDm	Minimum diameter in face grooving
DAXX	øDmax	Maximum diameter in face grooving
DCONMS	øDs	Mounting part diameter on the machine
DCONWS	øD, ød2	Mounting part diameter on the workpiece
DMIN	øDm	Minimum machining diameter
GAMF	α	Radial rake angle
GAMP	θ	Axial rake angle
H	h	Shank length
HBH	h2	Height of offset on the bottom of head
HBKL	f2	Length of uneven level on the back of head
HBKW	L2	Width of uneven level on the back of head
HBL	L2	Length of offset on the bottom of head
HF	h1	Standard height
KAPR	κ	Approach angle
LB	L	Body length
LF	L1	Standard length
LH	L2	Head length
OAH	h4	Overall height
OAL	L1	Overall length
OAW	L3	Overall width
PSIR	β	Lead angle
WB	-	Body width
WF	f	Standard width
WFS	f2	Standard width (the second corner)

About the dimension symbols conforming to ISO13399

■ Tooling system

New symbol	Old symbol	Description
APMX	Max. ap	Maximum depth of cut
BD	$\varnothing D1, \varnothing D2, \varnothing D3$	Body external diameter
BHTA	α	Neck taper angle (half of nose angle)
BTED	$\varnothing d1$	Taper tip diameter
CRKS	S	Mounting screw size
DBC	$\varnothing d3$	Bolt hole pitch diameter
DCONMS	$\varnothing Ds$	Mounting part diameter on the machine
DCONWS	$\varnothing D, \varnothing d2$	Mounting part diameter on the workpiece
DMIN	$\varnothing Dm$	Minimum machining diameter
GAMF	$\alpha, R.R.$	Radial rake angle
GAMP	$\theta, A.R.$	Axial rake angle
KAPR	κ	Cutting edge angle
LB	L2, L3	Body length
LF	L	Standard length
LPR	L1	Parting length
LS	ℓs	Shank length
LSC	Lmin	Clamp length
LSCX	Lmax	Maximum clamp length
OAH	H4	Overall height
OAL	L	Overall length
OAW	W	Overall width
THID	-	Mounting screw size
WB	W	Body width
WF	f	Standard width

■ Drilling

New symbol	Old symbol	Description
BD	$\varnothing D1, \varnothing D2, \varnothing D3$	Body external diameter
CND	-	Oil hole diameter
CNT	-	Oil hole plug size
CRKS	S	Mounting screw size
DC	$\varnothing Dc$	Machining diameter
DCONMS	$\varnothing Ds$	Mounting part diameter on the machine
DCONWS	$\varnothing D, \varnothing d2$	Mounting part diameter on the workpiece
DCSFMS	$\varnothing D$	Connecting part diameter
KAPR	κ	Cutting edge angle
LCF	ℓ	Flute length
LF	Lf	Standard length (from the drill shoulder)
LPR	-	Parting length (from flange to tip)
LS	ℓs	Shank length
LU	ℓ	Machinable depth
NOF	z	Number of flutes
OAL	L	Overall length (from tip)
PL	PL	Distance from drill tip to shoulder
ZEFP	Z eff	Number of effective cutting edges on periphery

■ Milling

New symbol	Old symbol	Description
APMX	Max. ap	Maximum depth of cut
BD	$\varnothing D1, \varnothing D2, \varnothing D3$	Body external diameter
BHTA	α	Neck taper angle (half of nose angle)
CBDP	ℓ	Mounting hole depth
CDX	Max. ae	Maximum slot width
CHW	k	Chamfer width on the corner
CICT	z	Number of inserts
CRKS	S	Mounting screw size
CW	W	Slotting edge width
CWN	-	Minimum slotting edge width
CWX	-	Maximum slotting edge width
DBC	$\varnothing d3$	Bolt hole pitch diameter
DC	$\varnothing Dc$	Machining diameter
DCONMS	$\varnothing d$	Mounting part diameter on the machine
DCONWS	$\varnothing D, \varnothing d2$	Mounting part diameter on the workpiece
DCSFMS	$\varnothing Db$	Mounting surface diameter on the machine
DCX	$\varnothing Dc1$	Maximum machining diameter
GAMF	R.R.	Radial rake angle
GAMP	A.R.	Axial rake angle
H	T	Width across flat
KAPR	κ	Cutting edge angle
KWW	a	Drive key width
LF	Lf	Standard length
LH	Lf	Neck length
LS	ℓs	Shank length
NOF	z	Number of flutes
OAL	L, L6	Overall length
PDX	t	Thread position (X direction)
PNA	θ	Cutting edge angle
PSIR	β	Lead angle
RMPX	θ	Maximum ramping angle
THUB	T	Hub height (slot mill)
WT	Kg	Weight
ZEFP	Z eff	Number of effective cutting edges on the periphery

Note:

- Symbols unspecified in ISO13399 standard and Tungaloy's original symbols are not included.
- The symbols still under discussion are included. Please note any change or addition may occur.

■ CAD data provided in e-catalog

● 2D data (DXF format file)

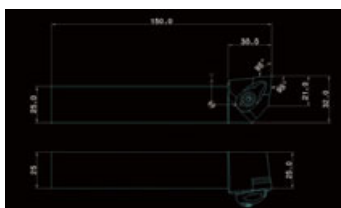

Turning:
Shows the insert with standard corner radius.

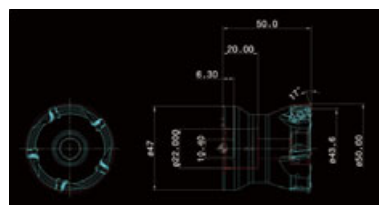

Milling:
Includes actual cutting edge curve (CUT layer) and body cross section (NOCUT layer).

● 3D data Light type (STP format file): Can be used to check tool path and interference.

Turning: Equipped with an insert with a standard corner radius.

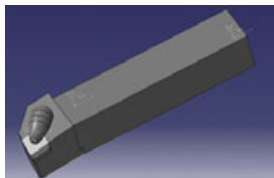

Milling: A rotating body model of an actual cutting edge curve and a body cross section.



● 3D data Detail type (STP format file): Can be used to create a new tool layout chart. (Can be combined with any insert model on a CAD software.)

Turning

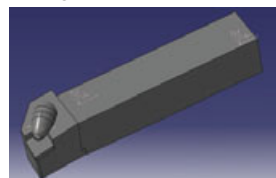

Milling



Insert



Insert - Content structure

- Inserts are grouped in Positive type, Negative type, and CBN/PCD.
- The list is in alphabetical order.
- The order of the list: C (80°) → D (55°) → R (360°) → S (90°) → T (60°) → V (35°) → W (80°) → Y (25°) → Other shapes
- The order of inserts:
 - Negative type (each shape with hole → without hole)
 - Positive type (each shape with hole → without hole)
- The order of chipbreakers:
 - From precision finishing to heavy cutting, in the order of the values of cutting depth and feed rate.
- Insert without chipbreaker is on the last page of each shape.
- Introduces the proposed inserts according to the workpiece materials and the shape of workpiece materials.
- The standard cutting conditions for typical chipbreakers are at the bottom of the pages.
- ● in the catalog describes our standard items, and ▲ means the item to be discontinued in the future.

How to use the page

Method ①

Select an insert at the right end, and choose the information page by the insert type (1) and the outer shape of the insert (2) at the left end.

Method ②

Check the page of each insert type from the index on B003 (1), and choose the page of the setting information according to the outer shape of the insert (2).

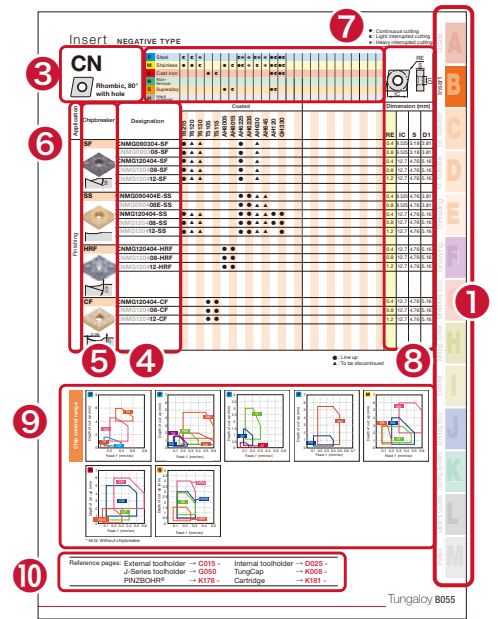
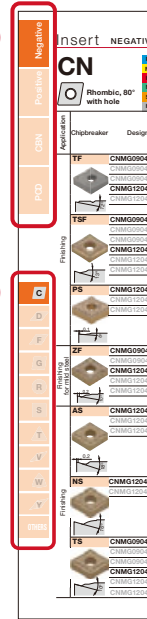
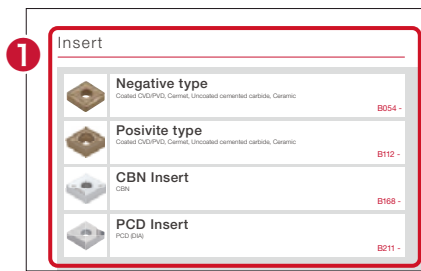

Method ③

Select an insert at the chipbreaker introduction and the selection guide on B004 - B029 and check the details on the product page.

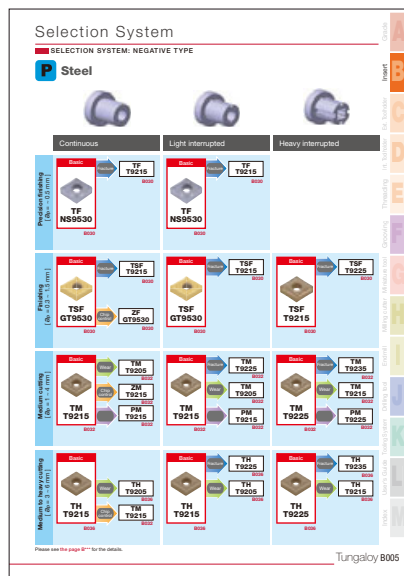
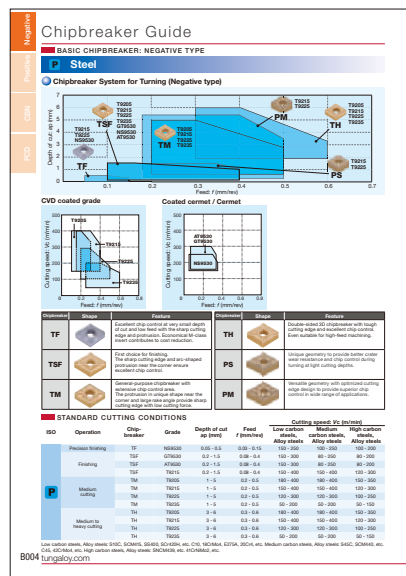

Method ④

Select an insert from the list of chipbreaker shapes on B030-B053 and check the details on each page.

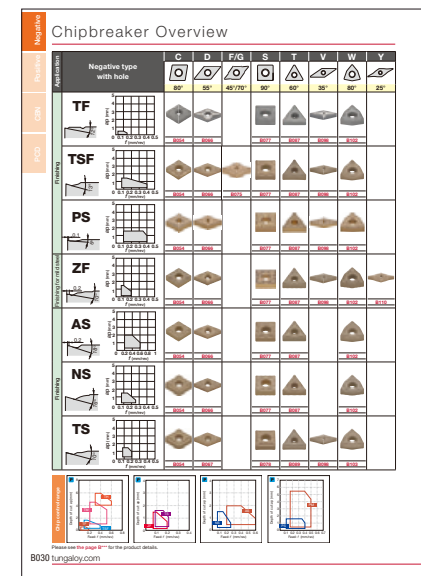

When ordering

- Please specify the designation, grade, and quantity.
e.g. **CNMG120408-TM T9215 ... 10 pieces** (10 inserts per package)
- *You will find a note if the number per package is not 10.

Insert

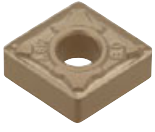

Negative type

Coated CVD/PVD, Cermet, Uncoated cemented carbide, Ceramic

B054 -



Positive type

Coated CVD/PVD, Cermet, Uncoated cemented carbide, Ceramic

B112 -



CBN Insert

CBN

B168 -



PCD Insert

PCD (DIA)

B211 -

Chipbreaker Guide

BASIC CHIPBREAKER: NEGATIVE TYPE

P Steel

Chipbreaker System for Turning (Negative type)

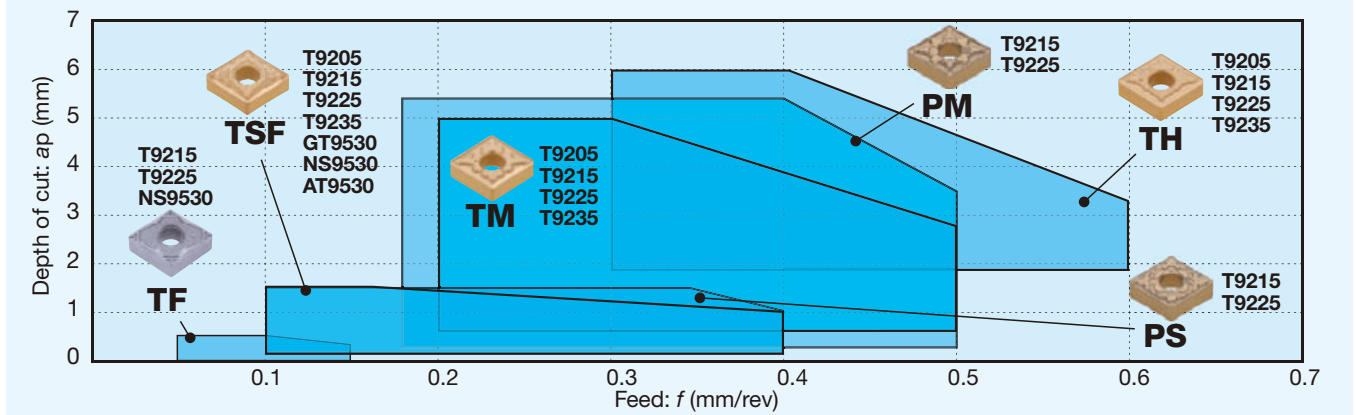

CVD coated grade

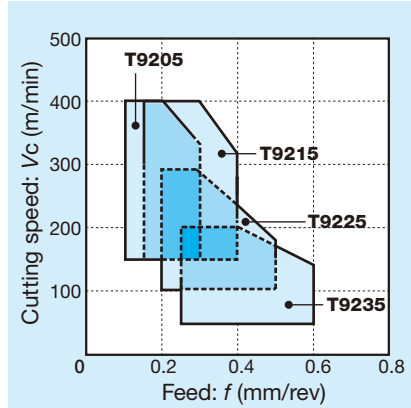

Coated cermet / Cermet

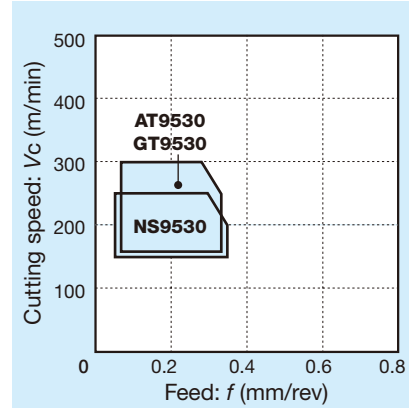

Chipbreaker	Shape	Feature	Chipbreaker	Shape	Feature
TF		Excellent chip control at very small depth of cut and low feed with the sharp cutting edge and protrusion. Economical M-class insert contributes to cost reduction.	TH		Double-sided 3D chipbreaker with tough cutting edge and excellent chip control. Even suitable for high-feed machining.
TSF		First choice for finishing. The sharp cutting edge and arc-shaped protrusion near the corner ensure excellent chip control.	PS		Unique geometry to provide better crater wear resistance and chip control during turning at light cutting depths.
TM		General-purpose chipbreaker with extensive chip control area. The protrusion in unique shape near the corner and large rake angle provide sharp cutting edge with low cutting force.	PM		Versatile geometry with optimized cutting edge design to provide superior chip control in wide range of applications.

STANDARD CUTTING CONDITIONS

ISO	Operation	Chip-breaker	Grade	Depth of cut ap (mm)	Feed f (mm/rev)	Cutting speed: Vc (m/min)		
						Low carbon steels, Alloy steels	Medium carbon steels, Alloy steels	High carbon steels, Alloy steels
P	Precision finishing	TF	NS9530	0.05 - 0.5	0.03 - 0.15	150 - 250	100 - 250	100 - 200
		TSF	GT9530	0.2 - 1.5	0.08 - 0.4	150 - 300	80 - 250	80 - 200
	Finishing	TSF	AT9530	0.2 - 1.5	0.08 - 0.4	150 - 300	80 - 250	80 - 200
		TSF	T9215	0.2 - 1.5	0.08 - 0.4	150 - 400	150 - 400	120 - 300
	Medium cutting	TM	T9205	1 - 5	0.2 - 0.5	180 - 400	180 - 400	150 - 350
		TM	T9215	1 - 5	0.2 - 0.5	150 - 400	150 - 400	120 - 300
		TM	T9225	1 - 5	0.2 - 0.5	120 - 300	120 - 300	100 - 250
		TM	T9235	1 - 5	0.2 - 0.5	50 - 200	50 - 200	50 - 150
	Medium to heavy cutting	TH	T9205	3 - 6	0.3 - 0.6	180 - 400	180 - 400	150 - 350
		TH	T9215	3 - 6	0.3 - 0.6	150 - 400	150 - 400	120 - 300
TH		T9225	3 - 6	0.3 - 0.6	120 - 300	120 - 300	100 - 250	
TH		T9235	3 - 6	0.3 - 0.6	50 - 200	50 - 200	50 - 150	

Low carbon steels, Alloy steels: S10C, SCM415, SS400, SCr420H, etc. C10, 18CrMo4, E275A, 20Cr4, etc. Medium carbon steels, Alloy steels: S45C, SCM440, etc. C45, 42CrMo4, etc. High carbon steels, Alloy steels: SNCM439, etc. 41CrNiMo2, etc.

Selection System

SELECTION SYSTEM: NEGATIVE TYPE

P Steel

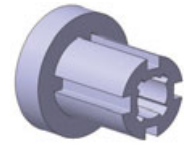
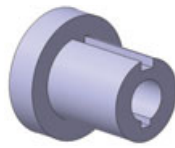
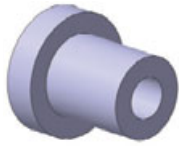

Continuous

Light interrupted

Heavy interrupted

	Continuous	Light interrupted	Heavy interrupted
Precision finishing [$a_p = \sim 0.5 \text{ mm}$]	<p>Basic</p> <p>Fracture</p> <p>TF NS9530 B030</p> <p>TF T9215 B030</p>	<p>Basic</p> <p>Fracture</p> <p>TF NS9530 B030</p> <p>TF T9215 B030</p>	
Finishing [$a_p = 0.3 \sim 1.5 \text{ mm}$]	<p>Basic</p> <p>Fracture</p> <p>TSF GT9530 B030</p> <p>Chip control</p> <p>ZF GT9530 B030</p> <p>TSF T9215 B030</p>	<p>Basic</p> <p>Fracture</p> <p>TSF GT9530 B030</p> <p>TSF T9215 B030</p>	<p>Basic</p> <p>Fracture</p> <p>TSF T9225 B030</p>
Medium cutting [$a_p = 1 \sim 4 \text{ mm}$]	<p>Basic</p> <p>Wear</p> <p>Chip control</p> <p>Crater wear</p> <p>TM T9215 B032</p> <p>TM T9205 B032</p> <p>ZM T9215 B032</p> <p>PM T9215 B032</p>	<p>Basic</p> <p>Fracture</p> <p>Wear</p> <p>Crater wear</p> <p>TM T9215 B032</p> <p>TM T9225 B032</p> <p>TM T9205 B032</p> <p>PM T9215 B032</p>	<p>Basic</p> <p>Fracture</p> <p>Wear</p> <p>Crater wear</p> <p>TM T9225 B032</p> <p>TM T9235 B032</p> <p>TM T9215 B032</p> <p>PM T9225 B032</p>
Medium to heavy cutting [$a_p = 3 \sim 6 \text{ mm}$]	<p>Basic</p> <p>Wear</p> <p>Chip control</p> <p>TH T9215 B036</p> <p>TH T9205 B036</p> <p>TM T9215 B032</p>	<p>Basic</p> <p>Fracture</p> <p>Wear</p> <p>TH T9215 B036</p> <p>TH T9225 B036</p> <p>TH T9205 B036</p>	<p>Basic</p> <p>Fracture</p> <p>Wear</p> <p>TH T9225 B036</p> <p>TH T9235 B036</p> <p>TH T9215 B036</p>

Please see the page B*** for the details.

Grade
Insert
Ext. Toolholder
Int. Toolholder
Threading
Grooving
Milling cutter
Miniature tool
Endmill
Drilling tool
Tooling System
User's Guide
Index



Chipbreaker Guide

BASIC CHIPBREAKER: NEGATIVE TYPE

M Stainless Steel

Chipbreaker System for Turning (Negative type)

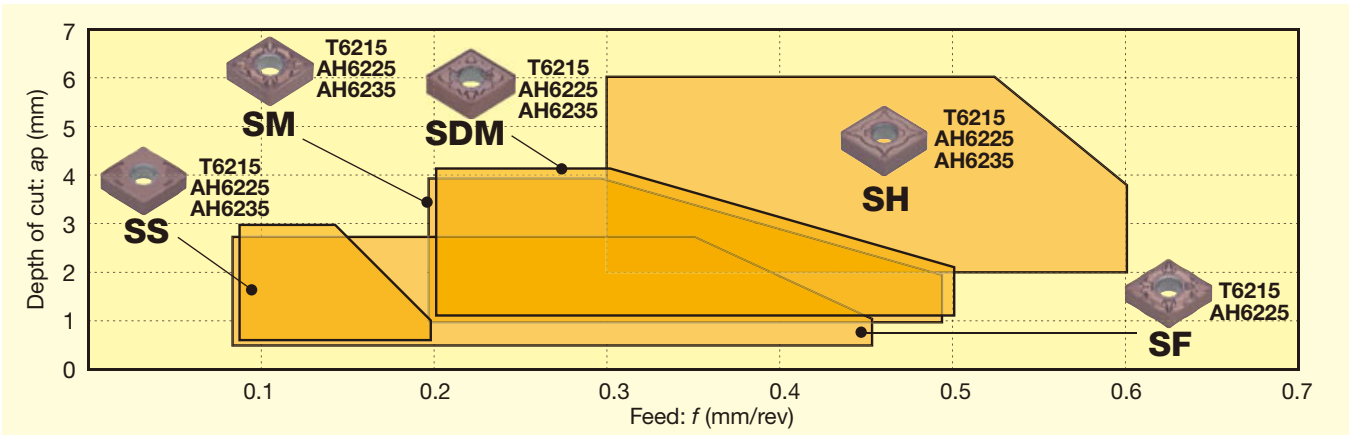

Austenitic stainless steel

Ferritic / martensite stainless steel

Precipitation hardened stainless steel

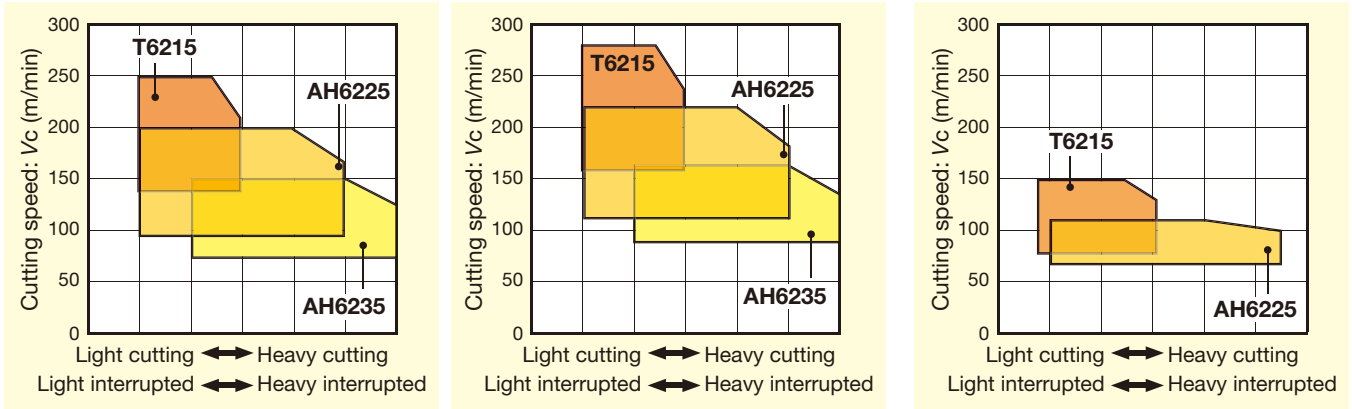

Chipbreaker	Shape	Feature	Chipbreaker	Shape	Feature
SF		Excellent chip control with small depth of cut at high feed. Suitable for finishing stainless steel.	SM		General-purpose chipbreaker with sharpness and good chip control. First choice for stainless steel.
SH		Suitable for medium to heavy cutting. High fracture resistance with specially reinforced cutting edge. Ideal for machining that requires cutting edge strength, such as roughing and interrupted cutting.	SDM		Light cutting geometry for notch wear and crater wear resistance.

STANDARD CUTTING CONDITIONS

ISO	Operation	Chipbreaker	Grade	Depth of cut ap (mm)	Feed f (mm/rev)	Cutting speed: Vc (m/min)		
						Austenitic stainless steel	Ferritic / martensite stainless steel	Precipitation hardened stainless steel
M	Finishing	SF	T6215	0.5 - 2.5	0.08 - 0.45	140 - 240	160 - 280	80 - 150
			AH6225	0.5 - 2.5	0.08 - 0.45	90 - 200	110 - 240	60 - 110
			AH6235	0.5 - 2.5	0.08 - 0.45	50 - 150	70 - 170	-
	Medium cutting	SM	T6215	1 - 4	0.2 - 0.5	140 - 240	160 - 280	80 - 150
			AH6225	1 - 4	0.2 - 0.5	90 - 200	110 - 240	60 - 110
			AH6235	1 - 4	0.2 - 0.5	50 - 150	70 - 170	-
			T6215	1 - 4	0.2 - 0.5	140 - 240	160 - 280	80 - 150
			AH6225	1 - 4	0.2 - 0.5	90 - 200	110 - 240	60 - 110
			AH6235	1 - 4	0.2 - 0.5	50 - 150	70 - 170	-
	Heavy cutting	SH	T6215	2 - 6	0.3 - 0.6	140 - 240	160 - 280	80 - 150
AH6225			2 - 6	0.3 - 0.6	90 - 200	110 - 240	60 - 110	
AH6235			2 - 6	0.3 - 0.6	50 - 150	70 - 170	-	

Stainless steels: SUS304, SUS316, etc. X5CrNi18-9, X5CrNiMo17-12-3, etc.

Selection System

SELECTION SYSTEM: NEGATIVE TYPE

M Stainless Steel

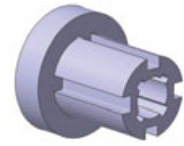
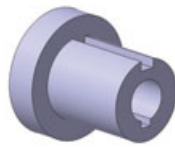
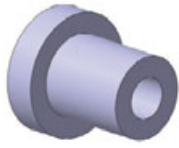

Continuous

Light interrupted

Heavy interrupted



Please see the page B*** for the details.

Grade
Insert
Ext. Toolholder
Int. Toolholder
Threading
Grooving
Milling cutter
Endmill
Drilling tool
Tooling System
User's Guide
Index



Chipbreaker Guide

BASIC CHIPBREAKER: NEGATIVE TYPE

K Cast Iron

Chipbreaker System for Turning (Negative type)

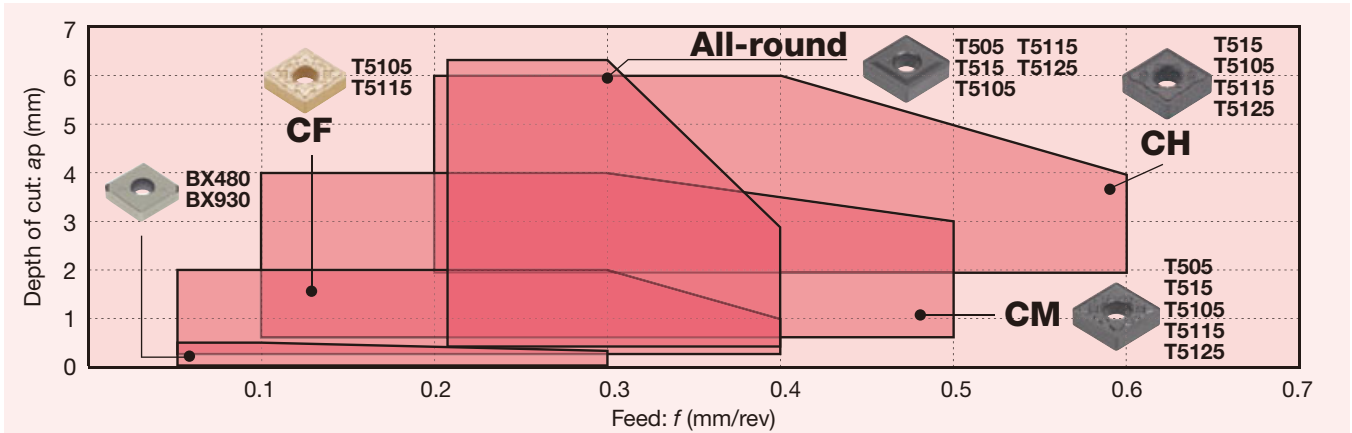

Grey cast iron

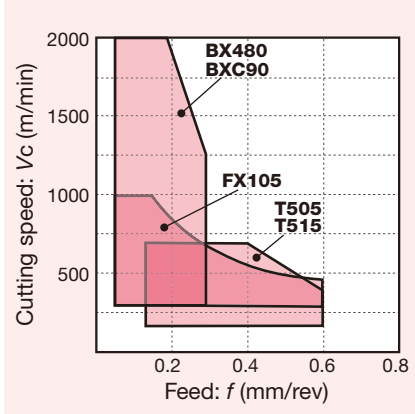

Ductile cast iron

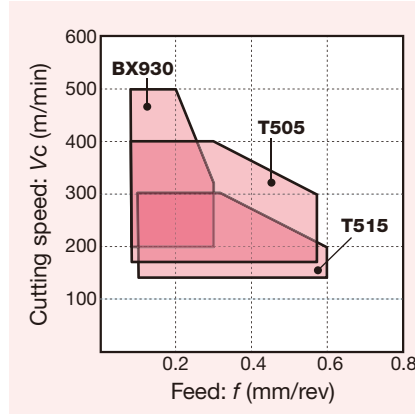

Chipbreaker	Shape	Feature
-		Excellent performance in high-speed finishing of cast iron with CBN sintered body on the cutting edge.
CF		Low cutting force chipbreaker for cast iron. Combined with an arc-shaped high rake angle (substantially 20°) drastically reduces cutting force and prevents the deformation and burr of thin-walled components.
All-round		Excellent performance in interrupted cutting. Highly reliable chipbreaker with great stability.

Chip-breaker	Shape	Feature
CM		First choice for cast iron. Versatile chipbreaker for a wide range of applications from continuous to interrupted cutting thanks to the positive land and wide chip pocket.
CH		Chipbreaker with reinforced cutting edge. The negative land and the land support provide stable insert seating and increase cutting edge strength, resulting in no fracture even in heavy cutting.

STANDARD CUTTING CONDITIONS

ISO	Operation	Chip-breaker	Grade	Depth of cut a_p (mm)	Feed f (mm/rev)	Cutting speed: V_c (m/min)	
						Grey cast iron	Ductile cast iron
K	High speed cutting	-	BX930	0.05 - 0.5	0.05 - 0.2	300 - 1200	200 - 500
		-	BX480	0.05 - 0.5	0.05 - 0.3	300 - 2000	200 - 300
		-	BXC90	0.08 - 3	0.05 - 0.4	300 - 2000	200 - 300
	Finishing	All-round	T505	1 - 5	0.1 - 0.5	180 - 700	180 - 400
		All-round	T515	1 - 5	0.1 - 0.5	150 - 700	150 - 300
	Medium cutting	All-round	T505	1 - 5	0.1 - 0.5	180 - 700	180 - 400
		All-round	T515	1 - 5	0.1 - 0.5	150 - 700	150 - 300
	Medium to heavy cutting	CH	T515	3 - 6	0.2 - 0.6	150 - 700	150 - 300
		All-round	T515	1 - 5	0.1 - 0.5	150 - 700	150 - 300
			CH	T515	3 - 6	0.2 - 0.6	150 - 700

Grey cast iron: FC250, etc. 250, etc. Ductile cast iron: FCD450, etc. 450-10S, etc.

Selection System

SELECTION SYSTEM: NEGATIVE TYPE

K Cast Iron

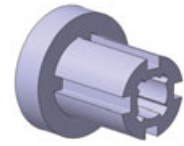
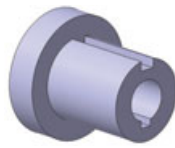

Continuous

Light interrupted

Heavy interrupted

Precision finishing
[$a_p = \sim 0.5 \text{ mm}$]

Basic

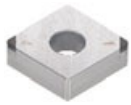

BX480

B168 - B188

Basic

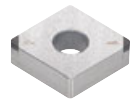

BX480

B168 - B188



**All-round
T515**

B033

Basic



BXC90

B168 - B188

Finishing
[$a_p = 0.5 \sim 2 \text{ mm}$]

Basic

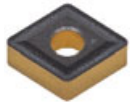

**All-round
T505**

B033



**All-round
T515**

B033



**CF
T5105**

B031

Basic



**All-round
T515**

B033



**All-round
T505**

B033



**CH
T515**

B036



**CF
T5115**

B031

Basic

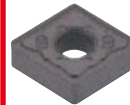

**CH
T515**

B036



**All-round
T505**

B033



**All-round
T515**

B033

Medium cutting
[$a_p = 1 \sim 5 \text{ mm}$]

Basic



**All-round
T505**

B033



**All-round
T515**

B033



**CF
T5105**

B031

Basic



**All-round
T515**

B033



**All-round
T505**

B033



**CH
T515**

B036



**CF
T5115**

B031

Basic

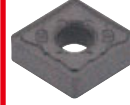

**CH
T515**

B036



**All-round
T505**

B033



**CH
T5125**

B036



**All-round
T515**

B033

Medium to heavy cutting
[$a_p = 3 \sim 6 \text{ mm}$]

Basic



**All-round
T515**

B033



**All-round
T505**

B033



**CF
T5105**

B031

Basic



**All-round
T515**

B033



**All-round
T505**

B033



**CH
T515**

B036



**CF
T5115**

B031

Basic

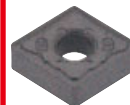

**CH
T515**

B036



**All-round
T505**

B033



**CH
T5125**

B036



**All-round
T515**

B033

Please see the page B*** for the details.

Chipbreaker Guide

BASIC CHIPBREAKER: NEGATIVE TYPE

N Non-ferrous Metal

Chipbreaker System for Turning (Negative type)

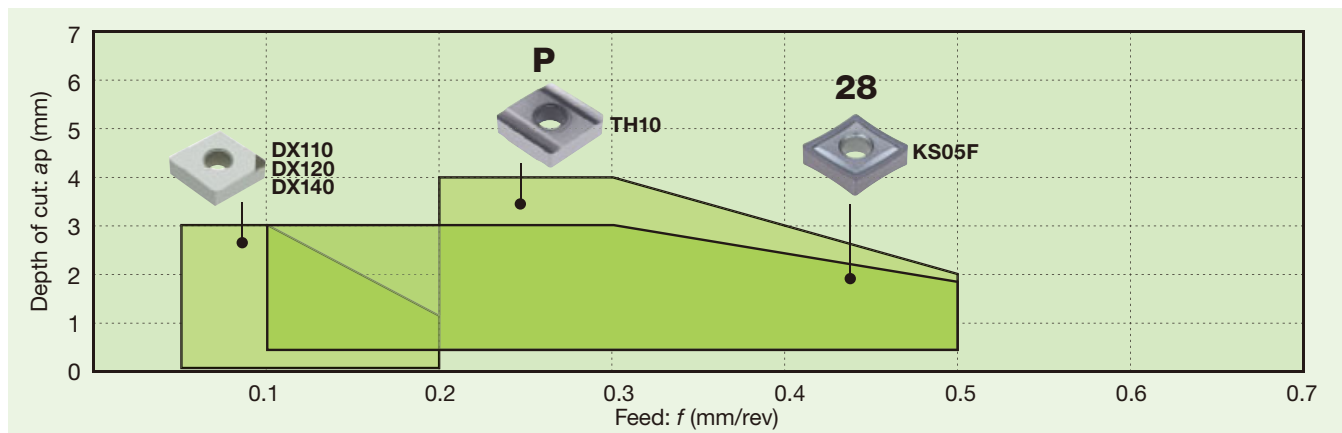

Aluminium alloy (Si < 12%)

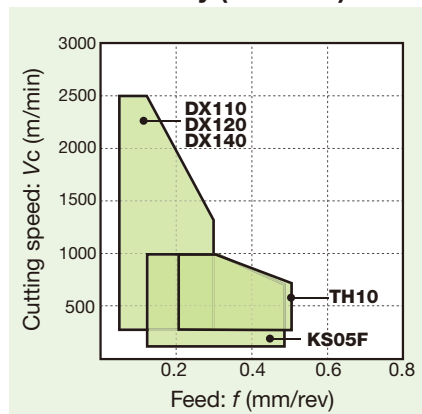

Aluminium alloy (Si ≥ 12%)

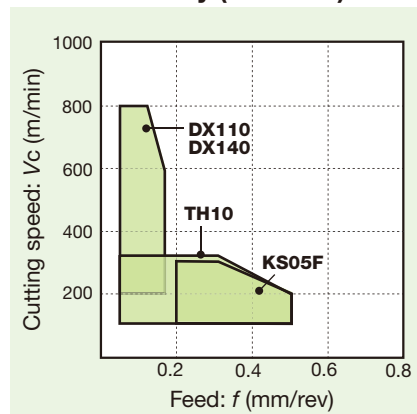

Copper alloy

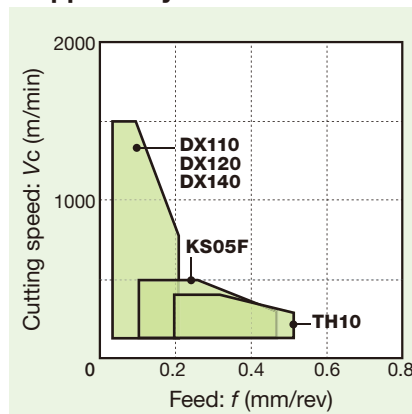

Chipbreaker	Shape	Feature
-		Excellent performance in high-speed finishing of non-ferrous metal, such as aluminium and copper alloy, with diamond sintered body on the cutting edge.
P		Excellent sharpness for non-ferrous metal, such as aluminium and copper alloy.

Chipbreaker	Shape	Feature
With chip-breaker		Wide chipbreaker for excellent chip control.
28		Low cutting geometry with large inclination for finishing to medium cutting range.

STANDARD CUTTING CONDITIONS

ISO	Operation	Chip-breaker	Grade	Depth of cut ap (mm)	Feed f (mm/rev)	Cutting speed: Vc (m/min)		
						Aluminium alloy (Si < 12%)	Aluminium alloy (Si ≥ 12%)	Copper alloy
N	Precision finishing	With	DX110	0.05 - 0.5	0.05 - 0.15	500 - 2500	400 - 800	500 - 1500
		-	DX140	0.05 - 0.5	0.05 - 0.20	300 - 2500	400 - 800	500 - 1500
	Finishing	With	DX110	0.05 - 2	0.05 - 0.15	500 - 2500	400 - 800	500 - 1500
		-	DX140	0.05 - 2	0.05 - 0.15	300 - 1800	400 - 600	400 - 1200
	Medium cutting	P	TH10	0.5 - 4	0.2 - 0.5	100 - 1000	100 - 300	100 - 300
		P	KS05F	0.5 - 3	0.1 - 0.5	100 - 1200	100 - 300	100 - 300
		P	KS05F	0.5 - 3	0.1 - 0.5	100 - 1200	100 - 300	100 - 300
		P	TH10	0.5 - 4	0.2 - 0.5	100 - 1000	100 - 300	100 - 300

Selection System

SELECTION SYSTEM: NEGATIVE TYPE



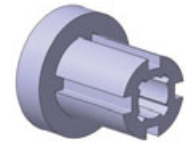
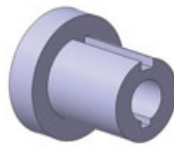
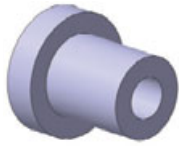

N Non-ferrous Metal

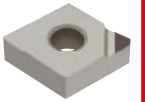

Continuous

Light interrupted

Heavy interrupted

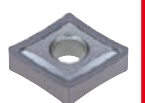
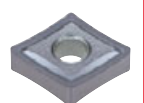
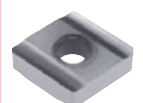
	Continuous	Light interrupted	Heavy interrupted
Precision finishing [$a_p = \sim 0.5 \text{ mm}$]	Basic  With chipbreaker DX110 B211 - B212 → Wear → DX140 B211 - B212	Basic  DX140 B211 - B212 → Surface quality → With chipbreaker DX110 B211 - B212 → Wear → DX160 B211 - B212	
Finishing [$a_p = 0.5 \sim 2 \text{ mm}$]	Basic  DX140 B211 - B212 → Surface quality → With chipbreaker DX110 B211 - B212 → Wear → DX160 B211 - B212	Basic  DX140 B211 - B212 → Fracture → P TH10 B035 → Wear → DX160 B211 - B212	Basic  P TH10 B035
Medium cutting [$a_p = 1 \sim 4 \text{ mm}$]	Basic  28 KS05F B035 → Wear → DX140 B211 - B212	Basic  28 KS05F B035 → Wear → DX140 B211 - B212	Basic  P TH10 B035

Please see the page B*** for the details.

Grade
Insert
Ext. Toolholder
Int. Toolholder
Threading
Grooving
Milling cutter
Miniature tool
Endmill
Drilling tool
Tooling System
User's Guide
Index

A
B
C
D
E
F
G
H
I
J
K
L
M

Chipbreaker Guide

BASIC CHIPBREAKER: NEGATIVE TYPE

S Heat resistant superalloys

Chipbreaker System for Turning (Negative type)

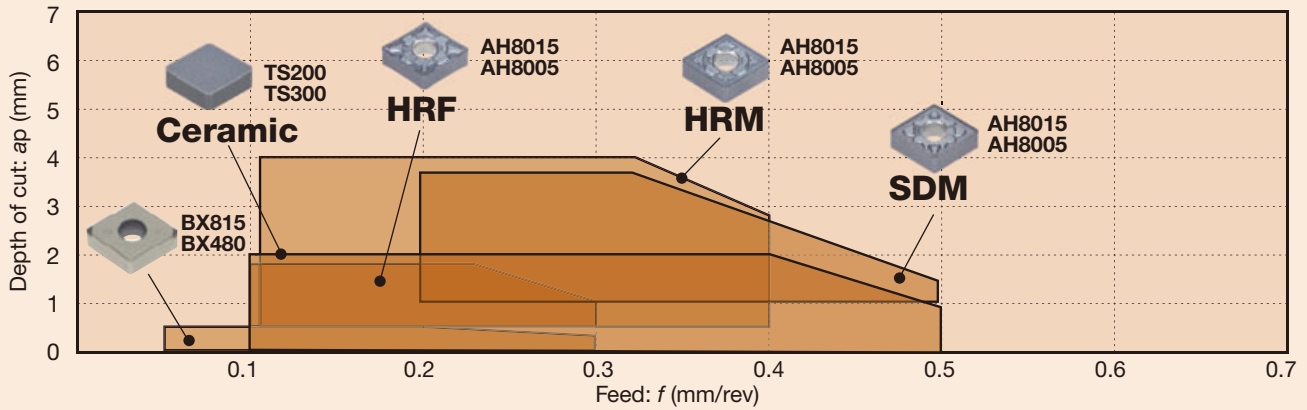

Titanium alloy

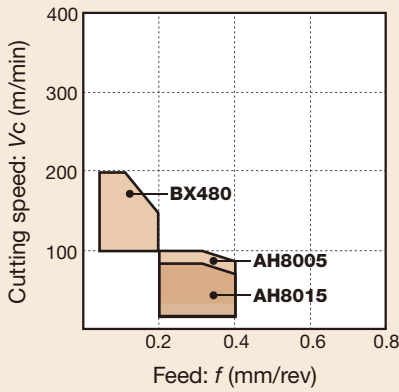

Ni-base alloy

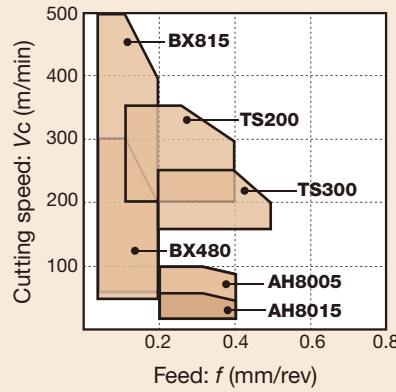

Chipbreaker	Shape	Feature
HRF		Suitable for finishing superalloy. Unique protrusion improves chip control in cutting low depth.
HRM		First choice for heat-resistant alloy. The geometry optimized for a wide range of depths of cut.
SDM		Light cutting geometry for notch wear and crater wear resistance.

Chipbreaker	Shape	Feature
-		Excellent performance in finishing of heat-resistant alloy and titanium alloy with CBN sintered body on the cutting edge.
Ceramic		Suitable for roughing operation of heat-resistant alloy, due to the SiAlON ceramic with high-temperature strength.

STANDARD CUTTING CONDITIONS

ISO	Operation	Chip-breaker	Grade	Depth of cut ap (mm)	Feed f (mm/rev)	Cutting speed: Vc (m/min)	
						Titanium alloy	Ni-base alloy
S	Precision finishing	-	BX480	0.1 - 0.5	0.05 - 0.2	100 - 200	70 - 300
		-	BX815	0.1 - 0.5	0.05 - 0.2	-	70 - 500
	Finishing to medium cutting	-	TS200	0.1 - 2	0.1 - 0.4	-	200 - 350
		-	TS300	0.1 - 2	0.2 - 0.5	-	150 - 250
		HRF	AH8005	0.5 - 1.5	0.05 - 0.25	20 - 100	20 - 100
		HRF	AH8015	0.5 - 1.5	0.05 - 0.25	20 - 80	20 - 50
		HRF	AH8015	0.5 - 1.5	0.05 - 0.25	10 - 60	10 - 40
	Medium cutting	HRM	AH8005	0.5 - 4	0.1 - 0.4	20 - 100	20 - 100
		HRM	AH8015	0.5 - 4	0.1 - 0.4	20 - 80	20 - 50
HRM		AH8015	0.5 - 4	0.1 - 0.4	10 - 60	10 - 40	

Ni-base alloy: INCONEL718, etc. Titanium alloy: Ti-6Al-4V, etc.

Selection System

SELECTION SYSTEM: NEGATIVE TYPE

S Heat resistant superalloys

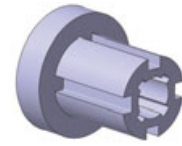
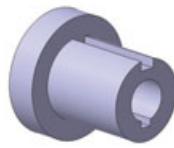
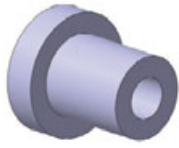

Continuous

Light interrupted

Heavy interrupted

	Continuous	Light interrupted	Heavy interrupted
Precision finishing [$a_p = \sim 0.5 \text{ mm}$]	<p>Basic</p> <p>Fracture → HRF AH8005 B038</p> <p>BX815 B168 - B188</p>	<p>Basic</p> <p>Fracture → HRF AH8005 B038</p> <p>BX480 B168 - B188</p>	
Finishing [$a_p = 0.5 \sim 1.5 \text{ mm}$]	<p>Basic</p> <p>Fracture → HRF AH8015 B031</p> <p>Chip control → 28 AH8005 B035</p> <p>High-speed wear → TS300 B038, B039</p> <p>Crater wear → SDM AH8005 B033</p> <p>HRF AH8005 B031</p>	<p>Basic</p> <p>Fracture → HRM AH8015 B035</p> <p>Wear → HRF AH8005 B031</p> <p>Chip control → 28 AH8015 B035</p> <p>Crater wear → SDM AH8015 B033</p> <p>HRF AH8015 B031</p>	<p>Basic</p> <p>Fracture → HRM AH8015 B034</p> <p>Wear → HRF AH8005 B031</p> <p>Crater wear → SDM AH8015 B033</p> <p>HRF AH8015 B031</p>
Medium cutting [$a_p = 0.5 \sim 4 \text{ mm}$]	<p>Basic</p> <p>Fracture → HRM AH8015 B034</p> <p>Burr occurrence → HRF AH8015 B031</p> <p>Chip control → 28 AH8005 B035</p> <p>Crater wear → SDM AH8005 B033</p> <p>HRM AH8005 B034</p>	<p>Basic</p> <p>Fracture → SM AH630 B033</p> <p>Wear → HRM AH8005 B034</p> <p>Chip control → 28 AH8015 B035</p> <p>Crater wear → SDM AH8015 B033</p> <p>HRM AH8015 B035</p>	<p>Basic</p> <p>Wear → HRF AH8005 B031</p> <p>Crater wear → SDM AH8015 B033</p> <p>HRM AH8015 B034</p>

Please see the page B*** for the details.

Grade

Insert

Ext. Toolholder

Int. Toolholder

Threading

Grooving

Miniature tool

Milling cutter

Endmill

Drilling tool

Tooling System

User's Guide

Index

Chipbreaker Guide

BASIC CHIPBREAKER: NEGATIVE TYPE

H Hard Materials

Chipbreaker System for Turning (Negative type)

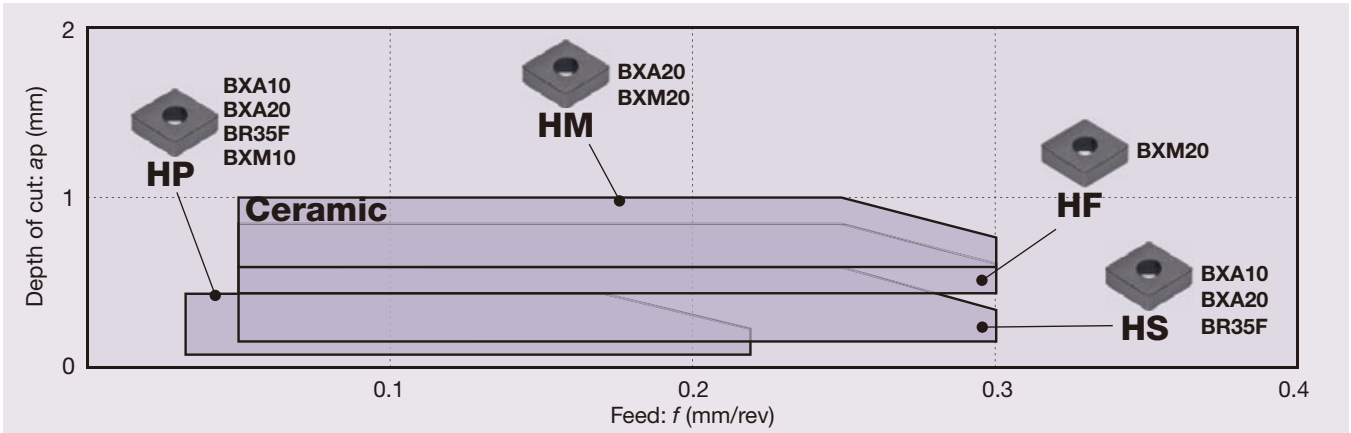

Coated CBN

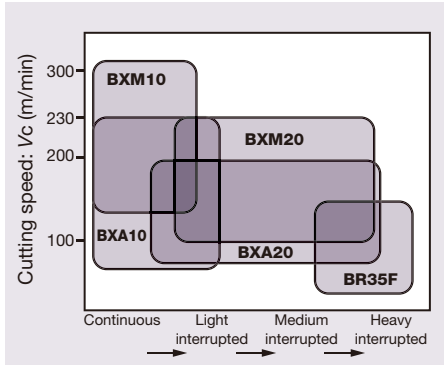

T-CBN

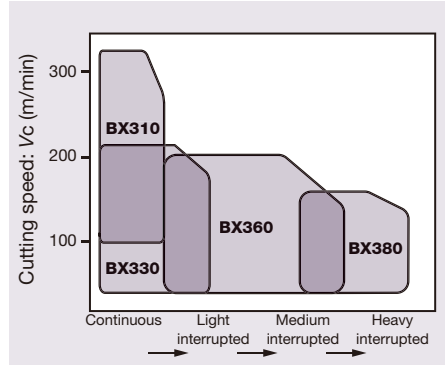

Ceramic, PVD coating

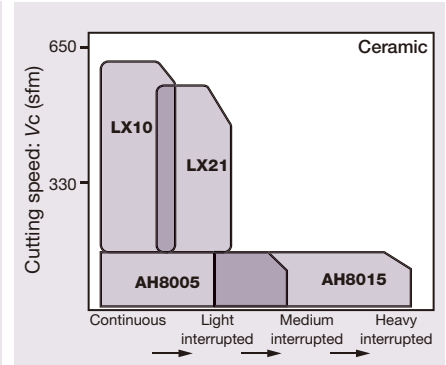

Chipbreaker	Shape	Feature
-		Excellent performance in finishing of hard material with CBN sintered body on the cutting edge.
- (Ceramic)		Realizes economical hardened steel medium speed finishing.
HRF		Excellent chip control in Hardent steel medium finishing.

Chipbreaker	Shape	Feature
HF		Excellent chip control in removing carburized layer at small depth of cut.
HM		Excellent chip control in removing carburized layer at large depth of cut.
HP		Excellent chip control in precision finishing.
HS		Provides the excellent chip-control at a high-feed condition in the precise finishing operation.

STANDARD CUTTING CONDITIONS

ISO	Operation	Chipbreaker	Grade	Depth of cut ap (mm)	Feed f (mm/rev)	Cutting speed Vc (m/min)
H	Precision finishing	HP	BXA10 BXA20 BR35F	0.03 - 0.25	0.03 - 0.22	70 - 350
		HS	BXA10 BXA20 BR35F	0.1 - 0.35	0.05 - 0.3	70 - 350
	Finishing	-	BXM10 BXM20 BXA20	0.05 - 0.5	0.05 - 0.25	70 - 350
		-	LX10 LX21	0.05 - 0.5	0.05 - 0.25	60 - 180
	Removing of carburized layer	HF	BXM20	0.3 - 0.75	0.05 - 0.3	70 - 200
		HM	BXA20 BXM20	0.5 - 1	0.05 - 0.3	70 - 200
Medium cutting	HRF	AH8005 AH8015	0.05 - 2	0.05 - 0.25	10 - 50	

Hardened steels, Pre-hardened steels: SKD11, SKD61, etc. X153CrMoV12, X40CrMoV5-1, etc.

Selection System

SELECTION SYSTEM: NEGATIVE TYPE

H Hard Materials

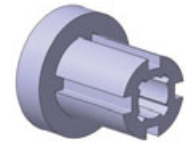
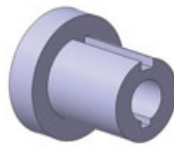
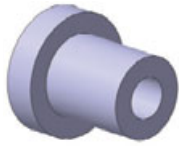

Continuous

Light interrupted

Heavy interrupted

Precision finishing
[$a_p \sim 0.35 \text{ mm}$]

Basic

High feed

HP BXA10
B168 - B188

HS BXA10
B168 - B188

Basic

Fracture

BXA20
B168 - B188

High-speed wear

BXA10
B168 - B188

Finishing
[$a_p \sim 0.5 \text{ mm}$]

Basic

High-speed

BXA10
B168 - B188

LX10
B038, B039

Basic

Fracture

BXA20
B168 - B188

High-speed

LX21
B038, B039

High-speed wear

BXA10
B168 - B188

Basic

Fracture

BR35F
B168 - B188

-HC BR35F
B168 - B188

Removing of carburized layer
[$a_p \sim 1 \text{ mm}$]

Basic

HF BXM20
B168 - B188

Basic

HM BXA20
B168 - B188

Medium cutting
[$a_p \sim 2 \text{ mm}$]

Basic

Fracture

HRF AH8005
B031

HRF AH8015
B034

Basic

Fracture

HRF AH8015
B031

HRM AH8015
B034

Basic

Fracture

HRF AH8015
B031

HRM AH8015
B034

Please see the page B*** for the details.

Chipbreaker Guide

BASIC CHIPBREAKER: POSITIVE TYPE

P Steel

Chipbreaker System for Turning (Positive Type)

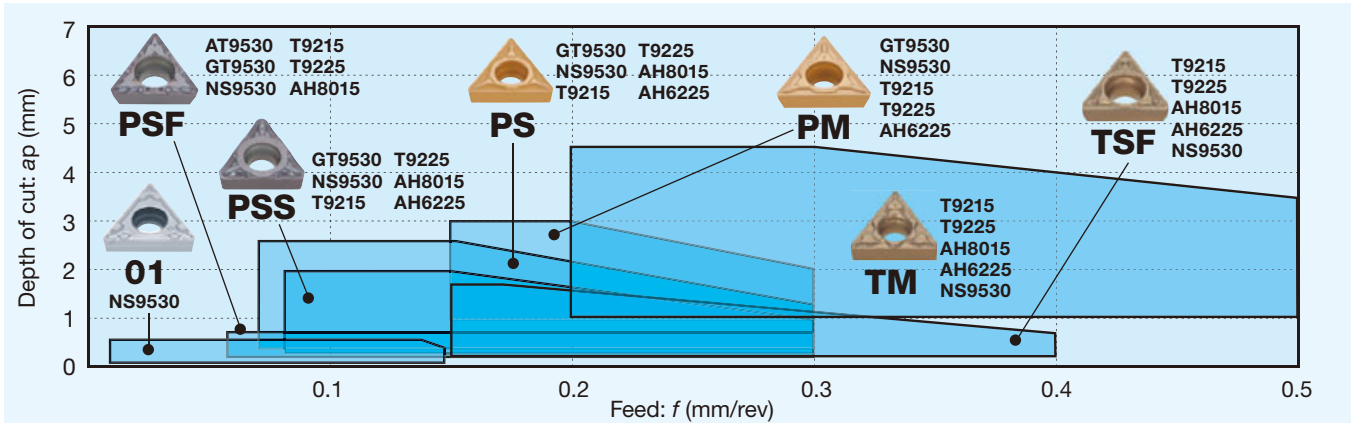

CVD / PVD coated grade

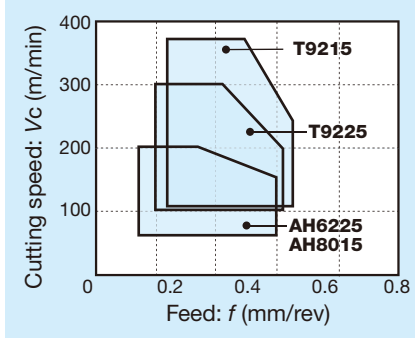

Coated cermet / Cermet

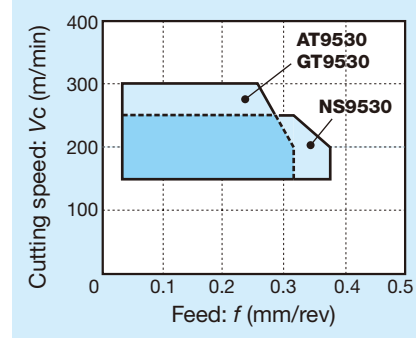

Chipbreaker	Shape	Feature
01		Excellent chip control in machining very small depth of cut thanks to the sharp cutting edge and protrusion.
PSF		Low cutting force and high wear resistance. First choice for finishing. Excellent chip control in finishing prevents chip entanglement in internal machining.
PSS		3D chipbreaker for finishing to medium cutting with excellent chip control and low cutting force.
PS		3D chipbreaker for finishing to medium cutting with excellent chip control and sharpness. M-class insert delivers cost reduction and highly efficient boring in a wide range of applications.

Chipbreaker	Shape	Feature
PM		First choice for medium cutting with excellent sharpness and good chip control. Delivers stable machining of stainless steel.
TSF		Optimal chipbreaker width and geometry enable smooth chip control in high-feed machining.
TM		Optimal cutting edge design and chipbreaker shape achieve excellent chip control in large depth of cut machining.

STANDARD CUTTING CONDITIONS

ISO	Operation	Chip-breaker	Grade	Depth of cut ap (mm)	Feed f (mm/rev)	Cutting speed: Vc (m/min)		
						Low carbon steels, Alloy steels	Medium carbon steels, Alloy steels	High carbon steels, Alloy steels
P	Precision finishing	01	NS9530	0.05 - 0.5	0.03 - 0.15	150 - 250	80 - 220	80 - 180
			NS9530	0.05 - 0.5	0.03 - 0.15	150 - 250	80 - 220	80 - 180
	Finishing	PSS	NS9530	0.1 - 0.5	0.05 - 0.3	150 - 250	80 - 220	80 - 180
		PSS	NS9530	0.1 - 0.5	0.05 - 0.3	150 - 250	80 - 220	80 - 180
	Finishing to light cutting	PS	T9215	0.3 - 2	0.08 - 0.3	120 - 350	100 - 350	80 - 250
		PS	T9215	0.3 - 2	0.08 - 0.3	120 - 350	100 - 350	80 - 250
	Finishing to Medium cutting	PS	T9215	0.5 - 2.5	0.08 - 0.3	120 - 350	100 - 350	80 - 250
		PS	T9225	0.5 - 2.5	0.08 - 0.3	100 - 300	80 - 300	80 - 250
	Medium cutting	PM	T9215	1 - 3	0.15 - 0.3	150	100 - 200	80 - 180
		PM	T9225	1 - 3	0.15 - 0.3	120	80 - 180	80 - 120

Low carbon steels, Alloy steels: S10C, SCM415, SS400, SCr420H, etc. C10, 18CrMo4, E275A, 20Cr4, etc. Medium carbon steels, Alloy steels: S45C, SCM440, etc. C45, 42CrMo4, etc. Hi carbon steels, Alloy steels: SNCM439, etc. 41CrNiMo2, etc.

Selection System

SELECTION SYSTEM: POSITIVE TYPE



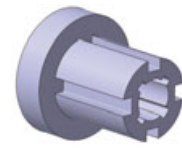
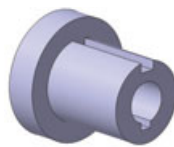





P Steel

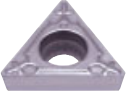

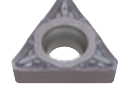
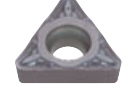
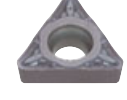
Continuous

Light interrupted

Heavy interrupted

	Continuous	Light interrupted	Heavy interrupted
Precision finishing [$a_p = \sim 0.5$ mm.]	<p>Basic</p>  <p>01 NS9530</p> <p>B040, B045</p>	<p>Basic</p>  <p>01 NS9530</p> <p>B040, B045</p> <p>Fracture → PSF NS9530 B040, B045, B049</p>	
Finishing [$a_p = 0.1 \sim 0.5$ mm.]	<p>Basic</p>  <p>PSS NS9530</p> <p>B042, B046, B049</p> <p>Fracture → PSS T9215 B042, B045, B049</p> <p>Wear → PSS GT9530 B042, B045, B049</p> <p>Chip control → PSF NS9530 B040, B045, B049</p>	<p>Basic</p>  <p>PSS NS9530</p> <p>B042, B046, B049</p> <p>Fracture → PSS T9215 B042, B046, B049</p> <p>Wear → PSS GT9530 B042, B046, B049</p> <p>Chip control → PSF NS9530 B040, B045, B049</p>	<p>Basic</p>  <p>PSS NS9530</p> <p>B042, B046, B049</p> <p>Fracture → PSS T9215 B042, B046, B049</p> <p>Wear → PSS GT9530 B042, B046, B049</p> <p>Chip control → PSF NS9530 B040, B045, B049</p>
Finishing to medium cutting [$a_p = 0.5 \sim 2.5$ mm.]	<p>Basic</p>  <p>PS T9215</p> <p>B042, B046, B049</p> <p>Fracture → PS T9225 B042, B046, B049</p> <p>Wear → PS NS9530 B042, B046, B049</p> <p>Chip control → TSF, TM T9215 B040, B042, B045, D046, B049</p>	<p>Basic</p>  <p>PS T9215</p> <p>B042, B046, B049</p> <p>Fracture → PS T9225 B042, B046, B049</p> <p>Wear → PS NS9530 B042, B046, B049</p> <p>Chip control → TSF, TM T9215 B040, B042, B045, D046, B049</p>	<p>Basic</p>  <p>PS T9215</p> <p>B042, B046, B049</p> <p>Fracture → PS T9225 B042, B046</p> <p>Chip control → TSF, TM T9215 B040, B042, B045, D046, B049</p>
Medium cutting [$a_p = 1 \sim 3$ mm.]	<p>Basic</p>  <p>PM T9215</p> <p>B044, B048</p> <p>Fracture → PM T9225 B044, B048</p> <p>Wear → PM NS9530 B044, B048</p> <p>Chip control → TSF, TM T9215 B040, B042, B045, D046, B049</p>	<p>Basic</p>  <p>PM T9215</p> <p>B044, B048</p> <p>Fracture → PM T9225 B044, B048</p> <p>Chip control → TSF, TM T9215 B040, B042, B045, D046, B049</p>	<p>Basic</p>  <p>PM T9215</p> <p>B044, B048</p> <p>Fracture → PM T9225 B044, B048</p> <p>Chip control → TSF, TM T9215 B040, B042, B045, D046, B049</p>

Please find the details on the pages: B***/7° relief angle, B***/11° relief angle, B***/5° relief angle.



Chipbreaker Guide

BASIC CHIPBREAKER: POSITIVE TYPE

M Stainless Steel

Chipbreaker System for Turning (Positive Type)

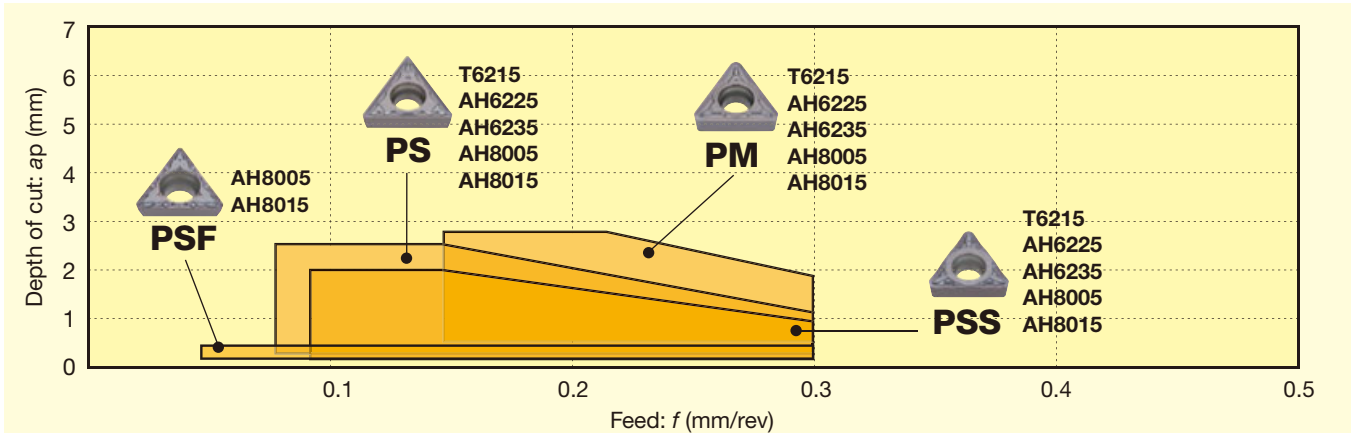

Austenitic stainless steel

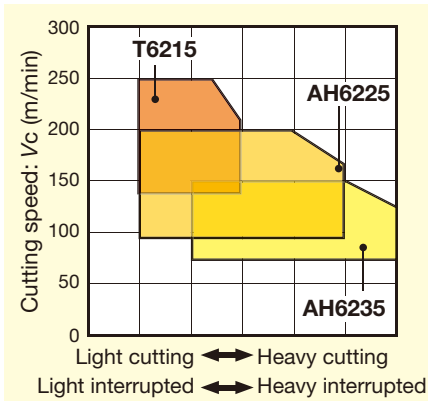

Ferritic / martensite stainless steel

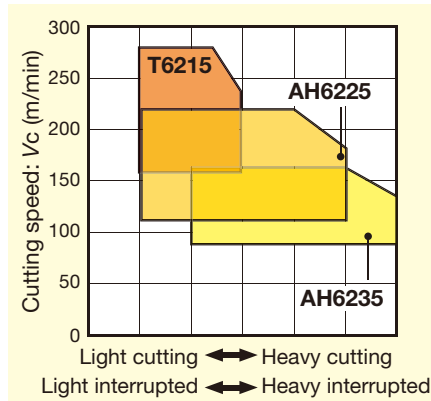

Precipitation hardened stainless steel

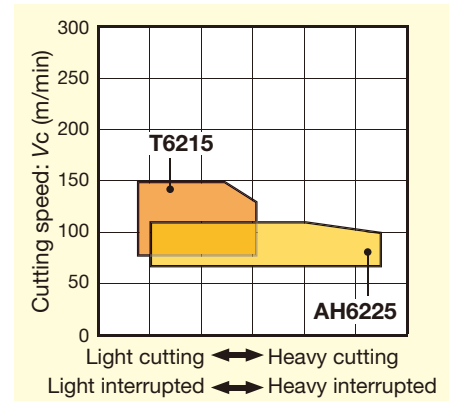

Chipbreaker	Shape	Feature
PSF		Low cutting force and high wear resistance. First choice for finishing. Excellent chip control in finishing prevents chip entanglement in internal machining.
PSS		3D chipbreaker for finishing to medium cutting with excellent chip control and low cutting force.

Chipbreaker	Shape	Feature
PS		3D chipbreaker for finishing to medium cutting with excellent chip control and sharpness. M-class insert delivers cost reduction and highly efficient boring in a wide range of applications.
PM		First choice for medium cutting with excellent sharpness and good chip control. Delivers stable machining of stainless steel.

STANDARD CUTTING CONDITIONS

ISO	Operation	Chipbreaker	Grade	Depth of cut ap (mm)	Feed f (mm/rev)	Cutting speed: Vc (m/min)		
						Austenitic stainless steel	Ferritic / martensite stainless steel	Precipitation hardened stainless steel
M	Finishing	PSS	T6215	0.3 - 2	0.08 - 0.3	140 - 240	160 - 280	80 - 150
			AH6225	0.3 - 2	0.08 - 0.3	90 - 200	110 - 240	60 - 110
			AH6235	0.3 - 2	0.08 - 0.3	50 - 150	70 - 170	-
	Finishing to medium cutting	PS	T6215	0.5 - 2.5	0.08 - 0.3	140 - 240	160 - 280	80 - 150
			AH6225	0.5 - 2.5	0.08 - 0.3	90 - 200	110 - 240	60 - 110
			AH6235	0.5 - 2.5	0.08 - 0.3	50 - 150	70 - 170	-
Medium cutting	PM	T6215	1 - 3	0.15 - 0.3	140 - 240	160 - 280	80 - 150	
		AH6225	1 - 3	0.15 - 0.3	90 - 200	110 - 240	60 - 110	
		AH6235	1 - 3	0.15 - 0.3	50 - 150	70 - 170	-	

* For CCMT0602 and DCMT0702 type inserts, ap = 0.5 - 2.5
Stainless steels: SUS304, SUS316, etc. X5CrNi18-9, X5CrNiMo17-12-3, etc.

Selection System

SELECTION SYSTEM: POSITIVE TYPE

M Stainless Steel

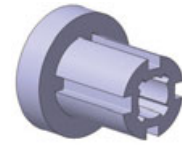
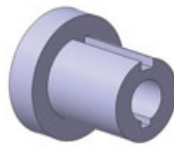
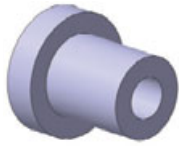

Continuous

Light interrupted

Heavy interrupted

	Continuous	Light interrupted	Heavy interrupted
Finishing [$a_p = 0.3 \sim 1.5 \text{ mm}$]	Basic  PSS AH6225 B042, B046, B049 Wear → PSS T6215 B042, B046, B049	Basic  PSS AH6225 B042, B046, B049 Fracture → PSS AH6235 B042, B046, B049 Wear → PSS T6215 B042, B046, B049	Basic  PSS AH6225 B042, B046, B049 Fracture → PSS AH6235 B042, B046, B049 Wear → PSS T6215 B042, B046, B049
Finishing to medium cutting [$a_p = 0.5 \sim 2.5 \text{ mm}$]	Basic  PS AH6225 B042, B046, B049 Wear → PS T6215 B042, B046, B049	Basic  PS AH6225 B042, B046, B049 Fracture → PM AH6235 B044, B048 Wear → PS T6215 B042, B046, B049	Basic  PS AH6225 B042, B046, B049 Fracture → PM AH6235 B044, B048 Wear → PS T6215 B042, B046, B049
Medium cutting [$a_p = 1 \sim 3 \text{ mm}$]	Basic  PM AH6225 B044, B048 Wear → PM T6215 B044, B048	Basic  PM AH6225 B044, B048 Fracture → PM AH6235 B044, B048 Wear → PM T6215 B044, B048	Basic  PM AH6225 B044, B048 Fracture → PM AH6235 B044, B048

Please find the details on the pages: B***/7° relief angle, B***/11° relief angle, B***/5° relief angle.

Grade
 Insert
 Ext. Toolholder
 Int. Toolholder
 Threading
 Grooving
 Milling cutter
 Miniature tool
 Endmill
 Drilling tool
 Tooling System
 User's Guide
 Index



Chipbreaker Guide

BASIC CHIPBREAKER: POSITIVE TYPE

K Cast Iron

Chipbreaker System for Turning (Positive Type)

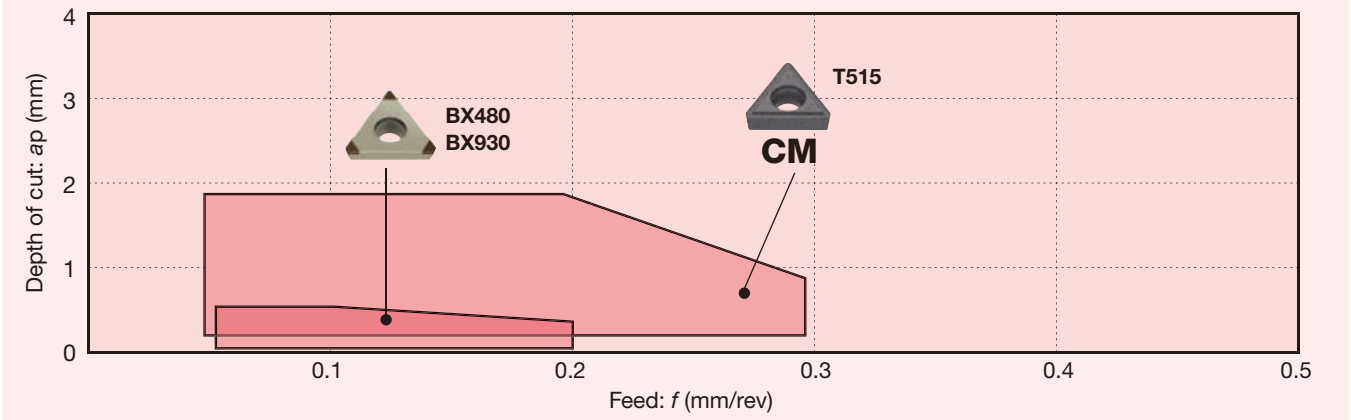

Grey cast iron

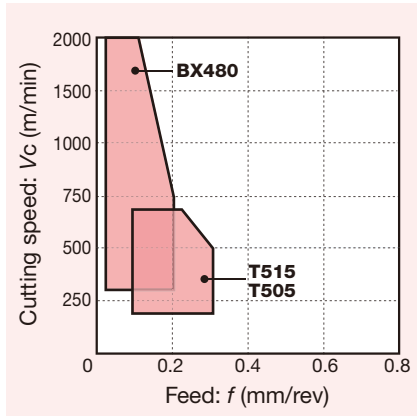

Ductile cast iron

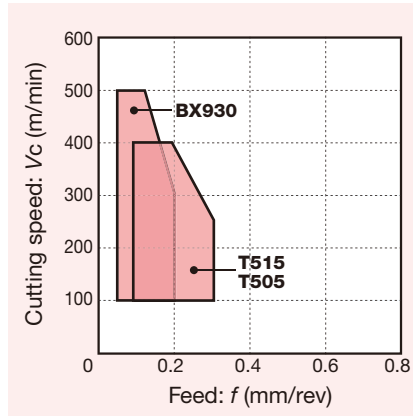

Chipbreaker	Shape	Feature
-		Excellent performance in high-speed finishing of cast iron with CBN sintered body on the cutting edge.

Chipbreaker	Shape	Feature
CM		Highly versatile all-round chipbreaker with low cutting force. Suitable for finishing to medium cutting.

STANDARD CUTTING CONDITIONS

ISO	Operation	Chip-breaker	Grade	Depth of cut ap (mm)	Feed f (mm/rev)	Cutting speed: Vc (m/min)	
						Grey cast iron	Ductile cast iron
K	Precision finishing	-	BX930	0.05 - 0.5	0.05 - 0.2	300 - 1200	100 - 500
		-	BX480	0.05 - 0.5	0.05 - 0.2	300 - 2000	-
	Finishing	CM	T515	0.05 - 2	0.05 - 0.3	150 - 700	150 - 300
		CM	T515	0.05 - 2	0.05 - 0.3	100 - 200	100 - 200
		CM	T515	0.05 - 2	0.05 - 0.3	100 - 300	100 - 250
Medium cutting	CM	T515	0.05 - 2	0.05 - 0.3	100 - 300	100 - 250	

Grey cast iron: FC250, etc. 250, etc.

Ductile cast iron: FCD450, etc. 450-10S, etc.

Selection System

SELECTION SYSTEM: POSITIVE TYPE

K Cast Iron

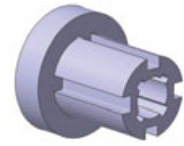
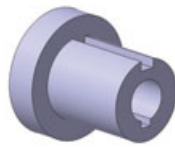
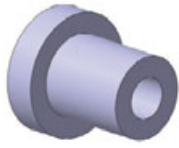

Continuous

Light interrupted

Heavy interrupted

Precision finishing
[$a_p = \sim 0.5 \text{ mm}$]

Basic



-
BX480

B189 - B209

Basic



-
BX480

B189 - B209

Finishing to Medium cutting
[$a_p = 0.5 \sim 3 \text{ mm}$]

Basic



CM T515

B042, B046, B049



CM T505

B042, B046, B049

Basic



CM T515

B042, B046, B049



CM T505

B042, B046, B049

Basic



CM T515

B042, B046, B049



CM T505

B042, B046, B049

Please find the details on the pages: **B**/7°** relief angle, **B**/11°** relief angle, **B**/5°** relief angle.

Grade

Insert

Ext. Toolholder

Int. Toolholder

Threading

Grooving

Miniature tool

Milling cutter

Endmill

Drilling tool

Tooling System

User's Guide

Index

Chipbreaker Guide

BASIC CHIPBREAKER: POSITIVE TYPE

N Non-ferrous Metal

Chipbreaker System for Turning (Positive Type)

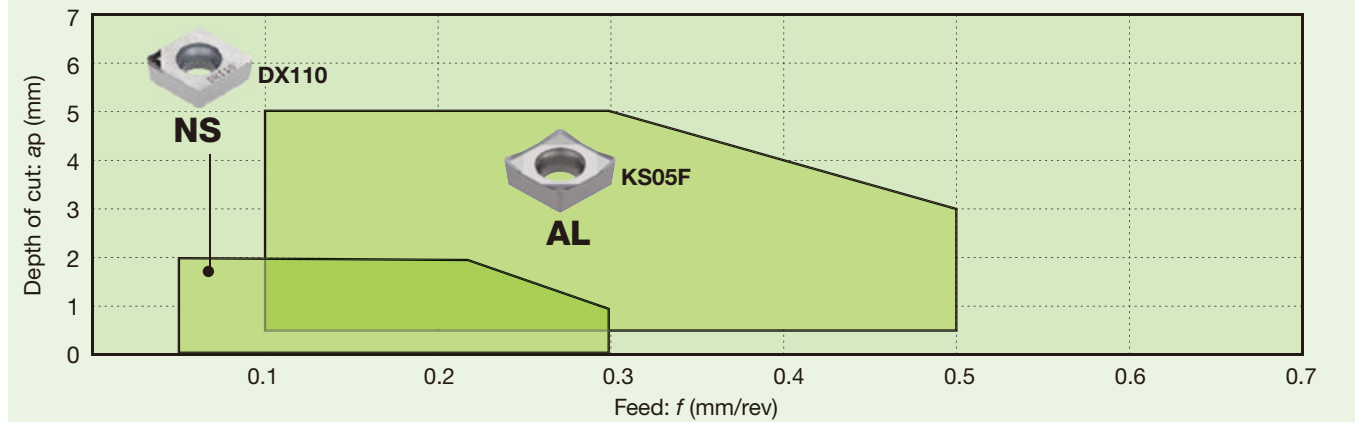

Aluminium alloy (Si < 12%)

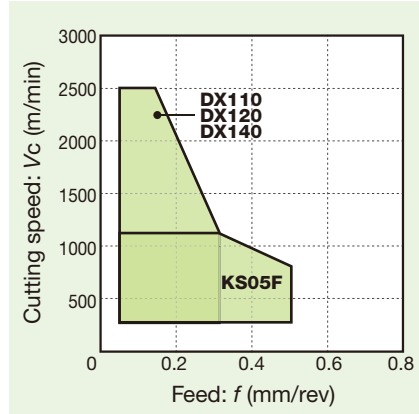

Aluminium alloy (Si ≥ 12%)

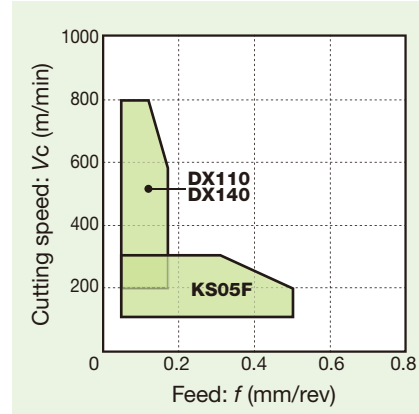

Copper alloy

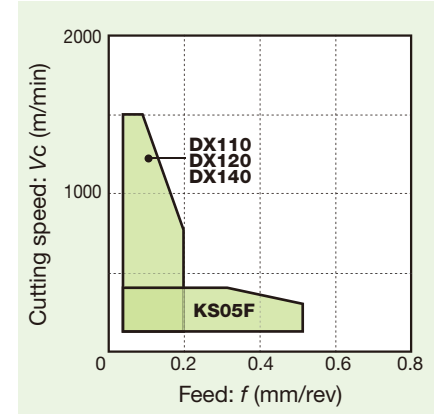

Chipbreaker	Shape	Feature
-		Excellent performance in high-speed finishing of non-ferrous metal with diamond sintered body on the cutting edge.
AL		Large rake angle and sharp cutting edge reduce cutting force. Lapped rake face prevents adhesion. Large inclination on the cutting edge (wavy cutting edge) for more stable chip control.

Chipbreaker	Shape	Feature
NS		A unique three-dimensional chipbreaker. Covers a wide range of condition from roughing to finishing.

STANDARD CUTTING CONDITIONS

ISO	Operation	Work condition	Chip-breaker	Grade	Depth of cut ap (mm)	Feed f (mm/rev)	Cutting speed: Vc (m/min)		
							Aluminium alloy (Si < 12%)	Aluminium alloy (Si ≥ 12%)	Copper alloy
N	Precision finishing	Continuous	NS	DX110	0.05 - 2	0.05 - 0.15	500 - 2500	400 - 800	500 - 1500
		Light interrupted	-	DX140	0.05 - 1	0.05 - 0.2	300 - 2500	-	500 - 1500
	Finishing	Continuous	NS	DX110	0.05 - 2	0.05 - 0.3	500 - 2500	400 - 800	500 - 1500
		Light interrupted	-	DX140	0.05 - 1	0.05 - 0.15	300 - 1800	400 - 600	400 - 1200
		Heavy interrupted	AL	KS05F	0.5 - 5	0.1 - 0.5	100 - 600	100 - 200	-
	Medium cutting	Continuous	AL	KS05F	0.5 - 5	0.1 - 0.5	100 - 1200	100 - 300	100 - 300
Light interrupted		AL	KS05F	0.5 - 5	0.1 - 0.5	100 - 900	100 - 200	100 - 200	
Heavy interrupted		AL	KS05F	0.5 - 5	0.1 - 0.5	100 - 600	100 - 200	-	

Selection System

SELECTION SYSTEM: POSITIVE TYPE



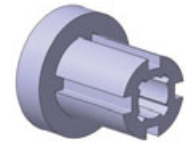
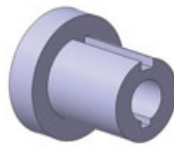
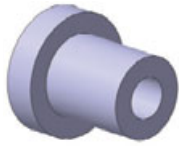





N Non-ferrous Metal

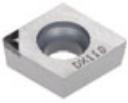

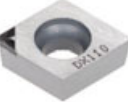
Continuous

Light interrupted

Heavy interrupted

	Continuous	Light interrupted	Heavy interrupted
Precision finishing [$a_p = \sim 0.5 \text{ mm}$]	<p>Basic</p>  <p>Wear → DX140 B213 -</p>	<p>Basic</p>  <p>Wear → DX140 B213 -</p>	
Finishing [$a_p = 0.5 \sim 2 \text{ mm}$]	<p>Basic</p>  <p>Wear → DX160 B213 -</p>	<p>Basic</p>  <p>Fracture → AL KS05F B042</p> <p>Wear → DX160 B213 -</p>	<p>Basic</p>  <p>AL KS05F B043</p>
Medium cutting [$a_p = 1 \sim 5 \text{ mm}$]	<p>Basic</p>  <p>Wear → With chipbreaker DX120 B213 -</p> <p>AL KS05F B043</p>	<p>Basic</p>  <p>Wear → DX140 B213 -</p> <p>AL KS05F B043</p>	<p>Basic</p>  <p>AL KS05F B043</p>

Grade

Insert

Ext. Toolholder

Int. Toolholder

Threading

Grooving

Miniature tool

Milling cutter

Endmill

Drilling tool

Tooling System

User's Guide

Index

Chipbreaker Guide

BASIC CHIPBREAKER: POSITIVE TYPE

S Heat resistant superalloys

Chipbreaker System for Turning (Positive Type)

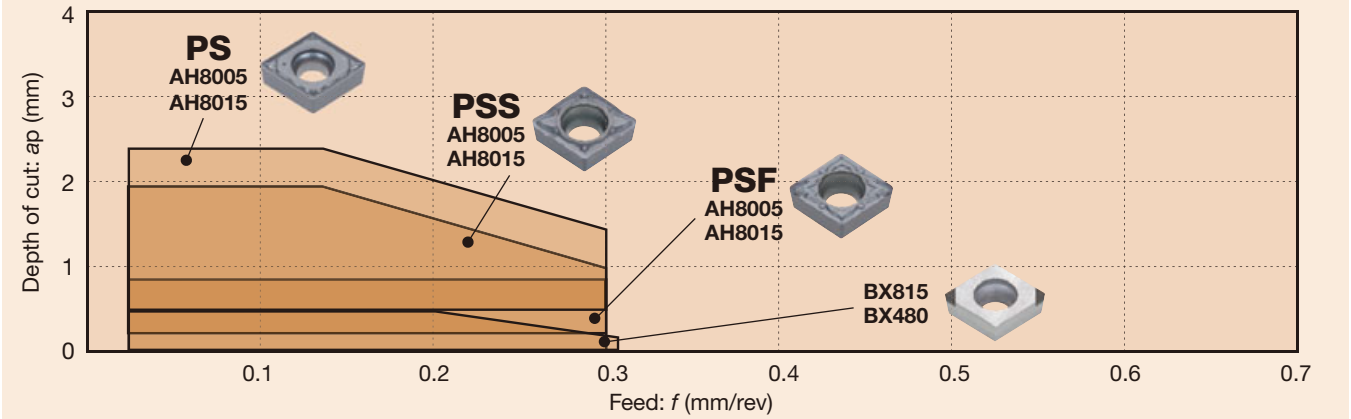

Titanium alloy

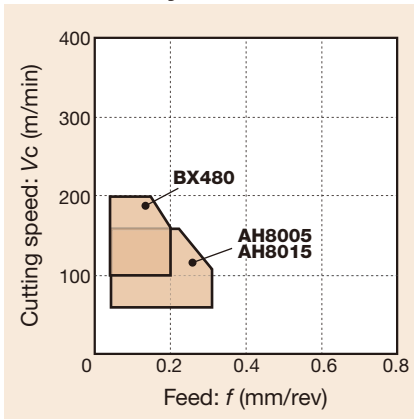

Ni-base alloy

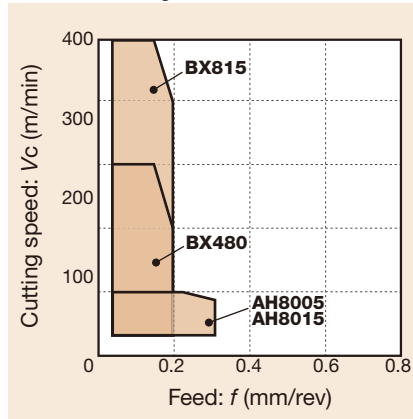

Chipbreaker	Shape	Feature
PS		3D chipbreaker for finishing to medium cutting with excellent chip control and sharpness. M-class insert delivers cost reduction and highly efficient boring in a wide range of applications.
-		Excellent performance in finishing of heat-resistant alloy and titanium alloy with CBN sintered body on the cutting edge.

Chipbreaker	Shape	Feature
PSF		Low cutting force and high wear resistance. First choice for finishing. Excellent chip control in finishing prevents chip entanglement in internal machining.
PSS		3D chipbreaker for finishing to medium cutting with excellent chip control and low cutting force.

STANDARD CUTTING CONDITIONS

ISO	Operation	Chip-breaker	Grade	Depth of cut ap (mm)	Feed f (mm/rev)	Cutting speed: Vc (m/min)	
						Titanium alloy	Ni-base alloy
S	Precision finishing	-	BX480	0.1 - 0.5	0.05 - 0.2	100 - 200	70 - 300
		-	BX815	0.1 - 0.5	0.05 - 0.2	-	70 - 500
	Finishing	PSS	AH8015	0.3 - 2	0.02 - 0.3	20 - 150	20 - 100
		PSS	AH8015	0.3 - 2	0.02 - 0.3	20 - 150	20 - 100
	Finishing to medium cutting	PS	AH8015	0.5 - 2.5	0.02 - 0.3	20 - 150	20 - 100
		PS	AH8015	0.5 - 2.5	0.02 - 0.3	20 - 150	20 - 100

Ni-base alloy: INCONEL718, etc. Titanium alloy: Ti-6Al-4V, etc.

Selection System

SELECTION SYSTEM: POSITIVE TYPE

S Heat resistant superalloys

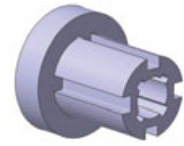
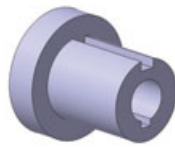
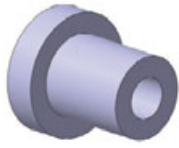

Continuous

Light interrupted

Heavy interrupted

Precision finishing
[$a_p \sim 0.5 \text{ mm}$]

Basic



BX815

B189 - B209

Basic

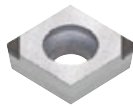

BX480

B189 - B209

Finishing
[$a_p = 0.3 \sim 2 \text{ mm}$]

Basic

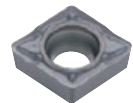

PSS AH8015

B042, B046, B049



PSS AH8005

B042, B046, B049

Basic

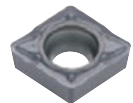

PSS AH8015

B042, B046, B049



PSS AH8005

B042, B046, B049



PS AH8015

B042, B046, B049

Finishing to medium cutting
[$a_p = 0.5 \sim 2.5 \text{ mm}$]

Basic



PS AH8015

B042, B046, B049



PSS AH8005

B042, B046, B049

Basic

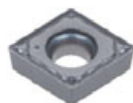

PS AH8015

B042, B046, B049



All-round AH8015

B043, B047

Basic

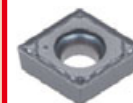

PS AH8015

B042, B046, B049



All-round AH8015

B043, B047

Please find the details on the pages: B***/7° relief angle, B***/11° relief angle, B***/5° relief angle.

Grade

Insert

Ext. Toolholder

Int. Toolholder

Threading

Grooving

Miniature tool

Milling cutter

Endmill

Drilling tool

Tooling System

User's Guide

Index

Chipbreaker Guide

BASIC CHIPBREAKER: POSITIVE TYPE

H Hard Materials

Chipbreaker System for Turning (Positive Type)

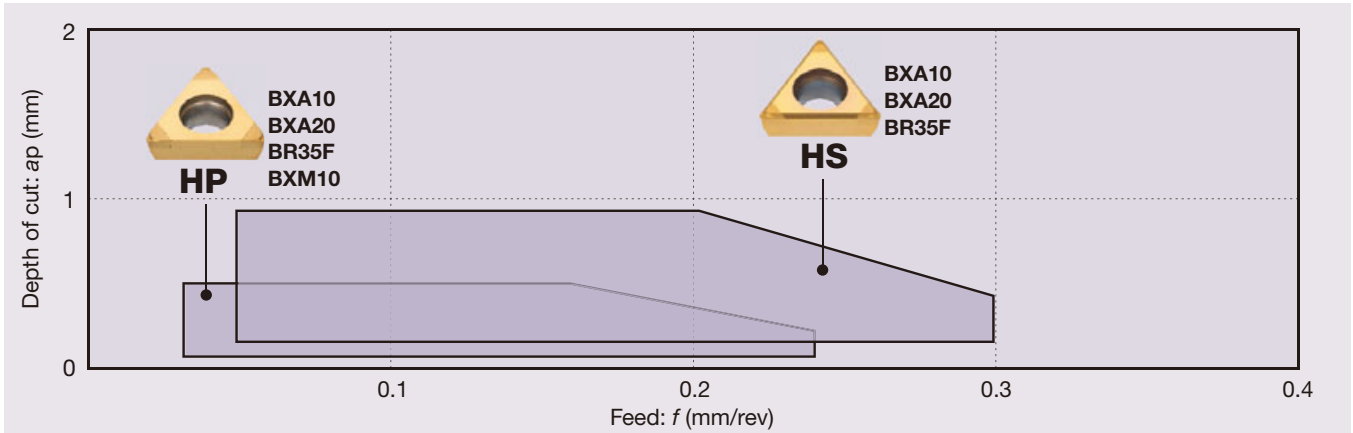

Coated CBN

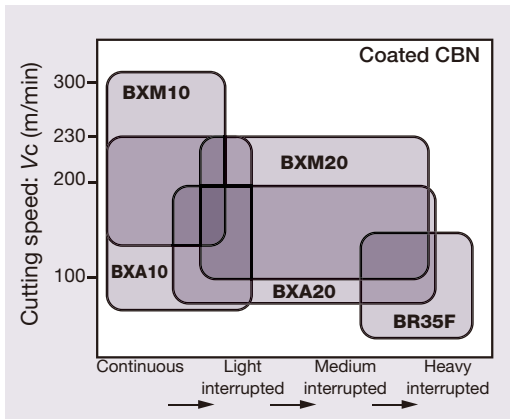

CBN

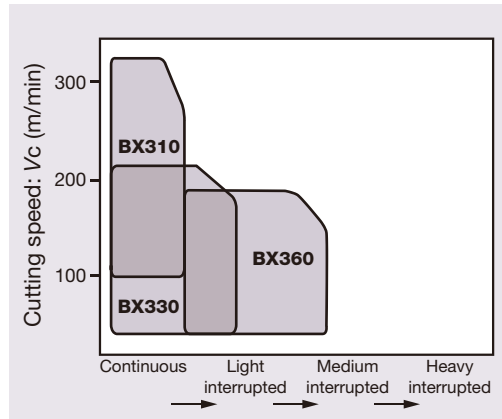

Chipbreaker	Shape	Feature	Chipbreaker	Shape	Feature
-		Excellent performance in high-speed finishing of hard material with CBN sintered body on the cutting edge.	HP		Excellent chip control in precision finishing.
			HS		Provides the excellent chip-control at a high-feed condition in the precise finishing operation.

STANDARD CUTTING CONDITIONS

ISO	Operation	Chipbreaker	Grade	Depth of cut a_p (mm)	Feed f (mm/rev)	Cutting speed V_c (m/min)
H	Precision finishing	HP	BXM10 BXA20 BR35F	0.03 - 0.25	0.03 - 0.22	70 - 350
		HS	BXM10 BXA20 BR35F	0.1 - 0.35	0.05 - 0.3	70 - 350
	Finishing	-	BXM10 BXA20 BR35F	0.05 - 0.5	0.05 - 0.25	70 - 350

Hardened steels, Pre-hardened steels: SKD11, SKD61, etc. X153CrMoV12, X40CrMoV5-1, etc.

Selection System

SELECTION SYSTEM: POSITIVE TYPE



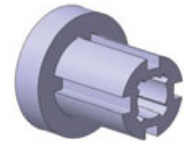
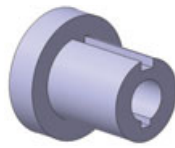
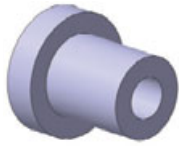

H Hard Materials



Continuous

Light interrupted

Heavy interrupted

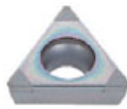
	Continuous	Light interrupted	Heavy interrupted
Precision finishing [$a_p \sim 0.35 \text{ mm}$]	<p>Basic</p>  <p>HP BXA10 B189 -</p> <p>High-feed →</p> <p>HS BXA10 B189 -</p>	<p>Basic</p>  <p>BXA20 B189 -</p> <p>Fracture →</p> <p>-H BXA20 B189 -</p>	
Finishing [$a_p \sim 0.5 \text{ mm}$]	<p>Basic</p>  <p>BXA10 B189 -</p>	<p>Basic</p>  <p>BXA20 B189 -</p> <p>Fracture →</p> <p>-H BXA20 B189 -</p> <p>High-speed wear →</p> <p>BXA10 B189 -</p>	<p>Basic</p>  <p>SR BR35F B189 -</p> <p>Fracture →</p> <p>HC BR35F B189 -</p>

Grade

Insert

Ext. Toolholder

Int. Toolholder

Threading

Grooving

Miniature tool

Milling cutter

Endmill

Drilling tool

Tooling System

User's Guide

Index

Chipbreaker Guide

For Miniature machining

BASIC CHIPBREAKER: POSITIVE TYPE

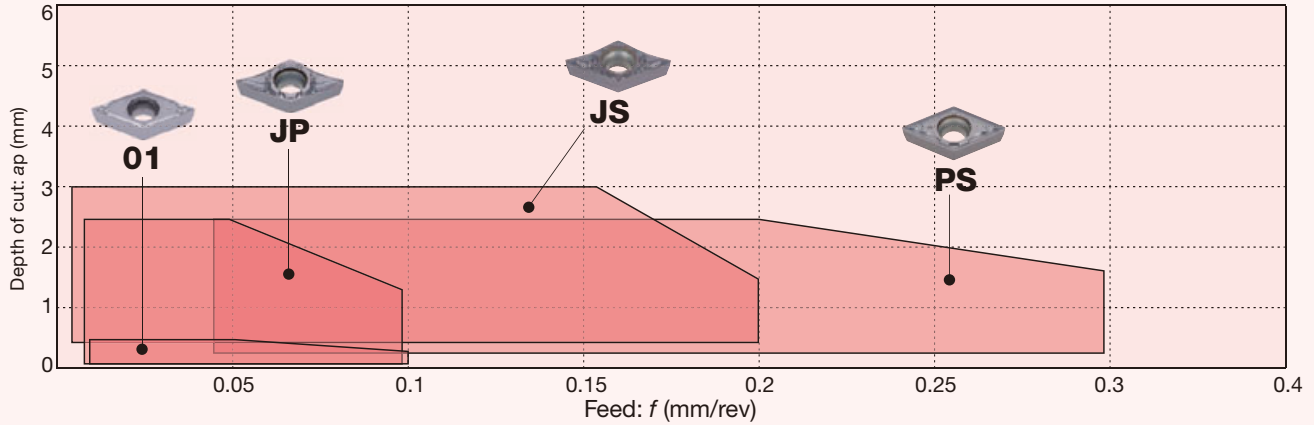

Chipbreaker	Shape	Feature	Chipbreaker	Shape	Feature
JP		Excellent performance in finishing of hard material with CBN sintered body on the cutting edge.	JS		Excellent chip control in removing carburized layer at small depth of cut.

BASIC CHIPBREAKER: DOUBLE-SIDED POSITIVE TYPE

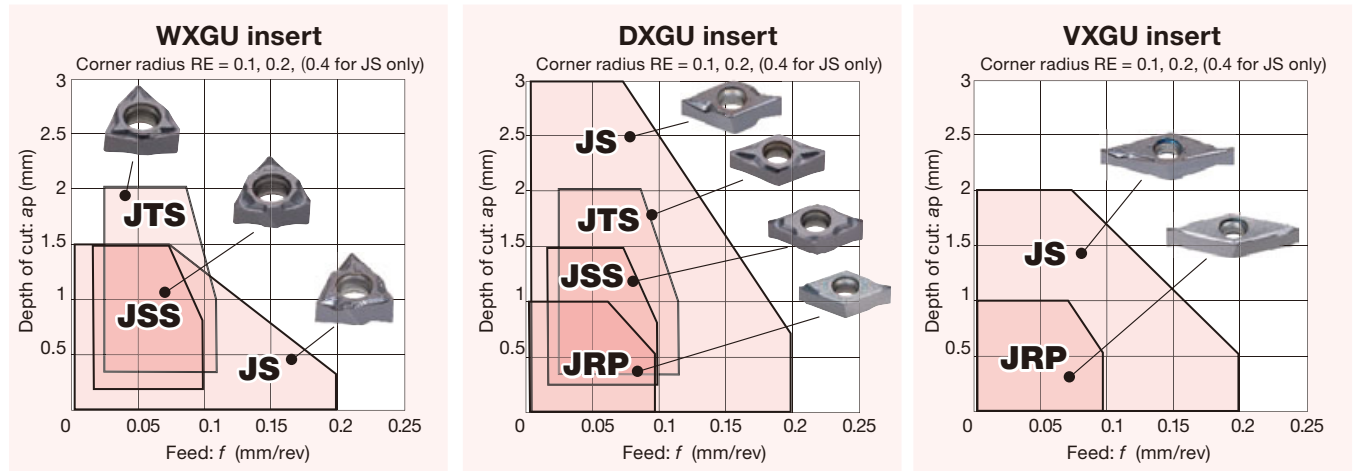

STANDARD CUTTING CONDITIONS POSITIVE TYPE

Operation	Chip-breaker	Grade	Depth of cut ap (mm)	Feed f (mm/rev)	Cutting speed Vc (m/min)
Precision finishing	JP	SH725	0.05 - 2.5	0.02 - 0.1	10 - 200
Finishing	JP	SH725	0.05 - 2.5	0.02 - 0.1	50 - 250
	JS	SH725	0.2 - 3	0.02 - 0.2	10 - 200
Finishing to light cutting	JP	SH725	0.05 - 2.5	0.02 - 0.1	50 - 250
	JS	SH725	0.5 - 2	0.02 - 0.2	10 - 200
Medium cutting	JS	SH725	0.5 - 3	0.03 - 0.15	10 - 200
	PS	AH8015	0.5 - 2.5	0.02 - 0.2	20 - 200
	PS	AH6225	0.5 - 2.5	0.02 - 0.2	60 - 240

STANDARD CUTTING CONDITIONS DOUBLE-SIDED POSITIVE TYPE

Operation	Chip-breaker	Grade	Depth of cut ap (mm)	Feed f (mm/rev)	Cutting speed Vc (m/min)
Precision finishing	JRP	SH725	0.05 - 0.5	0.03 - 0.08	50 - 250
Finishing	JSS	SH725	0.2 - 1.5	0.03 - 0.1	50 - 250
	JS	SH725	0.2 - 3	0.03 - 0.2	50 - 250
Finishing to light cutting	JS	SH725	0.5 - 3	0.03 - 0.2	50 - 250
	JTS	SH725	0.5 - 2	0.03 - 0.1	50 - 250
Medium cutting	JS	SH725	0.5 - 3	0.03 - 0.2	50 - 250

Selection System

SELECTION SYSTEM: POSITIVE TYPE/DOUBLE-SIDED POSITIVE TYPE

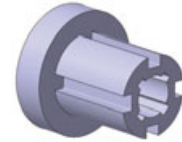
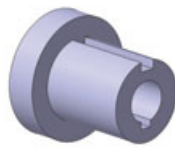

Continuous

Light interrupted



















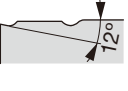
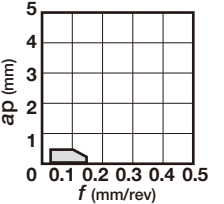





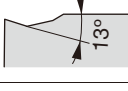
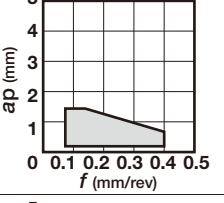







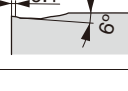
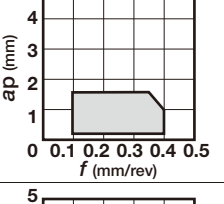





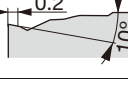
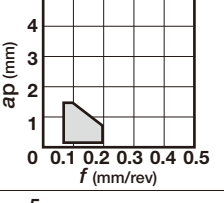







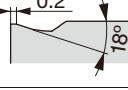
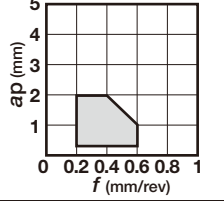





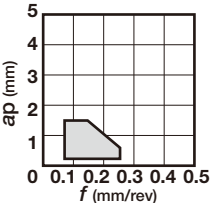

Heavy interrupted

	Continuous	Light interrupted	Heavy interrupted
Precision finishing [$a_p = \sim 0.5$ mm]	<p>Basic Positive</p> <p>JP SH725</p> <p>Double-sided positive</p> <p>JRP SH725</p> <p>B040, B052</p>	<p>Basic Positive</p> <p>JP SH725</p> <p>Double-sided positive</p> <p>JRP SH725</p> <p>B040, B052</p>	
Finishing [$a_p = 0.1 \sim 0.5$ mm]	<p>Basic Positive</p> <p>JS SH725</p> <p>Double-sided positive</p> <p>JSS AH725</p> <p>B040, B045, B049, B052</p> <p>Chip control → JP SH725 (B040)</p> <p>Fracture → JSS AH725 (B052)</p>	<p>Basic Positive</p> <p>JS SH725</p> <p>Double-sided positive</p> <p>JSS AH725</p> <p>B040, B045, B049, B052</p> <p>Chip control → JP SH725 (B040)</p> <p>Fracture → JSS AH725 (B052)</p>	<p>Basic Positive</p> <p>JS SH725</p> <p>Double-sided positive</p> <p>JSS AH725</p> <p>B040, B045, B049, B052</p>
Finishing to medium cutting [$a_p = 0.5 \sim 3$ mm]	<p>Basic Positive</p> <p>JS SH725</p> <p>Double-sided positive</p> <p>JTS SH725</p> <p>B040, B045, B049, B052</p> <p>Chip control → JP SH725 (B040)</p> <p>Fracture → JSS AH725 (B052)</p>	<p>Basic Positive</p> <p>JS SH725</p> <p>Double-sided positive</p> <p>JTS SH725</p> <p>B040, B045, B049, B052</p> <p>Chip control → JP SH725 (B040)</p> <p>Fracture → JSS AH725 (B052)</p>	<p>Basic Positive</p> <p>JS AH725</p> <p>Double-sided positive</p> <p>JTS AH8015</p> <p>B040, B045, B049, B052</p> <p>Fracture → TS AH8015 (B052)</p>
Medium cutting [$a_p = 1 \sim 4$ (3) mm]	<p>Basic Positive</p> <p>JS SH725</p> <p>Double-sided positive</p> <p>JS SH725</p> <p>B040, B045, B049, B052</p> <p>Fracture → PS AH8015 AH6225 (B042, B046, B049)</p> <p>Fracture → JSS AH725 (B052)</p>	<p>Basic Positive</p> <p>PS AH8015 AH6225</p> <p>Double-sided positive</p> <p>JS SH725</p> <p>B042, B046, B049, B052</p> <p>Fracture → JTS AH725 (B052)</p>	<p>Basic Positive</p> <p>PS AH8015 AH6225</p> <p>Double-sided positive</p> <p>JS SH725</p> <p>B042, B046, B049, B052</p>

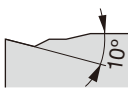
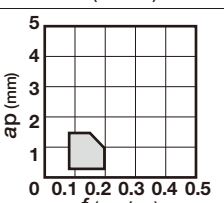
Please find the details on the pages: B***/7° relief angle, B***/11° relief angle, B***/5° relief angle, B***/Double-sided.







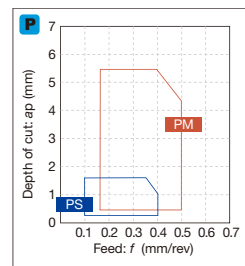
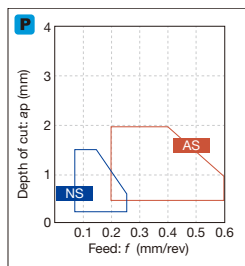
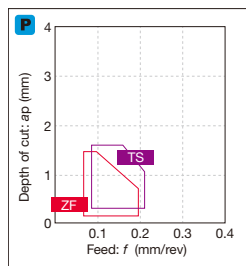
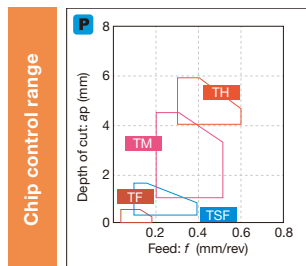



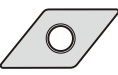

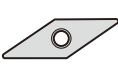

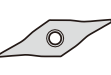
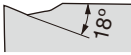
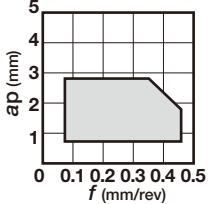





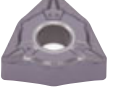

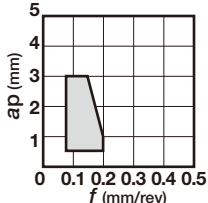







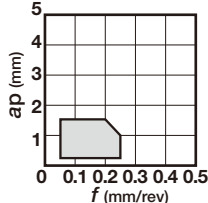





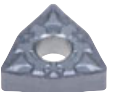

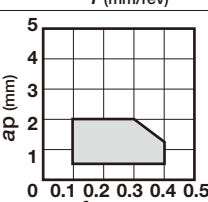







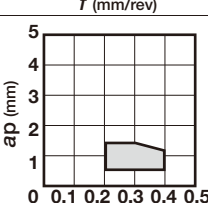





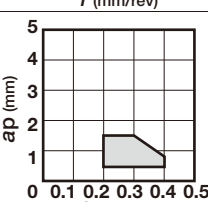

Chipbreaker Overview

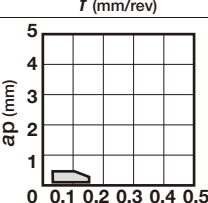
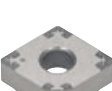
Application	Negative type with hole	C	D	F	G	S	T	V	W	Y	
											
		80°	55°	45°	70°	90°	60°	35°	80°	25°	
Finishing	TF  										
		B054	B066			B077	B087	B098	B102		
	TSF  										
	B054	B066	B075	B075	B077	B087	B098	B102			
	PS  										
	B054	B066			B077	B087	B098	B102			
Finishing for mild steel	ZF  										
		B054	B066			B077	B087	B098	B102	B110	
Finishing	AS  										
		B054	B066			B077	B087		B102		
	NS  										
	B054	B066			B077	B087		B102			
	TS  										
	B054	B067			B078	B089	B098	B103			

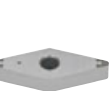

Please see the page B*** for the product details.

Application	Negative type with hole	C	D	S	T	V	W	Y
								
		80°	55°	90°	60°	35°	80°	25°
Finishing	SF  							
	SS  							
	HRF  							
	CF  							
Finishing (wiper)	FW  							
	AFW  							
Finishing	01  							

Chip control range

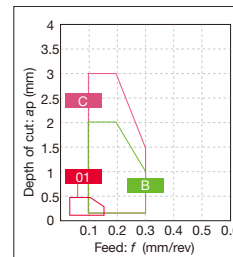
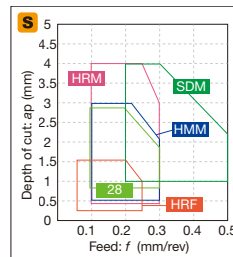
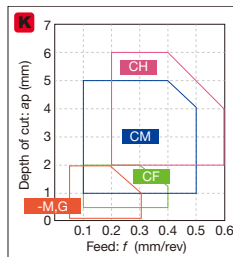
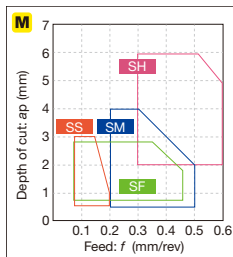
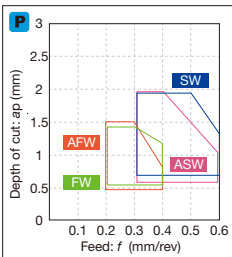

Please see the page B*** for the product details.







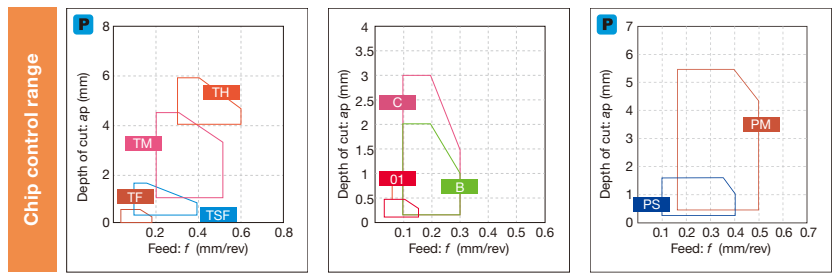



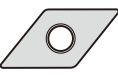

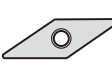

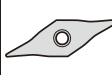
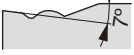



































*M.G: Without chipbreaker

Chipbreaker Overview

Application	Negative type with hole	C	D	F	G	S	T	V	W
		80°	55°	45°	70°	90°	60°	35°	80°
Finishing	11 ap (mm) vs f (mm/rev) graph	 B056	 B068			 B078	 B089	 B099	 B104
Finishing for mild steel	17 ap (mm) vs f (mm/rev) graph	 B056	 B068			 B079	 B089		 B104
Boring (double side)	CB ap (mm) vs f (mm/rev) graph	 B056	 B068				 B089		 B104
Finishing	A~D ap (mm) vs f (mm/rev) graph	 B056				 B079	 B090		
Finishing	W ap (mm) vs f (mm/rev) graph						 B090		
Medium cutting	TM ap (mm) vs f (mm/rev) graph	 B057	 B069	 B075	 B075	 B079	 B090	 B099	 B105
	PM ap (mm) vs f (mm/rev) graph	 B057	 B069			 B079	 B091	 B099	 B105



Please see the page B*** for the product details.

Application	Negative type with hole	C	D	S	T	V	W	Y
								
		80°	55°	90°	60°	35°	80°	25°
Medium cutting for mild steel	ZM 	 B057	 B069	 B080	 B091	 B099	 B105	 B110
	AM 	 B058	 B069		 B091		 B106	
	NM 	 B058	 B070		 B091		 B106	
	DM 	 B058	 B070	 B080	 B092	 B100	 B106	
	All-round 	 B058	 B070	 B080	 B092	 B100	 B106	
	SM 	 B059	 B070	 B080	 B092	 B100	 B106	
	SDM 	 B059	 B070	 B080	 B092	 B100	 B106	

Chip control range

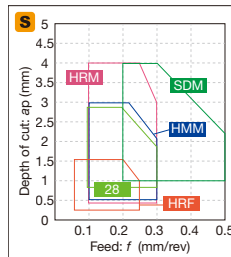
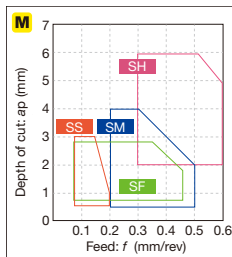
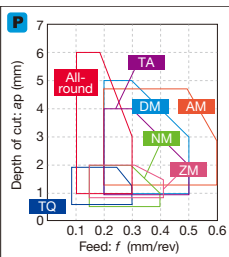

Please see the page B*** for the product details.





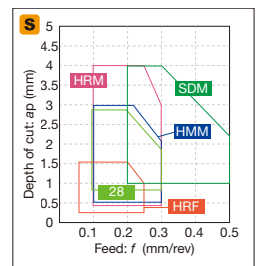
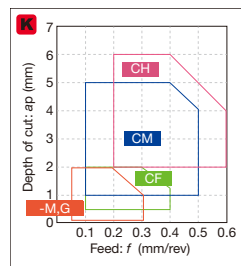
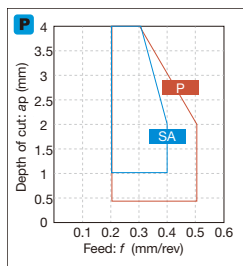
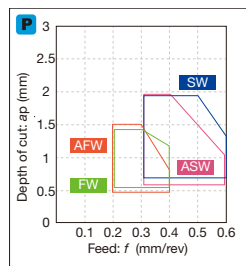
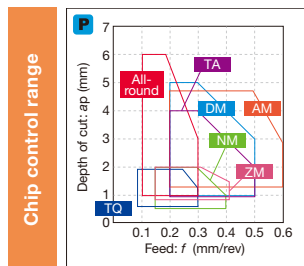





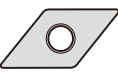

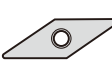

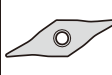
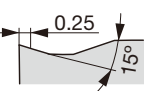
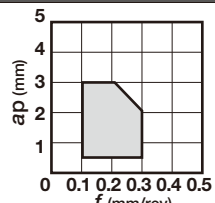





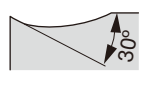
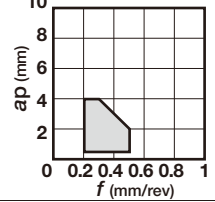
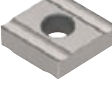



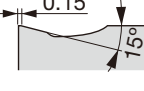
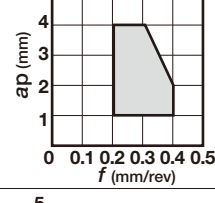



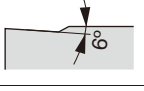
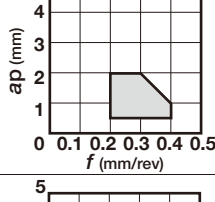





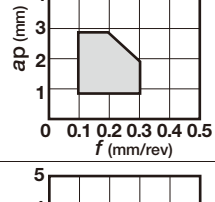



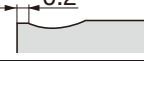
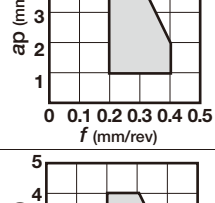

Chipbreaker Overview

Application	Negative type with hole	C	D	S	T	V	W	Y
		80°	55°	90°	60°	35°	80°	25°
Medium cutting	HRM 	 B059	 B070	 B081	 B092	 B100	 B106	
	CM 	 B059	 B071	 B080	 B092	 B100	 B107	
Medium cutting (wiper)	SW 	 B059	 B071		 B093		 B107	
	ASW 	 B060					 B107	
Medium cutting	TQ 	 B060	 B071		 B093	 B100	 B107	
	TA 	 B060		 B081	 B093		 B107	
	SA 	 B060	 B071	 B081	 B093		 B108	

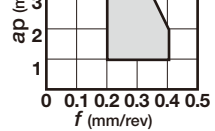

Please see the page B*** for the product details.

*-M,G: Without chipbreaker

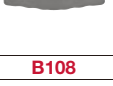
Application	Negative type with hole	C	D	S	T	V	W	Y	
									
		80°	55°	90°	60°	35°	80°	25°	
Medium cutting	HMM  								
		B060	B071	B081	B093	B100	B108		
	P  								
		B060	B072	B081	B094				
	S  								
		B060	B072	B082	B094				
	27  								
	B061	B072	B082	B094		B108			
28  									
	B061	B072		B094	B101				
33  									
	B061	B072	B082	B094	B101	B108			
37  									
	B061	B072	B082	B094		B108			

Chip control range

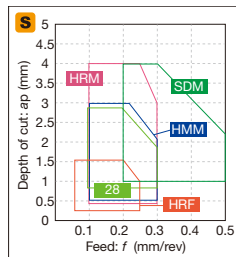
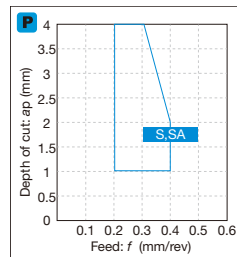
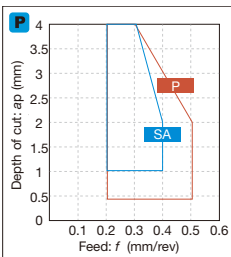

Please see the page B*** for the product details.





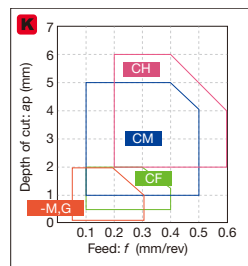
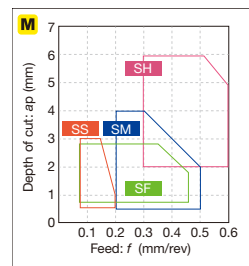
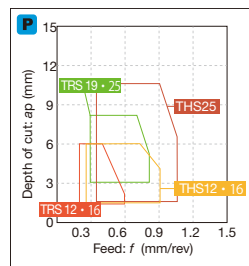
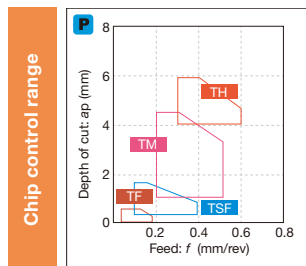









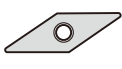

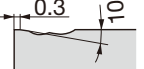

Chipbreaker Overview

Application	Negative type with hole	C	D	S	T	V	W	Y
		80°	55°	90°	60°	35°	80°	25°
Medium cutting	38 	 B061	 B072		 B095			
	Parallel 		 B072					
Medium to heavy cutting	TH 	 B061	 B073	 B082	 B095		 B108	
	THS 	 B062	 B073	 B082	 B095		 B108	
	SH 	 B062	 B073	 B083			 B109	
	CH 	 B062	 B073	 B083	 B095		 B109	
	TRS 	 B062		 B083				

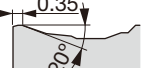

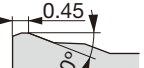
Please see the page B*** for the product details.

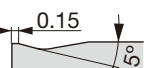
*-M,G: Without chipbreaker

Application	Negative type with hole	C	D	R	S	T	V	W
								
		80°	55°		90°	60°	35°	80°
Medium to heavy cutting (single side)	57  ap (mm) vs f (mm/rev) graph							
		B062	B073		B083	B095		
Heavy cutting (single side)	65  ap (mm) vs f (mm/rev) graph							
		B062			B083			
Heavy cutting (single side)	TU  ap (mm) vs f (mm/rev) graph							
		B063			B084			
Heavy cutting	TUS  ap (mm) vs f (mm/rev) graph							
		B063			B084			
Heavy cutting	61  ap (mm) vs f (mm/rev) graph							
				B076				

Chip control range

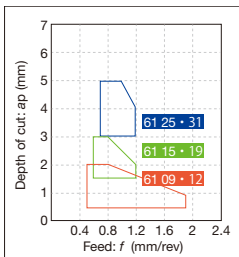
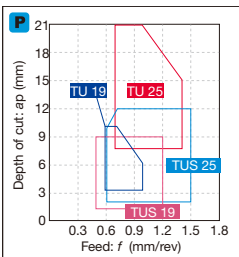















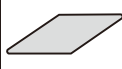
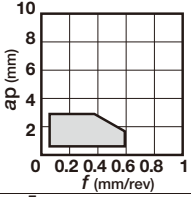

Please see the page B*** for the product details.

Chipbreaker Overview

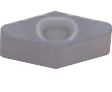
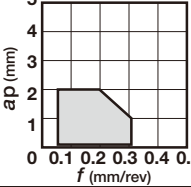
Application		C	D	R	S	T	V	W
Negative type with hole								
		80°	55°		90°	60°	35°	80°
Finishing to medium cutting	M,G-class 							
		B063	B073, B074	B076	B084	B096	B101	B109
Finishing to fine cutting	Wiper M-class 							
		B064						

Application		C	D	KNMX	LNGN	R	S	T
Negative type without hole								
		80°	55°	55°	90°		90°	60°
Finishing	S1 							
				B110				

Please see the page B*** for the product details.

Application		Negative type without hole							
		C	D	H	R	S	T	V	
									
		80°	55°	120°		90°	60°	35°	
Finishing to medium cutting	G-class								
	M,G-class								
		B065	B074	B111		B085		B101	
		B065	B074		B076	B085	B097		

Grade
Insert
Ext. Toolholder
Int. Toolholder
Threading
Grooving
Miniature tool
Milling cutter
Endmill
Drilling tool
Tooling System
User's Guide
Index







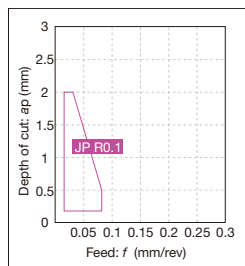
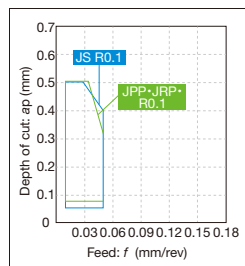
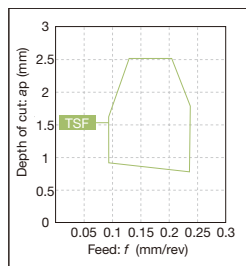
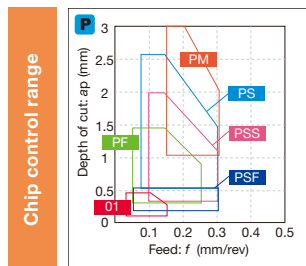









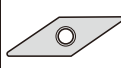
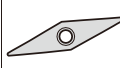
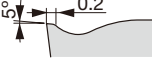
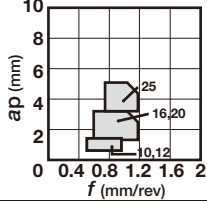

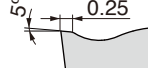
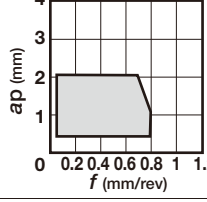

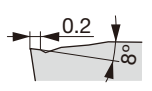
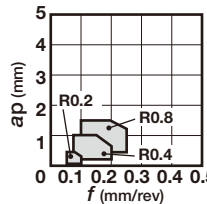
Chipbreaker Overview

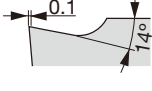
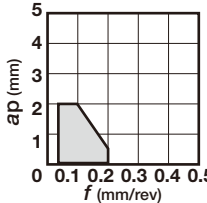
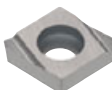
Application	Positive 7° with hole	C	D	R	S	T	V	Y
		80°	55°		90°	60°	35°	25°
Precision finishing (sharp edge)	JP 							
		B112	B121			B138		
Precision finishing (sharp edge)	01 							
		B112	B121			B138		
Finishing (sharp edge)	JS 							
		B112	B121			B138		
Finishing	JS 							
		B112	B121			B138		
	PSF 							
		B113	B121			B138	B152	
Finishing	PF 							
		B113	B122				B152	
Finishing	TSF 							
		B113	B122				B138	B152

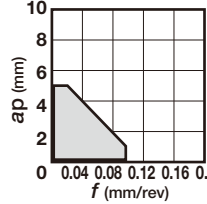

Please see the page B*** for the product details.

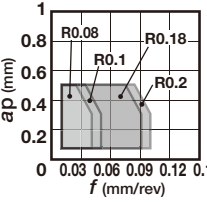
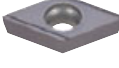
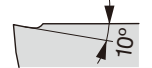
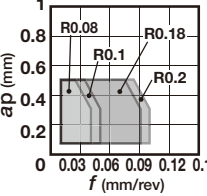
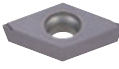

Application	Positive 7° with hole	C	D	R	S	T	V	Y
								
		80°	55°		90°	60°	35°	25°
Finishing	RS  							
	6RS  							
	ZF  							
	W**  							
	J**  							
	JPP  							
JRP  								

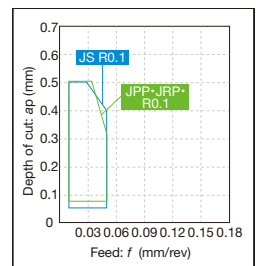
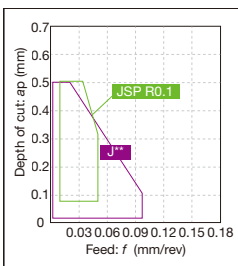
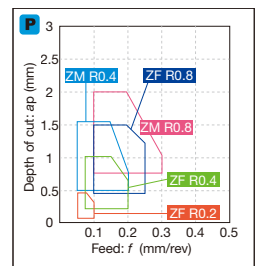
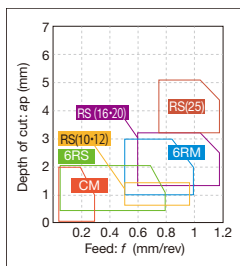
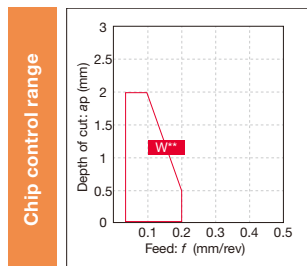







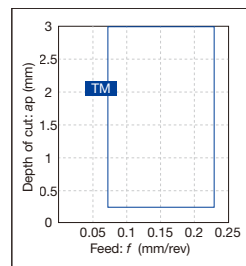
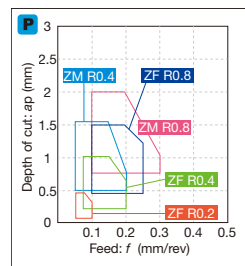
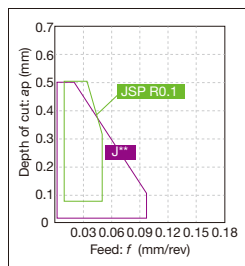
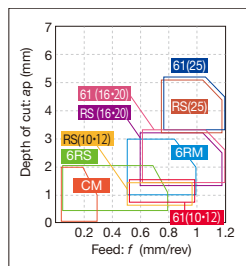
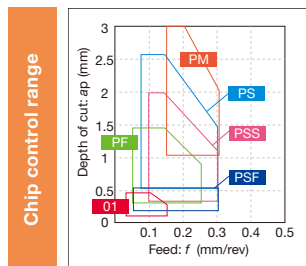







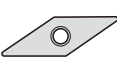
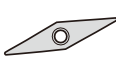
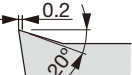





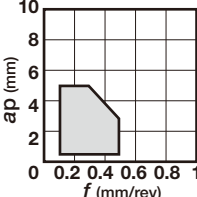
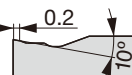

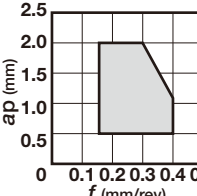

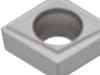
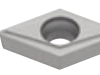

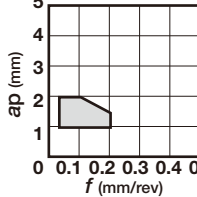

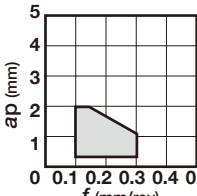
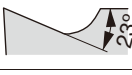
Please see the page B*** for the product details.

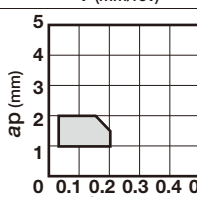
Chipbreaker Overview

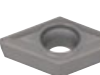
Application		Positive 7° with hole						
		C	D	R	S	T	V	Y
		80°	55°		90°	60°	35°	25°
Finishing (sharp edge)	JSP	 ap (mm) vs f (mm/rev) graph with R0.08, R0.1, R0.18, R0.2						
	PSS	 ap (mm) vs f (mm/rev) graph						
	PS	 ap (mm) vs f (mm/rev) graph						
	TM	 ap (mm) vs f (mm/rev) graph						
	6RM	 ap (mm) vs f (mm/rev) graph						
	ZM	 ap (mm) vs f (mm/rev) graph with R0.4, R0.8						
	CM	 ap (mm) vs f (mm/rev) graph						

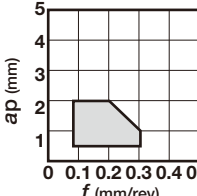

Please see the page B*** for the product details.

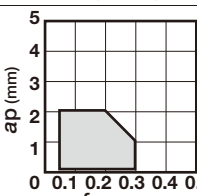
Application	Positive 7° with hole	C	D	R	S	T	V	Y
								
		80°	55°		90°	60°	35°	25°
Finishing to medium cutting (for non-ferrous alloys)	AL 	 B116	 B124	 B130		 B140	 B153	
								
Finishing to medium cutting (wiper)	SW 	 B116						
								
Finishing to medium cutting	All-round 	 B116	 B124				 B153	
								
	SS 					 B140		
								
	Angular 	 B116	 B124					
								
	23 	 B116	 B125		 B134	 B140		
								
M,G-class 	 B116, B117	 B125						
								



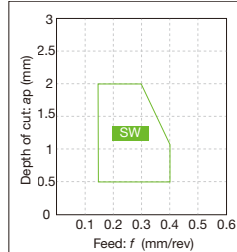
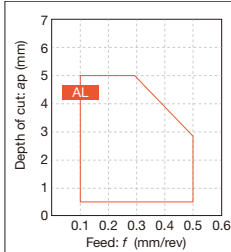
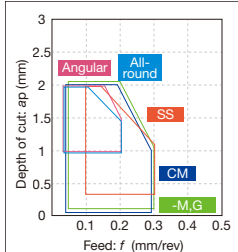
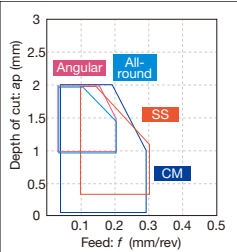







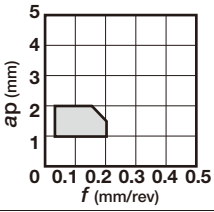

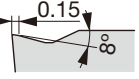
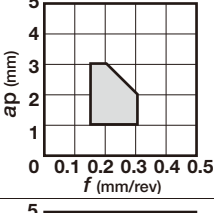

Chip control range

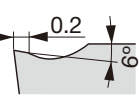
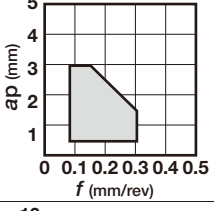

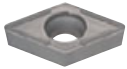
*M,G: Without chipbreaker

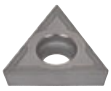

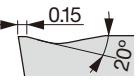
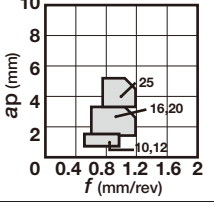



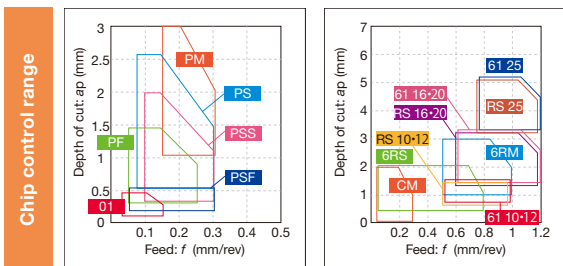







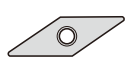
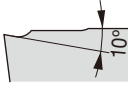
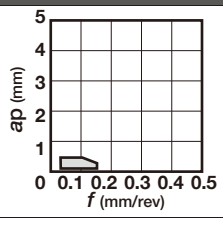

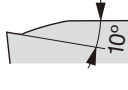
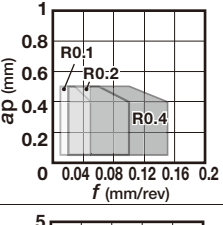

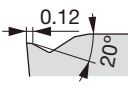
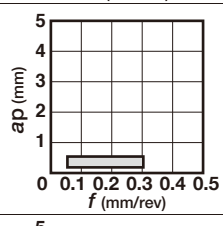
Please see the page B*** for the product details.

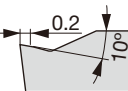
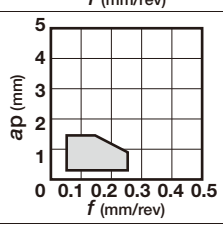
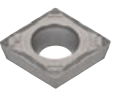
Chipbreaker Overview

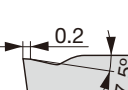
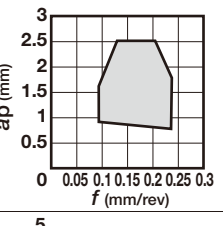
Application	Positive 7° with hole	C	D	R	S	T	V	Y	
		80°	55°		90°	60°	35°	25°	
Finishing to medium cutting	— (with hand)  						 B141		
	PM  	 B117	 B125		 B134	 B141			
	24  	 B117	 B125		 B134	 B141	 B153		
Heavy cutting	61  			 B131					

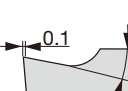
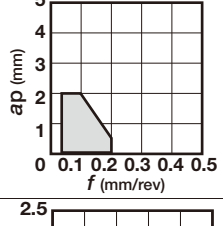
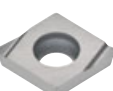

Please see the page B*** for the product details.

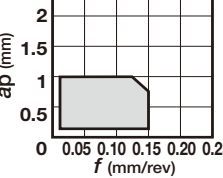
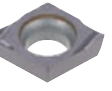
Application	Positive 11° with hole	C	E	S	T	V
						
		80°	75°	90°	60°	35°
Precision finishing	01  				 B142	
	JS  		 B128		 B142	
Finishing	PSF  	 B118			 B142	
	PF  	 B118			 B142	
	TSF  	 B118			 B143	
	W**  	 B118	 B129	 B135	 B143, B144	
	J08  		 B128			

Chip control range

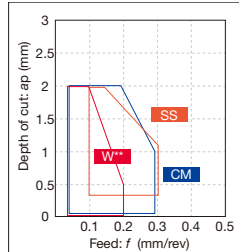
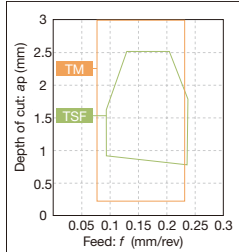
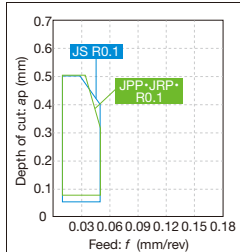
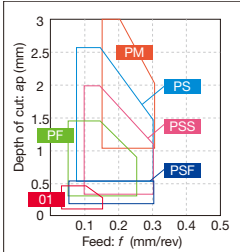







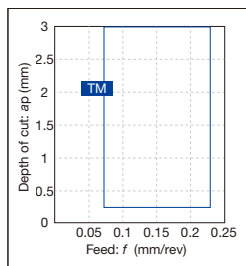
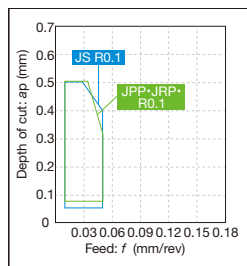
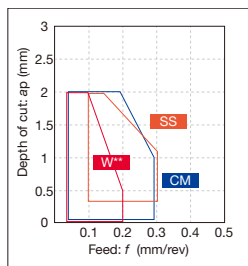
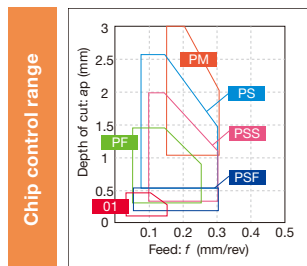





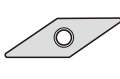
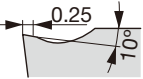
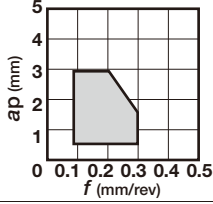
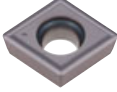

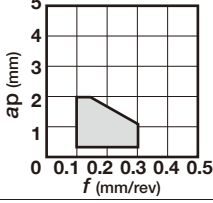

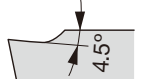
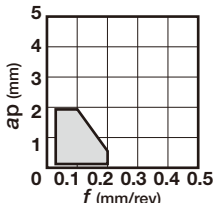

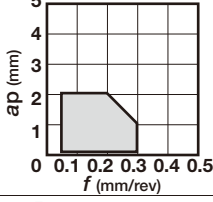
Please see the page B*** for the product details.

Chipbreaker Overview

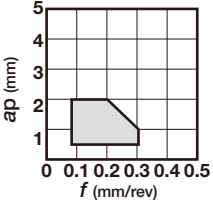
Application	Positive 11° with hole	C	D	S	T	V
		80°	55°	90°	60°	35°
Finishing (sharp edge)	JPP 					 B154
	JRP 					 B154
	JSP 					 B154
Finishing to medium cutting	PSS 	 B118			 B145	
	PS 	 B119	 B126	 B135	 B145	
	TM 	 B119			 B145	
	CM 	 B119		 B135	 B146	

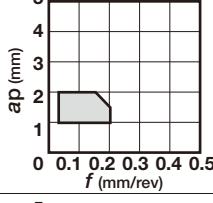

Please see the page B*** for the product details.

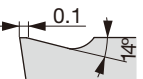
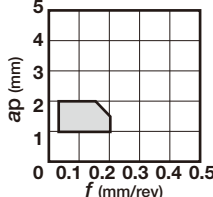
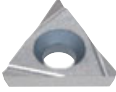
Application		Positive 11° with hole				
		C	S	T	V	
						
		80°	90°	60°	35°	
Finishing to medium cutting	All-round 	 ap (mm) f (mm/rev)				
	SS 	 ap (mm) f (mm/rev)				
	H** 	 ap (mm) f (mm/rev)				
	M,G-class 	 ap (mm) f (mm/rev)				
	23 	 ap (mm) f (mm/rev)				
	(with hand) 	 ap (mm) f (mm/rev)		 (Tungaloy standard hole specification) ISO non-compliant		
	(with hand) 	 ap (mm) f (mm/rev)			 (Tungaloy standard hole specification) ISO non-compliant	



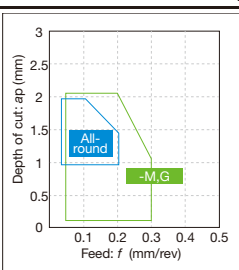



Chip control range





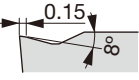
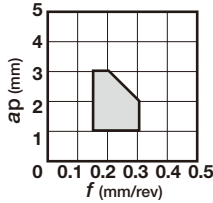

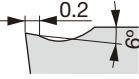
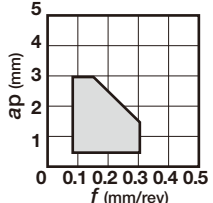
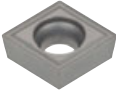
*M,G: Without chipbreaker

Please see the page B*** for the product details.



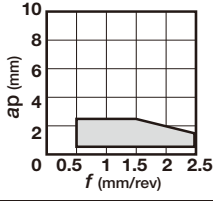



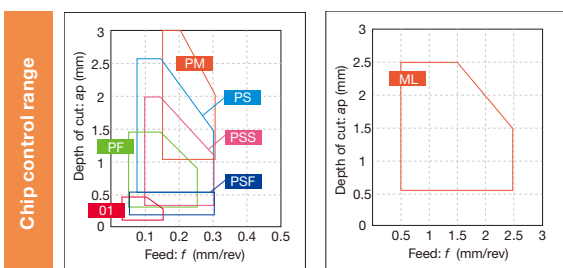







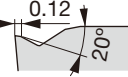

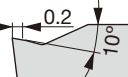

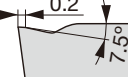



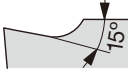

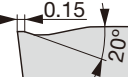
Chipbreaker Overview

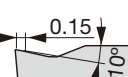
Application		Positive 11° with hole	
		C	T
			
		80°	60°
Medium cutting	PM  		
		B120	B147
Medium cutting	24  		
		B120	B147

Application		W
Positive 11° with hole		
		80°
Heavy cutting	ML  	
		B155

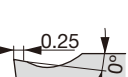

Please see the page B*** for the product details.



Application	Positive 5° with hole	V	W
		35°	80°
Finishing (sharp edge)	JS  ap (mm) vs f (mm/rev) graph with R0.1, R0.4, R0.2, R0.03  B150		
	JS  ap (mm) vs f (mm/rev) graph with R0.1, R0.2, R0.4  B156		
Finishing	PSF  ap (mm) vs f (mm/rev) graph  B150		
	PF  ap (mm) vs f (mm/rev) graph  B150		
	TSF  ap (mm) vs f (mm/rev) graph  B150		
	W08  ap (mm) vs f (mm/rev) graph  B156		
	W11  ap (mm) vs f (mm/rev) graph  B156		
	TM  ap (mm) vs f (mm/rev) graph  B151		
	PSS  ap (mm) vs f (mm/rev) graph  B151		
Finishing to medium cutting	PS  ap (mm) vs f (mm/rev) graph  B151		
	CM  ap (mm) vs f (mm/rev) graph  B151		
	24  ap (mm) vs f (mm/rev) graph  B151		

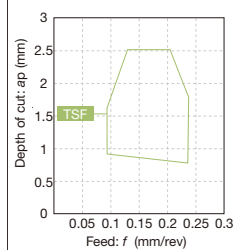
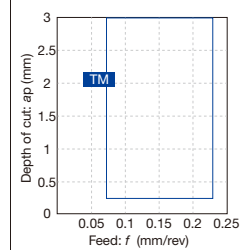
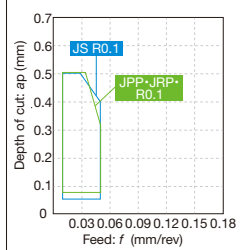
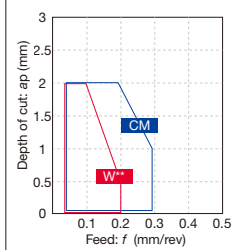
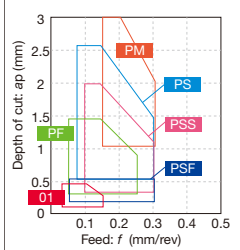

Chip control range



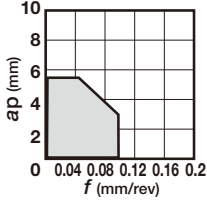

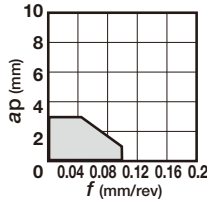

Please see the page B*** for the product details.

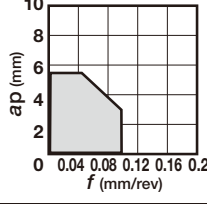

Chipbreaker Overview

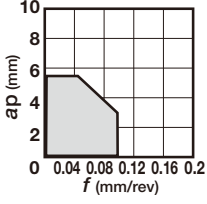

Application	Positive type with hole	JXF 
Front turning		 B159

Application	Positive type with hole	J10E 
Back turning		 B161

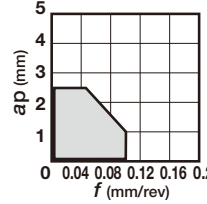



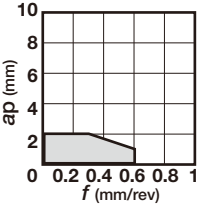







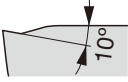
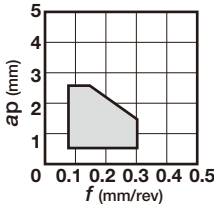

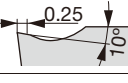
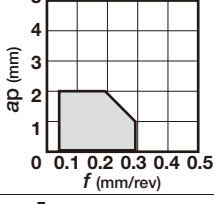



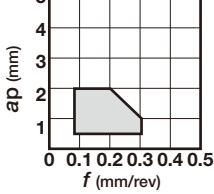

Application	Positive type with hole	JXB 
Back turning		 B160

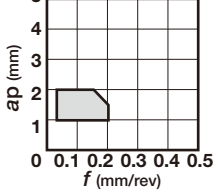
Application	Positive type with hole	JXR 
Reverse turning		 B160

Application	Positive type with hole	JTB 
Back turning		 B161

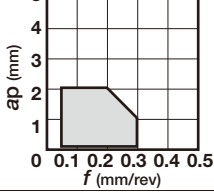
Application	Round	RT 
Medium cutting		Special round insert  B131

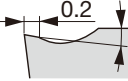
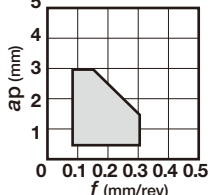
Please see the page B*** for the product details.

Application	Positive 11° without hole	R	S	T
				
			90°	60°
Finishing to medium cutting	PS  			 B148
	CM  		 B137	 B148
	23  		 B137	 B148
	 (with hand) 		 B137	 B148
	 M,G-class 		 B137	 B148, B149
	24  			 B149



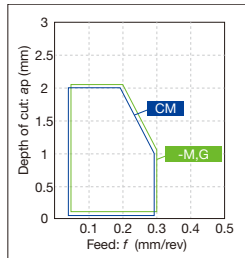
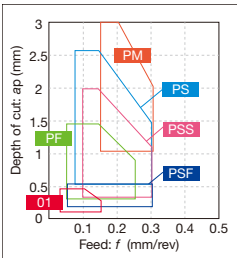







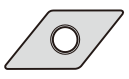
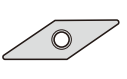

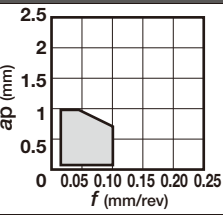
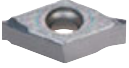

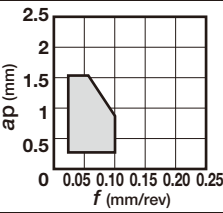



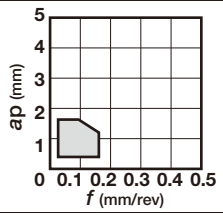

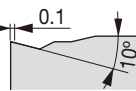
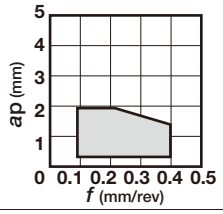
Chip control range

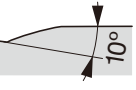
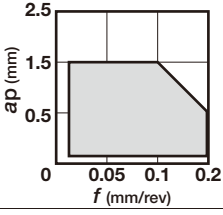

*-M,G: Without chipbreaker

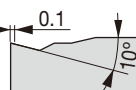
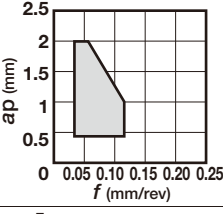
Please see the page B*** for the product details.

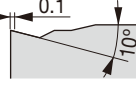
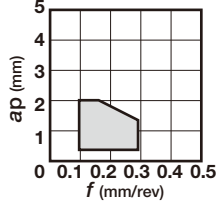
Chipbreaker Overview

Application	Double-sided positive type with hole	D	V	W
				
		55°	35°	80°
Finishing (sharp edge)	JRP  	 B126	 B155	
	JSS  	 B126		 B157
Finishing to medium cutting	SS  	 B126		 B157
Finishing	TSW  			 B157
Finishing to medium cutting (sharp edge)	JS  	 B127	 B155	 B157
	JTS  	 B127		 B158
Finishing to medium cutting	TS  	 B127		 B158

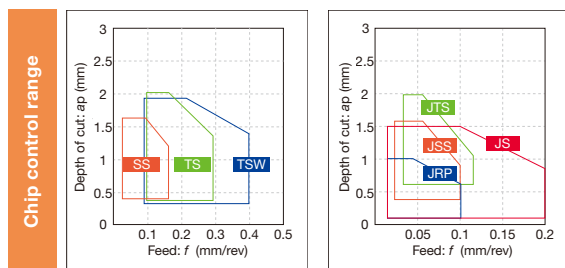

Please see the page B*** for the product details.

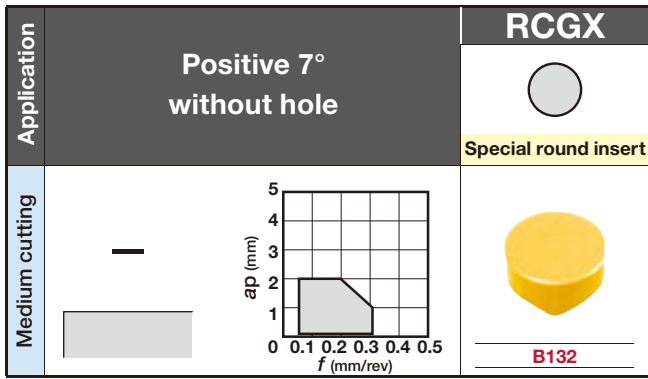

Grade

A

Insert

B

Ext. Toolholder

C

Int. Toolholder

D

Threading

E

Grooving

F

Miniature tool

G

Milling cutter

H

Endmill

I

Drilling tool

J

Tooling System

K

User's Guide

L

Index

M

Insert NEGATIVE TYPE

● : Continuous cutting
 ● : Light interrupted cutting
 ✖ : Heavy interrupted cutting

CN



Rhombic, 80°
with hole

Material	Coated	RE	IC	S	D1
P Steel		●	●	●	●
M Stainless		●	●	●	●
K Cast iron		●	●	●	●
N Non-ferrous		●	●	●	●
S Superalloy		●	●	●	●
H Hard material		●	●	●	●

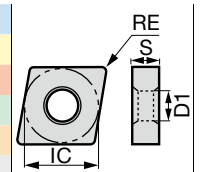

Application	Chipbreaker	Designation	Coated							Dimension (mm)						
			T6215	T5105	T5115	AH8005	AH8015	AH6225	AH6235	AH120	GH330	RE	IC	S	D1	
Finishing	SF	CNMG090304-SF	●					●					0.4	9.525	3.18	3.81
		CNMG090308-SF	●					●					0.8	9.525	3.18	3.81
		CNMG120404-SF	●					●					0.4	12.7	4.76	5.16
		CNMG120408-SF	●					●					0.8	12.7	4.76	5.16
		CNMG120412-SF	●					●					1.2	12.7	4.76	5.16
	SS	CNMG090404E-SS						●	●				0.4	9.525	4.76	3.81
		CNMG090408E-SS						●	●				0.8	9.525	4.76	3.81
		CNMG120404-SS	●					●	●	●	●		0.4	12.7	4.76	5.16
		CNMG120408-SS	●					●	●	●	●		0.8	12.7	4.76	5.16
		CNMG120412-SS	●					●	●	●	●		1.2	12.7	4.76	5.16
	HRF	CNMG120404-HRF				●	●						0.4	12.7	4.76	5.16
		CNMG120408-HRF				●	●						0.8	12.7	4.76	5.16
		CNMG120412-HRF				●	●						1.2	12.7	4.76	5.16
	CF	CNMG120404-CF		●	●								0.4	12.7	4.76	5.16
		CNMG120408-CF		●	●								0.8	12.7	4.76	5.16
CNMG120412-CF			●	●								1.2	12.7	4.76	5.16	

● : Line up

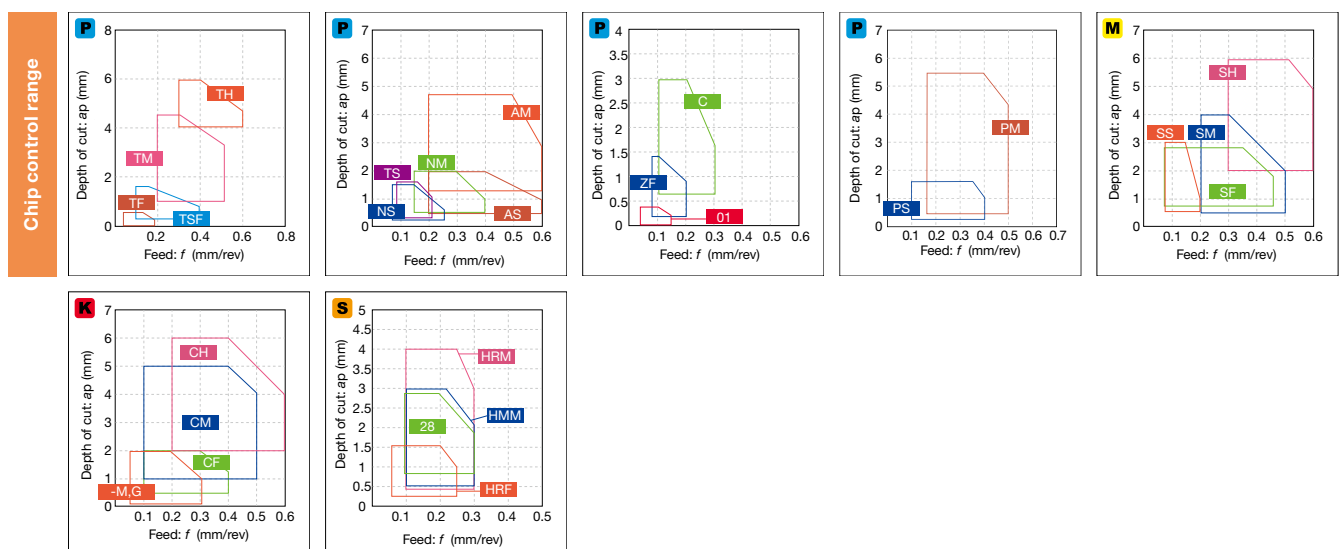

*-M.G: Without chipbreaker

Reference pages: External toolholder → **C015** - Internal toolholder → **D025** -
 J-Series toolholder → **G050** TungCap → **K008** -
 PINZBOHR® → **K178** - Cartridge → **K181** -

Grade
Insert
Ext. Toolholder
Int. Toolholder
Threading
Grooving
Miniature tool
Milling cutter
Endmill
Drilling tool
Tooling System
User's Guide
Index



● : Continuous cutting
● : Light interrupted cutting
* : Heavy interrupted cutting

Insert NEGATIVE TYPE

CN



Rhombic, 80° with hole

P	Steel	●	●	●	●	*	●				●	●	●							
M	Stainless	●	●				●													
K	Cast iron	●	●				●													
N	Non-ferrous																			
S	Superalloy						●													
H	Hard material																			

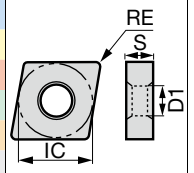

Application	Chipbreaker	Designation	Coated					Coated cermet		Cermet		Uncoated	Dimension (mm)				
			T9205	T9215	T9225	T9235	GH110	GT9530	GT720	NS9530	NS520	TH10	RE	IC	S	D1	
Finishing (wiper)	FW	CNMG090404E-FW	●	●	●			●		●			0.4	9.525	4.76	3.81	
		CNMG090408E-FW	●	●	●			●		●			0.8	9.525	4.76	3.81	
		CNMG120404-FW		●				●		●			0.4	12.7	4.76	5.16	
		CNMG120408-FW	●	●	●			●		●			0.8	12.7	4.76	5.16	
		<i>*Wiper</i>															
Finishing	AFW	CNMG120404-AFW		●	●			●		●			0.4	12.7	4.76	5.16	
		CNMG120408-AFW	●	●	●	●		●					0.8	12.7	4.76	5.16	
	Finishing for mild steel	01	CNGG090302-01								●			0.2	9.525	3.18	3.81
			CNGG090304-01								●			0.4	9.525	3.18	3.81
			CNGG090308-01								●			0.8	9.525	3.18	3.81
			CNGG120402-01								●	●		0.2	12.7	4.76	5.16
		CNGG120404-01								●	●		0.4	12.7	4.76	5.16	
		CNGG120408-01								●	●		0.8	12.7	4.76	5.16	
Boring (double side)	11	CNMG120404-11						●		●			0.4	12.7	4.76	5.16	
		CNMG120408-11						●	●	●			0.8	12.7	4.76	5.16	
Finishing	17	CNMG120404-17								●			0.4	12.7	4.76	5.16	
		CNMG120408-17								●			0.8	12.7	4.76	5.16	
Boring (double side)	CB	CNMG090304-CB								●			0.4	9.525	3.18	3.81	
		CNMG090308-CB								●			0.8	9.525	3.18	3.81	
Finishing	C	CNGG120404R-C				●				●			0.4	12.7	4.76	5.16	
		CNGG120404L-C								●			0.4	12.7	4.76	5.16	
		CNGG120408R-C								●			0.8	12.7	4.76	5.16	
		CNGG120408L-C								●			0.8	12.7	4.76	5.16	

* Please see L011 - L015 about the adjustment of the machining program for rounding or taper machining by using SW/FW. Please contact our sales representatives if you have any question.

● : Line up

- Reference pages: External toolholder → **C015 -** Internal toolholder → **D025 -**
J-Series toolholder → **G050** TungCap → **K008 -**
PINZBOHR® → **K178 -** Cartridge → **K181 -**

Insert NEGATIVE TYPE

- : Continuous cutting
- ◐ : Light interrupted cutting
- * : Heavy interrupted cutting

CN



Rhombic, 80° with hole

Material	P Steel	M Stainless	K Cast iron	N Non-ferrous	S Superalloy	H Hard material	Coated	Coated cermet	Cermet	GT9530	NS9530
●	●	●	●	●	●	●	●	●	●	●	●
◐											
*											

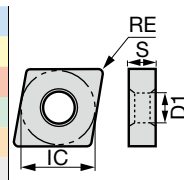

Application	Chipbreaker	Designation	Coated										Coated cermet	Cermet	Dimension (mm)						
			T9205	T9215	T9225	T9235	T6215	T515	AH8015	AH6225	AH6235	AH725	AH110	AH120	GT9530	NS9530	RE	IC	S	D1	
Medium cutting		TM CNMG090304-TM	●	●														0.4	9.525	3.18	3.81
		CNMG090308-TM	●	●	●													0.8	9.525	3.18	3.81
		CNMG090404E-TM	●	●			●	●	●	●			●					0.4	9.525	4.76	3.81
		CNMG090408E-TM	●	●			●	●	●	●			●					0.8	9.525	4.76	3.81
		CNMG090412E-TM	●	●									●					1.2	9.525	4.76	3.81
		CNMG120404-TM	●	●	●	●	●	●	●	●	●			●				0.4	12.7	4.76	5.16
		CNMG120408-TM	●	●	●	●	●	●	●	●	●	●		●				0.8	12.7	4.76	5.16
		CNMG120412-TM	●	●	●	●	●	●	●	●	●		●					1.2	12.7	4.76	5.16
		CNMG120416-TM		●	●	●	●	●	●	●	●			●				1.6	12.7	4.76	5.16
		CNMG160608-TM		●														0.8	15.875	6.35	6.35
		CNMG160612-TM	●	●	●	●								●				1.2	15.875	6.35	6.35
		CNMG190608-TM	●	●	●	●								●				0.8	19.05	6.35	7.93
		CNMG190612-TM	●	●	●	●								●				1.2	19.05	6.35	7.93
		Medium cutting for mild steel		ZM CNMG090408E-ZM	●	●			●	●									0.8	9.525	4.76
CNMG090412E-ZM	●			●					●	●							1.2	9.525	4.76	3.81	
CNMG120404-ZM	●			●			●	●	●	●							0.4	12.7	4.76	5.16	
CNMG120408-ZM	●			●	●	●			●	●		●					0.8	12.7	4.76	5.16	
CNMG120412-ZM	●			●	●	●			●	●		●					1.2	12.7	4.76	5.16	
CNMG120416-ZM	●			●			●	●	●	●							1.6	12.7	4.76	5.16	
													●					0.8	12.7	4.76	5.16
													●					1.2	12.7	4.76	5.16

● : Line up

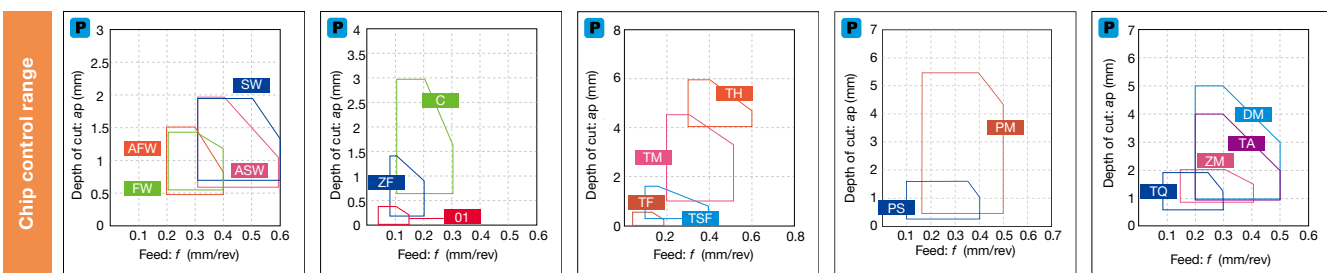

Reference pages: External toolholder → **C015** - Internal toolholder → **D025** -
 J-Series toolholder → **G050** TungCap → **K008** -
 PINZBOHR® → **K178** - Cartridge → **K181** -

Insert NEGATIVE TYPE

● : Continuous cutting
 ● : Light interrupted cutting
 ✱ : Heavy interrupted cutting

CN



**Rhombic, 80°
with hole**

	P Steel	M Stainless	K Cast iron	N Non-ferrous	S Superalloy	H Hard material																														
●																																				
●																																				
●																																				
●																																				
●																																				
●																																				
●																																				
●																																				
●																																				
●																																				
●																																				
●																																				
●																																				
●																																				
●																																				
●																																				
●																																				
●																																				
●																																				
●																																				
●																																				
●																																				

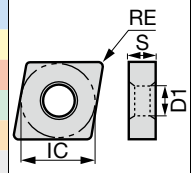

Application	Chipbreaker	Designation	Coated														Dimension (mm)				
			T9205	T9215	T9225	T6215	T505	T515	T5105	T5115	T5125	AH8005	AH8015	AH6225	AH6235	AH905	AH725	RE	IC	S	D1
Medium cutting	SM	CNMG090404E-SM				●												0.4	9.525	4.76	3.81
		CNMG090408E-SM				●												0.8	9.525	4.76	3.81
		CNMG090412E-SM				●												1.2	9.525	4.76	3.81
		CNMG120404-SM				●								●	●	●		0.4	12.7	4.76	5.16
		CNMG120408-SM				●								●	●	●	●	0.8	12.7	4.76	5.16
		CNMG120412-SM				●									●	●	●	1.2	12.7	4.76	5.16
		CNMG160612-SM				●												1.2	15.875	6.35	6.35
		CNMG160616-SM				●												1.6	15.875	6.35	6.35
		CNMG190612-SM				●												1.2	19.05	6.35	7.93
	CNMG190616-SM				●												1.6	19.05	6.35	7.93	
	SDM	CNMG120404-SDM				●							●	●	●	●		0.4	12.7	4.76	5.16
		CNMG120408-SDM				●							●	●	●	●		0.8	12.7	4.76	5.16
		CNMG120412-SDM				●							●	●	●	●		1.2	12.7	4.76	5.16
		HRM	CNMG120404-HRM											●	●			0.4	12.7	4.76	5.16
		CNMG120408-HRM												●	●			0.8	12.7	4.76	5.16
		CNMG120412-HRM												●	●			1.2	12.7	4.76	5.16
HRM	CNMG160608-HRM												●	●			0.8	15.875	6.35	6.35	
	CNMG160612-HRM												●	●			1.2	15.875	6.35	6.35	
	CNMG190612-HRM												●	●			1.2	19.05	6.35	7.93	
	CNMG190616-HRM												●	●			1.6	19.05	6.35	7.93	
	CM	CNMG120404-CM											●	●	●	●		0.4	12.7	4.76	5.16
		CNMG120408-CM											●	●	●	●		0.8	12.7	4.76	5.16
CNMG120412-CM												●	●	●	●		1.2	12.7	4.76	5.16	
CNMG160608-CM													●	●	●		0.8	15.875	6.35	6.35	
CNMG160612-CM													●	●	●		1.2	15.875	6.35	6.35	
Medium cutting (wiper)	SW	CNMG090408E-SW	●	●	●							●					0.8	9.525	4.76	3.81	
		CNMG090412E-SW	●	●	●							●					1.2	9.525	4.76	3.81	
		CNMG120408-SW	●	●	●		●				●						0.8	12.7	4.76	5.16	
		CNMG120412-SW	●	●	●		●				●						1.2	12.7	4.76	5.16	

* Please see L011 - L015 about the adjustment of the machining program for rounding or taper machining by using SW/FW. Please contact our sales representatives if you have any question.

● : Line up

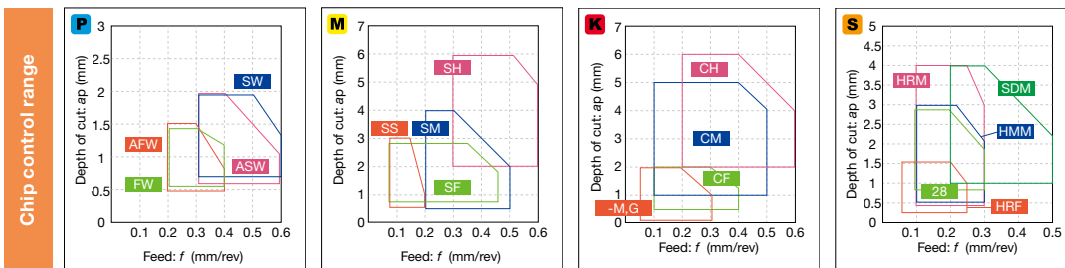

Reference pages: External toolholder → C015 - Internal toolholder → D025 -
 J-Series toolholder → G050 TungCap → K008 -
 PINZBOHR® → K178 - Cartridge → K181 -

Grade
Insert
Toolholder
Ext. Toolholder
Int. Toolholder
Threading
Grooving
Miniature tool
Milling cutter
Endmill
Drilling tool
Tooling System
User's Guide
Index

A
B
C
D
E
F
G
H
I
J
K
L
M

Insert NEGATIVE TYPE

● : Continuous cutting
 ● : Light interrupted cutting
 * : Heavy interrupted cutting

CN



Rhombic, 80°
with hole

	P	M	K	N	S	H
Steel	●	●	●	●	●	●
Stainless	●	●	●	●	●	●
Cast iron	●	●	●	●	●	●
Non-ferrous						
Superalloy						
Hard material						

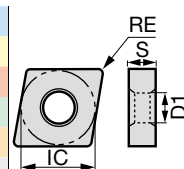

Application	Chipbreaker	Designation	Coated											Coated cermet			Cermet	Uncoated			Dimension (mm)					
			T9205	T9215	T9225	T9235	T6215	AH6225	AH6235	AH905	AH110	AH120	GH330	GH110	GT9530	AT9530	GT720	NS9530	TH10	KS05F	KS20	RE	IC	S	D1	
Medium cutting (wiper)		CNMG120408-ASW	●	●	●													●				0.8	12.7	4.76	5.16	
		CNMG120412-ASW	●	●	●																	1.2	12.7	4.76	5.16	
Medium cutting		CNMG120404-TQ		●	●									●	●			●				0.4	12.7	4.76	5.16	
		CNMG120408-TQ		●	●										●	●			●				0.8	12.7	4.76	5.16
Medium cutting		CNMG120408-TA		●	●																	0.8	12.7	4.76	5.16	
		CNMG120412-TA		●	●																		1.2	12.7	4.76	5.16
Medium cutting		CNMG120404-SA				●	●	●			●											0.4	12.7	4.76	5.16	
		CNMG120408-SA				●	●	●		●	●									●			0.8	12.7	4.76	5.16
		CNMG120412-SA				●	●	●		●	●									●			1.2	12.7	4.76	5.16
		CNMG190612-SA										●								●			1.2	19.05	6.35	7.93
		CNMG190616-SA										●								●			1.6	19.05	6.35	7.93
Medium cutting		CNMG120404-HMM								●																
		CNMG120408-HMM								●										●						
		CNMG120412-HMM								●																
		CNMG160608-HMM								●																
		CNMG160612-HMM								●																
		CNMG160616-HMM								●																
Medium cutting		CNGG120404R-P											●					●		●		0.4	12.7	4.76	5.16	
		CNGG120404L-P											●						●		●		0.4	12.7	4.76	5.16
		CNGG120408R-P											●						●		●		0.8	12.7	4.76	5.16
		CNGG120408L-P											●						●		●		0.8	12.7	4.76	5.16
Medium cutting		CNMG120404R-S		●	●		●	●			●				●			●		●		0.4	12.7	4.76	5.16	
		CNMG120404L-S		●	●		●	●			●				●				●		●		0.4	12.7	4.76	5.16
		CNMG120408R-S		●	●		●	●			●				●				●		●		0.8	12.7	4.76	5.16
		CNMG120408L-S		●	●		●	●			●				●				●		●		0.8	12.7	4.76	5.16

* Please see L011 - L015 about the adjustment of the machining program for rounding or taper machining by using SW/FW.
 Please contact our sales representatives if you have any question.

● : Line up

Reference pages: External toolholder → C015 - Internal toolholder → D025 -
 J-Series toolholder → G050 TungCap → K008 -
 PINZBOHR® → K178 - Cartridge → K181 -

Insert NEGATIVE TYPE

- : Continuous cutting
- ◐ : Light interrupted cutting
- ◑ : Heavy interrupted cutting

CN



Rhombic, 80°
with hole

	P Steel	M Stainless	K Cast iron	N Non-ferrous	S Superalloy	H Hard material	Coated	Coated cermet	Cermet	Uncoated
●	●	●	●	●	●	●	●	●	●	●
◐	◐	◐	◐	◐	◐	◐	◐	◐	◐	◐
◑	◑	◑	◑	◑	◑	◑	◑	◑	◑	◑

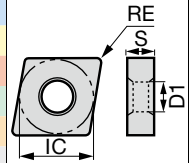

Application	Chipbreaker	Designation	Coated							Coated cermet	Cermet	Uncoated	Dimension (mm)									
			T9205	T9215	T9225	T9235	T515	AH8005	AH8015	AH6225	AH725	AH110	AH120	GH330	GT720	NS9530	KS05F	TH10	RE	IC	S	D1
Medium cutting		27 CNMG120404-27	●	●											●			0.4	12.7	4.76	5.16	
		CNMG120408-27	●	●	●											●			0.8	12.7	4.76	5.16
		CNMG120412-27			●														1.2	12.7	4.76	5.16
		28 CNMG120404-28			●			●	●		●	●					●		0.4	12.7	4.76	5.16
		CNMG120408-28						●	●		●	●					●		0.8	12.7	4.76	5.16
		CNMG120412-28						●	●		●	●					●		1.2	12.7	4.76	5.16
		CNGG120402-28															●		0.2	12.7	4.76	5.16
		CNGG120404-28															●		0.4	12.7	4.76	5.16
		CNGG120408-28															●		0.8	12.7	4.76	5.16
		33 CNMG120408-33									●				●				0.8	12.7	4.76	5.16
		CNMG120416-33			●														1.6	12.7	4.76	5.16
		CNMG160612-33			●														1.2	15.875	6.35	6.35
CNMG190612-33				●														1.2	19.05	6.35	7.93	
		37 CNMG120404-37			●											●			0.4	12.7	4.76	5.16
		CNMG120408-37			●	●										●		●	0.8	12.7	4.76	5.16
	CNMG120412-37			●							●							1.2	12.7	4.76	5.16	
	38 CNMG120404-38																	0.4	12.7	4.76	5.16	
	CNMG120408-38			●					●		●							0.8	12.7	4.76	5.16	
Medium to heavy cutting		TH CNMG120408-TH	●	●	●	●	●	●	●		●							0.8	12.7	4.76	5.16	
		CNMG120412-TH	●	●	●	●	●	●	●	●		●							1.2	12.7	4.76	5.16
		CNMG120416-TH	●	●	●	●	●	●	●	●		●							1.6	12.7	4.76	5.16
		CNMG160612-TH	●	●	●	●	●	●	●	●		●							1.2	15.875	6.35	6.35
		CNMG160616-TH	●	●	●	●	●	●	●	●		●							1.6	15.875	6.35	6.35
		CNMG190612-TH	●	●	●	●	●	●	●	●		●							1.2	19.05	6.35	7.93
		CNMG190616-TH	●	●	●	●	●	●	●	●		●							1.6	19.05	6.35	7.93

● : Line up

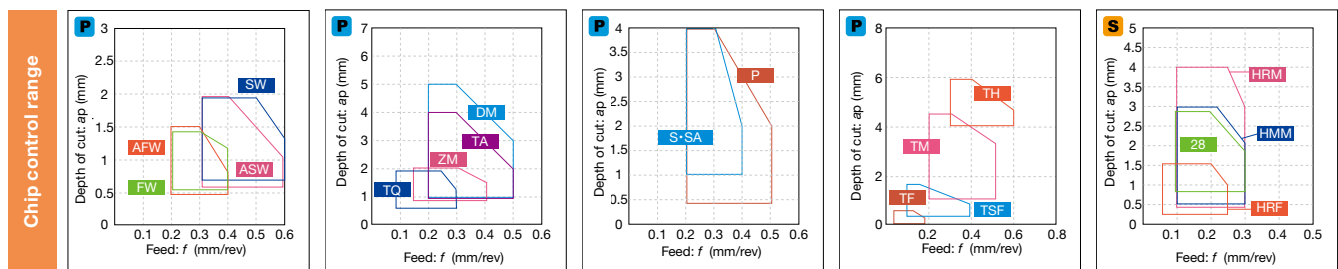

Reference pages: External toolholder → **C015** - Internal toolholder → **D025** -
 J-Series toolholder → **G050** - TungCap → **K008** -
 PINZBOHR® → **K178** - Cartridge → **K181** -



Insert NEGATIVE TYPE

● : Continuous cutting
 ● : Light interrupted cutting
 * : Heavy interrupted cutting

CN



Rhombic, 80° with hole

Material	P Steel	M Stainless	K Cast iron	N Non-ferrous	S Superalloy	H Hard material													
P Steel	●	●	●	●	●	●	●	●	●	●	●	●	●	●	●	●	●	●	●
M Stainless		●	●																
K Cast iron		●	●																
N Non-ferrous				●															
S Superalloy					●														
H Hard material						●													

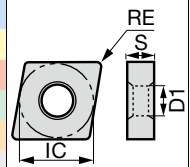

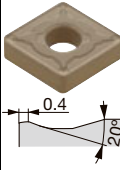
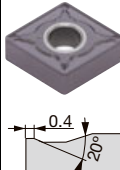
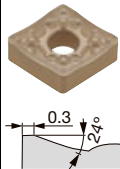
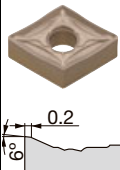
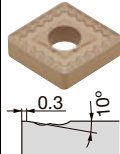
Application	Chipbreaker	Designation	Coated																	Dimension (mm)							
			T9205	T9215	T9225	T9235	T515	T5105	T5115	T5125	AH6225	AH6235											RE	IC	S	D1	
Medium to heavy cutting		THS CNMG120408-THS	●	●	●	●																	0.8	12.7	4.76	5.16	
		CNMG120412-THS	●	●	●	●																		1.2	12.7	4.76	5.16
		CNMG120416-THS	●	●	●	●																		1.6	12.7	4.76	5.16
		CNMG160612-THS	●	●	●	●																		1.2	15.875	6.35	6.35
		CNMG160616-THS	●	●	●	●																		1.6	15.875	6.35	6.35
		CNMG190612-THS		●	●	●																		1.2	19.05	6.35	7.93
		CNMG190616-THS		●	●	●																		1.6	19.05	6.35	7.93
		CNMG190624-THS		●	●	●																		2.4	19.05	6.35	7.93
		CNMG250924-THS		●	●	●																		2.4	25.4	9.52	9.12
Medium to heavy cutting		SH CNMG120408-SH												●	●								0.8	12.7	4.76	5.16	
		CNMG120412-SH												●	●									1.2	12.7	4.76	5.16
		CNMG120416-SH												●	●									1.6	12.7	4.76	5.16
		CNMG160612-SH												●	●									1.2	15.875	6.35	6.35
		CNMG160616-SH												●	●									1.6	15.875	6.35	6.35
		CNMG190612-SH												●	●									1.2	19.05	6.35	7.93
		CNMG190616-SH												●	●									1.6	19.05	6.35	7.93
		CH CNMG120404-CH													●	●	●								0.4	12.7	4.76
CNMG120408-CH													●	●	●								0.8	12.7	4.76	5.16	
CNMG120412-CH													●	●	●								1.2	12.7	4.76	5.16	
CNMG160612-CH													●	●	●								1.2	15.875	6.35	6.35	
CNMG160616-CH													●	●	●								1.6	15.875	6.35	6.35	
CNMG190612-CH													●	●	●								1.2	19.05	6.35	7.93	
CNMG190616-CH													●	●	●								1.6	19.05	6.35	7.93	
Medium to heavy cutting (single side)		TRS CNMM120408-TRS	●	●	●	●																	0.8	12.7	4.76	5.16	
		CNMM120412-TRS		●	●	●																		1.2	12.7	4.76	5.16
		CNMM160612-TRS		●	●	●																		1.2	15.875	6.35	6.35
		CNMM160616-TRS		●	●	●																		1.6	15.875	6.35	6.35
		CNMM190616-TRS		●	●	●																		1.6	19.05	6.35	7.93
		CNMM190624-TRS		●	●	●																		2.4	19.05	6.35	7.93
	CNMM250924-TRS		●	●	●																		2.4	25.4	9.52	9.12	
		57 CNMM120404-57		●																				0.4	12.7	4.76	5.16
		CNMM120408-57		●	●																			0.8	12.7	4.76	5.16
		CNMM120412-57			●																			1.2	12.7	4.76	5.16
		CNMM190612-57			●																			1.2	12.7	4.76	5.16
		CNMM190616-57			●																			1.6	12.7	4.76	5.16
		65 CNMM120412-65		●	●																			1.2	12.7	4.76	5.16
		CNMM160616-65		●																				1.6	15.875	6.35	6.35

● : Line up

Reference pages: External toolholder → **C015** - Internal toolholder → **D025** -
 J-Series toolholder → **G050** TungCap → **K008** -
 PINZBOHR® → **K178** - Cartridge → **K181** -

Insert NEGATIVE TYPE

- : Continuous cutting
- ◐ : Light interrupted cutting
- ◑ : Heavy interrupted cutting

CN



Rhombic, 80°
with hole

	P Steel	M Stainless	K Cast iron	N Non-ferrous	S Superalloy	H Hard material																																		
P	●	●	●	●	●	●	●																																	
M		●	●																																					
K	●	●	●																																					
N				●	●	●	●	●	●	●	●	●	●	●	●	●	●	●	●	●	●	●	●	●	●	●	●	●	●	●	●	●	●	●	●	●	●	●	●	
S					●	●	●	●	●	●	●	●	●	●	●	●	●	●	●	●	●	●	●	●	●	●	●	●	●	●	●	●	●	●	●	●	●	●	●	
H																																								

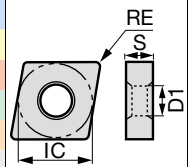

Application	Chipbreaker	Designation	Coated								Cermet	Uncoated	Ceramic	Dimension (mm)			
			T9205	T9215	T9225	T9235	T505	T515	T5105	T5115	T5125	NS520	TH10	FX105	RE	IC	S
Medium to heavy cutting (single side)		TU CNMM190612-TU		●	●	●								1.2	19.05	6.35	7.93
		TU CNMM190616-TU		●	●	●								1.6	19.05	6.35	7.93
		TU CNMM190624-TU	●	●	●									2.4	19.05	6.35	7.93
		TU CNMM250924-TU		●	●									2.4	25.4	9.52	9.12
		TUS CNMM190608-TUS		●	●									0.8	19.05	6.35	7.93
		TUS CNMM190612-TUS		●	●	●								1.2	19.05	6.35	7.93
		TUS CNMM190616-TUS		●	●	●								1.6	19.05	6.35	7.93
		TUS CNMM190624-TUS		●	●	●								2.4	19.05	6.35	7.93
		TUS CNMM190632-TUS		●	●									3.2	19.05	6.35	7.93
		TUS CNMM250916-TUS		●	●	●								1.6	25.4	9.52	9.12
		TUS CNMM250924-TUS		●	●	●								2.4	25.4	9.52	9.12
		TUS CNMM250932-TUS		●	●									3.2	25.4	9.52	9.12
Finishing to medium cutting		CNMA090404E												0.4	9.525	4.76	3.81
		CNMA090408E												0.8	9.525	4.76	3.81
		CNMA090412E												1.2	9.525	4.76	3.81
		CNMA090416E												1.6	9.525	4.76	3.81
		CNMA120404											●	0.4	12.7	4.76	5.16
		CNMA120408	●				●	●	●	●	●	●	●	0.8	12.7	4.76	5.16
		CNMA120412	●				●	●	●	●	●	●	●	1.2	12.7	4.76	5.16
		CNMA120416	●					●	●	●	●	●	●	1.6	12.7	4.76	5.16
		CNMA160608												0.8	15.875	6.35	6.35
		CNMA160612												1.2	15.875	6.35	6.35
		CNMA160616												1.6	15.875	6.35	6.35
		CNMA190612												1.2	19.05	6.35	7.93
		CNMA190616												1.6	19.05	6.35	7.93

● : Line up

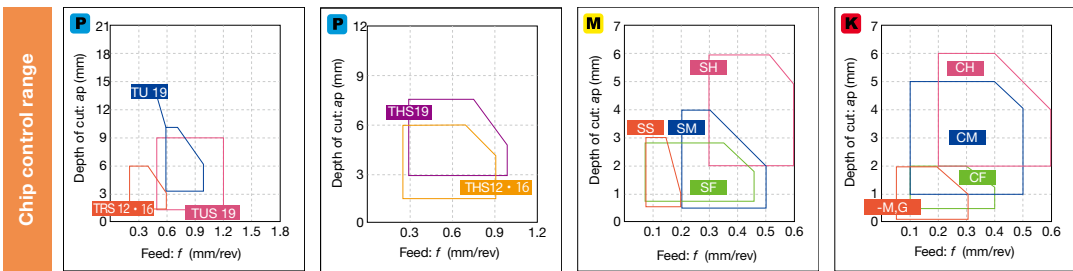

*-M,G: Without chipbreaker

- Reference pages: External toolholder → C015 - Internal toolholder → D025 -
 J-Series toolholder → G050 TungCap → K008 -
 PINZBOHR® → K178 - Cartridge → K181 -

Grade
Insert
Ext. Toolholder
Int. Toolholder
Threading
Grooving
Miniature tool
Milling cutter
Endmill
Drilling tool
Tooling System
User's Guide
Index

A
B
C
D
E
F
G
H
I
J
K
L
M

● : Continuous cutting
 ● : Light interrupted cutting
 ✱ : Heavy interrupted cutting

Insert NEGATIVE TYPE

CN



Rhombic, 80°
with hole

P	Steel	●●
M	Stainless	●
K	Cast iron	●●
N	Non-ferrous	●●●●
S	Superalloy	●●●●
H	Hard material	●●●●

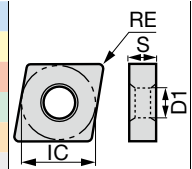

Application	Chipbreaker	Designation	Cermet		Ceramic						Dimension (mm)				
			NS520		TZ120	FX105	CX710	LX10	LX11	LX21	RE	IC	S	D1	
Wiper		CNMA120408W			●							0.8	12.7	4.76	5.16
		CNMA120412W			●							1.2	12.7	4.76	5.16
		CNMA120416W			●							1.6	12.7	4.76	5.16
Finishing to medium cutting		CNGA120404			●	●	▲	●				0.4	12.7	4.76	5.16
		CNGA120408	●		●	●	●	●	▲	●		0.8	12.7	4.76	5.16
		CNGA120412			●	●	●	▲	●			1.2	12.7	4.76	5.16
		CNGA120416			●	●	●	▲	●			1.6	12.7	4.76	5.16
		CNGA120420				●	●	▲	●			2	12.7	4.76	5.16

● : Line up
 ▲ : To be discontinued

Chip control range

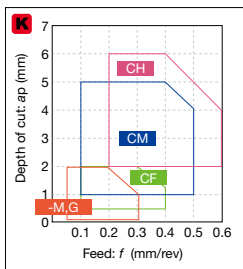

*-M,G: Without chipbreaker

Reference pages: External toolholder → **C015 -** Internal toolholder → **D025 -**
 J-Series toolholder → **G050** TungCap → **K008 -**
 PINZBOHR® → **K178 -** Cartridge → **K181 -**

DN

Rhombic, 55° with hole

	P	M	K	N	S	H	Steel	Stainless	Cast iron	Non-ferrous	Superalloy	Hard material	Other	Other	Other	Other	Other	Other	Other	Other	
●	●	●	●	●	●	●	●	●	●	●	●	●	●	●	●	●	●	●	●	●	●
◐	◐	◐	◐	◐	◐	◐	◐	◐	◐	◐	◐	◐	◐	◐	◐	◐	◐	◐	◐	◐	◐
✳	✳	✳	✳	✳	✳	✳	✳	✳	✳	✳	✳	✳	✳	✳	✳	✳	✳	✳	✳	✳	✳

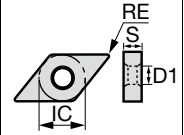

Application	Chipbreaker	Designation	Coated							Coated cermet		Cermet		Uncoated	Dimension (mm)								
			T9205	T9215	T9225	T9235	T6215	AH8005	AH8015	AH6225	AH6235	AH120	GH330	GT9530	AT9530	NS9530	NS520	KS20	RE	IC	S	D1	
Finishing		TS DNMG110402E-TS	●	●	●	●	●	●	●	●	●	●	●	●	●	●	●	●	●	●	●	●	
		DNMG110404E-TS	●	●	●	●	●	●	●	●	●	●	●	●	●	●	●	●	●	●	●	●	●
		DNMG110408E-TS	●	●	●	●	●	●	●	●	●	●	●	●	●	●	●	●	●	●	●	●	●
		DNMG150404-TS	●	●	●	●	●	●	●	●	●	●	●	●	●	●	●	●	●	●	●	●	●
		DNMG150408-TS	●	●	●	●	●	●	●	●	●	●	●	●	●	●	●	●	●	●	●	●	●
		DNMG150412-TS	●	●	●	●	●	●	●	●	●	●	●	●	●	●	●	●	●	●	●	●	●
		DNMG150604-TS	●	●	●	●	●	●	●	●	●	●	●	●	●	●	●	●	●	●	●	●	●
		DNMG150608-TS	●	●	●	●	●	●	●	●	●	●	●	●	●	●	●	●	●	●	●	●	●
	DNMG150612-TS	●	●	●	●	●	●	●	●	●	●	●	●	●	●	●	●	●	●	●	●	●	
		SF DNMG150404-SF	●	●	●	●	●	●	●	●	●	●	●	●	●	●	●	●	●	●	●	●	
		DNMG150408-SF	●	●	●	●	●	●	●	●	●	●	●	●	●	●	●	●	●	●	●	●	●
		DNMG150604-SF	●	●	●	●	●	●	●	●	●	●	●	●	●	●	●	●	●	●	●	●	●
		DNMG150608-SF	●	●	●	●	●	●	●	●	●	●	●	●	●	●	●	●	●	●	●	●	●
		SS DNMG110404E-SS	●	●	●	●	●	●	●	●	●	●	●	●	●	●	●	●	●	●	●	●	
		DNMG110408E-SS	●	●	●	●	●	●	●	●	●	●	●	●	●	●	●	●	●	●	●	●	●
		DNMG150404-SS	●	●	●	●	●	●	●	●	●	●	●	●	●	●	●	●	●	●	●	●	●
DNMG150408-SS		●	●	●	●	●	●	●	●	●	●	●	●	●	●	●	●	●	●	●	●	●	
DNMG150412-SS		●	●	●	●	●	●	●	●	●	●	●	●	●	●	●	●	●	●	●	●	●	
DNMG150604-SS		●	●	●	●	●	●	●	●	●	●	●	●	●	●	●	●	●	●	●	●	●	
DNMG150608-SS		●	●	●	●	●	●	●	●	●	●	●	●	●	●	●	●	●	●	●	●	●	
DNMG150612-SS		●	●	●	●	●	●	●	●	●	●	●	●	●	●	●	●	●	●	●	●	●	
	HRF DNMG150404-HRF	●	●	●	●	●	●	●	●	●	●	●	●	●	●	●	●	●	●	●	●		
	DNMG150408-HRF	●	●	●	●	●	●	●	●	●	●	●	●	●	●	●	●	●	●	●	●	●	
	DNMG150604-HRF	●	●	●	●	●	●	●	●	●	●	●	●	●	●	●	●	●	●	●	●	●	
	DNMG150608-HRF	●	●	●	●	●	●	●	●	●	●	●	●	●	●	●	●	●	●	●	●	●	

● : Line up

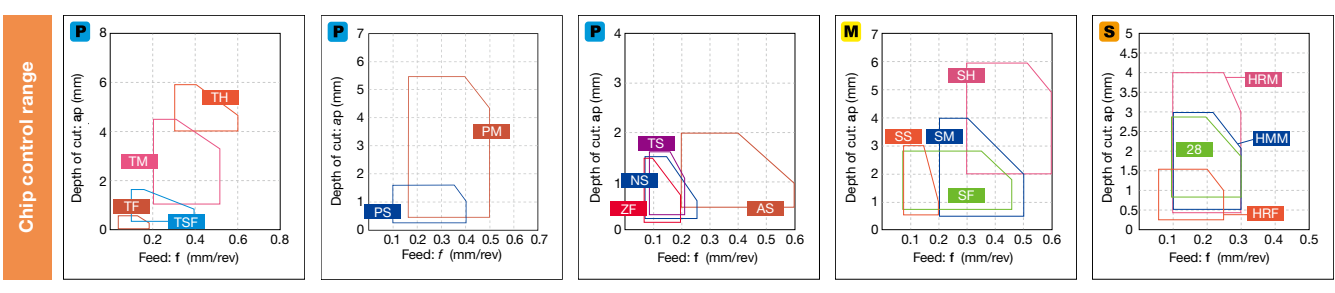

Reference pages: External toolholder → **C034 -** Internal toolholder → **D069 -**
 J-Series toolholder → **G068** TungCap → **C034 -, K012 -**

Grade: A
 Insert: B
 Ext. Toolholder: C
 Int. Toolholder: D
 Threading: E
 Grooving: F
 Miniature tool: G
 Milling cutter: H
 Endmill: I
 Drilling tool: J
 Tooling System: K
 User's Guide: L
 Index: M

Insert NEGATIVE TYPE

● : Continuous cutting
 ● : Light interrupted cutting
 * : Heavy interrupted cutting

DN

P Steel	●●			●●	●		●●●●	●●●●			●			
M Stainless	●●			●●	●		●●●●	●●●●			●			
K Cast iron	●●	●	●	●●	●		●●●●	●●●●			●			
N Non-ferrous											●			
S Superalloy						●								
H Hard material														

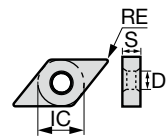

Application	Chipbreaker	Designation	Coated					Coated cermet		Cermet		Uncoated	Dimension (mm)			
			T9215	T5105	T5115	GH330	GH110	GT9530	GT720	NS9530	NS520	TH10	RE	IC	S	D1
			●	●	●	●	●	●	●	●	●	●	●	●	●	●
Finishing		CF DNMG150404-CF	●	●								0.4	12.7	4.76	5.16	
		DNMG150408-CF	●	●								0.8	12.7	4.76	5.16	
		DNMG150412-CF	●	●								1.2	12.7	4.76	5.16	
		DNMG150604-CF	●	●								0.4	12.7	6.35	5.16	
		DNMG150608-CF	●	●								0.8	12.7	6.35	5.16	
		DNMG150612-CF	●	●								1.2	12.7	6.35	5.16	
Finishing (wiper)		FW DNMG110404E-FW	●									0.4	9.525	4.76	3.81	
		DNMG110408E-FW	●									0.8	9.525	4.76	3.81	
		DNMG150404-FW	●									0.4	12.7	4.76	5.16	
		DNMG150408-FW	●									0.8	12.7	4.76	5.16	
		DNMG150604-FW	●									0.4	12.7	6.35	5.16	
		DNMG150608-FW	●									0.8	12.7	6.35	5.16	
Finishing		01 DNGG110402-01							●			0.2	9.525	4.76	3.81	
		DNMG110404-01							●	●		0.4	9.525	4.76	3.81	
		DNMG110408-01							●	●		0.8	9.525	4.76	3.81	
		DNMG150402-01								●	●	●	0.2	12.7	4.76	5.16
		DNMG150404-01					●			●	●	●	0.4	12.7	4.76	5.16
		DNMG150408-01					●			●	●	●	0.8	12.7	4.76	5.16
Finishing		11 DNMG110404-11							●			0.4	9.525	4.76	3.81	
		DNMG110408-11							●			0.8	9.525	4.76	3.81	
		DNMG150404-11				●				●	●	0.4	12.7	4.76	5.16	
		DNMG150408-11	●							●	●	0.8	12.7	4.76	5.16	
Finishing for mild steel		17 DNMG150404-17								●		0.4	12.7	4.76	5.16	
		DNMG150408-17								●		0.8	12.7	4.76	5.16	
Boring (double side)		CB DNMG110404-CB						●	●			0.4	9.525	4.76	3.81	
		DNMG110408-CB	●						●	●		0.8	9.525	4.76	3.81	

* Please see **L011 - L015** about the adjustment of the machining program for rounding or taper machining by using SW/FW.
 ● : Line up
 Please contact our sales representatives if you have any question.

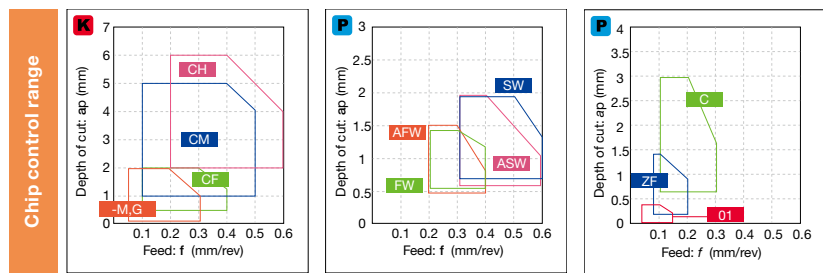

*-M,G: Without chipbreaker

Reference pages: External toolholder → **C034 -** Internal toolholder → **D069 -**
 J-Series toolholder → **G068** TungCap → **C034 -, K012 -**

Insert NEGATIVE TYPE

- : Continuous cutting
- ◐ : Light interrupted cutting
- ◑ : Heavy interrupted cutting

DN

 Rhombic, 55° with hole

Material	Coated	Coated cermet	Cermet	Dimension (mm)																																																																				
P Steel	● ● ● ● ◐ ◑		● ●	<table border="1"> <thead> <tr> <th>RE</th> <th>IC</th> <th>S</th> <th>D1</th> </tr> </thead> <tbody> <tr><td>0.4</td><td>9.525</td><td>4.76</td><td>3.81</td></tr> <tr><td>0.8</td><td>9.525</td><td>4.76</td><td>3.81</td></tr> <tr><td>1.2</td><td>9.525</td><td>4.76</td><td>3.81</td></tr> <tr><td>0.4</td><td>9.525</td><td>4.76</td><td>3.81</td></tr> <tr><td>0.8</td><td>9.525</td><td>4.76</td><td>3.81</td></tr> <tr><td>0.4</td><td>12.7</td><td>4.76</td><td>5.16</td></tr> <tr><td>0.8</td><td>12.7</td><td>4.76</td><td>5.16</td></tr> <tr><td>1.2</td><td>12.7</td><td>4.76</td><td>5.16</td></tr> <tr><td>0.4</td><td>12.7</td><td>6.35</td><td>5.16</td></tr> <tr><td>0.8</td><td>12.7</td><td>6.35</td><td>5.16</td></tr> <tr><td>1.2</td><td>12.7</td><td>6.35</td><td>5.16</td></tr> <tr><td>1.6</td><td>12.7</td><td>6.35</td><td>5.16</td></tr> <tr><td>0.4</td><td>12.7</td><td>6.35</td><td>5.16</td></tr> <tr><td>0.8</td><td>12.7</td><td>6.35</td><td>5.16</td></tr> <tr><td>1.2</td><td>12.7</td><td>6.35</td><td>5.16</td></tr> <tr><td>1.6</td><td>12.7</td><td>6.35</td><td>5.16</td></tr> </tbody> </table>	RE	IC	S	D1	0.4	9.525	4.76	3.81	0.8	9.525	4.76	3.81	1.2	9.525	4.76	3.81	0.4	9.525	4.76	3.81	0.8	9.525	4.76	3.81	0.4	12.7	4.76	5.16	0.8	12.7	4.76	5.16	1.2	12.7	4.76	5.16	0.4	12.7	6.35	5.16	0.8	12.7	6.35	5.16	1.2	12.7	6.35	5.16	1.6	12.7	6.35	5.16	0.4	12.7	6.35	5.16	0.8	12.7	6.35	5.16	1.2	12.7	6.35	5.16	1.6	12.7	6.35	5.16
RE	IC	S	D1																																																																					
0.4	9.525	4.76	3.81																																																																					
0.8	9.525	4.76	3.81																																																																					
1.2	9.525	4.76	3.81																																																																					
0.4	9.525	4.76	3.81																																																																					
0.8	9.525	4.76	3.81																																																																					
0.4	12.7	4.76	5.16																																																																					
0.8	12.7	4.76	5.16																																																																					
1.2	12.7	4.76	5.16																																																																					
0.4	12.7	6.35	5.16																																																																					
0.8	12.7	6.35	5.16																																																																					
1.2	12.7	6.35	5.16																																																																					
1.6	12.7	6.35	5.16																																																																					
0.4	12.7	6.35	5.16																																																																					
0.8	12.7	6.35	5.16																																																																					
1.2	12.7	6.35	5.16																																																																					
1.6	12.7	6.35	5.16																																																																					
M Stainless	● ●																																																																							
K Cast iron	● ●		● ●																																																																					
N Non-ferrous			● ●																																																																					
S Superalloy			● ●																																																																					
H Hard material																																																																								

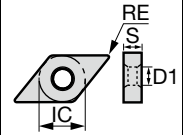

Application	Chipbreaker	Designation	Coated											Coated cermet		Cermet		Dimension (mm)				
			T9205	T9215	T9225	T9235	T6215	T515	AH8005	AH8015	AH6225	AH6235	AH110	AH120	GT9530	NS9530	RE	IC	S	D1		
Medium cutting	TM	DNMG110404E-TM	●	●	●	◐	◑					●	●					0.4	9.525	4.76	3.81	
		DNMG110408E-TM	●	●						●	●		●						0.8	9.525	4.76	3.81
		DNMG110412E-TM	●	●						●	●		●						1.2	9.525	4.76	3.81
		DNMG110404-TM	●	●	●														0.4	9.525	4.76	3.81
		DNMG110408-TM	●	●	●														0.8	9.525	4.76	3.81
		DNMG150404-TM	●	●	●	●	●						●						0.4	12.7	4.76	5.16
		DNMG150408-TM	●	●	●	●	●						●						0.8	12.7	4.76	5.16
		DNMG150412-TM	●	●	●	●	●						●						1.2	12.7	4.76	5.16
		DNMG150416-TM		●	●	●	●						●						1.6	12.7	4.76	5.16
		DNMG150604-TM	●	●	●	●							●						0.4	12.7	6.35	5.16
		DNMG150608-TM	●	●	●	●							●						0.8	12.7	6.35	5.16
		DNMG150612-TM	●	●	●	●							●						1.2	12.7	6.35	5.16
	DNMG150616-TM	●	●	●	●							●						1.6	12.7	6.35	5.16	
	PM	DNMG110404E-PM	●	●	●							●	●					0.4	9.525	4.76	3.81	
		DNMG110408E-PM	●	●								●	●					0.8	9.525	4.76	3.81	
		DNMG110412E-PM	●	●								●	●					1.2	9.525	4.76	3.81	
		DNMG150404-PM	●	●	●							●	●					0.4	12.7	4.76	5.16	
		DNMG150408-PM	●	●	●							●	●					0.8	12.7	4.76	5.16	
		DNMG150412-PM	●	●	●							●	●					1.2	12.7	4.76	5.16	
		DNMG150416-PM	●	●	●							●	●					1.6	12.7	4.76	5.16	
		DNMG150604-PM	●	●	●							●	●					0.4	12.7	6.35	5.16	
		DNMG150608-PM	●	●	●							●	●					0.8	12.7	6.35	5.16	
		DNMG150612-PM	●	●	●							●	●					1.2	12.7	6.35	5.16	
		DNMG150616-PM	●	●	●							●	●					1.6	12.7	6.35	5.16	
Medium cutting for mild steel		ZM	DNMG110408E-ZM	●	●	●						●	●					0.8	9.525	4.76	3.81	
	DNMG110412E-ZM		●	●								●	●					1.2	9.525	4.76	3.81	
	DNMG150404-ZM		●	●	●							●	●					0.4	12.7	4.76	5.16	
	DNMG150408-ZM		●	●	●							●	●		●	●		0.8	12.7	4.76	5.16	
	DNMG150412-ZM		●	●	●							●	●		●	●		1.2	12.7	4.76	5.16	
	DNMG150416-ZM		●	●	●							●	●		●	●		1.6	12.7	4.76	5.16	
	DNMG150604-ZM		●	●	●							●	●					0.4	12.7	6.35	5.16	
	DNMG150608-ZM		●	●	●							●	●					0.8	12.7	6.35	5.16	
	DNMG150612-ZM		●	●	●							●	●					1.2	12.7	6.35	5.16	
	DNMG150616-ZM		●	●	●							●	●					1.6	12.7	6.35	5.16	
	Medium cutting		AM	DNMG150408-AM	●	●													0.8	12.7	4.76	5.16
				DNMG150412-AM	●	●													1.2	12.7	4.76	5.16
DNMG150416-AM		●		●													1.6	12.7	4.76	5.16		
DNMG150608-AM		●		●													0.8	12.7	6.35	5.16		
DNMG150612-AM		●		●													1.2	12.7	6.35	5.16		
DNMG150616-AM		●		●													1.6	12.7	6.35	5.16		

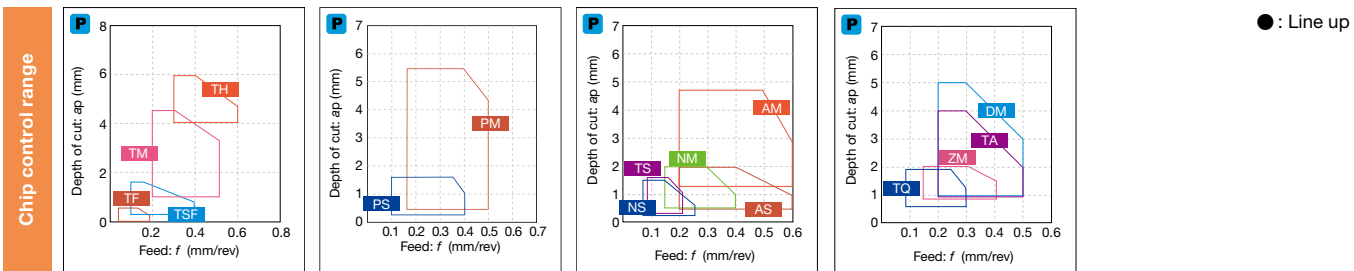

Reference pages: External toolholder → **C034** - Internal toolholder → **D069** -
 J-Series toolholder → **G068** TungCap → **C034** -, **K012** -

Grade
Insert
Toolholder
Ext. Toolholder
Int. Toolholder
Threading
Grooving
Miniature tool
Milling cutter
Endmill
Drilling tool
Tooling System
User's Guide
Index

Insert NEGATIVE TYPE

● : Continuous cutting
 ● : Light interrupted cutting
 ✱ : Heavy interrupted cutting

DN

Rhombic, 55° with hole

	P	M	K	N	S	H
Steel	●	●	●	●	●	●
Stainless	●	●				
Cast iron	●	●	●			
Non-ferrous				●	●	●
Superalloy						
Hard material						

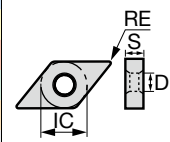

Application	Chipbreaker	Designation	Coated												Coated cermet	Cermet		Un-coated	Dimension (mm)									
			T9205	T9215	T9225	T9235	T6215	T505	T515	T5105	T5115	T5125	AH8005	AH8015	AH6225	AH6235	AH110	AH120	GT9530	NS9530	NS520	TH10	RE	IC	S	D1		
Medium cutting		NM DNMG150408-NM	●	●	●	●													●	●			0.8	12.7	4.76	5.16		
		DNMG150412-NM	●	●	●	●														●				1.2	12.7	4.76	5.16	
		DNMG150608-NM																		●	●			0.8	12.7	6.35	5.16	
		DM DNMG150404-DM		●	●		●						●	●										0.4	12.7	4.76	5.16	
		DNMG150408-DM		●	●	●	●							●	●										0.8	12.7	4.76	5.16
		DNMG150412-DM	●	●	●	●	●							●	●										1.2	12.7	4.76	5.16
		DNMG150416-DM		●	●		●							●	●										1.6	12.7	4.76	5.16
		DNMG150604-DM		●	●		●							●	●										0.4	12.7	6.35	5.16
		DNMG150608-DM		●	●	●	●							●	●										0.8	12.7	6.35	5.16
		DNMG150612-DM		●	●	●	●							●	●										1.2	12.7	6.35	5.16
		DNMG150616-DM		●	●		●								●	●									1.6	12.7	6.35	5.16
	Finishing to medium cutting		All-round DNMG110404		●	●					●	●	●							●	●			0.4	9.525	4.76	3.81	
			DNMG110408		●	●	●	●				●	●	●							●	●			0.8	9.525	4.76	3.81
			DNMG150404		●	●	●					●	●	●					●	●		●	●	●	0.4	12.7	4.76	5.16
DNMG150408				●	●	●					●	●	●					●	●		●	●	●	0.8	12.7	4.76	5.16	
DNMG150412				●	●	●	●				●	●	●					●	●		●	●	●	1.2	12.7	4.76	5.16	
DNMG150416				●	●						●	●	●												1.6	12.7	4.76	5.16
DNMG150604				●	●						●	●	●												0.4	12.7	6.35	5.16
DNMG150608				●	●	●	●				●	●	●												0.8	12.7	6.35	5.16
DNMG150612				●	●	●	●				●	●	●												1.2	12.7	6.35	5.16
DNMG150616				●	●						●	●													1.6	12.7	6.35	5.16
Medium cutting		SM DNMG110404E-SM					●							●									0.4	9.525	4.76	3.81		
		DNMG110408E-SM					●								●									0.8	9.525	4.76	3.81	
		DNMG150404-SM					●								●	●								0.4	12.7	4.76	5.16	
		DNMG150408-SM					●								●	●								0.8	12.7	4.76	5.16	
		DNMG150412-SM					●								●	●								1.2	12.7	4.76	5.16	
		DNMG150604-SM					●								●	●								0.4	12.7	6.35	5.16	
		DNMG150608-SM					●								●	●								0.8	12.7	6.35	5.16	
		DNMG150612-SM					●								●	●								1.2	12.7	6.35	5.16	
		SDM DNMG150404-SDM					●						●	●	●	●								0.4	12.7	4.76	5.16	
		DNMG150408-SDM					●							●	●	●	●								0.8	12.7	4.76	5.16
		DNMG150412-SDM					●								●	●									1.2	12.7	4.76	5.16
		DNMG150604-SDM					●								●	●									0.4	12.7	6.35	5.16
		DNMG150608-SDM					●								●	●	●	●							0.8	12.7	6.35	5.16
		DNMG150612-SDM					●								●	●	●	●							1.2	12.7	6.35	5.16
			HRM DNMG150404-HRM												●	●									1.2	12.7	6.35	5.16
			DNMG150408-HRM													●	●									0.4	12.7	4.76
DNMG150412-HRM														●	●									0.8	12.7	4.76	5.16	
DNMG150604-HRM														●	●									1.2	12.7	4.76	5.16	
DNMG150608-HRM														●	●									0.4	12.7	6.35	5.16	
DNMG150612-HRM														●	●									0.8	12.7	6.35	5.16	

● : Line up

Reference pages: External toolholder → C034 - Internal toolholder → D069 -
 J-Series toolholder → G068 TungCap → C034 -, K012 -

Insert NEGATIVE TYPE

- : Continuous cutting
- ◐ : Light interrupted cutting
- ◑ : Heavy interrupted cutting

DN

Rhombic, 55°
with hole

P	Steel	●●◐◑									●●									
M	Stainless	●●									●●			●●●●						
K	Cast iron	●●		●●◐◑		●	◐	◑	◑		●●			●●●●						
N	Non-ferrous																			
S	Superalloy										◐◑									
H	Hard material																			

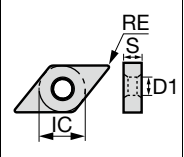

Application	Chipbreaker	Designation	Coated								Coated cermet		Cermet	Dimension (mm)				
			T9215	T9225	T505	T515	T5105	T5115	T5125	AH905	AH120	GT9530	AT9530	NS9530	RE	IC	S	D1
Medium cutting		CM DNMG150404-CM			●	●	●	●	●					0.4	12.7	4.76	5.16	
		DNMG150408-CM			●	●	●	●	●					0.8	12.7	4.76	5.16	
		DNMG150412-CM			●	●	●	●	●					1.2	12.7	4.76	5.16	
		DNMG150604-CM					●	●	●	●					0.4	12.7	6.35	5.16
		DNMG150608-CM					●	●	●	●					0.8	12.7	6.35	5.16
		DNMG150612-CM					●	●	●	●					1.2	12.7	6.35	5.16
Finishing (wiper)		SW DNMG110408E-SW	●											0.8	9.525	4.76	3.81	
		DNMG110412E-SW	●											1.2	9.525	4.76	3.81	
		DNMG150408-SW	●												0.8	12.7	4.76	5.16
		DNMG150412-SW	●												1.2	12.7	4.76	5.16
		DNMG150608-SW	●												0.8	12.7	6.35	5.16
		DNMG150612-SW	●												1.2	12.7	6.35	5.16
Medium cutting		TQ DNMG150404-TQ	●	●							●	●		0.4	12.7	4.76	5.16	
		DNMG150408-TQ	●	●							●	●		0.8	12.7	4.76	5.16	
		SA DNMG150404-SA								●					0.4	12.7	4.76	5.16
		DNMG150408-SA								●					0.8	12.7	4.76	5.16
		DNMG150604-SA								●					0.4	12.7	6.35	5.16
		DNMG150608-SA								●					0.8	12.7	6.35	5.16
Medium cutting		HMM DNMG150404-HMM							●					0.4	12.7	4.76	5.16	
		DNMG150408-HMM							●					0.8	12.7	4.76	5.16	
		DNMG150412-HMM							●					1.2	12.7	4.76	5.16	

* Please see L011 - L015 about the adjustment of the machining program for rounding or taper machining by using SW/FW. Please contact our sales representatives if you have any question.

● : Line up

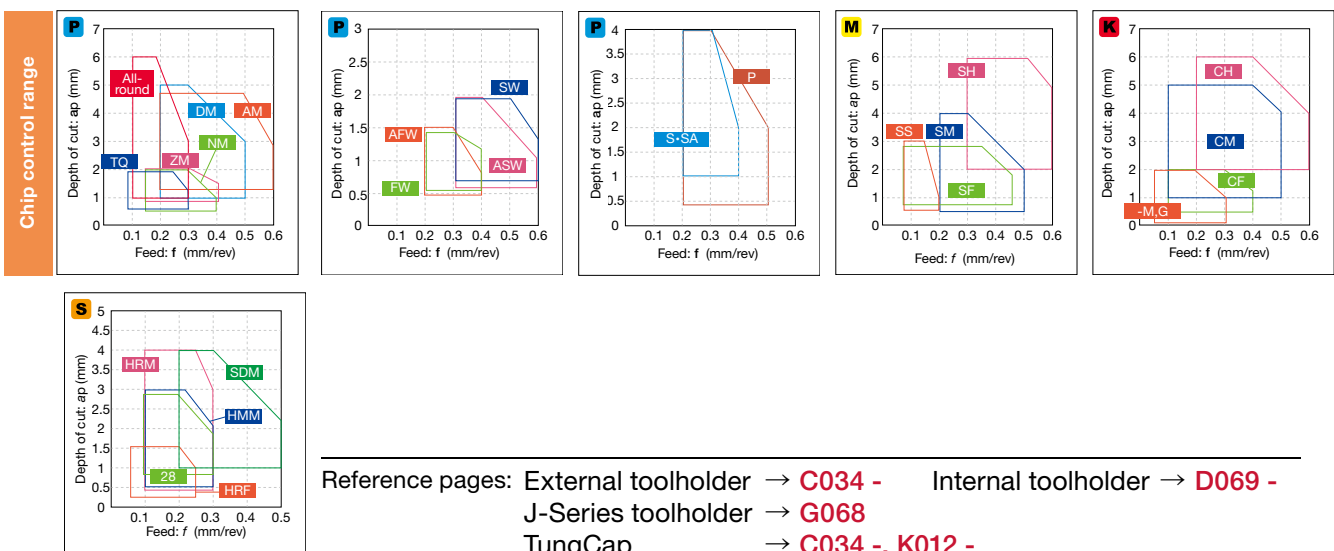

Reference pages: External toolholder → C034 - Internal toolholder → D069 -
 J-Series toolholder → G068
 TungCap → C034 -, K012 -

Grade: A, B, C, D, E, F, G, H, I, J, K, L, M
 Insert: B, C, D, E, F, G, H, I, J, K, L, M
 Toolholder: Ext. Toolholder, Int. Toolholder, Threading, Grooving, Miniature tool, Milling cutter, Endmill, Drilling tool, Tooling System, User's Guide, Index

Insert NEGATIVE TYPE

● : Continuous cutting
 ● : Light interrupted cutting
 * : Heavy interrupted cutting

DN

Rhombic, 55° with hole

	P	M	K	N	S	H	Coated	Coated cermet	Cermet	Uncoated	Others
Steel	●	●	●	●	●	●	●	●	●	●	●
Stainless	●	●	●	●	●	●	●	●	●	●	●
Cast iron	●	●	●	●	●	●	●	●	●	●	●
Non-ferrous	●	●	●	●	●	●	●	●	●	●	●
Superalloy	●	●	●	●	●	●	●	●	●	●	●
Hard material	●	●	●	●	●	●	●	●	●	●	●

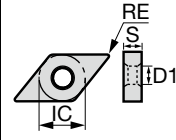

Application	Chipbreaker	Designation	Coated								Coated cermet	Cermet	Uncoated	Dimension (mm)							
			T9215	T9225	T9235	AH8005	AH8015	AH6225	AH6235	AH110	AH120	GH110	GH330	GT9530	NS9530	TH10	KS05F	RE	IC	S	D1
Medium cutting		P DNGG150402R-P												●			0.2	12.7	4.76	5.16	
		DNGG150402L-P													●			0.2	12.7	4.76	5.16
		DNGG150404R-P													●			0.4	12.7	4.76	5.16
		DNGG150404L-P													●			0.4	12.7	4.76	5.16
		DNGG150408R-P													●			0.8	12.7	4.76	5.16
		DNGG150408L-P													●			0.8	12.7	4.76	5.16
		S DNMG150404R-S	●	●			●	●						●			0.4	12.7	4.76	5.16	
		DNMG150404L-S	●	●			●	●						●			0.4	12.7	4.76	5.16	
		DNMG150408R-S	●	●			●	●						●			0.8	12.7	4.76	5.16	
		DNMG150408L-S	●	●			●	●						●			0.8	12.7	4.76	5.16	
		DNMG150604R-S	●	●			●	●									0.4	12.7	6.35	5.16	
		DNMG150604L-S	●	●			●	●									0.4	12.7	6.35	5.16	
		DNMG150608R-S	●	●			●	●				●					0.8	12.7	6.35	5.16	
		DNMG150608L-S	●	●			●	●									0.8	12.7	6.35	5.16	
		27 DNMG150404-27	●											●			0.4	12.7	4.76	5.16	
		DNMG150408-27	●	●										●			0.8	12.7	4.76	5.16	
		DNMG150412-27	●														1.2	12.7	4.76	5.16	
		28 DNMG150404-28			●	●									●		0.4	12.7	4.76	5.16	
		DNMG150408-28			●	●									●		0.8	12.7	4.76	5.16	
		DNMG150604-28			●	●									●		0.4	12.7	6.35	5.16	
		DNMG150608-28			●	●									●		0.8	12.7	6.35	5.16	
		33 DNMG150404-33							●								0.4	12.7	4.76	5.16	
		DNMG150408-33							●						●		0.8	12.7	4.76	5.16	
		37 DNMG150404-37												●			0.4	12.7	4.76	5.16	
		DNMG150408-37												●			0.8	12.7	4.76	5.16	
		DNMG150608-37	●														0.8	12.7	6.35	5.16	
		38 DNMG150412-38	●														1.2	12.7	4.76	5.16	
		Parallel DNGG150404R									●	●					0.4	12.7	4.76	5.16	
		DNGG150404L									●	●					0.4	12.7	4.76	5.16	
		DNGG150408R										●					0.8	12.7	4.76	5.16	
DNGG150408L											●					0.8	12.7	4.76	5.16		

● : Line up

Reference pages: External toolholder → **C034 -**
 J-Series toolholder → **G068**

Internal toolholder → **D069 -**
 TungCap → **C034 -, K012 -**

Insert NEGATIVE TYPE

- : Continuous cutting
- ◐ : Light interrupted cutting
- ◑ : Heavy interrupted cutting

DN

Rhombic, 55° with hole

	P Steel	M Stainless	K Cast iron	N Non-ferrous	S Superalloy	H Hard material	Coated	Coated cermet	Cermet	Uncoated								
●	●	●	●															
◐																		
◑																		
*																		

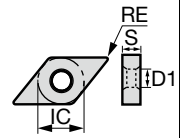

Application	Chipbreaker	Designation	Coated												Coated cermet	Cermet	Uncoated	Dimension (mm)				
			T9215	T9225	T9235	T505	T515	T5105	T5115	T5125	AH8015	AH6225	AH6235	AH120	GT720	NS520	TH10	RE	IC	S	D1	
Medium to heavy cutting		TH DNMG150408-TH	●	●	●		●			●		●						0.8	12.7	4.76	5.16	
		DNMG150412-TH	●	●	●		●			●		●						1.2	12.7	4.76	5.16	
		DNMG150416-TH	●	●									●						1.6	12.7	4.76	5.16
		DNMG150608-TH	●	●	●								●						0.8	12.7	6.35	5.16
		DNMG150612-TH	●	●	●								●						1.2	12.7	6.35	5.16
		DNMG150616-TH	●	●															1.6	12.7	6.35	5.16
		THS DNMG150408-THS	●	●	●													0.8	12.7	4.76	5.16	
		DNMG150412-THS	●	●	●														1.2	12.7	4.76	5.16
		DNMG150416-THS	●	●															1.6	12.7	4.76	5.16
		DNMG150608-THS	●	●	●														0.8	12.7	6.35	5.16
		DNMG150612-THS	●	●	●														1.2	12.7	6.35	5.16
		DNMG150616-THS	●	●															1.6	12.7	6.35	5.16
		SH DNMG150408-SH											●	●				0.8	12.7	4.76	5.16	
		DNMG150412-SH											●	●				1.2	12.7	4.76	5.16	
		DNMG150416-SH											●	●				1.6	12.7	4.76	5.16	
		DNMG150608-SH											●	●				0.8	12.7	6.35	5.16	
		DNMG150612-SH											●	●				1.2	12.7	6.35	5.16	
		CH DNMG150404-CH					●	●	●									0.4	12.7	4.76	5.16	
		DNMG150408-CH					●	●	●									0.8	12.7	4.76	5.16	
DNMG150412-CH						●	●	●									1.2	12.7	4.76	5.16		
DNMG150604-CH						●	●	●									0.4	12.7	6.35	5.16		
DNMG150608-CH						●	●	●									0.8	12.7	6.35	5.16		
DNMG150612-CH						●	●	●									1.2	12.7	6.35	5.16		
Medium to heavy cutting (single side)		57 DNMM150608-57		●													0.8	12.7	6.35	5.16		
		DNMM150612-57		●														1.2	12.7	6.35	5.16	
Finishing to medium cutting		DNMA110404E										●					0.4	9.525	4.76	3.81		
		DNMA110408E										●					0.8	9.525	4.76	3.81		
		DNMA110412E										●					1.2	9.525	4.76	3.81		
		DNMA150404				●	●	●	●	●			●					0.4	12.7	4.76	5.16	
		DNMA150408				●	●	●	●	●			●					0.8	12.7	4.76	5.16	
		DNMA150412				●	●	●	●	●			●					1.2	12.7	4.76	5.16	
		DNMA150604				●	●	●	●	●								0.4	12.7	6.35	5.16	
		DNMA150608				●	●	●	●	●								0.8	12.7	6.35	5.16	
DNMA150612				●	●	●	●	●								1.2	12.7	6.35	5.16			

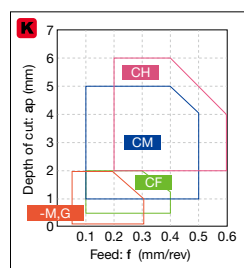
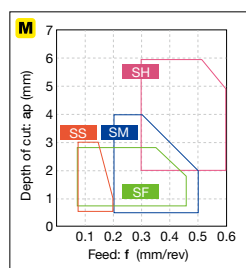
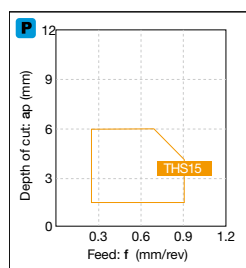
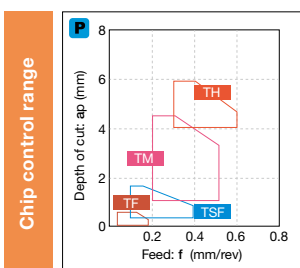

*-M,G: Without chipbreaker

Reference pages: External toolholder → **C034 - J-Series toolholder → G068**

Internal toolholder → **D069 - TungCap → C034 -, K012 -**

Grade
Insert
Toolholder
Ext. Toolholder
Int. Toolholder
Threading
Grooving
Miniature tool
Milling cutter
Endmill
Drilling tool
Tooling System
Index
User's Guide

A
B
C
D
E
F
G
H
I
J
K
L
M

Insert NEGATIVE TYPE

● : Continuous cutting
 ● : Light interrupted cutting
 ✱ : Heavy interrupted cutting

DN

Rhombic, 55° with hole

P	Steel	●●
M	Stainless	●
K	Cast iron	●●
N	Non-ferrous	●
S	Superalloy	
H	Hard material	●●●●●●

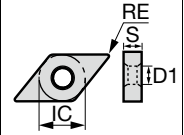

Application	Chipbreaker	Designation	Cermet		Uncoated		Ceramic				Dimension (mm)				
			NS520	TH10	FX105	LX10	LX11	LX21	RE	IC	S	D1			
Finishing to medium cutting	-	DNGA150404	●	●	●	●	▲	●				0.4	12.7	4.76	5.16
		DNGA150408	●	●	●	●	▲	●				0.8	12.7	4.76	5.16
		DNGA150412			●	●	▲	●				1.2	12.7	4.76	5.16
		DNGA150416			●	●	▲	●				1.6	12.7	4.76	5.16
		DNGA150604				●	▲					-	-	-	-
		DNGA150608				●	▲					0.8	12.7	6.35	5.16
		DNGA150612				●	▲					1.2	12.7	6.35	5.16
		DNGA150616				●	▲					1.6	12.7	6.35	5.16
		DNGA150620				●	▲					2	12.7	6.35	5.16

DN

Rhombic, 55° without hole

P	Steel	
M	Stainless	
K	Cast iron	●●
N	Non-ferrous	
S	Superalloy	
H	Hard material	●●●●

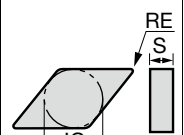

Application	Chipbreaker	Designation	Ceramic			Dimension (mm)			
			FX105	LX10	LX11	RE	IC	S	D1
Finishing to medium cutting	-	DNGD150708	●			0.8	12.7	7.94	-
		DNGD150712	●			1.2	12.7	7.94	-
		DNGD150716	●			1.6	12.7	7.94	-
Finishing to medium cutting	-	DNGN150404			▲	0.4	12.7	4.76	-
		DNGN150408		●	▲	0.8	12.7	4.76	-
		DNGN150412		●	▲	1.2	12.7	4.76	-
		DNGN150416		●		1.6	12.7	4.76	-
		DNGN150708		●	▲	0.8	12.7	7.94	-
		DNGN150712		●	▲	1.2	12.7	7.94	-
		DNGN150716		●	▲	1.6	12.7	7.94	-

● : Line up
 ▲ : To be discontinued

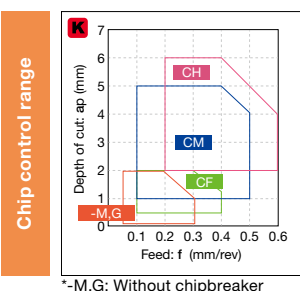

Reference pages: DNGA...: External toolholder → C034 -, Internal toolholder → D069 -, J-Series toolholder → G068, TungCap → C034 -, K012 - DNGD...: External toolholder → C040

Insert NEGATIVE TYPE

- : Continuous cutting
- ◐ : Light interrupted cutting
- ◑ : Heavy interrupted cutting

SN



Square with hole

Material	P Steel	M Stainless	K Cast iron	N Non-ferrous	S Superalloy	H Hard material	Coated	Coated cermet	Cermet	Other
●	●	●	●	●	●	●	●	●	●	●
◐	◐	◐	◐	◐	◐	◐	◐	◐	◐	◐
◑	◑	◑	◑	◑	◑	◑	◑	◑	◑	◑

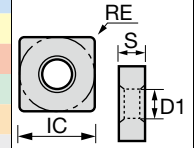

Application	Chipbreaker	Designation	Coated						Coated cermet	Cermet	Dimension (mm)			
			T9205	T9215	T9225	T6215	AH8015	AH6225	GT9530 AT9530	NS9530	RE	IC	S	D1
Finishing	TF	SNMG120404-TF	●	●	●	●	●			●	0.4	12.7	4.76	5.16
		SNMG120408-TF	●	●	●	●	●			●	0.8	12.7	4.76	5.16
	TSF	SNMG120402-TSF	●	●	●	●	●			●	0.2	12.7	4.76	5.16
		SNMG120404-TSF	●	●	●	●	●	●	●	●	0.4	12.7	4.76	5.16
		SNMG120408-TSF	●	●	●	●	●	●	●	●	0.8	12.7	4.76	5.16
		SNMG120412-TSF	●	●	●	●	●			●	1.2	12.7	4.76	5.16
	PS	SNMG120402-PS	●	●	●	●	●				0.2	12.7	4.76	5.16
		SNMG120404-PS	●	●	●	●	●			●	0.4	12.7	4.76	5.16
		SNMG120408-PS	●	●	●	●	●			●	0.8	12.7	4.76	5.16
		SNMG120412-PS	●	●	●	●	●				1.2	12.7	4.76	5.16
Finishing for mild steel	ZF	SNMG120402-ZF	●	●	●	●	●			●	0.2	12.7	4.76	5.16
		SNMG120404-ZF	●	●	●	●	●			●	0.4	12.7	4.76	5.16
		SNMG120408-ZF	●	●	●	●	●			●	0.8	12.7	4.76	5.16
		SNMG120412-ZF	●	●	●	●	●			●	1.2	12.7	4.76	5.16
Finishing	AS	SNMG120404-AS								●	0.4	12.7	4.76	5.16
		SNMG120408-AS	●	●						●	0.8	12.7	4.76	5.16
	NS	SNMG120408-NS		●	●						0.8	12.7	4.76	5.16

● : Line up

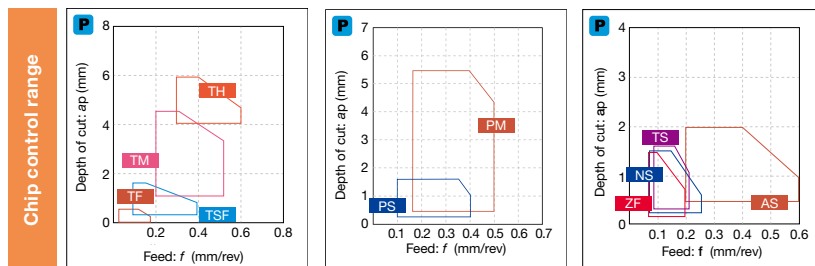

Reference pages: External toolholder → C101 - Internal toolholder → D043 -
Cartridge → K181 -

Grade
Insert
Ext. Toolholder
Int. Toolholder
Threading
Grooving
Miniature tool
Milling cutter
Endmill
Drilling tool
Tooling System
User's Guide
Index



Insert NEGATIVE TYPE

● : Continuous cutting
 ● : Light interrupted cutting
 * : Heavy interrupted cutting

SN



	P	M	K	N	S	H	Coated	Coated cermet	Cermet	Uncoated
Steel	●	●	●	●	●	●	●	●	●	●
Stainless	●	●	●	●	●	●	●	●	●	●
Cast iron	●	●	●	●	●	●	●	●	●	●
Non-ferrous	●	●	●	●	●	●	●	●	●	●
Superalloy	●	●	●	●	●	●	●	●	●	●
Hard material	●	●	●	●	●	●	●	●	●	●

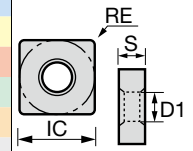

Application	Chipbreaker	Designation	Coated										Coated cermet		Cermet		Uncoated	Dimension (mm)					
			T9205	T9215	T9225	T9235	T6215	T5105	T5115	AH8005	AH8015	AH6225	AH6235	GH330	GT9530	AT9530		NS9530	NS520	TH10	RE	IC	S
Application		TS SNMG120404-TS	●	●	●	●									●	●	●	●		0.4	12.7	4.76	5.16
		SNMG120408-TS	●	●	●	●									●	●				0.8	12.7	4.76	5.16
		SNMG120412-TS	●	●	●	●												●			1.2	12.7	4.76
Application		SF SNMG120404-SF					●				●									0.4	12.7	4.76	5.16
		SNMG120408-SF					●				●									0.8	12.7	4.76	5.16
Application		SS SNMG120404-SS					●				●	●	●							0.4	12.7	4.76	5.16
		SNMG120408-SS					●				●	●	●							0.8	12.7	4.76	5.16
		SNMG120412-SS					●				●	●								1.2	12.7	4.76	5.16
Application		HRF SNMG120408-HRF								●	●								0.8	12.7	4.76	5.16	
		SNMG120412-HRF								●	●								1.2	12.7	4.76	5.16	
Application		CF SNMG120408-CF					●	●											0.8	12.7	4.76	5.16	
		SNMG120412-CF					●	●											1.2	12.7	4.76	5.16	
Application		01 SNGG090302-01															●	●	0.2	9.525	3.18	3.81	
		SNGG090304-01																●		0.4	9.525	3.18	3.81
		SNGG090308-01																●	●	0.8	9.525	3.18	3.81
		SNGG120402-01																●		0.2	12.7	4.76	5.16
		SNGG120404-01																●		0.4	12.7	4.76	5.16
		SNGG120408-01																●	●	0.8	12.7	4.76	5.16
Application		11 SNMG120404-11															●		0.4	12.7	4.76	5.16	
		SNMG120408-11															●		0.8	12.7	4.76	5.16	

● : Line up

Reference pages: External toolholder → **C101** - Internal toolholder → **D043** -
 Cartridge → **K181** -

Insert NEGATIVE TYPE

● : Continuous cutting
● : Light interrupted cutting
* : Heavy interrupted cutting

SN



Square
with hole

	P Steel	M Stainless	K Cast iron	N Non-ferrous	S Superalloy	H Hard material														
●	●	●	●	●	●	●	●	●	●	●	●	●	●	●	●	●	●	●	●	●
●	●	●	●	●	●	●	●	●	●	●	●	●	●	●	●	●	●	●	●	●
*																				

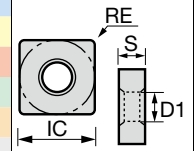

Application	Chipbreaker	Designation	Coated			Coated cermet	Cermet	Dimension (mm)										
			T9205	T9215	T9225	T9235	T6215	AH8015	AH6225	AH120	GT9530	NS9530	X407	RE	IC	S	D1	
Finishing for mild steel	17	SNMG120408-17									●		0.8	12.7	4.76	5.16		
Finishing	B ~ D	SNGG090304R-B						●			● ●		0.4	9.525	3.18	3.81		
		SNGG090304L-B						●			● ●		0.4	9.525	3.18	3.81		
		SNGG090308R-B										● ●		0.8	9.525	3.18	3.81	
		SNGG090308L-B										● ●		0.8	9.525	3.18	3.81	
		SNGG120404R-C							●			●		0.4	12.7	4.76	5.16	
		SNGG120404L-C							●			● ●		0.4	12.7	4.76	5.16	
		SNGG120408R-C											●		0.8	12.7	4.76	5.16
		SNGG120408L-C											● ●		0.8	12.7	4.76	5.16
		SNGG120408R-D											●		0.8	12.7	4.76	5.16
		SNGG120408L-D										●		0.8	12.7	4.76	5.16	
Medium cutting	TM	SNMG090304-TM	● ● ●										0.4	9.525	3.18	3.81		
		SNMG090308-TM	● ● ●										0.8	9.525	3.18	3.81		
		SNMG120404-TM	● ● ● ● ● ● ● ●										0.4	12.7	4.76	5.16		
		SNMG120408-TM	● ● ● ● ● ● ● ●										0.8	12.7	4.76	5.16		
		SNMG120412-TM	● ● ● ● ● ● ● ●										1.2	12.7	4.76	5.16		
		SNMG120416-TM	● ● ● ● ● ● ● ●										1.6	12.7	4.76	5.16		
		SNMG150608-TM	●											0.8	15.875	6.35	6.35	
		SNMG150612-TM	●				●							1.2	15.875	6.35	6.35	
		SNMG190608-TM	●					●						0.8	19.05	6.35	7.93	
		SNMG190612-TM	●					●						1.2	19.05	6.35	7.93	
		PM	SNMG120404-PM	● ● ● ● ● ● ● ●										0.4	12.7	4.76	5.16	
			SNMG120408-PM	● ● ● ● ● ● ● ●										0.8	12.7	4.76	5.16	
SNMG120412-PM	● ● ● ● ● ● ● ●											1.2	12.7	4.76	5.16			
SNMG120416-PM	● ● ● ● ● ● ● ●											1.6	12.7	4.76	5.16			

● : Line up

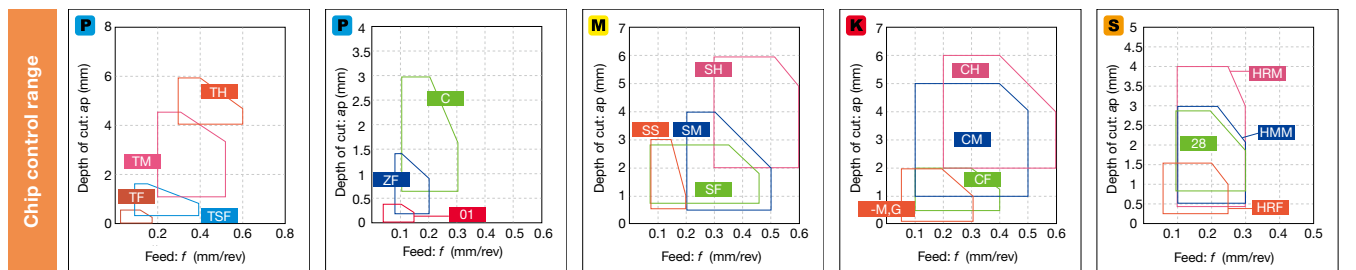

*-M,G: Without chipbreaker

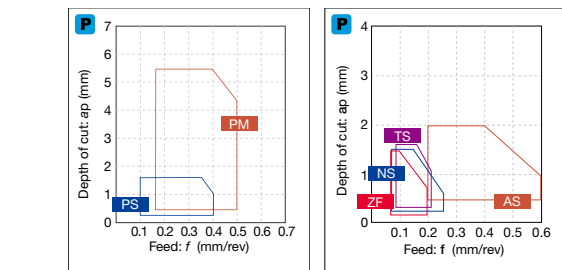

Reference pages: External toolholder → **C101** -
Internal toolholder → **D043** -
Cartridge → **K181** -

Grade
Insert
Ext. Toolholder
Int. Toolholder
Threading
Grooving
Milling cutter
Miniature tool
Endmill
Drilling tool
Tooling System
User's Guide
Index

A
B
C
D
E
F
G
H
I
J
K
L
M

Insert NEGATIVE TYPE

● : Continuous cutting
 ● : Light interrupted cutting
 * : Heavy interrupted cutting

SN



Material	P Steel	M Stainless	K Cast iron	N Non-ferrous	S Superalloy	H Hard material	T9215	T9225	T6215	AH8005	AH8015	AH6225	AH6235	AH905	AH120	GH110	GH330	TH10	KS20	
●	●	●	●	●	●	●	●	●	●	●	●	●	●	●	●	●	●	●	●	●
●	●	●	●	●	●	●	●	●	●	●	●	●	●	●	●	●	●	●	●	●
●	●	●	●	●	●	●	●	●	●	●	●	●	●	●	●	●	●	●	●	●
●	●	●	●	●	●	●	●	●	●	●	●	●	●	●	●	●	●	●	●	●
●	●	●	●	●	●	●	●	●	●	●	●	●	●	●	●	●	●	●	●	●
●	●	●	●	●	●	●	●	●	●	●	●	●	●	●	●	●	●	●	●	●

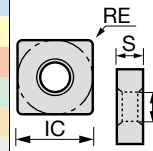

Application	Chipbreaker	Designation	Coated														Uncoated		Dimension (mm)						
			T9215	T9225	T6215	AH8005	AH8015	AH6225	AH6235	AH905	AH120	GH110	GH330	TH10	KS20	RE	IC	S	D1						
																	TH10	KS20	RE	IC	S	D1			
Medium cutting	HRM	SNMG120408-HRM				●	●														0.8	12.7	4.76	5.16	
		SNMG120412-HRM				●	●															1.2	12.7	4.76	5.16
		SNMG150608-HRM				●	●															0.8	15.875	6.35	6.35
		SNMG150612-HRM				●	●															1.2	15.875	6.35	6.35
		SNMG190612-HRM				●	●															1.2	19.05	6.35	7.93
		SNMG190616-HRM				●	●															1.6	19.05	6.35	7.93
	TA	SNMG120408-TA	●	●																		0.8	12.7	4.76	5.16
		SNMG120412-TA	●	●																		1.2	12.7	4.76	5.16
	SA	SNMG120404-SA			●		●	●		●												0.4	12.7	4.76	5.16
		SNMG120408-SA			●		●	●		●						●						0.8	12.7	4.76	5.16
SNMG120412-SA				●		●	●		●						●						1.2	12.7	4.76	5.16	
SNMG190612-SA															●						1.2	19.05	6.35	7.93	
HMM	SNMG120408-HMM														●						0.8	12.7	4.76	5.16	
	SNMG120412-HMM														●						1.2	12.7	4.76	5.16	
P	SNGG090304R-P															●			●		0.4	9.525	3.18	3.81	
	SNGG090304L-P															●			●		0.4	9.525	3.18	3.81	
	SNGG090308R-P															●	●		●		0.8	9.525	3.18	3.81	
	SNGG090308L-P															●			●		0.8	9.525	3.18	3.81	
	SNGG120404R-P															●			●		0.4	12.7	4.76	5.16	
	SNGG120404L-P															●			●		0.4	12.7	4.76	5.16	
	SNGG120408R-P															●			●		0.8	12.7	4.76	5.16	
	SNGG120408L-P															●			●		0.8	12.7	4.76	5.16	

● : Line up

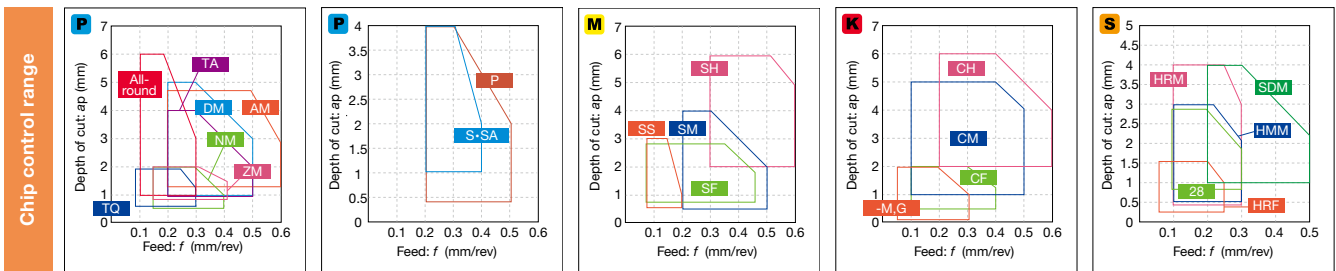

Reference pages: External toolholder → **C101** - Cartridge → **K181** - Internal toolholder → **D043** -

Grade
 Insert
 Ext. Toolholder
 Int. Toolholder
 Threading
 Grooving
 Miniature tool
 Milling cutter
 Endmill
 Drilling tool
 Tooling System
 Tooling Guide
 User's Guide
 Index

Insert NEGATIVE TYPE

● : Continuous cutting
 ●● : Light interrupted cutting
 ●●● : Heavy interrupted cutting

SN



Square with hole

Material	P	M	K	N	S	H	T9205	T9215	T9225	T9235	AH6225	AH6235	AH120	GH330	NS9530
Steel	●●●●●●	●●●●●●	●●●●●●	●●●●●●	●●●●●●	●●●●●●	●	●●	●●●	●●●●	●●●●	●●●●	●●●●	●●●●	●●
Stainless	●●●●●●	●●●●●●	●●●●●●	●●●●●●	●●●●●●	●●●●●●	●	●●	●●●	●●●●	●●●●	●●●●	●●●●	●●●●	●●
Cast iron	●●●●●●	●●●●●●	●●●●●●	●●●●●●	●●●●●●	●●●●●●	●	●●	●●●	●●●●	●●●●	●●●●	●●●●	●●●●	●●
Non-ferrous	●●●●●●	●●●●●●	●●●●●●	●●●●●●	●●●●●●	●●●●●●	●	●●	●●●	●●●●	●●●●	●●●●	●●●●	●●●●	●●
Superalloy	●●●●●●	●●●●●●	●●●●●●	●●●●●●	●●●●●●	●●●●●●	●	●●	●●●	●●●●	●●●●	●●●●	●●●●	●●●●	●●
Hard material	●●●●●●	●●●●●●	●●●●●●	●●●●●●	●●●●●●	●●●●●●	●	●●	●●●	●●●●	●●●●	●●●●	●●●●	●●●●	●●

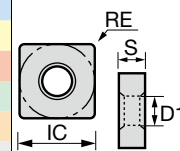

Application	Chipbreaker	Designation	Coated														Cermet	Dimension (mm)								
			T9205	T9215	T9225	T9235	AH6225	AH6235	AH120	GH330															NS9530	RE
Medium cutting		S SNMG120404R-S		●	●	●	●												●	0.4	12.7	4.76	5.16			
		SNMG120404L-S		●	●	●	●													●	0.4	12.7	4.76	5.16		
		SNMG120408R-S		●	●	●	●		●											●	0.8	12.7	4.76	5.16		
		SNMG120408L-S		●	●	●	●		●											●	0.8	12.7	4.76	5.16		
		27 SNMG120408-27			●															●	0.8	12.7	4.76	5.16		
		SNMG120412-27			●														●	1.2	12.7	4.76	5.16			
		33 SNMG120408-33		●	●															0.8	12.7	4.76	5.16			
		SNMG120412-33			●															1.2	12.7	4.76	5.16			
		SNMG150612-33		●	●															1.2	15.875	6.35	6.35			
		SNMG190616-33			●	●														1.6	19.05	6.35	7.93			
		37 SNMG120408-37			●					●										●	0.8	12.7	4.76	5.16		
		SNMG120412-37			●														●	1.2	12.7	4.76	5.16			
	Medium to heavy cutting		TH SNMG120408-TH		●	●	●						●							0.8	12.7	4.76	5.16			
			SNMG120412-TH			●	●	●						●						1.2	12.7	4.76	5.16			
			SNMG150612-TH		●	●	●							●						1.2	15.875	6.35	6.35			
			SNMG150616-TH		●	●	●							●						1.6	15.875	6.35	6.35			
			SNMG190612-TH		●	●	●	●						●						1.2	19.05	6.35	7.93			
			SNMG190616-TH		●	●	●	●						●						1.6	19.05	6.35	7.93			
			THS SNMG120408-THS		●	●	●													0.8	12.7	4.76	5.16			
			SNMG120412-THS			●	●	●												1.2	12.7	4.76	5.16			
			SNMG150612-THS		●	●														1.2	15.875	6.35	6.35			
			SNMG150616-THS		●	●														1.6	15.875	6.35	6.35			
			SNMG190608-THS		●	●	●													0.8	19.05	6.35	7.93			
			SNMG190612-THS		●	●	●													1.2	19.05	6.35	7.93			
	SNMG190616-THS		●	●	●												1.6	19.05	6.35	7.93						
	SNMG190624-THS		●	●	●												2.4	19.05	6.35	7.93						
	SNMG250716-THS		●	●	●												1.6	25.4	7.94	9.12						
	SNMG250724-THS		●	●	●												2.4	25.4	7.94	9.12						

● : Line up

Reference pages: External toolholder → C101 - Internal toolholder → D043 -
 Cartridge → K181 -

Insert NEGATIVE TYPE

- : Continuous cutting
- ◐ : Light interrupted cutting
- ✱ : Heavy interrupted cutting

SN

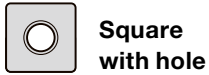

Material	Grade	Line up	Line up	Line up	Line up	Line up	Line up	Line up	Line up	Line up	Line up	Line up	Line up	Line up	Line up	Line up	Line up	Line up	Line up	Line up	
P Steel	●◐✱																				
M Stainless	●◐																				
K Cast iron	●◐			●	◐	✱															
N Non-ferrous																					
S Superalloy																					
H Hard material																					

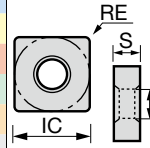

Application	Chipbreaker	Designation	Coated								Dimension (mm)				
			T9215	T9225	T9235	T5105	T5115	T5125	AH6225	AH6235	RE	IC	S	D1	
Medium to heavy cutting		SH SNMG120408-SH							●	●	0.8	12.7	4.76	5.16	
		SNMG120412-SH							●	●	1.2	12.7	4.76	5.16	
		SNMG150612-SH							●	●	1.2	15.875	6.35	6.35	
		SNMG150616-SH							●	●	1.6	15.875	6.35	6.35	
		SNMG190612-SH							●	●	1.2	19.05	6.35	7.93	
		SNMG190616-SH							●	●	1.6	19.05	6.35	7.93	
		CH SNMG120408-CH			●	●	●				0.8	12.7	4.76	5.16	
		SNMG120412-CH			●	●	●				1.2	12.7	4.76	5.16	
		SNMG120416-CH			●	●	●				1.6	12.7	4.76	5.16	
	Medium to heavy cutting (single side)		TRS SNMM150612-TRS	●	●	●						1.2	15.875	6.35	6.35
SNMM150616-TRS			●	●	●						1.6	15.875	6.35	6.35	
SNMM190616-TRS			●	●	●						1.6	19.05	6.35	7.93	
SNMM190624-TRS			●	●	●						2.4	19.05	6.35	7.93	
SNMM250924-TRS			●	●	●						2.4	25.4	9.52	9.12	
		57 SNMM120408-57	●	●							0.8	12.7	4.76	5.16	
		SNMM150616-57	●								1.6	15.875	6.35	6.35	
		SNMM190612-57	●								1.2	19.05	6.35	7.93	
			65 SNMM190612-65	●								1.2	19.05	6.35	7.93
			SNMM190624-65	●								2.4	19.05	6.35	7.93
SNMM310924-65	●									2.4	31.75	9.52	8.8		

● : Line up

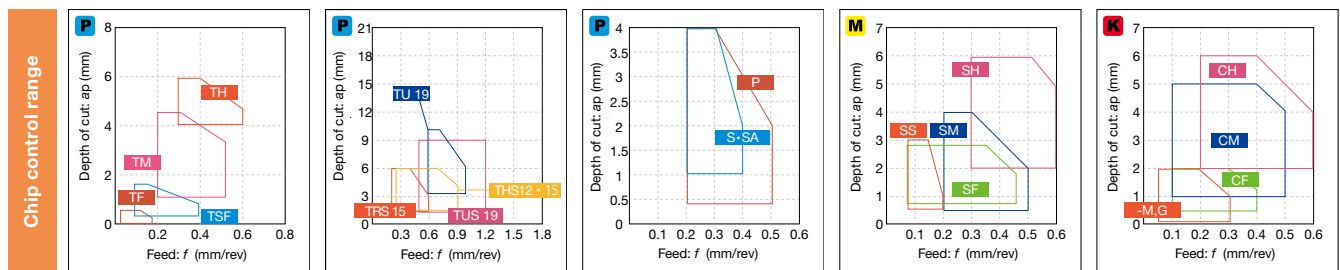

*-M,G: Without chipbreaker

Reference pages: External toolholder → C101 - Internal toolholder → D043 -
Cartridge → K181 -

Insert NEGATIVE TYPE

- : Continuous cutting
- ◐ : Light interrupted cutting
- ✱ : Heavy interrupted cutting

SN



	P Steel	M Stainless	K Cast iron	N Non-ferrous	S Superalloy	H Hard material	Coated	Coated cermet	Cermet	Uncoated	Ceramic	Dimension (mm)
	●●●✱	●●	●●				●●●●●	●●	●●	●●	●●●●●	
			●●●●●	●●●●●	●●●●●	●●●●●	●●●●●	●●	●●	●●	●●●●●	
				●●●●●	●●●●●	●●●●●	●●●●●	●●	●●	●●	●●●●●	
					●●●●●	●●●●●	●●●●●	●●	●●	●●	●●●●●	
						●●●●●	●●●●●	●●	●●	●●	●●●●●	

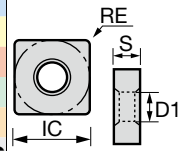

Application	Chipbreaker	Designation	Coated								Coated cermet	Cermet	Uncoated	Ceramic		Dimension (mm)					
			T9215	T9225	T9235	T505	T515	T5105	T5115	T5125	GT720	NS520	TH10	FX105	LX10	LX11	LX21	RE	IC	S	D1
Heavy cutting (single side)		TU SNMM190616-TU			●												1.6	19.05	6.35	7.93	
		SNMM190624-TU	●	●													2.4	19.05	6.35	7.93	
		SNMM250724-TU	●	●													2.4	25.4	7.94	9.12	
		SNMM250924-TU	●	●													2.4	25.4	9.52	9.12	
	TUS SNMM190612-TUS	●	●	●													1.2	19.05	6.35	7.93	
Finishing to medium cutting		TUS SNMM190616-TUS	●	●	●											1.6	19.05	6.35	7.93		
		SNMM190624-TUS	●	●	●												2.4	19.05	6.35	7.93	
		SNMM250724-TUS	●	●	●												2.4	25.4	7.94	9.12	
		SNMM250732-TUS	●	●													3.2	25.4	7.94	9.12	
		SNMM250924-TUS	●	●	●												2.4	25.4	9.52	9.12	
	SNMM250932-TUS	●	●													3.2	25.4	9.52	9.12		
		SNMA090308					●				●					0.8	9.525	3.18	3.81		
		SNMA120404				●	●	●		●						0.4	12.7	4.76	5.16		
		SNMA120408				●	●	●	●		●		●			0.8	12.7	4.76	5.16		
		SNMA120412				●	●	●	●		●		●			1.2	12.7	4.76	5.16		
		SNMA120416				●	●	●								1.6	12.7	4.76	5.16		
				SNMA120416																	
		SNGA090304									●					0.4	9.525	3.18	3.81		
		SNGA120404							●		●			●	▲	0.4	12.7	4.76	5.16		
		SNGA120408								●		●		●	●	▲	0.8	12.7	4.76	5.16	
		SNGA120412									●		●		●	●	▲	1.2	12.7	4.76	5.16
		SNGA120416											●		●	●	▲	1.6	12.7	4.76	5.16

- : Line up
- ▲ : To be discontinued

Chip control range

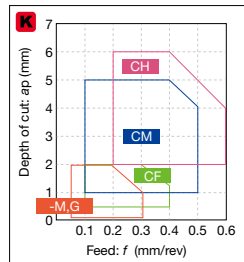
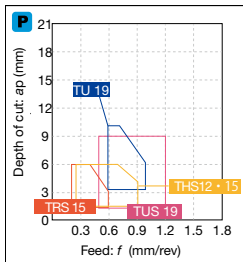

Reference pages: External toolholder → C101 -, Cartridge → K181 -

Insert NEGATIVE TYPE

- : Continuous cutting
- ◐ : Light interrupted cutting
- * : Heavy interrupted cutting

TN



	P Steel	M Stainless	K Cast iron	N Non-ferrous	S Superalloy	H Hard material
●	●	●	●	●	●	●
◐	◐	◐	◐	◐	◐	◐
*	*					

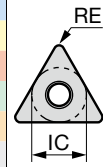

Application	Chipbreaker	Designation	Coated			Coated cermet		Cermet		Uncoated	Dimension (mm)					
			T9205	T9215	T9225	T9235	T6215	AH8015	AH6225	AH120	GT9530	AT9530	NS9530	NS520	TH10	RE
Finishing	TF	TNMG110402E-TF	●	●		●	●	●			0.2	6.35	4.76	2.26		
		TNMG110404E-TF	●	●		●	●	●			0.4	6.35	4.76	2.26		
		TNMG110408E-TF	●	●		●	●	●			0.8	6.35	4.76	2.26		
		TNMG160404-TF	●	●		●	●	●		●	0.4	9.525	4.76	3.81		
		TNMG160408-TF	●	●		●	●	●		●	0.8	9.525	4.76	3.81		
		TNMG160408-TF	●	●		●	●	●		●	0.8	9.525	4.76	3.81		
	TSF	TNMG110402E-TSF	●	●		●	●		●		0.2	6.35	4.76	2.26		
		TNMG110404E-TSF	●	●		●	●		●	●	0.4	6.35	4.76	2.26		
		TNMG110408E-TSF	●	●		●	●		●	●	0.8	6.35	4.76	2.26		
		TNMG160402-TSF	●	●		●	●	●		●	0.2	9.525	4.76	3.81		
		TNMG160404-TSF	●	●		●	●	●		●	0.4	9.525	4.76	3.81		
		TNMG160408-TSF	●	●		●	●	●		●	0.8	9.525	4.76	3.81		
	PS	TNMG110402E-PS	●	●		●	●		●		0.2	6.35	4.76	2.26		
		TNMG110404E-PS	●	●		●	●		●	●	0.4	6.35	4.76	2.26		
		TNMG110408E-PS	●	●		●	●		●	●	0.8	6.35	4.76	2.26		
		TNMG160402-PS	●	●		●	●	●		●	0.2	9.525	4.76	3.81		
		TNMG160404-PS	●	●		●	●	●		●	0.4	9.525	4.76	3.81		
		TNMG160408-PS	●	●		●	●	●		●	0.8	9.525	4.76	3.81		
Finishing for mild steel	ZF	TNMG160402-ZF	●	●		●	●		●		0.2	9.525	4.76	3.81		
		TNMG160404-ZF	●	●		●	●		●	●	0.4	9.525	4.76	3.81		
		TNMG160408-ZF	●	●		●	●		●	●	0.8	9.525	4.76	3.81		
		TNMG160412-ZF	●	●		●	●		●	●	1.2	9.525	4.76	3.81		
Finishing	AS	TNMG160404-AS			●	●			●		0.4	9.525	4.76	3.81		
		TNMG160408-AS	●	●	●	●			●		0.8	9.525	4.76	3.81		
		TNMG160412-AS	●	●	●					●		1.2	9.525	4.76	3.81	
	NS	TNMG160404-NS		●	●					●		0.4	9.525	4.76	3.81	
		TNMG160408-NS	●	●	●					●		0.8	9.525	4.76	3.81	
		TNMG160412-NS								●						

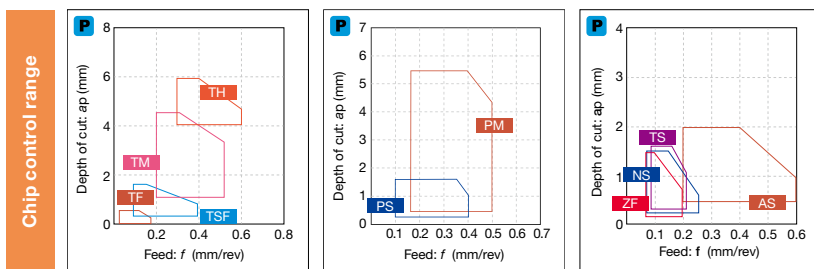

Reference pages: External toolholder → **C032** - Internal toolholder → **D049** -
 J-Series toolholder → **G051** - Cartridge → **K181** -

Grade

Insert

Ext. Toolholder

Int. Toolholder

Threading

Grooving

Miniature tool

Milling cutter

Endmill

Drilling tool

Tooling System

User's Guide

Index

Insert NEGATIVE TYPE



● : Continuous cutting
 ● : Light interrupted cutting
 * : Heavy interrupted cutting

TN

 **Triangular with hole**

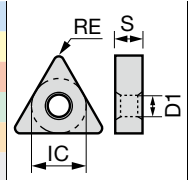
	P	M	K	N	S	H												
Steel	●	●	●	●	●	●	●	●	●	●	●	●	●	●	●	●	●	●
Stainless	●	●	●	●	●	●	●	●	●	●	●	●	●	●	●	●	●	●
Cast iron	●	●	●	●	●	●	●	●	●	●	●	●	●	●	●	●	●	●
Non-ferrous	●	●	●	●	●	●	●	●	●	●	●	●	●	●	●	●	●	●
Superalloy	●	●	●	●	●	●	●	●	●	●	●	●	●	●	●	●	●	●
Hard material	●	●	●	●	●	●	●	●	●	●	●	●	●	●	●	●	●	●

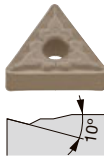
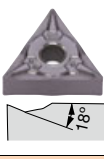

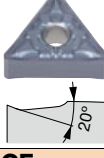
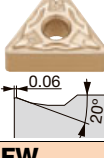
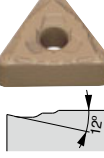
Application	Chipbreaker	Designation	Coated														Coated cermet		Cermet		Uncoated	Dimension (mm)			
			T9205	T9215	T9225	T9235	T6215	T5105	T5115	AH8005	AH8015	AH6225	AH6235	AH120	GH330	GT9530	AT9530	NS9530	NS520	KS20	RE	IC	S	D1	
Application	TS 	TNMG160404-TS	●	●	●	●	●			●	●					●	●				0.4	9.525	4.76	3.81	
		TNMG160408-TS	●	●	●	●	●			●	●					●	●				0.8	9.525	4.76	3.81	
		TNMG160412-TS	●	●	●	●	●			●	●							●			1.2	9.525	4.76	3.81	
	SF 	TNMG160404-SF					●				●										0.4	9.525	4.76	3.81	
		TNMG160408-SF					●				●										0.8	9.525	4.76	3.81	
		TNMG160412-SF					●				●										1.2	9.525	4.76	3.81	
	Finishing	SS 	TNMG110404E-SS									●	●								0.4	6.35	4.76	2.26	
			TNMG110408E-SS									●	●								0.8	6.35	4.76	2.26	
			TNMG160404-SS					●				●	●	●	●					●	0.4	9.525	4.76	3.81	
TNMG160408-SS							●				●	●	●	●					●	0.8	9.525	4.76	3.81		
TNMG160412-SS							●				●	●	●	●						1.2	9.525	4.76	3.81		
TNMG220404-SS							●				●	●	●	●						0.4	12.7	4.76	5.16		
TNMG220408-SS							●				●	●	●	●						0.8	12.7	4.76	5.16		
TNMG220412-SS						●				●	●	●	●						1.2	12.7	4.76	5.16			
HRF 	TNMG160404-HRF							●	●										0.4	9.525	4.76	3.81			
	TNMG160408-HRF							●	●										0.8	9.525	4.76	3.81			
CF 	TNMG160404-CF					●	●												0.4	9.525	4.76	3.81			
	TNMG160408-CF					●	●												0.8	9.525	4.76	3.81			
Finishing (wiper)	FW 	TNMG110404E-FW	●																0.4	6.35	4.76	2.26			
		TNMG110408E-FW	●																	0.8	6.35	4.76	2.26		
		TNMG160404-FW	●																	0.4	9.525	4.76	3.81		
		TNMG160408-FW	●																	0.8	9.525	4.76	3.81		

* Please see L011 - L015 about the adjustment of the machining program for rounding or taper machining by using SW/FW. ● : Line up
 Please contact our sales representatives if you have any question.

Insert NEGATIVE TYPE

- : Continuous cutting
- ◐ : Light interrupted cutting
- ⊠ : Heavy interrupted cutting

TN

 **Triangular with hole**

Material	Coated	Coated cemet	Cermet	Uncoated
P Steel	●◐⊠	●◐	●◐	●
M Stainless	●◐	●◐	●◐	●
K Cast iron	●◐	●◐	●◐	●
N Non-ferrous				●
S Superalloy	●			
H Hard material				

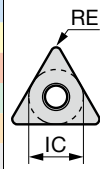

Application	Chipbreaker	Designation	Coated					Coated cemet	Cermet		Uncoated	Dimension (mm)			
			T9215	T9225	GH110	GH330	SH725	GT720	NS9530	NS520	TH10	RE	IC	S	D1
Finishing (sharp edge)	01	TNGG160402F-01				●						0.2	9.525	4.76	3.81
		TNGG160404F-01				●						0.4	9.525	4.76	3.81
		TNGG160408F-01				●						0.8	9.525	4.76	3.81
Finishing	01	TNGG110302-01						●				0.2	6.35	3.18	2.26
		TNGG110304-01						●				0.4	6.35	3.18	2.26
		TNGG110308-01						●	●			0.8	6.35	3.18	2.26
		TNGG160402-01			●			●	●	●		0.2	9.525	4.76	3.81
		TNGG160404-01			●			●	●		●	0.4	9.525	4.76	3.81
		TNGG160408-01			●			●	●			0.8	9.525	4.76	3.81
		TNGG160412-01					●		●			1.2	9.525	4.76	3.81
		TNMG110304-11						●				0.4	6.35	3.18	2.26
		TNMG110308-11						●				0.8	6.35	3.18	2.26
Finishing for mild steel	11	TNMG160402-11				●		●		●		0.2	9.525	4.76	3.81
		TNMG160404-11				●		●			●	0.4	9.525	4.76	3.81
		TNMG160408-11				●		●				0.8	9.525	4.76	3.81
		TNMG220404-11						●				0.4	12.7	4.76	5.16
		TNMG220408-11						●				0.8	12.7	4.76	5.16
		TNMG160404-17		●	●			●				0.4	9.525	4.76	3.81
		TNMG160408-17		●				●				0.8	9.525	4.76	3.81
Boring (double side)	CB	TNMG110304-CB	●					●				0.4	6.35	3.18	2.26
		TNMG110308-CB	●					●				0.8	6.35	3.18	2.26

● : Line up

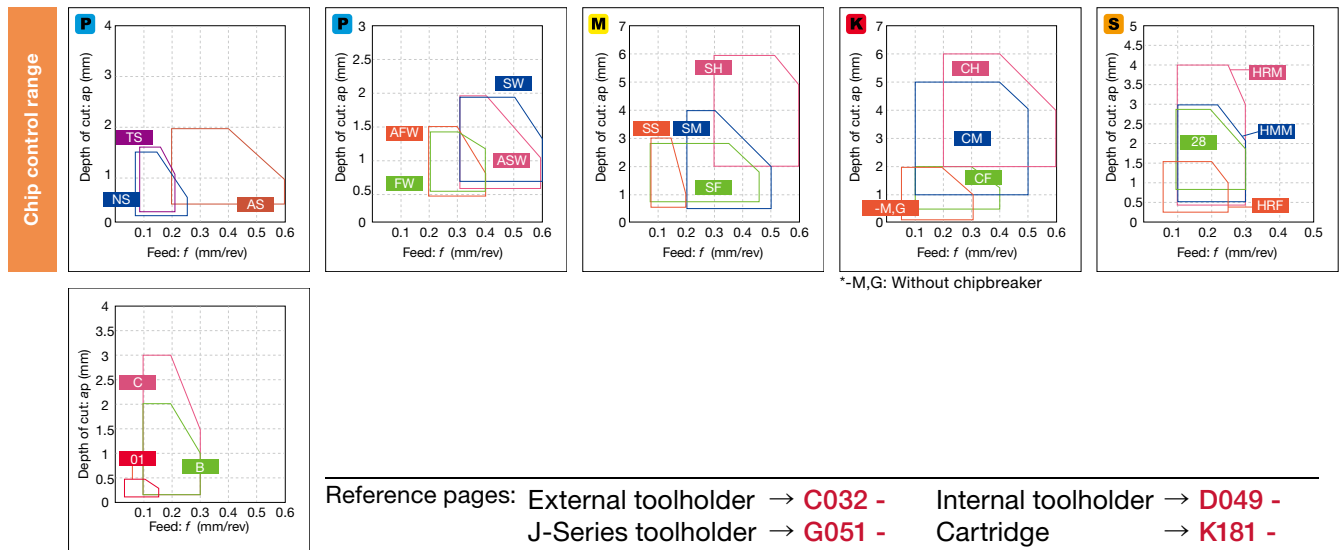

Grade: A
 Insert: B
 Ext. Toolholder: C
 Int. Toolholder: D
 Threading: E
 Grooving: F
 Miniature tool: G
 Milling cutter: H
 Endmill: I
 Drilling tool: J
 Tooling System: K
 User's Guide: L
 Index: M

Insert NEGATIVE TYPE

- : Continuous cutting
- ◐ : Light interrupted cutting
- ◑ : Heavy interrupted cutting

TN



Triangular with hole

Material	P Steel	M Stainless	K Cast iron	N Non-ferrous	S Superalloy	H Hard material	Coated	Coated cermet	Cermet	Others
P Steel	●	◐	◑	◐	◐	◐	●	●	●	●
M Stainless	◐	●	◐	◐	◐	◐	●	●	●	●
K Cast iron	◐	◐	●	◐	◐	◐	●	●	●	●
N Non-ferrous	◐	◐	◐	●	◐	◐	●	●	●	●
S Superalloy	◐	◐	◐	◐	●	◐	●	●	●	●
H Hard material	◐	◐	◐	◐	◐	●	●	●	●	●

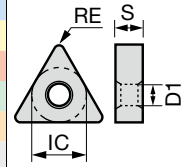

Application	Chipbreaker	Designation	Coated						Coated cermet	Cermet	Dimension (mm)				
			T9215	T9225	T9235	T6215	AH8015	AH6225	GT9530	NS9530	RE	IC	S	D1	
Medium cutting		PM TNMG110404E-PM	●	●	●	●	●				0.4	6.35	4.76	2.26	
		TNMG110408E-PM	●	●	●	●	●				0.8	6.35	4.76	2.26	
		TNMG110412E-PM	●	●	●	●	●				1.2	6.35	4.76	2.26	
		TNMG160404-PM	●	●	●	●	●				0.4	9.525	4.76	3.81	
		TNMG160408-PM	●	●	●	●	●				0.8	9.525	4.76	3.81	
		TNMG160412-PM	●	●	●	●	●				1.2	9.525	4.76	3.81	
		TNMG160416-PM	●	●	●	●	●				1.6	9.525	4.76	3.81	
Medium cutting for mild steel		ZM TNMG160404-ZM	●	●	●	●	●	●	●		0.4	9.525	4.76	3.81	
		TNMG160408-ZM	●	●	●	●	●	●	●	●	0.8	9.525	4.76	3.81	
		TNMG160412-ZM	●	●	●	●	●	●	●	●	1.2	9.525	4.76	3.81	
		TNMG160416-ZM	●	●	●	●	●	●	●	●	1.6	9.525	4.76	3.81	
		TNMG220412-ZM	●								1.2	12.7	4.76	5.16	
Medium cutting		AM TNMG160408-AM	●	●							0.8	9.525	4.76	3.81	
		TNMG160412-AM	●	●							1.2	9.525	4.76	3.81	
		NM TNMG160408-NM		●								0.8	9.525	4.76	3.81
		TNMG160412-NM	●	●								1.2	9.525	4.76	3.81

● : Line up

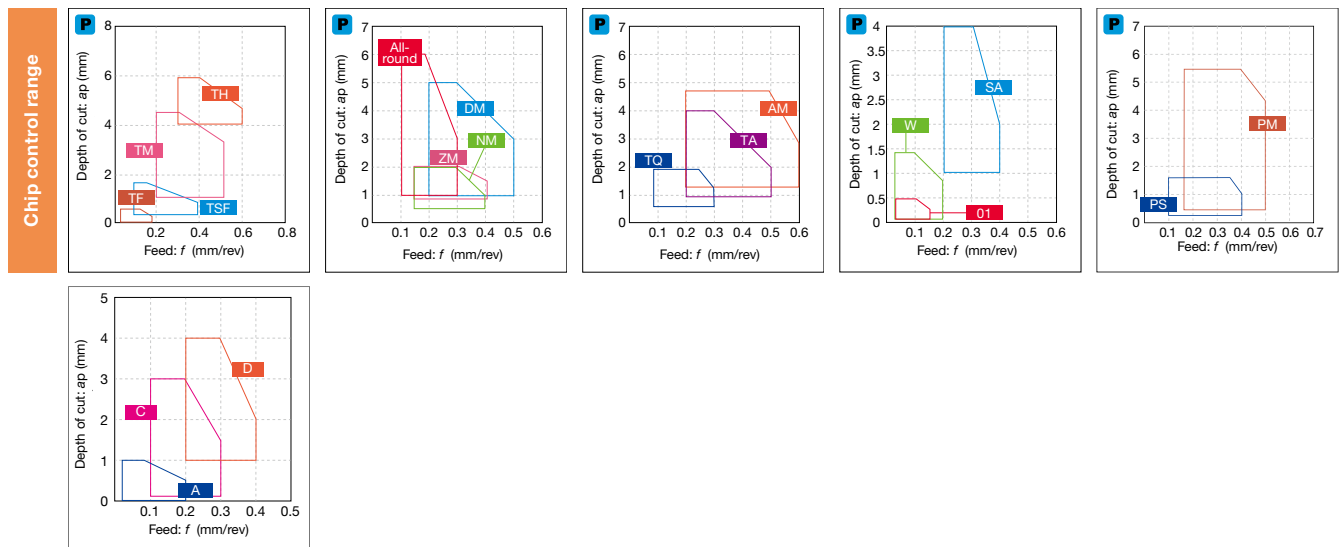

Reference pages: External toolholder → **C032** - Internal toolholder → **D049** -
 J-Series toolholder → **G051** - Cartridge → **K181** -

Insert NEGATIVE TYPE

● : Continuous cutting
 ● : Light interrupted cutting
 ✱ : Heavy interrupted cutting

TN

Triangular with hole

Material	Steel	Stainless	Cast iron	Non-ferrous	Superalloy	Hard material
P	●●●✱	●●	●●	●●	●●	●●
M	●●	●●●✱	●●	●●	●●	●●
K	●●	●●	●●	●●	●●	●●
N	●●	●●	●●	●●	●●	●●
S	●●	●●	●●	●●	●●	●●
H	●●	●●	●●	●●	●●	●●

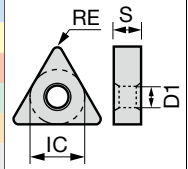

Application	Chipbreaker	Designation	Coated						Coated cermet		Cermet	Uncoated	Dimension (mm)				
			T9215	T9225	T6215	AH6225	AH6235	AH905	AH120	GT9530	AT9530	NS9530	KS20	RE	IC	S	D1
Medium cutting (wiper)	SW	TNMG110408E-SW	●											0.8	6.35	4.76	2.26
		TNMG110412E-SW	●											1.2	6.35	4.76	2.26
		TNMG160408-SW	●											0.8	9.525	4.76	3.81
		TNMG160412-SW	●											1.2	9.525	4.76	3.81
		*Wiper															
Medium cutting	TQ	TNMG160404-TQ	●●						●●	●●	●						
		TNMG160408-TQ	●●						●●	●●	●						
	TA	TNMG160404-TA	●●											0.4	9.525	4.76	3.81
		TNMG160408-TA	●●											0.8	9.525	4.76	3.81
		TNMG160412-TA	●●											1.2	9.525	4.76	3.81
	SA	TNMG160404-SA		●●●	●							●		0.4	9.525	4.76	3.81
		TNMG160408-SA		●●●	●							●		0.8	9.525	4.76	3.81
		TNMG160412-SA		●●●	●							●		1.2	9.525	4.76	3.81
		TNMG220408-SA		●●●	●							●		0.8	12.7	4.76	5.16
		TNMG220412-SA		●●●	●									1.2	12.7	4.76	5.16
	HMM	TNMG160404-HMM					●							0.4	9.525	4.76	3.81
		TNMG160408-HMM					●							0.8	9.525	4.76	3.81
	TNMG160412-HMM					●							1.2	9.525	4.76	3.81	

* Please see L011 - L015 about the adjustment of the machining program for rounding or taper machining by using SW/FW. ● : Line up
 Please contact our sales representatives if you have any question.

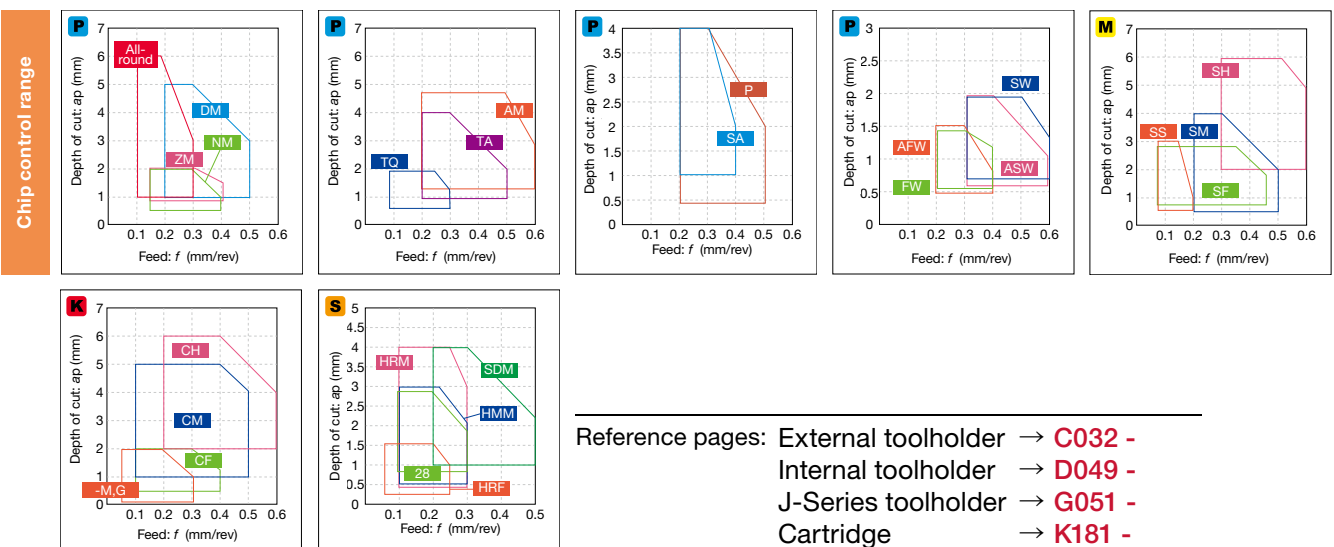

*-M,G: Without chipbreaker

Reference pages: External toolholder → C032 -
 Internal toolholder → D049 -
 J-Series toolholder → G051 -
 Cartridge → K181 -

Grade
Insert
Ext. Toolholder
Int. Toolholder
Threading
Grooving
Miniature tool
Milling cutter
Endmill
Drilling tool
Tooling System
User's Guide
Index



Insert NEGATIVE TYPE

● : Continuous cutting
 ● : Light interrupted cutting
 ✱ : Heavy interrupted cutting

TN



Triangular with hole

P	Steel								●	●	●	●											
M	Stainless								●	●	●	●											
K	Cast iron	●	●	●	●	●	●	●	●	●	●	●	●	●	●								
N	Non-ferrous																						
S	Superalloy																						
H	Hard material																						

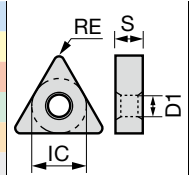

Application	Chipbreaker	Designation	Coated		Coated cermet	Cermet	Uncoated		Ceramic				Dimension (mm)							
			T505	T515	T5105	T5115	T5125	GH110	GT720	NS520	TH03	TH10	FX105	LX10	LX11	LX21	RE	IC	S	D1
			-	TNMA110404E	●														0.4	6.35
	TNMA110408E	●														0.8	6.35	4.76	2.26	
	TNMA110412E	●														1.2	6.35	4.76	2.26	
	TNMA160404	●	●	●	●				●	●						0.4	9.525	4.76	3.81	
	TNMA160408	●	●	●	●	●	●				●					0.8	9.525	4.76	3.81	
	TNMA160412	●	●	●	●	●					●					1.2	9.525	4.76	3.81	
	TNMA160416			●	●	●										1.6	9.525	4.76	3.81	
	TNMA160420			●	●	●										2	9.525	4.76	3.81	
	TNMA220404			●	●	●										0.4	12.7	4.76	5.16	
	TNMA220408			●	●	●										0.8	12.7	4.76	5.16	
	TNMA220412			●	●	●										1.2	12.7	4.76	5.16	
	TNMA220416			●	●	●										1.6	12.7	4.76	5.16	
	-	TNGA110304								●	●						0.4	6.35	3.18	2.26
		TNGA110308									●						0.8	6.35	3.18	2.26
		TNGA160304									●						0.4	9.525	3.18	3.81
		TNGA160308									●						0.8	9.525	3.18	3.81
	TNGA160402										●	▲				0.2	9.525	4.76	3.81	
	TNGA160404				●			●	●	●	●	●	▲	●		0.4	9.525	4.76	3.81	
	TNGA160408				●			●	●	●	●	●	▲	●		0.8	9.525	4.76	3.81	
	TNGA160412							●	●	●	●	●	▲	●		1.2	9.525	4.76	3.81	
	TNGA160416								●	●	●	●	▲	●		1.6	9.525	4.76	3.81	
	TNGA220408									●						0.8	12.7	4.76	5.16	

● : Line up
 ▲ : To be discontinued

Reference pages: External toolholder → C032 - Internal toolholder → D049 -
 TungCap → K013 -

Insert NEGATIVE TYPE

- : Continuous cutting
- ◐ : Light interrupted cutting
- ✱ : Heavy interrupted cutting

TN

 **Triangular without hole**

P	Steel	●
M	Stainless	●
K	Cast iron	● ● ●
N	Non-ferrous	●
S	Superalloy	●
H	Hard material	● ● ● ● ● ● ● ●

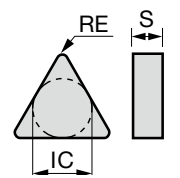

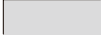
Application	Chipbreaker	Designation	Uncoated					Ceramic					Dimension (mm)				
			TH10	TZ120	FX105	LX10	LX11	LX21	RE	IC	S	D1					
Finishing to medium cutting	-	TNGN110308	●										0.8	6.35	3.18	-	
		TNGN160404				● ▲ ●							0.4	9.525	4.76	-	
		TNGN160408	●			● ▲ ●							0.8	9.525	4.76	-	
		TNGN160412	●	● ●	● ●	● ▲ ●	●						1.2	9.525	4.76	-	
		TNGN160416		● ●	● ●	● ▲							1.6	9.525	4.76	-	
		TNGN160420		●									2	9.525	4.76	-	
		TNGN160708					● ▲							0.8	9.525	7.94	-
		TNGN160712					▲							1.2	9.525	7.94	-

- : Line up
- ▲ : To be discontinued

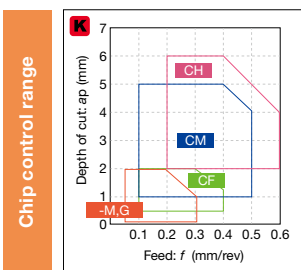

*-M,G: Without chipbreaker

Reference pages: Cartridge → **K193** -

- Grade **A**
- Insert **B**
- Toolholder **C**
- Toolholder **D**
- Threading **E**
- Grooving **F**
- Miniature tool **G**
- Milling cutter **H**
- Endmill **I**
- Drilling tool **J**
- Tooling System **K**
- User's Guide **L**
- Index **M**

Insert NEGATIVE TYPE

● : Continuous cutting
● : Light interrupted cutting
✳ : Heavy interrupted cutting

VN

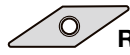

**Rhombic, 35°
with hole**

	P	M	K	N	S	H															
Steel	●	●●	●●	●●	●	●	●	●	●	●	●	●	●	●	●	●	●	●	●	●	●
Stainless	●	●●	●	●	●	●	●	●	●	●	●	●	●	●	●	●	●	●	●	●	●
Cast iron	●●	●●	●	●	●	●	●	●	●	●	●	●	●	●	●	●	●	●	●	●	●
Non-ferrous	●	●	●	●	●	●	●	●	●	●	●	●	●	●	●	●	●	●	●	●	●
Superalloy	●	●	●	●	●	●	●	●	●	●	●	●	●	●	●	●	●	●	●	●	●
Hard material	●	●	●	●	●	●	●	●	●	●	●	●	●	●	●	●	●	●	●	●	●

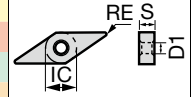

Application	Chipbreaker	Designation	Coated										Coated cermet		Cermet		Dimension (mm)					
			T9205	T9215	T9225	T9235	T6215	AH8005	AH8015	AH6225	AH6235	AH120	GH330	GT9530	GT720	AT9530	NS9530	NS520	RE	IC	S	D1
TF		VNMG120402E-TF	●	●	●	●	●	●	●	●	●	●				●		0.2	7.15	4.76	3.81	
		VNMG120404E-TF	●	●	●	●	●	●	●	●	●	●				●		0.4	7.15	4.76	3.81	
		VNMG120408E-TF	●	●	●	●	●	●	●	●	●	●				●		0.8	7.15	4.76	3.81	
		VNMG160404-TF	●	●	●	●	●	●	●	●	●	●				●		0.4	9.525	4.76	3.81	
		VNMG160408-TF	●	●	●	●	●	●	●	●	●	●		●		●		0.8	9.525	4.76	3.81	
TSF		VNMG120402E-TSF	●	●	●	●	●	●	●	●	●		●	●	●	●		0.2	7.15	4.76	3.81	
		VNMG120404E-TSF	●	●	●	●	●	●	●	●	●	●		●	●	●	●		0.4	7.15	4.76	3.81
		VNMG120408E-TSF	●	●	●	●	●	●	●	●	●	●		●	●	●	●		0.8	7.15	4.76	3.81
		VNMG160402-TSF	●	●	●	●	●	●	●	●	●	●		●	●	●	●		0.2	9.525	4.76	3.81
		VNMG160404-TSF	●	●	●	●	●	●	●	●	●	●		●	●	●	●		0.4	9.525	4.76	3.81
		VNMG160408-TSF	●	●	●	●	●	●	●	●	●	●		●	●	●	●		0.8	9.525	4.76	3.81
		VNMG160412-TSF	●	●	●	●	●	●	●	●	●	●							1.2	9.525	4.76	3.81
PS		VNMG120402E-PS	●	●	●	●	●	●	●	●	●				●		0.2	7.15	4.76	3.81		
		VNMG120404E-PS	●	●	●	●	●	●	●	●	●	●				●		0.4	7.15	4.76	3.81	
		VNMG120408E-PS	●	●	●	●	●	●	●	●	●	●				●		0.8	7.15	4.76	3.81	
		VNMG160402-PS	●	●	●	●	●	●	●	●	●	●				●		0.2	9.525	4.76	3.81	
		VNMG160404-PS	●	●	●	●	●	●	●	●	●	●				●		0.4	9.525	4.76	3.81	
		VNMG160408-PS	●	●	●	●	●	●	●	●	●	●				●		0.8	9.525	4.76	3.81	
		VNMG160412-PS	●	●	●	●	●	●	●	●	●	●				●		1.2	9.525	4.76	3.81	
ZF		VNMG120404E-ZF	●	●	●	●	●	●	●	●	●				●		0.4	7.15	4.76	3.81		
		VNMG120408E-ZF	●	●	●	●	●	●	●	●	●	●				●		0.8	7.15	4.76	3.81	
		VNMG160402-ZF	●	●	●	●	●	●	●	●	●	●				●		0.25	9.525	4.76	3.81	
		VNMG160404-ZF	●	●	●	●	●	●	●	●	●	●		●	●	●		0.4	9.525	4.76	3.81	
		VNMG160408-ZF	●	●	●	●	●	●	●	●	●	●		●	●	●		0.8	9.525	4.76	3.81	
VNMG160412-ZF	●	●	●	●	●	●	●	●	●	●				●		1.2	9.525	4.76	3.81			
TS		VNMG160404-TS	●	●	●	●	●	●	●	●	●		●	●	●	●		0.4	9.525	4.76	3.81	
		VNMG160408-TS	●	●	●	●	●	●	●	●	●	●		●	●	●	●		0.8	9.525	4.76	3.81
		VNMG160412-TS	●	●	●	●	●	●	●	●	●	●				●		1.2	9.525	4.76	3.81	
SF		VNMG160404-SF					●				●							0.4	9.525	4.76	3.81	
		VNMG160408-SF					●					●							0.8	9.525	4.76	3.81
SS		VNMG120404E-SS					●				●	●						0.4	7.15	4.76	3.81	
		VNMG120408E-SS					●					●	●						0.8	7.15	4.76	3.81
		VNMG160404-SS					●					●	●	●	●				0.4	9.525	4.76	3.81
		VNMG160408-SS					●					●	●	●	●				0.8	9.525	4.76	3.81
		VNMG160412-SS					●					●	●	●	●				1.2	9.525	4.76	3.81
HRF		VNMG160404-HRF						●	●									0.4	9.525	4.76	3.81	
		VNMG160408-HRF						●	●										0.8	9.525	4.76	3.81

● : Line up

Reference pages: External toolholder → **C041** - Internal toolholder → **D074** -
TungCap → **C042** -, **K014** -

Insert NEGATIVE TYPE

- : Continuous cutting
- ◐ : Light interrupted cutting
- ✱ : Heavy interrupted cutting

VN



Rhombic, 35°
with hole

Material	P Steel	M Stainless	K Cast iron	N Non-ferrous	S Superalloy	H Hard material	Coated	Coated cermet	Cermet	Uncoated
●	●	●	●	●	●	●	●	●	●	●
◐	◐	◐	◐	◐	◐	◐	◐	◐	◐	◐
✱	✱	✱	✱	✱	✱	✱	✱	✱	✱	✱

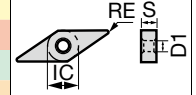

Application	Chipbreaker	Designation	Coated							Coated cermet	Cermet		Uncoated	Dimension (mm)								
			T9205	T9215	T9225	T9235	T6215	T5105	T5115	AH8015	AH6225	AH110	AH120	GH110	GH330	GT9530	NS9530	NS520	TH10	RE	IC	S
Finishing	CF	VNMG160404-CF																	0.4	9.525	4.76	3.81
		VNMG160408-CF																	0.8	9.525	4.76	3.81
	01	VNGG160402-01																	0.2	9.525	4.76	3.81
		VNGG160404-01																	0.4	9.525	4.76	3.81
		VNGG160408-01																	0.8	9.525	4.76	3.81
	11	VNMG160404-11																	0.4	9.525	4.76	3.81
VNMG160408-11																		0.8	9.525	4.76	3.81	
VNMG160412-11																		1.2	9.525	4.76	3.81	
Medium cutting	TM	VNMG120404E-TM	●	●	●			●	●									0.4	7.15	4.76	3.81	
		VNMG120408E-TM	●	●	●			●	●										0.8	7.15	4.76	3.81
		VNMG120412E-TM	●	●	●			●	●										1.2	7.15	4.76	3.81
		VNMG160404-TM	●	●	●	●		●	●			●							0.4	9.525	4.76	3.81
		VNMG160408-TM	●	●	●	●		●	●			●	●						0.8	9.525	4.76	3.81
		VNMG160412-TM	●	●	●	●		●	●			●	●						1.2	9.525	4.76	3.81
	PM	VNMG120404E-PM	●	●	●			●	●										0.4	7.15	4.76	3.81
		VNMG120408E-PM	●	●	●			●	●										0.8	7.15	4.76	3.81
		VNMG120412E-PM	●	●	●			●	●										1.2	7.15	4.76	3.81
		VNMG160404-PM	●	●	●			●	●			●							0.4	9.525	4.76	3.81
		VNMG160408-PM	●	●	●			●	●			●	●						0.8	9.525	4.76	3.81
		VNMG160412-PM	●	●	●			●	●			●	●						1.2	9.525	4.76	3.81
Medium cutting for mild steel	ZM	VNMG120408E-ZM	●	●	●			●	●									0.8	7.15	4.76	3.81	
		VNMG120412E-ZM	●	●	●			●	●										1.2	7.15	4.76	3.81
		VNMG160404-ZM	●	●	●			●	●			●							0.4	9.525	4.76	3.81
		VNMG160408-ZM	●	●	●			●	●			●	●						0.8	9.525	4.76	3.81
		VNMG160412-ZM	●	●	●			●	●									1.2	9.525	4.76	3.81	

● : Line up

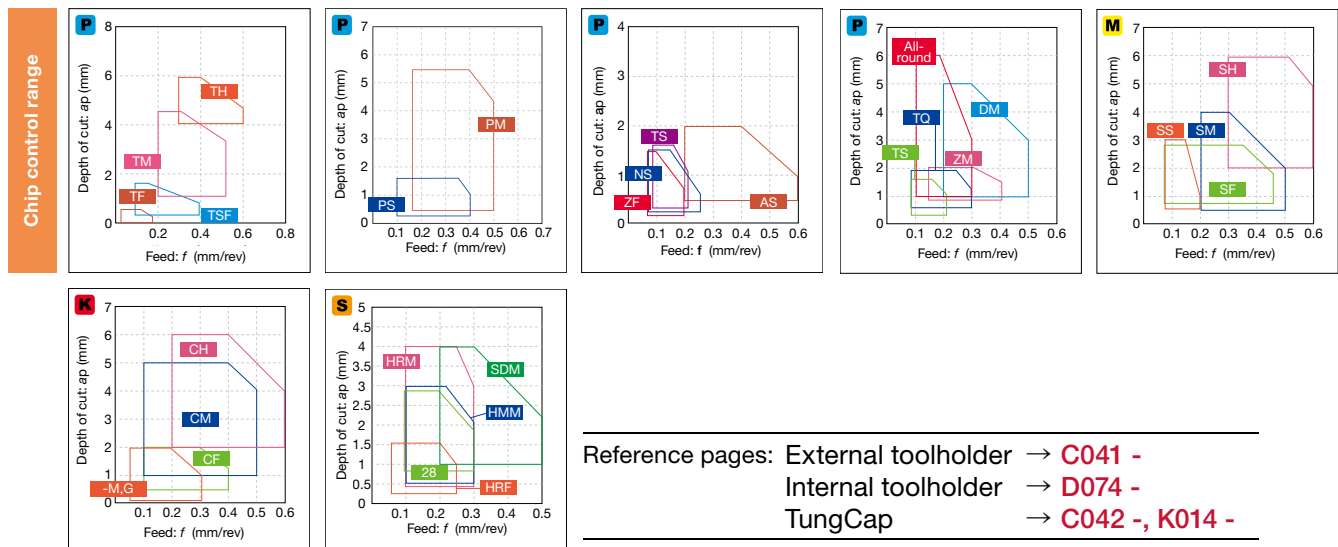

*-M,G: Without chipbreaker

Reference pages: External toolholder → **C041 -**
 Internal toolholder → **D074 -**
 TungCap → **C042 -, K014 -**



Negative

Positive

CBN

PCD

C

D

F

G

R

S

T

V

W

Y

OTHERS

Insert NEGATIVE TYPE

- : Continuous cutting
- ◐ : Light interrupted cutting
- * : Heavy interrupted cutting

VN

**Rhombic, 35°
with hole**

P	Steel	●	●	●	●	*	●												
M	Stainless		●	●			●			●	●	*							
K	Cast iron	●	●	●			●	●	●	●	*								
N	Non-ferrous																		
S	Superalloy										●	●							
H	Hard material																		

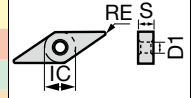

Application	Chipbreaker	Designation	Coated													Coated cermet	Cermet	Un-coated	Dimension (mm)								
			T9205	T9215	T9225	T9235	T6215	T505	T515	T5105	T5115	T5125	AH8005	AH8015	AH6225	AH6235	AH905	AH110	AH120	GT9530	AT9530	NS9530	TH10	RE	IC	S	D1
Medium cutting		DM VNMG160404-DM	●	●		●							●	●										0.8	9.525	4.76	3.81
		VNMG160408-DM	●	●	●	●	●						●	●										0.8	9.525	4.76	3.81
		VNMG160412-DM	●	●	●	●	●							●	●									1.2	9.525	4.76	3.81
Medium cutting		All-round VNMG160404	●	●	●	●	●	●	●	●	●	●					●	●					0.4	9.525	4.76	3.81	
		VNMG160408	●	●	●	●	●	●	●	●	●	●					●	●					0.8	9.525	4.76	3.81	
		VNMG160412		●	●		●	●	●	●	●	●					●						1.2	9.525	4.76	3.81	
Medium cutting		SM VNMG120404E-SM					●							●	●								0.4	7.15	4.76	3.81	
		VNMG120408E-SM					●							●	●								0.8	7.15	4.76	3.81	
		VNMG160404-SM					●							●	●								0.4	9.525	4.76	3.81	
Medium cutting		VNMG160408-SM					●							●	●								0.8	9.525	4.76	3.81	
		VNMG160412-SM					●							●	●								1.2	9.525	4.76	3.81	
	Medium cutting		SDM VNMG160404-SDM					●								●	●							0.4	9.525	4.76	3.81
		VNMG160408-SDM					●								●	●							0.8	9.525	4.76	3.81	
		VNMG160412-SDM					●								●	●							1.2	9.525	4.76	3.81	
Medium cutting		HRM VNMG160404-HRM											●	●									0.4	9.525	4.76	3.81	
		VNMG160408-HRM											●	●									0.8	9.525	4.76	3.81	
		VNMG160412-HRM											●	●									1.2	9.525	4.76	3.81	
Medium cutting		CM VNMG160408-CM						●	●	●	●	●											0.8	9.525	4.76	3.81	
		VNMG160412-CM								●	●	●											1.2	9.525	4.76	3.81	
Medium cutting		TQ VNMG160404-TQ	●	●														●	●				0.4	9.525	4.76	3.81	
		VNMG160408-TQ	●	●														●	●				0.8	9.525	4.76	3.81	
Medium cutting		HMM VNMG160404-HMM															●						0.4	9.525	4.76	3.81	
		VNMG160408-HMM															●						0.8	9.525	4.76	3.81	
		VNMG160412-HMM															●						1.2	9.525	4.76	3.81	

● : Line up

Reference pages: External toolholder → C041 - Internal toolholder → D074 -
TungCap → C042 -, K014 -

Insert NEGATIVE TYPE

● : Continuous cutting
 ● : Light interrupted cutting
 ✱ : Heavy interrupted cutting

VN

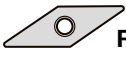

Rhombic, 35°
with hole

P Steel	●●●✱																			
M Stainless	●●						●	●	●●											
K Cast iron	●●	●●	●	●	✱		●	●	●●											
N Non-ferrous																				
S Superalloy							●	●	●●											
H Hard material																				

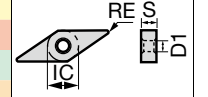

Application	Chipbreaker	Designation	Coated								Cermet	Uncoated	Ceramic		Dimension (mm)					
			T9215	T9225	T515	T5105	T5115	T5125	AH8005	AH8015			AH110	AH120	NS520	KS05F	TH10	LX10	LX11	RE
Medium cutting	28	VNMG160404-28											●				0.4	9.525	4.76	3.81
		VNMG160408-28											●				0.8	9.525	4.76	3.81
	33	VNMG160404-33	●											●			0.4	9.525	4.76	3.81
		VNMG160408-33	●	●										●			0.8	9.525	4.76	3.81
Finishing to medium cutting	-	VNMA120404E		●													0.4	7.15	4.76	3.81
		VNMA120408E		●													0.8	7.15	4.76	3.81
		VNMA160402												●			0.2	9.525	4.76	3.81
		VNMA160404			●	●	●					●		●			0.4	9.525	4.76	3.81
		VNMA160408			●	●	●					●		●			0.8	9.525	4.76	3.81
		VNGA160404													●	▲	0.4	9.525	4.76	3.81
		VNGA160408													●	▲	0.8	9.525	4.76	3.81

● : Line up
 ▲ : To be discontinued

VN

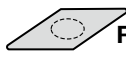

Rhombic, 35°
without hole

P Steel																				
M Stainless																				
K Cast iron	●●																			
N Non-ferrous																				
S Superalloy																				
H Hard material																				

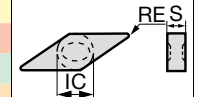

Application	Chipbreaker	Designation	Ceramic	Dimension (mm)			
				RE	IC	S	D1
Finishing to medium cutting	-	VNGD160712	●	1.2	9.525	4.76	-

● : Line up

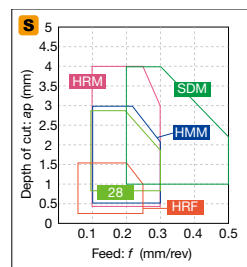
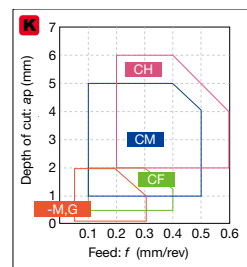
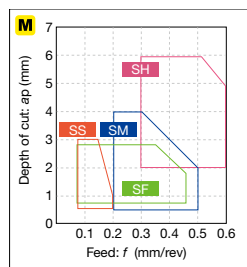
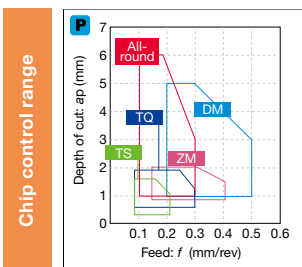

*-M,G: Without chipbreaker

Reference pages: VNMG..., VNMA..., VNGA...:

External toolholder → C041 -, Internal toolholder → D074 -

TungCap → C042 -, K014 -

VNGD...: External toolholder → C051

Grade
 Insert
 Ext. Toolholder
 Int. Toolholder
 Threading
 Grooving
 Miniature cutter
 Milling cutter
 Endmill
 Drilling tool
 Tooling System
 User's Guide
 Index



Insert NEGATIVE TYPE

WN



**Trigon, 80°
with hole**

P	Steel	●	◐	◐	◐	✱	◐	◐	●	◐	◐	◐	◐	◐	◐	◐	◐	◐	◐	◐	◐
M	Stainless	●	◐	◐						◐	◐	◐	◐	◐	◐	◐	◐	◐	◐	◐	◐
K	Cast iron	◐	◐	◐			◐		◐	◐	◐	◐	◐	◐	◐	◐	◐	◐	◐	◐	◐
N	Non-ferrous								◐												
S	Superalloy									◐											
H	Hard material																				

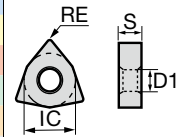

Application	Chipbreaker	Designation	Coated								Coated cermet		Cermet	Dimension (mm)				
			T9205	T9215	T9225	T9235	T6215	T515	AH8015	AH6225	AH120	GT9530	AT9530	NS9530	RE	IC	S	D1
Application		TF WNMG060402E-TF	●	●		●		●	●				●	0.2	9.525	4.76	3.81	
		WNMG060404E-TF	●	●		●		●	●				●	0.4	9.525	4.76	3.81	
		WNMG060408E-TF	●	●		●		●	●				●	0.8	9.525	4.76	3.81	
		WNMG080404-TF	●	●		●		●	●				●	0.4	12.7	4.76	5.16	
		WNMG080408-TF	●	●		●		●	●				●	0.8	12.7	4.76	5.16	
Finishing		TSF WNMG060402E-TSF	●	●		●		●	●		●	●	●	0.2	9.525	4.76	3.81	
		WNMG060404E-TSF	●	●		●		●	●		●	●	●	0.4	9.525	4.76	3.81	
		WNMG060408E-TSF	●	●		●		●	●		●	●	●	0.8	9.525	4.76	3.81	
		WNMG060412E-TSF	●	●		●		●	●		●	●	●	1.2	9.525	4.76	3.81	
		WNMG060404-TSF	●	●		●		●	●					0.4	9.525	4.76	3.81	
		WNMG060408-TSF	●	●		●		●	●					0.8	9.525	4.76	3.81	
		WNMG080402-TSF	●	●		●		●	●				●	0.2	12.7	4.76	5.16	
		WNMG080404-TSF	●	●	●	●	●	●	●	●		●	●	●	0.4	12.7	4.76	5.16
		WNMG080408-TSF	●	●	●	●	●	●	●	●		●	●	●	0.8	12.7	4.76	5.16
		WNMG080412-TSF	●	●	●	●	●	●	●	●		●	●	●	1.2	12.7	4.76	5.16
Finishing		PS WNMG060402E-PS	●	●		●		●	●			●	0.2	9.525	4.76	3.81		
		WNMG060404E-PS	●	●		●		●	●			●	0.4	9.525	4.76	3.81		
		WNMG060408E-PS	●	●		●		●	●			●	0.8	9.525	4.76	3.81		
		WNMG080402-PS	●	●		●		●	●			●	0.2	12.7	4.76	5.16		
		WNMG080404-PS	●	●		●		●	●			●	0.4	12.7	4.76	5.16		
		WNMG080408-PS	●	●		●		●	●			●	0.8	12.7	4.76	5.16		
		WNMG080412-PS	●	●		●		●	●			●	1.2	12.7	4.76	5.16		
Finishing for mild steel		ZF WNMG060404E-ZF	●	●		●		●	●			●	0.4	9.525	4.76	3.81		
		WNMG060408E-ZF	●	●		●		●	●			●	0.8	9.525	4.76	3.81		
		WNMG060404-ZF	●	●		●		●	●					0.4	9.525	4.76	3.81	
		WNMG060408-ZF	●	●		●		●	●					0.8	9.525	4.76	3.81	
		WNMG080402-ZF	●	●		●		●	●			●	0.2	12.7	4.76	5.16		
		WNMG080404-ZF	●	●	●	●	●	●	●		●	●	●	0.4	12.7	4.76	5.16	
		WNMG080408-ZF	●	●	●	●	●	●	●		●	●	●	0.8	12.7	4.76	5.16	
		WNMG080412-ZF	●	●		●		●	●			●	●	1.2	12.7	4.76	5.16	
Finishing		AS WNMG080404-AS	●									●	0.4	12.7	4.76	5.16		
		WNMG080408-AS	●	●	●	●						●	0.8	12.7	4.76	5.16		
		WNMG080412-AS	●	●	●	●						●	1.2	12.7	4.76	5.16		
		NS WNMG080404-NS	●	●									●	0.4	12.7	4.76	5.16	
WNMG080408-NS	●	●									●	0.8	12.7	4.76	5.16			

● : Line up

Reference pages: External toolholder → **C024 -** Internal toolholder → **D031 -**
 TungCap → **C024 -, K010**

Insert NEGATIVE TYPE

- : Continuous cutting
- ◐ : Light interrupted cutting
- ✱ : Heavy interrupted cutting

WN



Trigon, 80°
with hole

	P	M	K	N	S	H
Steel	●	●	●	●	●	●
Stainless	●	●	●	●	●	●
Cast iron	●	●	●	●	●	●
Non-ferrous	●	●	●	●	●	●
Superalloy	●	●	●	●	●	●
Hard material	●	●	●	●	●	●

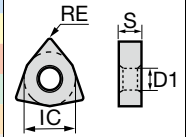

Application	Chipbreaker	Designation	Coated							Coated cermet		Cermet		Dimension (mm)					
			T9215	T9225	T9235	T6215	AH8005	AH8015	AH6225	AH6235	AH120	GH330	GT9530	AT9530	NS9530	NS520	RE	IC	S
Finishing	TS 	WNMG060402E-TS	●	●		●	●						●			0.2	9.525	4.76	3.81
		WNMG060404E-TS	●	●		●	●						●			0.4	9.525	4.76	3.81
		WNMG060408E-TS	●	●		●	●						●			0.8	9.525	4.76	3.81
		WNMG080404-TS	●	●	●		●	●				●	●			0.4	12.7	4.76	5.16
		WNMG080408-TS	●	●	●		●	●				●	●			0.8	12.7	4.76	5.16
		WNMG080412-TS	●	●	●		●	●						●		1.2	12.7	4.76	5.16
	SF 	WNMG060404-SF				●			●							0.4	9.525	4.76	3.81
		WNMG060408-SF				●			●							0.8	9.525	4.76	3.81
		WNMG080404-SF				●			●							0.4	12.7	4.76	5.16
		WNMG080408-SF				●			●							0.8	12.7	4.76	5.16
	SS 	WNMG060404E-SS							●	●						0.4	9.525	4.76	3.81
		WNMG060408E-SS							●	●						0.8	9.525	4.76	3.81
		WNMG060412E-SS							●	●						1.2	9.525	4.76	3.81
		WNMG080404-SS				●		●	●	●	●					0.4	12.7	4.76	5.16
		WNMG080408-SS				●		●	●	●	●					0.8	12.7	4.76	5.16
		WNMG080412-SS				●		●	●							1.2	12.7	4.76	5.16
HRF 	WNMG080404-HRF					●	●								0.4	12.7	4.76	5.16	
	WNMG080408-HRF					●	●								0.8	12.7	4.76	5.16	

● : Line up

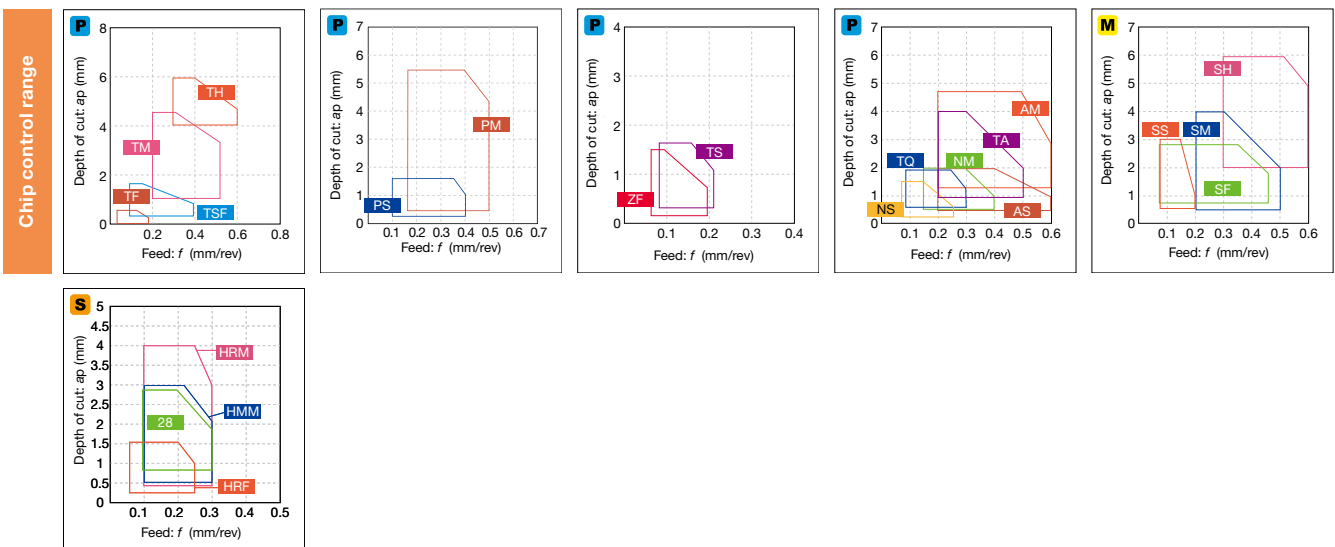

Reference pages: External toolholder → C024 - Internal toolholder → D031 -
TungCap → C024 -, K010

Insert NEGATIVE TYPE

- : Continuous cutting
- ◐ : Light interrupted cutting
- ✱ : Heavy interrupted cutting

WN



**Trigon, 80°
with hole**

Material	P	M	K	N	S	H	Coated	Coated cermet	Cermet
Steel	●	●	●	●	●	●	●	●	●
Stainless	●	●	●	●	●	●	●	●	●
Cast iron	●	●	●	●	●	●	●	●	●
Non-ferrous	●	●	●	●	●	●	●	●	●
Superalloy	●	●	●	●	●	●	●	●	●
Hard material	●	●	●	●	●	●	●	●	●

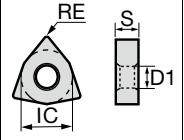

Application	Chipbreaker	Designation	Coated										Coated cermet	Cermet	Dimension (mm)			
			T9205	T9215	T9225	T9235	T6215	T515	AH8015	AH6225	AH6235	AH725	AH120	GT9530	NS9530	RE	IC	S
Medium cutting		TM WNMG060404E-TM	●	●	●	●	●	●	●	●	●	●			0.4	9.525	4.76	3.81
		WNMG060408E-TM	●	●	●	●	●	●	●	●	●	●			0.8	9.525	4.76	3.81
		WNMG060412E-TM	●	●	●	●	●	●	●	●	●	●			1.2	9.525	4.76	3.81
		WNMG060404-TM	●	●	●	●	●	●	●	●	●	●			0.4	9.525	4.76	3.81
		WNMG060408-TM	●	●	●	●	●	●	●	●	●	●			0.8	9.525	4.76	3.81
		WNMG080404-TM	●	●	●	●	●	●	●	●	●	●			0.4	12.7	4.76	5.16
		WNMG080408-TM	●	●	●	●	●	●	●	●	●	●			0.8	12.7	4.76	5.16
		WNMG080412-TM	●	●	●	●	●	●	●	●	●	●			1.2	12.7	4.76	5.16
	WNMG080416-TM	●	●	●	●	●	●	●	●	●	●			1.6	12.7	4.76	5.16	
		PM WNMG060404E-PM	●	●	●	●	●	●	●	●	●			0.4	9.525	4.76	3.81	
		WNMG060408E-PM	●	●	●	●	●	●	●	●	●			0.8	9.525	4.76	3.81	
		WNMG060412E-PM	●	●	●	●	●	●	●	●	●	●			1.2	9.525	4.76	3.81
		WNMG080404-PM	●	●	●	●	●	●	●	●	●	●			0.4	12.7	4.76	5.16
		WNMG080408-PM	●	●	●	●	●	●	●	●	●	●			0.8	12.7	4.76	5.16
WNMG080412-PM		●	●	●	●	●	●	●	●	●	●			1.2	12.7	4.76	5.16	
WNMG080416-PM		●	●	●	●	●	●	●	●	●	●			1.6	12.7	4.76	5.16	
Medium cutting for mild steel			ZM WNMG060408E-ZM	●	●	●	●	●	●	●	●	●			0.8	9.525	4.76	3.81
	WNMG060412E-ZM		●	●	●	●	●	●	●	●	●			1.2	9.525	4.76	3.81	
	WNMG060408-ZM		●	●	●	●	●	●	●	●	●	●			0.8	9.525	4.76	3.81
	WNMG060412-ZM		●	●	●	●	●	●	●	●	●	●			1.2	9.525	4.76	3.81
	WNMG080404-ZM		●	●	●	●	●	●	●	●	●	●			0.4	12.7	4.76	5.16
	WNMG080408-ZM		●	●	●	●	●	●	●	●	●	●	●	●	0.8	12.7	4.76	5.16
	WNMG080412-ZM		●	●	●	●	●	●	●	●	●	●	●	●	1.2	12.7	4.76	5.16
	WNMG080416-ZM		●	●	●	●	●	●	●	●	●	●	●	●	1.6	12.7	4.76	5.16

● : Line up

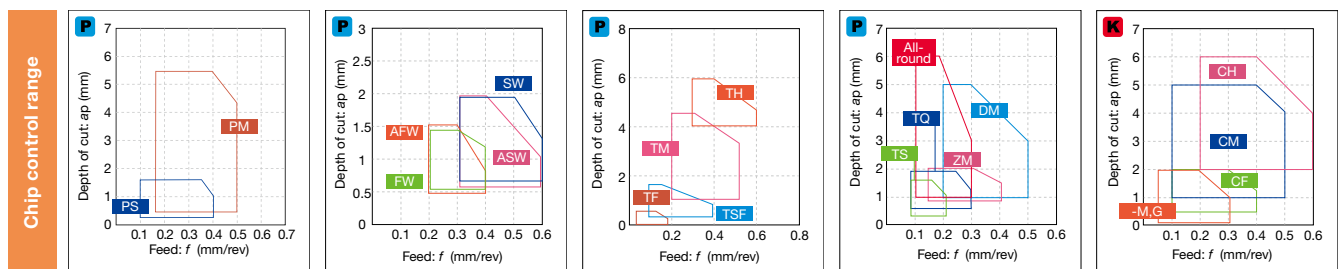

*-M,G: Without chipbreaker

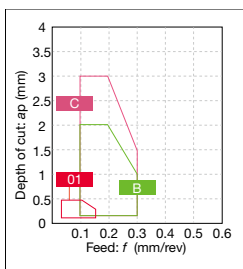

Reference pages: External toolholder → C024 - Internal toolholder → D031 -
TungCap → C024 -, K010

Grade
Insert
Ext. Toolholder
Int. Toolholder
Threading
Grooving
Miniature tool
Milling cutter
Endmill
Drilling tool
Tooling System
User's Guide
Index



Insert NEGATIVE TYPE

● : Continuous cutting
 ● : Light interrupted cutting
 ✱ : Heavy interrupted cutting

WN



Trigon, 80° with hole

P	Steel	●	●	●	●	●	●																	
M	Stainless		●	●																				
K	Cast iron	●	●	●	✱				●	●	●	●	✱								●	●	●	
N	Non-ferrous																							
S	Superalloy																							
H	Hard material																							

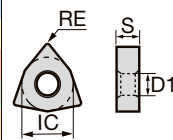

Application	Chipbreaker	Designation	Coated													Cermets		Uncoated	Dimension (mm)												
			T9205	T9215	T9225	T9235	T6215	T505	T515	T5105	T5115	T5125	AH8005	AH8015	AH6225	AH6235	AH725	AH110	AH120	NS9530	NS520	TH10	RE	IC	S	D1					
AM		WNUMG080408-AM	●	●																				0.8	12.7	4.76	5.16				
		WNUMG080412-AM	●	●																					1.2	12.7	4.76	5.16			
		WNUMG080416-AM	●	●																						1.6	12.7	4.76	5.16		
NM		WNUMG060412E-NM			●																				1.2	9.525	4.76	3.81			
		WNUMG080408-NM	●	●	●																					0.8	12.7	4.76	5.16		
		WNUMG080412-NM	●	●	●	●																					1.2	12.7	4.76	5.16	
DM		WNUMG080404-DM		●	●	●								●	●											0.4	12.7	4.76	5.16		
		WNUMG080408-DM	●	●	●	●								●	●												0.8	12.7	4.76	5.16	
		WNUMG080412-DM	●	●	●	●	●								●	●												1.2	12.7	4.76	5.16
		WNUMG080416-DM	●	●	●	●	●								●	●													1.6	12.7	4.76
All-round		WNUMG060404		●	●						●	●	●													0.4	9.525	4.76	3.81		
		WNUMG060408		●	●						●	●	●														0.8	9.525	4.76	3.81	
		WNUMG080404	●	●	●	●		●	●	●	●	●					●	●		●	●		●				0.4	12.7	4.76	5.16	
		WNUMG080408	●	●	●	●		●	●	●	●	●					●	●		●	●		●				0.8	12.7	4.76	5.16	
		WNUMG080412	●	●	●	●		●	●	●	●	●					●	●				●						1.2	12.7	4.76	5.16
		WNUMG080416	●	●	●	●		●	●	●	●	●					●	●				●							1.6	12.7	4.76
SM		WNUMG060404E-SM				●								●												0.4	9.525	4.76	3.81		
		WNUMG060408E-SM				●								●													0.8	9.525	4.76	3.81	
		WNUMG060412E-SM				●								●														1.2	9.525	4.76	3.81
		WNUMG060408-SM														●												0.8	9.525	4.76	3.81
		WNUMG080404-SM				●										●	●											0.4	12.7	4.76	5.16
		WNUMG080408-SM				●										●	●	●										0.8	12.7	4.76	5.16
SDM		WNUMG080404-SDM				●									●	●											0.4	12.7	4.76	5.16	
		WNUMG080408-SDM				●										●	●											0.8	12.7	4.76	5.16
		WNUMG080412-SDM				●										●	●											1.2	12.7	4.76	5.16
HRM		WNUMG080404-HRM													●	●											0.4	12.7	4.76	5.16	
		WNUMG080408-HRM														●	●											0.8	12.7	4.76	5.16
		WNUMG080412-HRM														●	●												1.2	12.7	4.76

● : Line up

Reference pages: External toolholder → C024 - Internal toolholder → D031 -
 TungCap → C024 -, K010

Insert NEGATIVE TYPE

- : Continuous cutting
- ◐ : Light interrupted cutting
- ✳ : Heavy interrupted cutting

WN



**Trigon, 80°
with hole**

	P	M	K	N	S	H	Coated	Coated cermet	Cermet	Uncoated
Steel	●	●	●	●	●	●	●	●	●	●
Stainless	●	●	●	●	●	●	●	●	●	●
Cast iron	●	●	●	●	●	●	●	●	●	●
Non-ferrous	●	●	●	●	●	●	●	●	●	●
Superalloy	●	●	●	●	●	●	●	●	●	●
Hard material	●	●	●	●	●	●	●	●	●	●

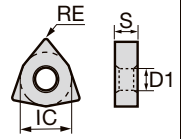

Application	Chipbreaker	Designation	Coated							Coated cermet	Cermet	Uncoated	Dimension (mm)									
			T9205	T9215	T9225	T9235	T6215	T515	AH8015	AH6225	AH6235	AH905	AH725	AH120	GH330	GT720	NS9530	TH10	KS20	RE	IC	S
Medium cutting	SA	WNMG080408-SA					●		●	●	●	●	●				●		0.8	12.7	4.76	5.16
		WNMG080412-SA					●		●	●		●							1.2	12.7	4.76	5.16
	HMM	WNMG080404-HMM											●						0.4	12.7	4.76	5.16
		WNMG080408-HMM											●						0.8	12.7	4.76	5.16
		WNMG080412-HMM											●						1.2	12.7	4.76	5.16
	27	WNMG080408-27		●															0.8	12.7	4.76	5.16
Medium to heavy cutting	TH	WNMG080408-TH	●	●	●	●	●	●	●				●						0.8	12.7	4.76	5.16
		WNMG080412-TH	●	●	●	●	●	●	●				●						1.2	12.7	4.76	5.16
	WNMG080416-TH	●	●	●			●	●				●							1.6	12.7	4.76	5.16
	WNMG100612-TH		●	●															1.2	15.875	6.35	6.35
	WNMG100616-TH		●	●															1.6	15.875	6.35	6.35
	THS	WNMG080408-THS	●	●	●	●													0.8	12.7	4.76	5.16
WNMG080412-THS	●	●	●	●														1.2	12.7	4.76	5.16	
WNMG080416-THS		●	●															1.6	12.7	4.76	5.16	
WNMG100612-THS		●	●	●														1.2	15.875	6.35	6.35	
WNMG100616-THS		●	●	●														1.6	15.875	6.35	6.35	

● : Line up

Reference pages: External toolholder → C024 - Internal toolholder → D031 -
TungCap → C024 -, K010

Insert NEGATIVE TYPE

- : Continuous cutting
- ◐ : Light interrupted cutting
- ◑ : Heavy interrupted cutting

WN



**Trigon, 80°
with hole**

Material	P	M	K	N	S	H	Coated	Cermet	Uncoated	Ceramic
Steel	●							●		
Stainless		●								
Cast iron	●	●	●	●	●			●		
Non-ferrous			●	●	●				●	
Superalloy										●
Hard material										●

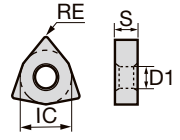

Application	Chipbreaker	Designation	Coated						Cermet	Uncoated	Ceramic		Dimension (mm)			
			T505	T515	T5105	T5115	T5125	AH6225	AH6235	NS520	TH10	LX10	LX11	RE	IC	S
Medium to heavy cutting	SH 	WNMG080408-SH					●	●					0.8	12.7	4.76	5.16
		WNMG080412-SH					●	●					1.2	12.7	4.76	5.16
	CH 	WNMG080408-CH		●	●	●							0.8	12.7	4.76	5.16
		WNMG080412-CH		●	●	●							1.2	12.7	4.76	5.16
Finishing to medium cutting		WNMA060404E	●										0.4	9.525	4.76	3.81
		WNMA060408E	●										0.8	9.525	4.76	3.81
		WNMA060412E	●										1.2	9.525	4.76	3.81
		WNMA060416E	●										1.6	9.525	4.76	3.81
		WNMA080404		●	●	●				●			0.4	12.7	4.76	5.16
		WNMA080408	●	●	●	●	●		●	●			0.8	12.7	4.76	5.16
		WNMA080412	●	●	●	●	●						1.2	12.7	4.76	5.16
		WNMA080416	●	●	●	●	●						1.6	12.7	4.76	5.16
		WNGA080404									●	▲	0.4	12.7	4.76	5.16
		WNGA080408									●	▲	0.8	12.7	4.76	5.16
WNGA080412									●	▲	1.2	12.7	4.76	5.16		

- : Line up
- ▲ : To be discontinued

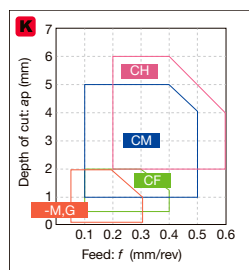
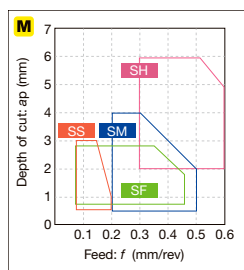
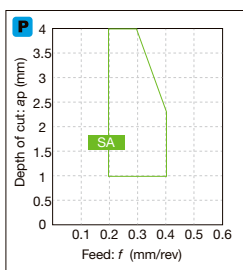
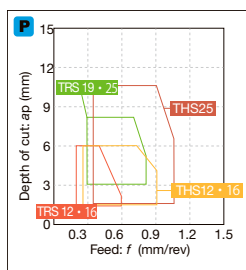
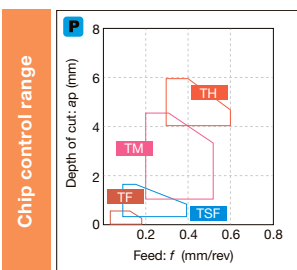

*-M,G: Without chipbreaker

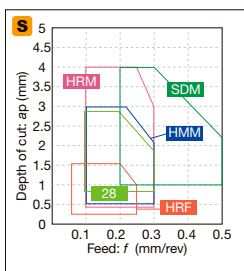

Reference pages: External toolholder → C024 - Internal toolholder → D031 - TungCap → C024 -, K010

Insert NEGATIVE TYPE

● : Continuous cutting
 ●• : Light interrupted cutting
 ✱ : Heavy interrupted cutting

YN

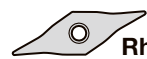
Rhombic, 25°
with hole

	P	M	K	N	S	H	1	2	3	4	5	6	7	8	9	10	11	12	13	14	15	16	17	18	19	20	21	22	23	24	25	
Steel	●•	●•	●•																													
Stainless	●•	●•																														
Cast iron	●•																															
Non-ferrous																																
Superalloy																																
Hard material																																



Application	Chipbreaker	Designation	Coated			Coated cermet	Cermet	Dimension (mm)						
			T9215	T9225	T9235	T6215	AH8015	AH6225	GT9530	NS9530	RE	IC	S	D1
Finishing for mild steel	ZF	YNMG160402-ZF	●	●	●	●	●	●	●	●	0.2	9.525	4.76	3.81
		YNMG160404-ZF	●	●	●	●	●	●	●	●	0.4	9.525	4.76	3.81
		YNMG160408-ZF	●	●	●	●	●	●	●	●	0.8	9.525	4.76	3.81
Medium cutting for mild steel	ZM	YNMG160404-ZM	●	●	●	●	●	●	●	●	0.4	9.525	4.76	3.81
		YNMG160408-ZM	●	●	●	●	●	●	●	●	0.8	9.525	4.76	3.81

● : Line up

KN

Parallelogram, 55°
without hole

	P	M	K	N	S	H	1	2	3	4	5	6	7	8	9	10	11	12	13	14	15	16	17	18	19	20	21	22	23	24	25
Steel	●•	●•	●•																												
Stainless	●•	●•																													
Cast iron	●•																														
Non-ferrous																															
Superalloy																															
Hard material																															

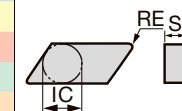

Application	Chipbreaker	Designation	Coated			Dimension (mm)								
			GH330				RE	IC	S	D1				
Finishing	S1	KNMX160405R-S1	●								0.5	9.525	4.76	-
		KNMX160405L-S1	●								0.5	9.525	4.76	-

● : Line up

Chip control range

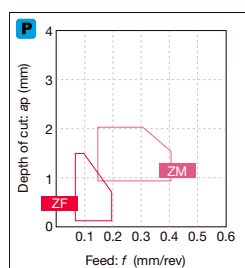

Reference pages: YNMG...: External toolholder → C041 -, Internal toolholder → D074 -
 TungCap → C042 -, K014 -

Insert NEGATIVE TYPE

- : Continuous cutting
- : Light interrupted cutting
- ⚙ : Heavy interrupted cutting

HN

Hexagonal, 120° without hole

Application

Chipbreaker	Designation	Material
-	HNGD050712	●
-	HNGD050716	●



P	Steel	
M	Stainless	
K	Cast iron	●●
N	Non-ferrous	
S	Superalloy	
H	Hard material	

Ceramic		Dimension (mm)									
FX105		RE	IC	S	D1						
●		1.2	12.7	7.94	-						
●		1.6	12.7	7.94	-						

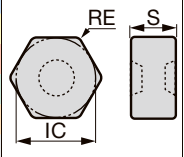

● : Line up

Grade
Insert
Ext. Toolholder
Int. Toolholder
Threading
Grooving
Miniature tool
Milling cutter
Endmill
Drilling tool
Tooling System
User's Guide
Index

A
B
C
D
E
F
G
H
I
J
K
L
M

Reference pages: HNGD...: External toolholder → **C083**

Insert POSITIVE TYPE

- : Continuous cutting
- ◐ : Light interrupted cutting
- ◑ : Heavy interrupted cutting

CC



Rhombic, 80° with hole Positive 7°

Material	P Steel	M Stainless	K Cast iron	N Non-ferrous	S Superalloy	H Hard material
●	●	●	●	●	●	●
◐	◐	◐	◐	◐	◐	◐
◑	◑	◑	◑	◑	◑	◑

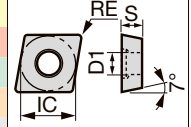

Application	Chipbreaker	Designation	Coated							Coated cermet	Cermet	Uncoated	Dimension (mm)				
			T9215	T9225	T6215	AH8005	AH8015	AH6225	AH725	SH725	GH730	J740	GT9530	NS9530	TH10	RE	IC
Finishing	PSF	CCMT060202-PSF	●	●	●	●	●	●	●	●	●	●	●	0.2	6.35	2.38	2.8
		CCMT060204-PSF	●	●	●	●	●	●	●	●	●	●	●	0.4	6.35	2.38	2.8
		CCMT09T302-PSF	●	●	●	●	●	●	●	●	●	●	●	0.2	9.525	3.97	4.4
		CCMT09T304-PSF	●	●	●	●	●	●	●	●	●	●	●	0.4	9.525	3.97	4.4
		CCMT09T308-PSF	●	●	●	●	●	●	●	●	●	●	●	0.8	9.525	3.97	4.4
		PF	CCMT060202-PF	●	●	●	●	●	●	●	●	●	●	●	0.2	6.35	2.38
	CCMT060204-PF	●	●	●	●	●	●	●	●	●	●	●	●	0.4	6.35	2.38	2.8
	CCMT060208-PF	●	●	●	●	●	●	●	●	●	●	●	●	0.8	6.35	2.38	2.8
	CCMT09T302-PF	●	●	●	●	●	●	●	●	●	●	●	●	0.2	9.525	3.97	4.4
	CCMT09T304-PF	●	●	●	●	●	●	●	●	●	●	●	●	0.4	9.525	3.97	4.4
	CCMT09T308-PF	●	●	●	●	●	●	●	●	●	●	●	●	0.8	9.525	3.97	4.4
	Finishing (sharp edge)	TSF	CCMT060202-TSF	●	●	●	●	●	●	●	●	●	●	●	0.2	6.35	2.38
CCMT060204-TSF			●	●	●	●	●	●	●	●	●	●	●	0.4	6.35	2.38	2.8
CCMT060208-TSF			●	●	●	●	●	●	●	●	●	●	●	0.8	6.35	2.38	2.8
CCMT09T302-TSF			●	●	●	●	●	●	●	●	●	●	●	0.2	9.525	3.97	4.4
CCMT09T304-TSF			●	●	●	●	●	●	●	●	●	●	●	0.4	9.525	3.97	4.4
CCMT09T308-TSF			●	●	●	●	●	●	●	●	●	●	●	0.8	9.525	3.97	4.4
J10		CCGT060200FR-J10	●	●	●	●	●	●	●	●	●	●	●	0.03	6.35	2.38	2.8
		CCGT060200FL-J10	●	●	●	●	●	●	●	●	●	●	●	0.03	6.35	2.38	2.8
		CCGT060201FR-J10	●	●	●	●	●	●	●	●	●	●	●	0.1	6.35	2.38	2.8
		CCGT060201FL-J10	●	●	●	●	●	●	●	●	●	●	●	0.1	6.35	2.38	2.8
		CCGT060202FR-J10	●	●	●	●	●	●	●	●	●	●	●	0.2	6.35	2.38	2.8
		CCGT060202FL-J10	●	●	●	●	●	●	●	●	●	●	●	0.2	6.35	2.38	2.8
J10	CCGT09T300FR-J10	●	●	●	●	●	●	●	●	●	●	●	0.03	9.525	3.97	4.4	
	CCGT09T300FL-J10	●	●	●	●	●	●	●	●	●	●	●	0.03	9.525	3.97	4.4	
	CCGT09T301FR-J10	●	●	●	●	●	●	●	●	●	●	●	0.1	9.525	3.97	4.4	
	CCGT09T301FL-J10	●	●	●	●	●	●	●	●	●	●	●	0.1	9.525	3.97	4.4	
	CCGT09T302FR-J10	●	●	●	●	●	●	●	●	●	●	●	0.2	9.525	3.97	4.4	
	CCGT09T302FL-J10	●	●	●	●	●	●	●	●	●	●	●	0.2	9.525	3.97	4.4	
CCGT09T304FR-J10	●	●	●	●	●	●	●	●	●	●	●	0.4	9.525	3.97	4.4		

*Corner radius (RE) with a sign of inequality (<) means minus tolerance.

● : Line up

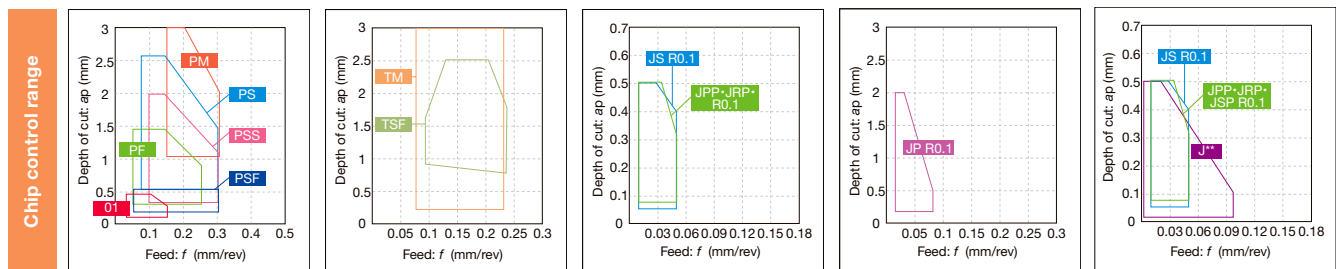

*Chip control range with typical R0.1

Reference pages: External toolholder → C030 - Internal toolholder → D014 -
 J-Series toolholder → G040 - PINZBOHR® → K178 -

Insert POSITIVE TYPE

● : Continuous cutting
 ● : Light interrupted cutting
 ✱ : Heavy interrupted cutting

CC



**Rhombic, 80°
with hole
Positive 7°**

	P	M	K	N	S	H
Steel	●●●●●●●●	●●●●●●●●	●●●●●●●●	●●●●●●●●	●●●●●●●●	●●●●●●●●
Stainless	●●●●●●●●	●●●●●●●●	●●●●●●●●	●●●●●●●●	●●●●●●●●	●●●●●●●●
Cast iron	●●●●●●●●	●●●●●●●●	●●●●●●●●	●●●●●●●●	●●●●●●●●	●●●●●●●●
Non-ferrous	●●●●●●●●	●●●●●●●●	●●●●●●●●	●●●●●●●●	●●●●●●●●	●●●●●●●●
Superalloy	●●●●●●●●	●●●●●●●●	●●●●●●●●	●●●●●●●●	●●●●●●●●	●●●●●●●●
Hard material	●●●●●●●●	●●●●●●●●	●●●●●●●●	●●●●●●●●	●●●●●●●●	●●●●●●●●

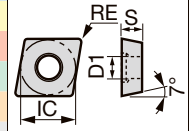

Application	Chipbreaker	Designation	Coated		Coated cermet	Cermet	Uncoated		Dimension (mm)					
			SH725	SH730	GH330	GH110	GT9530	NS9530	TH10	UX30	RE	IC	S	D1
Finishing (sharp edge)	W08	CCGT03X100FL-W08	●								0.03	3.57	1.39	1.9
		CCGT03X100FR-W08	●								0.03	3.57	1.39	1.9
		CCGT03X101FL-W08	●								0.1	3.57	1.39	1.9
		CCGT03X101FR-W08	●								0.1	3.57	1.39	1.9
		CCGT03X102FL-W08	●								0.2	3.57	1.39	1.9
		CCGT03X102FR-W08	●								0.2	3.57	1.39	1.9
		CCGT03X104FL-W08	●								0.4	3.57	1.39	1.9
		CCGT03X104FR-W08	●								0.4	3.57	1.39	1.9
		CCGT04T100FL-W08	●								0.03	4.37	1.79	2.2
		CCGT04T100FR-W08	●								0.03	4.37	1.79	2.2
		CCGT04T101FL-W08	●								0.1	4.37	1.79	2.2
		CCGT04T101FR-W08	●								0.1	4.37	1.79	2.2
		CCGT04T102FL-W08	●								0.2	4.37	1.79	2.2
		CCGT04T102FR-W08	●								0.2	4.37	1.79	2.2
		CCGT04T104FL-W08	●								0.4	4.37	1.79	2.2
		CCGT04T104FR-W08	●								0.4	4.37	1.79	2.2
Finishing	W08	CCGT03X100R-W08	●					●			0.03	3.57	1.39	1.9
		CCGT03X100L-W08	●					●			0.03	3.57	1.39	1.9
		CCGT03X101R-W08	●					●			0.1	3.57	1.39	1.9
		CCGT03X101L-W08	●					●			0.1	3.57	1.39	1.9
		CCGT03X102R-W08	●					●			0.2	3.57	1.39	1.9
		CCGT03X102L-W08	●					●			0.2	3.57	1.39	1.9
		CCGT03X104R-W08	●					●			0.4	3.57	1.39	1.9
		CCGT03X104L-W08	●					●			0.4	3.57	1.39	1.9
		CCGT04T100R-W08	●					●			0.03	4.37	1.79	2.2
		CCGT04T100L-W08	●					●			0.03	4.37	1.79	2.2
		CCGT04T101R-W08	●					●			0.1	4.37	1.79	2.2
		CCGT04T101L-W08	●					●			0.1	4.37	1.79	2.2
		CCGT04T102R-W08	●					●			0.2	4.37	1.79	2.2
		CCGT04T102L-W08	●					●			0.2	4.37	1.79	2.2
		CCGT04T104R-W08	●					●			0.4	4.37	1.79	2.2
		CCGT04T104L-W08	●					●			0.4	4.37	1.79	2.2
OTHERS	W15	CCGT060200R-W15						●			0.03	6.35	2.38	2.8
		CCGT060200L-W15						●			0.03	6.35	2.38	2.8
		CCGT060202R-W15						●			0.2	6.35	2.38	2.8
		CCGT060202L-W15				●		●			0.2	6.35	2.38	2.8
		CCGT060204R-W15		●				●			0.4	6.35	2.38	2.8
		CCGT060204L-W15		●	●		●	●	●		0.4	6.35	2.38	2.8

● : Line up

Reference pages: External toolholder → **C030** - Internal toolholder → **D014** -
 J-Series toolholder → **G040** - PINZBOHR® → **K178** -

Insert POSITIVE TYPE

- : Continuous cutting
- ◐ : Light interrupted cutting
- ✱ : Heavy interrupted cutting

CC



Rhombic, 80°
with hole
Positive 7°

	P Steel	M Stainless	K Cast iron	N Non-ferrous	S Superalloy	H Hard material	T9215	T9225	T6215	T505	T515	T5115	AH8005	AH8015	AH6225	AH6235	AH725	AH120	GH730	GH330	GH110	GT9530	AT9530	NS9530	TH10	RE	IC	S	D1	
●	●	●	●	●	●	●	●	●	●	●	●	●	●	●	●	●	●	●	●	●	●	●	●	●	●	●	●	●	●	●
◐	◐	◐	◐	◐	◐	◐	◐	◐	◐	◐	◐	◐	◐	◐	◐	◐	◐	◐	◐	◐	◐	◐	◐	◐	◐	◐	◐	◐	◐	◐
✱	✱	✱	✱	✱	✱	✱	✱	✱	✱	✱	✱	✱	✱	✱	✱	✱	✱	✱	✱	✱	✱	✱	✱	✱	✱	✱	✱	✱	✱	✱

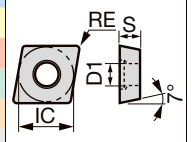

Application	Chipbreaker	Designation	Coated											Coated cermet		Cermet	Uncoated	Dimension (mm)															
			T9215	T9225	T6215	T505	T515	T5115	AH8005	AH8015	AH6225	AH6235	AH725	AH120	GH730			GH330	GH110	GT9530	AT9530	NS9530	TH10	RE	IC	S	D1						
Finishing		W20 CCGT09T302R-W20																									●	●	●	●			
		CCGT09T302L-W20																										●	●	●	●		
		CCGT09T304R-W20																											●	●	●	●	
		CCGT09T304L-W20																											●	●	●	●	
		CCGT09T308R-W20																												●	●	●	●
		CCGT09T308L-W20																												●	●	●	●
Finishing to medium cutting		PSS CCMT060204-PSS	●	●	●								●	●	●	●	●	●					●	●				●	●	●	●		
		CCMT060208-PSS	●	●	●									●	●	●	●	●	●					●	●				●	●	●	●	
		CCMT09T304-PSS	●	●	●									●	●	●	●	●	●					●	●				●	●	●	●	
		CCMT09T308-PSS	●	●	●									●	●	●	●	●	●					●	●				●	●	●	●	
		CCMT120404-PSS	●	●	●										●	●	●	●	●										●	●	●	●	
		CCMT120408-PSS	●	●	●											●	●	●	●										●	●	●	●	
		CCMT120412-PSS	●	●	●												●	●	●										●	●	●	●	
		PS CCMT060202-PS	●	●	●										●	●	●	●	●	●					●	●				●	●	●	●
		CCMT060204-PS	●	●	●										●	●	●	●	●	●					●	●				●	●	●	●
		CCMT060208-PS	●	●	●										●	●	●	●	●	●					●	●				●	●	●	●
		CCMT09T302-PS	●	●	●										●	●	●	●	●	●					●	●				●	●	●	●
		CCMT09T304-PS	●	●	●										●	●	●	●	●	●					●	●				●	●	●	●
		CCMT09T308-PS	●	●	●										●	●	●	●	●	●					●	●				●	●	●	●
		CCMT120404-PS	●	●	●											●	●	●	●	●										●	●	●	●
CCMT120408-PS	●	●	●												●	●	●	●										●	●	●	●		
CCMT120412-PS	●	●	●													●	●	●										●	●	●	●		
Finishing to medium cutting		TM CCMT060202-TM	●	●	●									●	●													●	●	●	●		
		CCMT060204-TM	●	●	●										●	●													●	●	●	●	
		CCMT060208-TM	●	●	●											●	●												●	●	●	●	
		CCMT09T302-TM	●	●	●											●	●												●	●	●	●	
		CCMT09T304-TM	●	●	●											●	●												●	●	●	●	
		CCMT09T308-TM	●	●	●												●	●											●	●	●	●	
Finishing to medium cutting		CM CCMT060204-CM			●	●	●																					●	●	●	●		
		CCMT060208-CM			●	●	●																						●	●	●	●	
		CCMT09T304-CM			●	●	●																						●	●	●	●	
		CCMT09T308-CM			●	●	●																						●	●	●	●	
		CCMT09T312-CM					●																						●	●	●	●	
		CCMT120404-CM					●																						●	●	●	●	
CCMT120408-CM					●																						●	●	●	●			

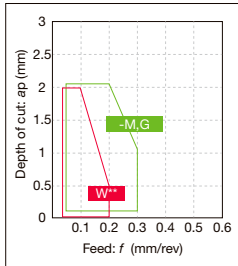
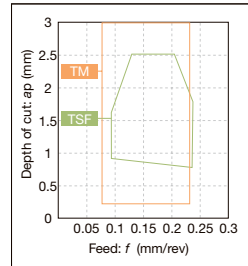
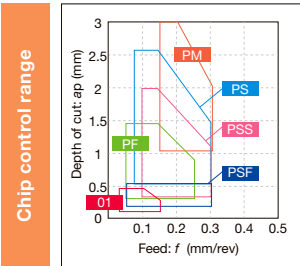

*-M,G: Without chipbreaker

Reference pages: External toolholder → C030 - Internal toolholder → D014 -
J-Series toolholder → G040 - PINZBOHR® → K178 -

Grade
Insert
Ext. Toolholder
Int. Toolholder
Threading
Grooving
Miniature tool
Milling cutter
Endmill
Drilling tool
Tooling System
User's Guide
Index

● : Continuous cutting
 ● : Light interrupted cutting
 ✱ : Heavy interrupted cutting

Insert POSITIVE TYPE

CC



**Rhombic, 80°
with hole
Positive 7°**

	P Steel	M Stainless	K Cast iron	N Non-ferrous	S Superalloy	H Hard material
●	●	●	●	●	●	●
●	●	●	●	●	●	●
●	●	●	●	●	●	●
●	●	●	●	●	●	●
●	●	●	●	●	●	●
●	●	●	●	●	●	●
●	●	●	●	●	●	●
●	●	●	●	●	●	●
●	●	●	●	●	●	●
●	●	●	●	●	●	●
●	●	●	●	●	●	●

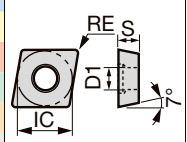

Application	Chipbreaker	Designation	Coated		Cermet	Uncoated		Dimension (mm)						
			T9215	T9225		T5115	NS9530	TH10	KS05F	RE	IC	S	D1	
Finishing to light cutting for non-ferrous metal		AL CCGT060202-AL						●		0.2	6.35	2.38	2.8	
		CCGT060204-AL						●		0.4	6.35	2.38	2.8	
		CCGT09T302-AL						●		0.2	9.525	3.97	4.4	
		CCGT09T304-AL						●		0.4	9.525	3.97	4.4	
		CCGT09T308-AL						●		0.8	9.525	3.97	4.4	
		CCGT120402-AL						●		0.2	12.7	4.76	5.5	
		CCGT120404-AL						●		0.4	12.7	4.76	5.5	
		CCGT120408-AL						●		0.8	12.7	4.76	5.5	
Finishing to medium cutting		SW CCMT060204-SW	●	●		●				0.4	6.35	2.38	2.8	
		CCMT060208-SW	●	●		●				0.8	6.35	2.38	2.8	
		CCMT09T304-SW	●	●		●				0.4	9.525	3.97	4.4	
		CCMT09T308-SW	●	●		●				0.8	9.525	3.97	4.4	
Finishing to medium cutting		All-round CCGT060202				●				0.2	6.35	2.38	2.8	
		CCGT060204				●				0.4	6.35	2.38	2.8	
		CCGT09T302				●				0.2	9.525	3.97	4.4	
		CCGT09T304				●				0.4	9.525	3.97	4.4	
		CCGT09T308				●				0.8	9.525	3.97	4.4	
		Angular CCGT060200R							●		0.03	6.35	2.38	2.8
		CCGT060202R							●		0.2	6.35	2.38	2.8
		CCGT060202L							●		0.2	6.35	2.38	2.8
		CCGT060204L							●		0.4	6.35	2.38	2.8
		CCGT09T302R							●		0.2	9.525	3.97	4.4
		CCGT09T302L							●		0.2	9.525	3.97	4.4
		CCGT09T304R							●		0.4	9.525	3.97	4.4
		CCGT09T304L							●		0.4	9.525	3.97	4.4
		23 CCMT060202-23				●					0.2	6.35	2.38	2.8
		CCMT060204-23		●		●					0.4	6.35	2.38	2.8
		CCMT060208-23		●		●					0.8	6.35	2.38	2.8
		CCMT09T304-23		●		●					0.4	9.525	3.97	4.4
		CCMT09T308-23		●		●					0.8	9.525	3.97	4.4
	- CCMW060204		●							0.4	6.35	2.38	2.8	
	CCMW060208		●							0.8	6.35	2.38	2.8	
	CCMW09T304		●							0.4	9.525	3.97	4.4	
	CCMW09T308		●							0.8	9.525	3.97	4.4	

* Please see L011 - L015 about the adjustment of the machining program for rounding or taper machining by using SW/FW.
 Please contact our sales representatives if you have any question.

● : Line up

Reference pages: External toolholder → **C030 -** Internal toolholder → **D014 -**
 J-Series toolholder → **G040 -** PINZBOHR® → **K178 -**

Insert POSITIVE TYPE

- : Continuous cutting
- ◐ : Light interrupted cutting
- ◑ : Heavy interrupted cutting

CC



Rhombic, 80° with hole Positive 7°

Material	P Steel	M Stainless	K Cast iron	N Non-ferrous	S Superalloy	H Hard material	Coated	Coated cermet	Cermet	Uncoated						
P Steel	●	◐	◐	◐	◐	◐	◐	◐	◐	●	●	●	●	●	●	●
M Stainless	◐	●	◐	◐	◐	◐	◐	◐	◐	●	●	●	●	●	●	●
K Cast iron	◐	◐	●	◐	◐	◐	◐	◐	◐	●	●	●	●	●	●	●
N Non-ferrous	◐	◐	◐	●	◐	◐	◐	◐	◐	●	●	●	●	●	●	●
S Superalloy	◐	◐	◐	◐	●	◐	◐	◐	◐	●	●	●	●	●	●	●
H Hard material	◐	◐	◐	◐	◐	◐	◐	◐	◐	●	●	●	●	●	●	●

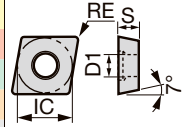

Application	Chipbreaker	Designation	Coated								Coated cermet	Cermet	Uncoated	Dimension (mm)			
			T9215	T9225	T6215	AH6225	AH6235	AH725	AH120	GH730	GH110	GT9530	NS9530	TH10	RE	IC	S
Finishing to medium cutting	-	CCGW060202											●	0.2	6.35	2.38	2.8
		CCGW060204											●	0.4	6.35	2.38	2.8
		CCGW09T304								●			●	0.4	9.525	3.97	4.4
Medium cutting	PM	CCMT060204-PM	●	●	●	●	●	●	●	●	●	●		0.4	6.35	2.38	2.8
		CCMT060208-PM	●	●	●	●	●	●	●	●	●	●		0.8	6.35	2.38	2.8
		CCMT09T304-PM	●	●	●	●	●	●	●	●	●	●		0.4	9.525	3.97	4.4
		CCMT09T308-PM	●	●	●	●	●	●	●	●	●	●		0.8	9.525	3.97	4.4
		CCMT09T312-PM	●	●	●	●	●	●	●	●	●	●		1.2	9.525	3.97	4.4
		CCMT120408-PM			●	●	●	●	●	●	●	●		0.8	12.7	4.76	5.5
			CCMT120412-PM			●	●	●	●	●	●		1.2	12.7	4.76	5.5	
	24		CCMT060202-24		●								●	0.2	6.35	2.38	2.8
			CCMT060204-24	●	●				●				●	0.4	6.35	2.38	2.8
			CCMT060208-24	●	●	●							●	0.8	6.35	2.38	2.8
			CCMT09T302-24		●								●	0.2	9.525	3.97	4.4
			CCMT09T304-24	●	●								●	0.4	9.525	3.97	4.4
			CCMT09T308-24	●	●	●			●				●	0.8	9.525	3.97	4.4
			CCMT120408-24	●	●				●				●	0.8	12.7	4.76	5.5

● : Line up

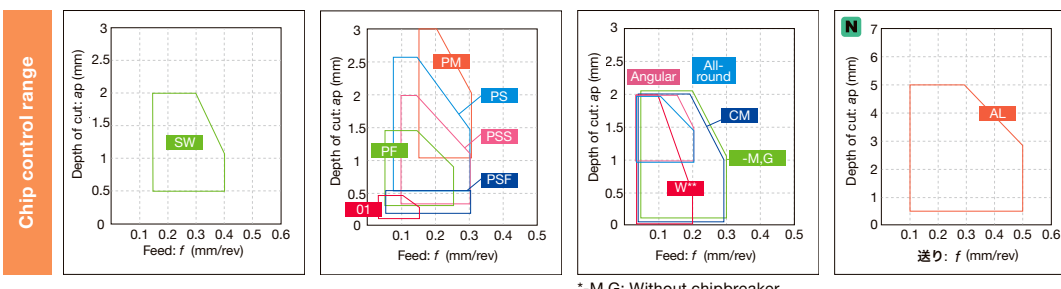

*-M,G: Without chipbreaker

Reference pages: External toolholder → C030 - Internal toolholder → D014 -
 J-Series toolholder → G040 - PINZBOHR® → K178 -



Insert POSITIVE TYPE

- : Continuous cutting
- ◐ : Light interrupted cutting
- ◑ : Heavy interrupted cutting

CP



Rhombic, 80°
with hole
Positive 11°

	P Steel	M Stainless	K Cast iron	N Non-ferrous	S Superalloy	H Hard material
●	●	●	●	●	●	●
◐	◐	◐	◐	◐	◐	◐
◑	◑	◑	◑	◑	◑	◑

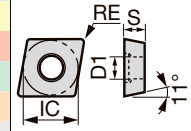

Application	Chipbreaker	Designation	Coated						Coated cermet	Cermet	Uncoated	Dimension (mm)				
			T9215	T9225	T6215	AH8015	AH6225	AH6235	AH725	GT9530	NS9530	TH10	RE	IC	S	D1
PSF	CPMT060202-PSF											0.2	6.35	2.38	2.8	
	CPMT060204-PSF	● ●										0.4	6.35	2.38	2.8	
	CPMT080202-PSF											0.2	7.94	2.38	3.4	
	CPMT080204-PSF	● ●										0.4	7.94	2.38	3.4	
	CPMT090302-PSF							●	●			0.2	9.525	3.18	4.4	
	CPMT090304-PSF	● ●						●	●			0.4	9.525	3.18	4.4	
	CPMT09T302-PSF											0.2	9.525	3.97	4.4	
	CPMT09T304-PSF	● ●										0.4	9.525	3.97	4.4	
	PF	CPMT090302-PF							●	●			0.2	9.525	3.18	4.4
		CPMT090304-PF							●	●			0.4	9.525	3.18	4.4
TSF	CPMT060202-TSF		● ● ● ● ●						●			0.2	6.35	2.38	2.8	
	CPMT060204-TSF	● ● ● ● ●							●			0.4	6.35	2.38	2.8	
	CPMT060208-TSF	● ● ● ● ●							●			0.8	6.35	2.38	2.8	
	CPMT09T302-TSF	● ● ● ● ●							●			0.2	9.525	3.97	4.4	
	CPMT09T304-TSF	● ● ● ● ●							●			0.4	9.525	3.97	4.4	
	CPMT09T308-TSF	● ● ● ● ●							●			0.8	9.525	3.97	4.4	
	W15	CPGT050202L-W15								●			0.2	5.56	2.35	2.5
CPGT050204L-W15									●			0.4	5.56	2.35	2.5	
CPGT080202R-W15										●		0.2	7.94	2.38	3.4	
CPGT080202L-W15									●			0.2	7.94	2.38	3.4	
CPGT080204R-W15										●		0.4	7.94	2.38	3.4	
CPGT080204L-W15									●			0.4	7.94	2.38	3.4	
W20	CPGT090302R-W20								●			0.2	9.525	3.18	4.4	
	CPGT090302L-W20								●			0.2	9.525	3.18	4.4	
	CPGT090304R-W20								●			0.4	9.525	3.18	4.4	
	CPGT090304L-W20								●			0.4	9.525	3.18	4.4	
PSS	CPMT060204-PSS	● ●							●	●		0.4	6.35	2.38	2.8	
	CPMT080204-PSS	● ● ●							●	●		0.4	7.94	2.38	3.4	
	CPMT080208-PSS	● ● ● ● ●							●	●		0.8	7.94	2.38	3.4	
	CPMT090304-PSS	● ● ● ● ●							●	●		0.4	9.525	3.18	4.4	
	CPMT090308-PSS	● ● ● ● ●							●	●		0.8	9.525	3.18	4.4	
	CPMT09T304-PSS	● ●										0.4	9.525	3.97	4.4	
	CPMT09T308-PSS	● ●										0.8	9.525	3.97	4.4	

● : Line up

Reference pages: Internal toolholder → **D018 -** Cartridge → **K181 -**
Boring bar tool → **K199**

Insert POSITIVE TYPE

- : Continuous cutting
- ◐ : Light interrupted cutting
- ◑ : Heavy interrupted cutting

CP



Rhombic, 80° with hole Positive 11°

Material	P Steel	M Stainless	K Cast iron	N Non-ferrous	S Superalloy	H Hard material	Coated	Coated cermet	Cermet	Uncoated
●	●	●	●	●	●	●	●	●	●	●
◐	◐	◐	◐	◐	◐	◐	◐	◐	◐	◐
◑	◑	◑	◑	◑	◑	◑	◑	◑	◑	◑

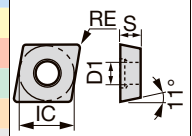

Application	Chipbreaker	Designation	Coated										Coated cermet	Cermet	Uncoated	Dimension (mm)													
			T9215	T9225	T6215	T505	T515	T5115	AH8005	AH8015	AH6225	AH6235	AH905	AH725	AH120	GH730	GT9530	AT9530	NS9530	TH10	RE	IC	S	D1					
Finishing to medium cutting		PS CPMT060202-PS	●	●	●																●				0.2	6.35	2.38	2.8	
		CPMT060204-PS	●	●	●																●				0.4	6.35	2.38	2.8	
		CPMT060208-PS	●	●	●																●				0.8	6.35	2.38	2.8	
		CPMT080202-PS	●	●	●																●				0.2	7.94	2.38	3.4	
		CPMT080204-PS	●	●	●																●				0.4	7.94	2.38	3.4	
		CPMT080208-PS	●	●	●																●				0.8	7.94	2.38	3.4	
		CPMT090304-PS	●	●	●																●				0.4	9.525	3.18	4.4	
		CPMT090308-PS	●	●	●																●	●			0.8	9.525	3.18	4.4	
		CPMT09T302-PS	●	●	●																●				0.2	9.525	3.97	4.4	
		CPMT09T304-PS	●	●	●																●				0.4	9.525	3.97	4.4	
		CPMT09T308-PS	●	●	●																●				0.8	9.525	3.97	4.4	
		Finishing to medium cutting		TM CPMT060202-TM	●	●	●															●				0.2	6.35	2.38	2.8
CPMT060204-TM	●			●	●															●				0.4	6.35	2.38	2.8		
CPMT060208-TM	●			●	●															●				0.8	6.35	2.38	2.8		
CPMT09T302-TM	●			●	●															●				0.2	9.525	3.97	4.4		
CPMT09T304-TM	●			●	●															●				0.4	9.525	3.97	4.4		
CPMT09T308-TM	●			●	●															●				0.8	9.525	3.97	4.4		
Finishing to medium cutting				CM CPMT060204-CM																						0.4	6.35	2.38	2.8
				CPMT060208-CM																						0.8	6.35	2.38	2.8
				CPMT080204-CM																						0.4	7.94	2.38	3.4
				CPMT080208-CM																						0.8	7.94	2.38	3.4
		CPMT090304-CM				●	●	●																0.4	9.525	3.18	4.4		
		CPMT090308-CM				●	●	●																0.8	9.525	3.18	4.4		
		CPMT09T304-CM				●	●	●																0.4	9.525	3.97	4.4		
		CPMT09T308-CM				●	●	●																0.8	9.525	3.97	4.4		
All-round		CPMT09T312-CM																					1.2	9.525	3.97	4.4			
		CPMT120408-CM																						0.8	12.7	4.76	5.5		
		CPMT120412-CM																						1.2	12.7	4.76	5.5		
		CPMT120408																					0.8	12.7	4.76	5.5			

● : Line up

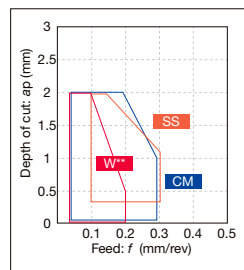
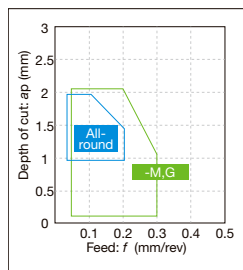
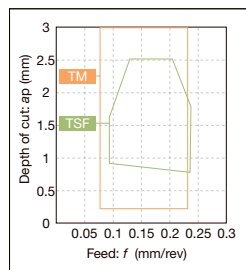
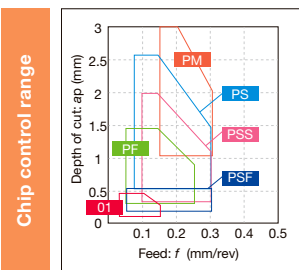

*-M,G: Without chipbreaker

Reference pages: Internal toolholder → **D018** - Cartridge → **K181** -
Boring bar tool → **K199**

Grade
Insert
Toolholder
Ext. Toolholder
Int. Toolholder
Threading
Grooving
Miniature tool
Milling cutter
Endmill
Drilling tool
Tooling System
User's Guide
Index

Insert POSITIVE TYPE

- : Continuous cutting
- ◐ : Light interrupted cutting
- ✱ : Heavy interrupted cutting

DC

Rhombic, 55°
with hole
Positive 7°



	P	M	K	N	S	H	T9215	T9225	AH8005	AH8015	AH905	AH725	SH725	SH730	J740	GT9530	J9530	NS9530	
Steel	● ● ● ● ✱															● ● ● ●			● ●
Stainless	● ●	● ●														● ● ● ●			● ●
Cast iron	● ●		● ●													● ● ● ●			● ●
Non-ferrous				● ●															
Superalloy					● ●														
Hard material						● ●													

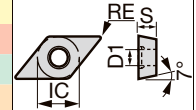

Application	Chipbreaker	Designation	Coated			Coated cermet		Cermet	Dimension (mm)															
			T9215	T9225	AH8005	AH8015	AH905	AH725	SH725	SH730	J740	GT9530	J9530	NS9530	RE	IC	S	D1						
Precision finishing (sharp edge)		JP DCGT070200FN-JP								●										<0.05	6.35	2.38	2.8	
		DCGT070201FN-JP								●											<0.1	6.35	2.38	2.8
		DCGT070202FN-JP								●											<0.2	6.35	2.38	2.8
		DCGT11T300FN-JP								●											<0.05	9.525	3.97	4.4
		DCGT11T301FN-JP								●											<0.1	9.525	3.97	4.4
		DCGT11T302FN-JP								●											<0.2	9.525	3.97	4.4
		01 DCGT070202F-01												●							<0.2	6.35	2.38	2.8
		DCGT070204F-01												●							<0.4	6.35	2.38	2.8
Precision finishing		01 DCGT11T302F-01																		<0.2	9.525	3.97	4.4	
		DCGT11T304F-01																			<0.4	9.525	3.97	4.4
		01 DCGT070202-01													●		●				0.2	6.35	2.38	2.8
		DCGT11T302-01													●						0.2	9.525	3.97	4.4
Finishing (sharp edge)		JS DCGT070200FN-JS											● ●							<0.05	6.35	2.38	2.8	
		DCGT070201FN-JS											● ●								<0.1*	6.35	2.38	2.8
		DCGT070202FN-JS											● ●								<0.2*	6.35	2.38	2.8
		DCGT11T300FN-JS											● ●								0.03	9.525	3.97	4.4
		DCGT11T301FN-JS											● ●								<0.1*	9.525	3.97	4.4
		DCGT11T302FN-JS											● ●								<0.2*	9.525	3.97	4.4
		DCGT11T304FN-JS											● ●								<0.4*	9.525	3.97	4.4
		Finishing		JS DCGT070201N-JS											●							0.1	6.35	2.38
DCGT070202N-JS													●								0.2	6.35	2.38	2.8
DCGT11T301N-JS													●								0.1	9.525	3.97	4.4
DCGT11T302N-JS													●								0.2	9.525	3.97	4.4
DCGT11T304N-JS													●								0.4	9.525	3.97	4.4
PSF DCGT070202-PSF																		●		●	0.2	6.35	2.38	2.8
Drilling System		PSF DCGT070204-PSF	● ●									●				●		●	0.4	6.35	2.38	2.8		
		DCMT11T302-PSF															●		●	0.2	9.525	3.97	4.4	
		DCMT11T304-PSF	● ● ● ● ● ● ● ●														●		●	0.4	9.525	3.97	4.4	
		DCMT11T308-PSF	● ● ● ● ● ● ● ●																		0.8	9.525	3.97	4.4

*Corner radius (RE) with a sign of inequality (<) means minus tolerance.

● : Line up

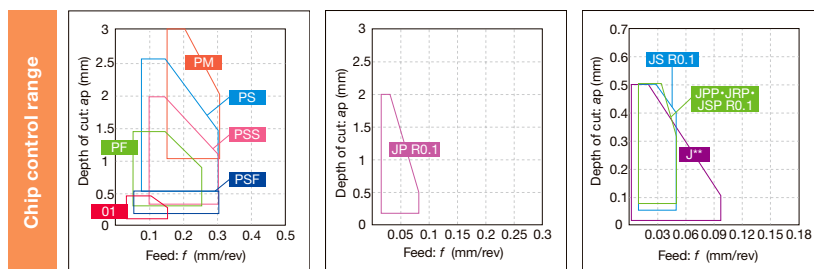

*Chip control range with typical R0.1

Reference pages: External toolholder → **C046 -** Internal toolholder → **D056 -**
J-Series toolholder → **G052 -**



Insert POSITIVE TYPE

● : Continuous cutting
 ● : Light interrupted cutting
 ✱ : Heavy interrupted cutting

DC

Rhombic, 55°
 with hole
 Positive 7°

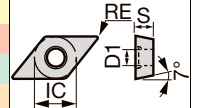

P Steel	●●●✱	●	●●●	●●●	●●●	●●●	●●●	●●●	●●●	●●●	●●●	●●●	●	●	●	●
M Stainless	●●	●	●	●●	●●	●●	●●	●●	●●	●●	●●	●●	●●	●●	●●	●●
K Cast iron	●●	●	●	●●	●●	●●	●●	●●	●●	●●	●●	●●	●●	●●	●●	●●
N Non-ferrous																
S Superalloy			●													
H Hard material																

Application	Chipbreaker	Designation	Coated							Coated cemet	Cermet	Uncoated	Dimension (mm)						
			T9215	T9225	T6215	AH8015	AH6225	SH725	J740	GH730	GH330	GT9530 J9530	NS9530	TH10	RE	IC	S	D1	
Finishing		PF DCMT070202-PF							●		●	●		0.2	6.35	2.38	2.8		
		DCMT070204-PF				●			●		●	●		0.4	6.35	2.38	2.8		
		DCMT070208-PF				●			●		●	●		0.8	6.35	2.38	2.8		
		DCMT11T302-PF							●		●	●		0.2	9.525	3.97	4.4		
		DCMT11T304-PF							●		●	●		0.4	9.525	3.97	4.4		
		DCMT11T308-PF							●		●	●		0.8	9.525	3.97	4.4		
		TSF DCMT070202-TSF		●●●●●								●		0.2	6.35	2.38	2.8		
		DCMT070204-TSF		●●●●●								●		0.4	6.35	2.38	2.8		
		DCMT070208-TSF		●●●●●								●		0.8	6.35	2.38	2.8		
		DCMT11T302-TSF		●●●●●								●		0.2	9.525	3.97	4.4		
		DCMT11T304-TSF		●●●●●								●		0.4	9.525	3.97	4.4		
		DCMT11T308-TSF		●●●●●								●		0.8	9.525	3.97	4.4		
	Finishing (sharp edge)		J10 DCGT070200FR-J10					●●							0.03	6.35	2.38	2.8	
			DCGT070200FL-J10					●●							0.03	6.35	2.38	2.8	
			DCGT070201FR-J10					●●				●			0.1	6.35	2.38	2.8	
DCGT070201FL-J10							●●				●			0.1	6.35	2.38	2.8		
DCGT070202FR-J10							●●				●			0.2	6.35	2.38	2.8		
DCGT070202FL-J10							●●				●			0.2	6.35	2.38	2.8		
DCGT070204FR-J10							●							0.4	6.35	2.38	2.8		
DCGT070204FL-J10							●							0.4	6.35	2.38	2.8		
DCGT11T300FR-J10							●●					●			0.03	9.525	3.97	4.4	
DCGT11T300FL-J10							●●					●			0.03	9.525	3.97	4.4	
DCGT11T301FR-J10						●●					●			0.1	9.525	3.97	4.4		
DCGT11T301FL-J10						●●					●			0.1	9.525	3.97	4.4		
DCGT11T302FR-J10						●●					●			0.2	9.525	3.97	4.4		
DCGT11T302FL-J10						●●					●			0.2	9.525	3.97	4.4		
Finishing			J10 DCGT070202R-J10								●				0.2	6.35	2.38	2.8	
	DCGT11T302R-J10									●				0.2	9.525	3.97	4.4		
		W10 DCGT070200R-W10											●		0.03	6.35	2.38	2.8	
		DCGT070200L-W10											●		0.03	6.35	2.38	2.8	
		DCGT070202R-W10									●		●		0.2	6.35	2.38	2.8	
		DCGT070202L-W10									●				0.2	6.35	2.38	2.8	
		DCGT070204R-W10									●		●		0.4	6.35	2.38	2.8	
		DCGT070204L-W10									●		●		0.4	6.35	2.38	2.8	
		W15 DCGT11T302R-W15										●		●		0.2	9.525	3.97	4.4
		DCGT11T302L-W15									●		●		0.2	9.525	3.97	4.4	
DCGT11T304R-W15											●		●		0.4	9.525	3.97	4.4	
DCGT11T304L-W15										●		●		0.4	9.525	3.97	4.4		
DCGT11T308R-W15										●		●		0.8	9.525	3.97	4.4		
DCGT11T308L-W15										●		●		0.8	9.525	3.97	4.4		

Reference pages: External toolholder → **C046 -** Internal toolholder → **D056 -** ● : Line up
 J-Series toolholder → **G052 -**

Insert POSITIVE TYPE

● : Continuous cutting
 ○ : Light interrupted cutting
 ☆ : Heavy interrupted cutting

DC

**Rhombic, 55°
 with hole
 Positive 7°**



P	Steel	●●●●
M	Stainless	●●●●
K	Cast iron	
N	Non-ferrous	
S	Superalloy	●●
H	Hard material	

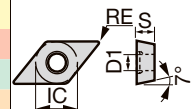

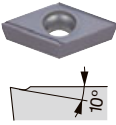
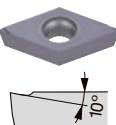
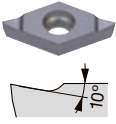
Application	Chipbreaker	Designation	Coated		Dimension (mm)				
			SH725	SH730	RE	IC	S	D1	
Finishing (sharp edge)		JPP	DCET0702008MFR-JPP	●●		<0.08*	6.35	2.38	2.8
			DCET070201MFR-JPP	●●		<0.1*	6.35	2.38	2.8
			DCET070201MFL-JPP	●●		<0.1*	6.35	2.38	2.8
			DCET070202MFR-JPP	●●		<0.2*	6.35	2.38	2.8
			DCET070202MFL-JPP	●●		<0.2*	6.35	2.38	2.8
			DCET11T3008MFR-JPP	●●		<0.08*	9.525	3.97	4.4
			DCET11T301MFR-JPP	●●		<0.1*	9.525	3.97	4.4
			DCET11T301MFL-JPP	●●		<0.1*	9.525	3.97	4.4
			DCET11T3018MFR-JPP	●●		<0.18*	9.525	3.97	4.4
			DCET11T3018MFL-JPP	●●		<0.18*	9.525	3.97	4.4
			DCET11T302MFR-JPP	●●		<0.2*	9.525	3.97	4.4
			DCET11T302MFL-JPP	●●		<0.2*	9.525	3.97	4.4
		JRP	DCET0702008MFR-JRP	●●		<0.08*	6.35	2.38	2.8
			DCET070201MFR-JRP	●●		<0.1*	6.35	2.38	2.8
			DCET070201MFL-JRP	●●		<0.1*	6.35	2.38	2.8
			DCET0702018MFR-JRP	●●		<0.18*	6.35	2.38	2.8
			DCET0702018MFL-JRP	●●		<0.18*	6.35	2.38	2.8
			DCET070202MFR-JRP	●●		<0.2*	6.35	2.38	2.8
			DCET070202MFL-JRP	●●		<0.2*	6.35	2.38	2.8
			DCET11T3008MFR-JRP	●●		<0.08*	9.525	3.97	4.4
			DCET11T301MFR-JRP	●●		<0.1*	9.525	3.97	4.4
			DCET11T3018MFR-JRP	●●		<0.18*	9.525	3.97	4.4
			DCET11T3018MFL-JRP	●●		<0.18*	9.525	3.97	4.4
			JSP	DCET0702008MFN-JSP	●●		<0.08*	6.35	2.38
			DCET070201MFN-JSP	●●		<0.1*	6.35	2.38	2.8
			DCET070202MFN-JSP	●●		<0.2*	6.35	2.38	2.8
			DCET11T3008MFN-JSP	●●		<0.08*	9.525	3.97	4.4
			DCET11T301MFN-JSP	●●		<0.1*	9.525	3.97	4.4
			DCET11T3018MFN-JSP	●●		<0.18*	9.525	3.97	4.4
		DCET11T302MFN-JSP	●●		<0.2*	9.525	3.97	4.4	

*Corner radius (RE) with a sign of inequality (<) means minus tolerance.

● : Line up

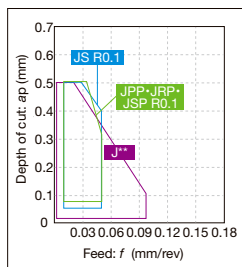
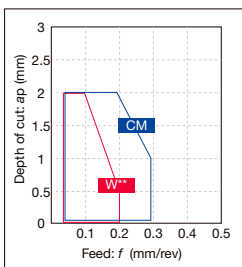
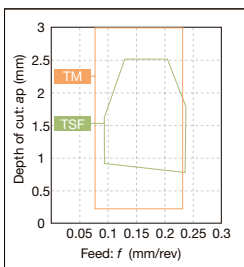
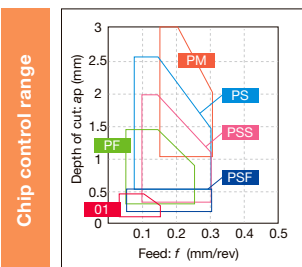

*Chip control range with typical R0.1

Reference pages: External toolholder → C046 -
 J-Series toolholder → G052 -

Internal toolholder → D056 -

Insert POSITIVE TYPE

- : Continuous cutting
- ◐ : Light interrupted cutting
- ✱ : Heavy interrupted cutting

DC



Rhombic, 55°
with hole
Positive 7°

	P Steel	M Stainless	K Cast iron	N Non-ferrous	S Superalloy	H Hard material	T9215	T9225	T6215	T505	T515	T5115	AH8005	AH8015	AH6225	AH6235	AH905	AH725	AH120	GH730	GT9530	AT9530	NS9530	KS05F	TH10	
P Steel	●	●	✱	●												✱	✱	●	●	●		●	●	●	●	●
M Stainless	●	●		●									●	●	●	●	●	●	●	●		●	●		●	●
K Cast iron	●	●							●	●	●	●						●	●	●		●	●		●	●
N Non-ferrous				●																					●	●
S Superalloy					●								●	●			●	●	●	●					●	●
H Hard material						●							●	●			●	●	●	●					●	●

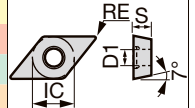

Application	Chipbreaker	Designation	Coated										Coated cermet		Cermet	Uncoated		Dimension (mm)											
			T9215	T9225	T6215	T505	T515	T5115	AH8005	AH8015	AH6225	AH6235	AH905	AH725	AH120	GH730	GT9530	AT9530	NS9530	KS05F	TH10	RE	IC	S	D1				
Finishing to medium cutting		PSS DCMT070204-PSS	●	●	●									●	●			●	●						0.4	6.35	2.38	2.8	
		DCMT070208-PSS	●	●	●										●	●			●	●						0.8	6.35	2.38	2.8
		DCMT11T304-PSS	●	●	●									●	●	●	●	●								0.4	9.525	3.97	4.4
		DCMT11T308-PSS	●	●	●									●	●	●	●	●								0.8	9.525	3.97	4.4
		DCMT11T312-PSS	●	●	●									●	●	●	●	●								1.2	9.525	3.97	4.4
Finishing to medium cutting		PS DCMT070202-PS	●	●	●								●	●	●	●	●									0.2	6.35	2.38	2.8
		DCMT070204-PS	●	●	●									●	●	●	●									0.4	6.35	2.38	2.8
		DCMT070208-PS	●	●	●									●	●			●	●							0.8	6.35	2.38	2.8
		DCMT11T302-PS	●	●	●									●	●	●	●	●								0.2	9.525	3.97	4.4
		DCMT11T304-PS	●	●	●									●	●	●	●	●								0.4	9.525	3.97	4.4
		DCMT11T308-PS	●	●	●									●	●	●	●	●								0.8	9.525	3.97	4.4
Finishing to medium cutting		TM DCMT070202-TM	●	●	●								●	●												0.2	6.35	2.38	2.8
		DCMT070204-TM	●	●	●									●	●											0.4	6.35	2.38	2.8
		DCMT070208-TM	●	●	●									●	●											0.8	6.35	2.38	2.8
		DCMT11T302-TM	●	●	●									●	●											0.2	9.525	3.97	4.4
		DCMT11T304-TM	●	●	●									●	●											0.4	9.525	3.97	4.4
		DCMT11T308-TM	●	●	●									●	●											0.8	9.525	3.97	4.4
Finishing to medium cutting		CM DCMT070204-CM											●													0.4	6.35	2.38	2.8
		DCMT070208-CM											●													0.8	6.35	2.38	2.8
		DCMT11T304-CM				●	●	●																		0.4	9.525	3.97	4.4
		DCMT11T308-CM				●	●	●																		0.8	9.525	3.97	4.4
		DCMT11T312-CM												●												1.2	9.525	3.97	4.4
Finishing to medium cutting for non-ferrous alloys		AL DCGT070202-AL																							●	0.2	6.35	2.38	2.8
		DCGT070204-AL																							●	0.4	6.35	2.38	2.8
		DCGT11T302-AL																							●	0.2	9.525	3.97	4.4
		DCGT11T304-AL																							●	0.4	9.525	3.97	4.4
		DCGT11T308-AL																							●	0.8	9.525	3.97	4.4
Finishing to medium cutting		All-round DCGT070202																						●	0.2	6.35	2.38	2.8	
		DCGT070204																						●	0.4	6.35	2.38	2.8	
		DCGT11T302																						●	0.2	9.525	3.97	4.4	
		DCGT11T304																						●	0.4	9.525	3.97	4.4	
		DCGT11T308																						●	0.8	9.525	3.97	4.4	
Finishing to medium cutting		Angular DCGT070202R																							●	0.2	6.35	2.38	2.8
		DCGT070202L																							●	0.2	6.35	2.38	2.8
		DCGT070204R																							●	0.4	6.35	2.38	2.8
		DCGT070204L																							●	0.4	6.35	2.38	2.8
		DCGT11T302R																							●	0.2	9.525	3.97	4.4
		DCGT11T302L																							●	0.2	9.525	3.97	4.4
		DCGT11T304R																							●	0.4	9.525	3.97	4.4
		DCGT11T304L																							●	0.4	9.525	3.97	4.4

Reference pages: External toolholder → C046 - Internal toolholder → D056 -
J-Series toolholder → G052 -

● : Line up

Insert POSITIVE TYPE

● : Continuous cutting
 ● : Light interrupted cutting
 ✱ : Heavy interrupted cutting

DC

Rhombic, 55°
 with hole
 Positive 7°



Material	Steel	Stainless	Cast iron	Non-ferrous	Superalloy	Hard material	Coated	Coated cermet	Cermet	Uncoated	Dimension (mm)
P	●●●✱	●●	●●	●	●●	●	●●	●●	●●	●	RE
M	●●	●●	●●	●●	●●	●	●●	●●	●●	●	IC
K	●●	●●	●●	●●	●●	●	●●	●●	●●	●	S
N	●●	●●	●●	●●	●●	●	●●	●●	●●	●	D1
S	●●	●●	●●	●●	●●	●	●●	●●	●●	●	
H	●●	●●	●●	●●	●●	●	●●	●●	●●	●	

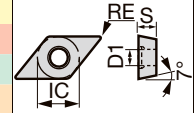

Application	Chipbreaker	Designation	Coated										Coated cermet	Cermet	Uncoated	Dimension (mm)					
			T9215	T9225	T6215	T5115	AH6225	AH6235	AH725	AH120	GH730	GH110	GT9530	NS9530	TH10	RE	IC	S	D1		
Finishing to medium cutting	23	DCMT070204-23												●			0.4	6.35	2.38	2.8	
		DCMT11T304-23												●			0.4	9.525	3.97	4.4	
		DCMT11T308-23												●			0.8	9.525	3.97	4.4	
	-	DCMW070204				●												0.4	6.35	2.38	2.8
		DCMW070208				●												0.8	6.35	2.38	2.8
		DCMW11T304				●												0.4	9.525	3.97	4.4
		DCMW11T308				●												0.8	9.525	3.97	4.4
	-	DCGW070202													●			0.2	6.35	2.38	2.8
		DCGW070204										●			●			0.4	6.35	2.38	2.8
		DCGW11T304													●			0.4	9.525	3.97	4.4
		DCGW11T308													●			0.8	9.525	3.97	4.4
	Medium cutting	PM	DCMT070204-PM	●	●	●	●	●	●	●	●	●	●	●	●			0.4	6.35	2.38	2.8
DCMT070208-PM			●	●	●	●	●	●	●	●	●	●	●	●			0.8	6.35	2.38	2.8	
DCMT11T304-PM			●	●	●	●	●	●	●	●	●	●	●	●			0.4	9.525	3.97	4.4	
DCMT11T308-PM			●	●	●	●	●	●	●	●	●	●	●	●			0.8	9.525	3.97	4.4	
DCMT11T312-PM			●	●	●	●	●	●	●	●	●	●	●	●			1.2	9.525	3.97	4.4	
24		DCMT070202-24													●			0.2	6.35	2.38	2.8
		DCMT070204-24	●	●											●			0.4	6.35	2.38	2.8
		DCMT070208-24		●											●			0.8	6.35	2.38	2.8
		DCMT11T302-24		●											●			0.2	9.525	3.97	4.4
		DCMT11T304-24	●	●											●			0.4	9.525	3.97	4.4
DCMT11T308-24	●	●			●								●			0.8	9.525	3.97	4.4		

● : Line up

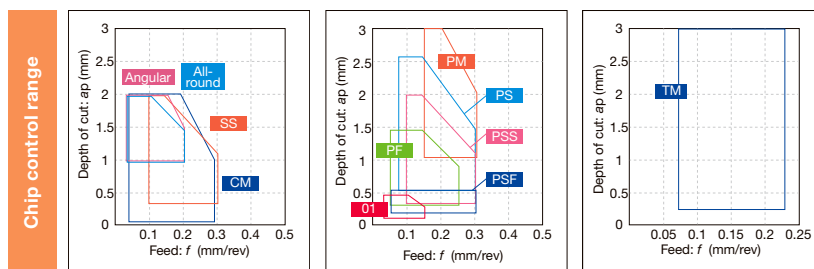

Reference pages: External toolholder → **C046 -** Internal toolholder → **D056 -**
 J-Series toolholder → **G052 -**

Grade
 Insert
 Ext. Toolholder
 Int. Toolholder
 Threading
 Grooving
 Miniature tool
 Milling cutter
 Endmill
 Drilling tool
 Tooling System
 User's Guide
 Index



Insert POSITIVE TYPE

● : Continuous cutting
●● : Light interrupted cutting
✱ : Heavy interrupted cutting

EP



**Rhombic, 75°
with hole
Positive 11°**

P Steel	●●●●●●																			
M Stainless	●●●●●●																			
K Cast iron																				
N Non-ferrous																				
S Superalloy		●●																		
H Hard material																				

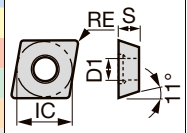

Application	Chipbreaker	Designation	Coated		Dimension (mm)			
			SH725 SH730 J740		RE	IC	S	D1
Finishing (sharp edge)		JS EPGT03X101F-JS	●		<0.1	3.57	1.39	1.9
		EPGT03X102F-JS	●		<0.2	3.57	1.39	1.9
		EPGT03X104F-JS	●		<0.4	3.57	1.39	1.9
		EPGT040101F-JS	●		<0.1	3.97	1.59	2.3
		EPGT040102F-JS	●		<0.2	3.97	1.59	2.3
		EPGT040104F-JS	●		<0.4	3.97	1.59	2.3
Finishing		JS EPGT03X101-JS	●		<0.1	3.57	1.39	1.9
		EPGT03X102-JS	●		<0.2	3.57	1.39	1.9
		EPGT03X104-JS	●		<0.4	3.57	1.39	1.9
		EPGT040101-JS	●		<0.1	3.97	1.59	2.3
		EPGT040102-JS	●		<0.2	3.97	1.59	2.3
		EPGT040104-JS	●		<0.4	3.97	1.59	2.3
Finishing (sharp edge)		J08 EPGT040100FL-J08	●		0.03	3.97	1.59	2.3
		EPGT040102FL-J08	●		0.2	3.97	1.59	2.3
		EPGT040104FL-J08	●		0.4	3.97	1.59	2.3
Finishing		J08 EPGT040100L-J08	●●		0.03	3.97	1.59	2.3
		EPGT040102L-J08	●●		0.2	3.97	1.59	2.3
		EPGT040104L-J08	●●		0.4	3.97	1.59	2.3

*Corner radius (RE) with a sign of inequality (<) means minus tolerance.

● : Line up

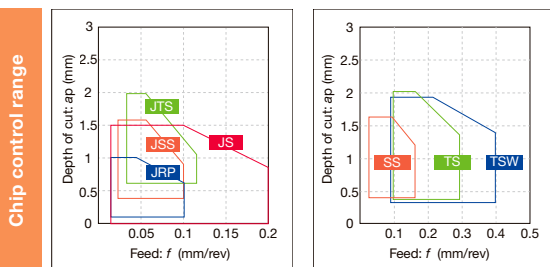

Reference pages: Internal toolholder → **D034** - Boring bar tool → **K201** -
Top-borer tool → **K202**

Insert POSITIVE TYPE

● : Continuous cutting
 ● : Light interrupted cutting
 ✱ : Heavy interrupted cutting

EP



Rhombic, 75°
with hole
Positive 11°

Material	Steel	Stainless	Cast iron	Non-ferrous	Superalloy	Hard material
P	●●●●	●●●●	●●●●	●●●●	●●●●	●●●●
M	●●●●	●●●●	●●●●	●●●●	●●●●	●●●●
K	●●●●	●●●●	●●●●	●●●●	●●●●	●●●●
N	●●●●	●●●●	●●●●	●●●●	●●●●	●●●●
S	●●●●	●●●●	●●●●	●●●●	●●●●	●●●●
H	●●●●	●●●●	●●●●	●●●●	●●●●	●●●●

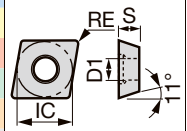

Application	Chipbreaker	Designation	Coated				Coated cermet		Cermet	Uncoated		Dimension (mm)				
			GH110	SH725	SH730		GT9530		NS9530		TH10	UX30	RE	IC	S	D1
Finishing (sharp edge)		W08 EPGT03X100FL-W08	●	●	●							0.03	3.57	1.39	1.9	
		EPGT03X100FR-W08	●	●	●								0.03	3.57	1.39	1.9
		EPGT03X101FL-W08	●	●	●								0.1	3.57	1.39	1.9
		EPGT03X101FR-W08	●	●	●								0.1	3.57	1.39	1.9
		EPGT03X102FL-W08	●	●	●								0.2	3.57	1.39	1.9
		EPGT03X102FR-W08	●	●	●								0.2	3.57	1.39	1.9
		EPGT03X104FL-W08	●	●	●								0.4	3.57	1.39	1.9
		EPGT03X104FR-W08	●	●	●								0.4	3.57	1.39	1.9
		EPGT040100FL-W08	●	●	●								0.03	3.97	1.59	2.3
		EPGT040100FR-W08	●	●	●								0.03	3.97	1.59	2.3
		EPGT040101FL-W08	●	●	●								0.1	3.97	1.59	2.3
		EPGT040101FR-W08	●	●	●								0.1	3.97	1.59	2.3
		EPGT040102FL-W08	●	●	●								0.2	3.97	1.59	2.3
		EPGT040102FR-W08	●	●	●								0.2	3.97	1.59	2.3
		EPGT040104FL-W08	●	●	●								0.4	3.97	1.59	2.3
		EPGT040104FR-W08	●	●	●								0.4	3.97	1.59	2.3
Finishing		W08 EPGT03X100R-W08		●						●		0.03	3.57	1.39	1.9	
		EPGT03X100L-W08		●						●		0.03	3.57	1.39	1.9	
		EPGT03X101R-W08		●							●		0.1	3.57	1.39	1.9
		EPGT03X101L-W08		●							●		0.1	3.57	1.39	1.9
		EPGT03X102R-W08		●							●		0.2	3.57	1.39	1.9
		EPGT03X102L-W08		●							●		0.2	3.57	1.39	1.9
		EPGT03X104R-W08		●							●		0.4	3.57	1.39	1.9
		EPGT03X104L-W08		●							●		0.4	3.57	1.39	1.9
		EPGT040100R-W08		●							●		0.03	3.97	1.59	2.3
		EPGT040100L-W08	●	●					●		●		0.03	3.97	1.59	2.3
		EPGT040101R-W08		●							●		0.1	3.97	1.59	2.3
		EPGT040101L-W08		●							●		0.1	3.97	1.59	2.3
		EPGT040102R-W08	●	●					●		●		0.2	3.97	1.59	2.3
		EPGT040102L-W08	●	●				●	●		●	●	0.2	3.97	1.59	2.3
		EPGT040104R-W08	●	●					●		●		0.4	3.97	1.59	2.3
		EPGT040104L-W08	●	●				●	●		●	●	0.4	3.97	1.59	2.3

● : Line up

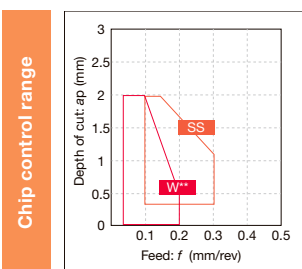

Reference pages: Internal toolholder → **D034** - Boring bar tool → **K201** -
 Top-borer tool → **K202**

Grade
 Insert
 Ext. Toolholder
 Int. Toolholder
 Threading
 Grooving
 Miniature tool
 Milling cutter
 Endmill
 Drilling tool
 Tooling System
 User's Guide
 Index



Insert POSITIVE TYPE

● : Continuous cutting
 ● : Light interrupted cutting
 ❖ : Heavy interrupted cutting

RC



Round,
with hole
Positive 7°

	P	M	K	N	S	H
Steel	● ● ● ❖					
Stainless	● ●		● ●			
Cast iron	● ●		●			
Non-ferrous				● ● ●		
Superalloy				● ● ●		
Hard material						

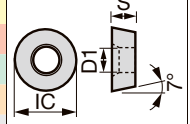

Application	Chipbreaker	Designation	Coated					Cermet	Uncoated	Dimension (mm)				
			T9215	T9225	T5115	AH8005	AH8015	AH905	NS9530	KS05F	RE	IC	S	D1
Finishing		RS RCMT10T3M0-RS	● ●		● ● ●						-	10	3.97	4.4
		RCMT1204M0-RS	● ●		● ● ●						-	12	4.76	4.4
		RCMT1606M0-RS	● ●								-	16	6.35	5.5
		RCMT2006M0-RS	● ●								-	20	6.35	6.5
		RCMT2507M0-RS	● ●								-	25	7.94	7.6
	6RS RCMT1204M0-6RS	● ●					●				-	12	4.76	4.4
Finishing to medium cutting		6RM RCMT1204M0-6RM	● ●				●				-	12	4.76	4.4
		CM RCMT0502M0-CM				●					-	5	2.38	2.5
		RCMT0602M0-CM				●					-	6	2.38	2.8
	RCMT0803M0-CM				●					-	8	3.18	3.4	
Finishing to medium cutting for non-ferrous alloys		AL RCGT0602M0-AL						●			-	6	2.38	2.8
		RCGT0803M0-AL						●			-	8	3.18	3.4
		RCGT1003M0-AL						●			-	10	3.18	4.4

● : Line up

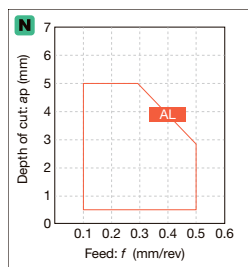
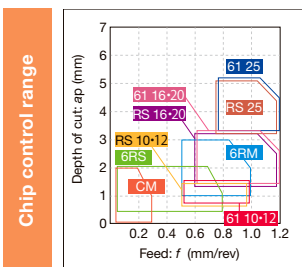

Reference pages: External toolholder → [C056](#) -

Insert POSITIVE TYPE

● : Continuous cutting
 ● : Light interrupted cutting
 ✱ : Heavy interrupted cutting

RC



Round,
with hole
Positive 7°

Material	Steel	Stainless	Cast iron	Non-ferrous	Superalloy	Hard material
P	●●●✱					●●
M	●●	●●●				●●
K	●●		●●●			●●
N				●●●		●●
S					●●●	
H						

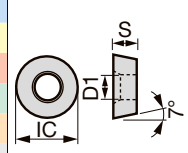

Application	Chipbreaker	Designation	Coated			Cermet	Uncoated	Dimension (mm)			
			T9215	T9225	AH8005 AH8015 AH905	NS9530	TH10	RE	IC	S	D1
Heavy cutting		61 RCMT0502M0-61	●●			●	●	-	5	2.38	2.5
		RCMT0602M0-61	●●			●	●	-	6	2.38	2.8
		RCMT0803M0-61	●●			●	●	-	8	3.18	3.4
		61 RCMM1003M0-61	●●●●●			●	●	-	10	3.18	3.6
		RCMM1204M0-61	●●●●●			●	●	-	12	4.76	4.2
		RCMM1606M0-61	●●				●	-	16	6.35	5.2
RCMM2006M0-61		●				●	-	20	6.35	6.5	
		RCMM2507M0-61	●				-	25	7.94	7.2	

● : Line up

D1 (mm)	Designation	0502M0	0602M0	0803M0	1003M0	1204M0	1606M0	2006M0	2507M0
	RC*T	2.5	2.8	3.4	4.4	4.4	5.5	6.5	7.6
	RCMM	-	-	-	3.6	4.2	5.2	6.5	7.2

RT



Special round
insert

Material	Steel	Stainless	Cast iron	Non-ferrous	Superalloy	Hard material
P	●					
M	●	●●●				
K	●●✱		●●●			
N	●●✱			●●●		
S	●●✱				●●●	
H						

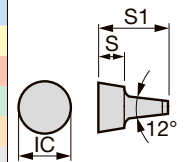

Application	Chipbreaker	Designation	Uncoated		Dimension (mm)			
			TH10	KS20	RE	IC	S	S1
Medium cutting		RT05	●		-	5	2.5	6.5
		RT06	●●		-	6	3	7.7
		RT08	●		-	8	4.2	10.3

● : Line up

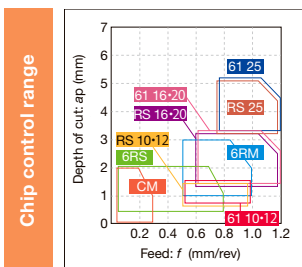

Reference pages: RC...: External toolholder → C056 -

Grade
Insert
Toolholder
Ext. Toolholder
Int. Toolholder
Threading
Threading
Grooving
Miniature tool
Miniature cutter
Milling cutter
Endmill
Drilling tool
Tooling System
User's Guide
Index



Insert POSITIVE TYPE

RC

Round,
without hole
Positive 7°

P	Steel
M	Stainless
K	Cast iron
N	Non-ferrous
S	Superalloy
H	Hard material



Application	Chipbreaker	Designation	Ceramic			Dimension (mm)			
			LX11	TS200	TS300	RE	IC	S	D1
			Medium cutting	-	RCGX090700-E	●	●		-
		RCGX070700-T1	●	●		-	9.525	8	-
		RCGX120700-E	●	●		-	12.7	8	-
		RCGX120700-T1	●	●		-	12.7	8	-
		RCGX090800	●			-	9.525	8	-
		RCGX120800	●			-	12.7	8	-

● : Line up

Edge prep

E: Low cutting force

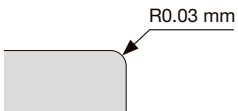

T1: Strong cutting edge

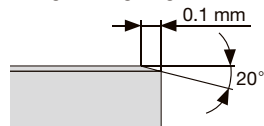

Insert POSITIVE TYPE

SC



Square with hole Positive 7°

Material	Coated	Coated cermet	Cermet	Others
P Steel	●●●✱●		●●	
M Stainless	●●			●●●●●●●●
K Cast iron	●●		●●	
N Non-ferrous				●●●●●●●●
S Superalloy				●●
H Hard material				●●

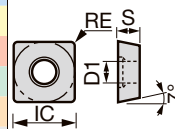

Application	Chipbreaker	Designation	Coated								Coated cermet		Cermet	Dimension (mm)				
			T92T5	T9225	T62T5	T505	T515	T5115	AH6225	AH6235	AH725	AH120	GT9530	AT9530	NS9530	RE	IC	S
Finishing to medium cutting		PS SCMT09T304-PS	●●●					●●●	●●●			●●	●		0.4	9.525	3.97	4.4
		SCMT09T308-PS	●●●					●●●	●●●			●●	●		0.8	9.525	3.97	4.4
		SCMT120404-PS	●●●					●●●	●●●				●		0.4	12.7	4.76	5.5
		SCMT120408-PS	●●●					●●●	●●●				●		0.8	12.7	4.76	5.5
		CM SCMT09T304-CM			●●●										0.4	9.525	3.97	4.4
		SCMT09T308-CM			●●●										0.8	9.525	3.97	4.4
SCMT09T312-CM						●								1.2	9.525	3.97	4.4	
SCMT120404-CM				●●●										0.4	12.7	4.76	5.5	
SCMT120408-CM				●●●										0.8	12.7	4.76	5.5	
Medium cutting		23 SCMT09T302-23										●		0.2	9.525	3.97	4.4	
		SCMT09T308-23		●						●				0.8	9.525	3.97	4.4	
		SCMT120408-23		●					●●					0.8	12.7	4.76	5.5	
		PM SCMT09T304-PM	●●●					●●●	●●●				●		0.4	9.525	3.97	4.4
		SCMT09T308-PM	●●●					●●●	●●●				●		0.8	9.525	3.97	4.4
		SCMT120408-PM	●●●					●●●	●●●				●		0.8	12.7	4.76	5.5
	24 SCMT070204-24		●										●	0.4	7.94	2.38	3.4	
	SCMT09T302-24												●	0.2	9.525	3.97	4.4	
	SCMT09T304-24			●									●	0.4	9.525	3.97	4.4	
	SCMT09T308-24		●●										●	0.8	9.525	3.97	4.4	
	SCMT120404-24		●										●	0.4	12.7	4.76	5.5	
		SCMT120408-24		●									●	0.8	12.7	4.76	5.5	

● : Line up

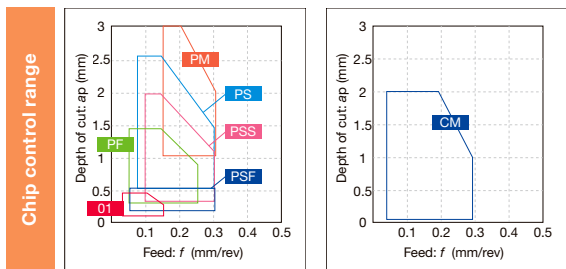

Reference pages: External toolholder → **G079 -**

Insert POSITIVE TYPE

- : Continuous cutting
- ◐ : Light interrupted cutting
- ✱ : Heavy interrupted cutting

SP



Square with hole Positive 11°

	P Steel	M Stainless	K Cast iron	N Non-ferrous	S Superalloy	H Hard material												
●	●	●	●	●	●	●	●	●	●	●	●	●	●	●	●	●	●	●
◐	◐	◐	◐	◐	◐	◐	◐	◐	◐	◐	◐	◐	◐	◐	◐	◐	◐	◐
✱	✱	✱	✱	✱	✱	✱	✱	✱	✱	✱	✱	✱	✱	✱	✱	✱	✱	✱

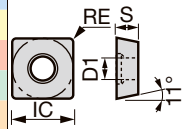

Application	Chipbreaker	Designation	Coated									Coated cermet		Cermet	Uncoated	Dimension (mm)			
			T9215	T9225	T6215	T505	T515	T5115	AH6225	AH6235	AH725	GT9530	AT9530	NS9530	TH10	RE	IC	S	D1
Finishing		W15 SPGT090302L-W15													0.2	9.525	3.18	4.4	
		SPGT090304L-W15													0.4	9.525	3.18	4.4	
		SPGT090308R-W15													0.8	9.525	3.18	4.4	
		SPGT090308L-W15													0.8	9.525	3.18	4.4	
Finishing		W20 SPGT120404L-W20												0.4	12.7	4.76	5.5		
Finishing to medium cutting		PS SPMT090304-PS	●	●	●				●	●	●				0.4	9.525	3.18	4.4	
		SPMT090308-PS	●	●	●				●	●	●				0.8	9.525	3.18	4.4	
		SPMT120404-PS	●	●	●				●	●	●				0.4	12.7	4.76	5.5	
		SPMT120408-PS	●	●	●				●	●	●				0.8	12.7	4.76	5.5	
		CM SPMT090304-CM								●						0.4	9.525	3.18	4.4
		SPMT090308-CM								●						0.8	9.525	3.18	4.4
		SPMT120404-CM				●	●	●								0.4	12.7	4.76	5.5
		SPMT120408-CM				●	●	●								0.8	12.7	4.76	5.5
Finishing to medium cutting		23 SPMT090304-23		●											0.4	9.525	3.18	4.4	
		SPMT090308-23		●												0.8	9.525	3.18	4.4

● : Line up

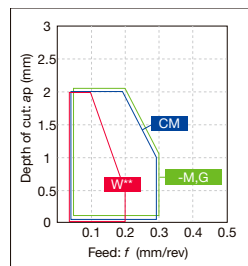
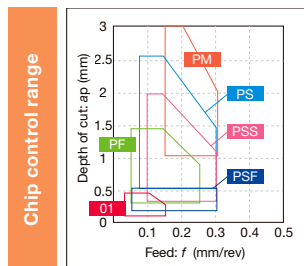

*-M,G: Without chipbreaker

Reference pages: Internal toolholder → **D041 -** Cartridge → **K181 -**

Insert POSITIVE TYPE

● : Continuous cutting
 ●c : Light interrupted cutting
 * : Heavy interrupted cutting

SP



Square with hole
Positive 11°

P	Steel	●c*	●c			●c																
M	Stainless		●c																			
K	Cast iron		●c																			
N	Non-ferrous																					
S	Superalloy																					
H	Hard material																					

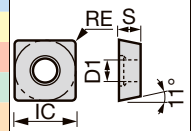

Application	Chipbreaker	Designation	Coated			Cermet	Uncoated	Dimension (mm)			
			T9225	T5115	AH120	NS9530	TH10	RE	IC	S	D1
Finishing to medium cutting	-	SPGM090304L				●		0.4	9.525	3.18	4.4
	(Tungaloy standard hole specification)	SPGM120304L				●		0.4	12.7	3.18	5
		SPGM120308L				●		0.8	12.7	3.18	5
	-	SPMW090304		●				0.4	9.525	3.18	4.4
		SPMW090308		●				0.8	9.525	3.18	4.4
		SPMW120404		●				0.4	12.7	4.76	5.5
		SPMW120408		●				0.8	12.7	4.76	5.5
	-	SPGW090302					●	0.2	9.525	3.18	4.4
		SPGW090304					●	0.4	9.525	3.18	4.4
	SPGW120404					●	0.4	12.7	4.76	5.5	
Medium cutting	-	SPGA090304				●		0.4	9.525	3.18	4.4
	(Tungaloy standard hole specification)										
		SPMT090304-24	●			●		0.4	9.525	3.18	4.4
		SPMT090308-24	●	●		●		0.8	9.525	3.18	4.4
		SPMT120404-24				●		0.4	12.7	4.76	5.5
	SPMT120408-24			●	●		0.8	12.7	4.76	5.5	

● : Line up

Insert POSITIVE TYPE

● : Continuous cutting
 ● : Light interrupted cutting
 ✱ : Heavy interrupted cutting

SP

Square without hole
 Positive 11°

Material	Coated	Cermet	Uncoated	Ceramic
P Steel	●	●	●	●
M Stainless	●	●	●	●
K Cast iron	●	●	●	●
N Non-ferrous	●	●	●	●
S Superalloy	●	●	●	●
H Hard material	●	●	●	●

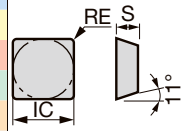

Application	Chipbreaker	Designation	Coated		Cermet	Uncoated		Ceramic		Dimension (mm)					
			T9225	T5115 AH120	NS9530	TH10 UX30	LX10 LX11	RE	IC	S	D1				
Application		SPMR090304-CM	●							0.4	9.525	3.18	-		
		SPMR090308-CM	●							0.8	9.525	3.18	-		
		SPMR120304-CM	●							0.4	12.7	3.18	-		
		SPMR120308-CM	●							0.8	12.7	3.18	-		
		SPMR120312-CM	●							1.2	12.7	3.18	-		
Application		SPMR090304-23			●					0.4	9.525	3.18	-		
		SPMR090308-23	●		●					0.8	9.525	3.18	-		
		SPMR120304-23	●		●					0.4	12.7	3.18	-		
		SPMR120308-23	●		●					0.8	12.7	3.18	-		
Finishing to medium cutting		SPGR090304L			●					0.4	9.525	3.18	-		
		SPGN090304				●		▲		0.4	9.525	3.18	-		
		SPGN090308				●		● ▲		0.8	9.525	3.18	-		
		SPGN090316						● ▲		1.6	9.525	3.18	-		
		SPGN120304				●		● ▲		0.4	12.7	3.18	-		
		SPGN120308				●		● ▲		0.8	12.7	3.18	-		
		SPGN120312			●			● ▲		1.2	12.7	3.18	-		
		SPGN120408				●				0.8	12.7	4.76	-		
		Application		SPMN090304	●							0.4	9.525	3.18	-
				SPMN090308	●							0.8	9.525	3.18	-
SPMN120304	●						●			0.4	12.7	3.18	-		
SPMN120308	●				●		● ●			0.8	12.7	3.18	-		
SPMN120312	●						● ●			1.2	12.7	3.18	-		
SPMN120408	● ●						● ●			0.8	12.7	4.76	-		
SPMN120412	●									1.2	12.7	4.76	-		

● : Line up
 ▲ : To be discontinued

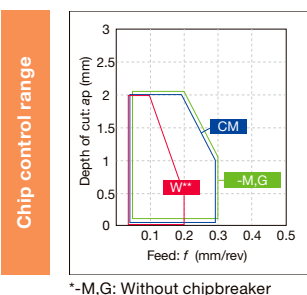

Reference pages: Internal toolholder → D042 - Cartridge → K181 -

Grade
Insert
Ext. Toolholder
Int. Toolholder
Threading
Grooving
Miniature tool
Milling cutter
Endmill
Drilling tool
Tooling System
User's Guide
Index



- Negative
- Positive
- CBN
- PCD
- C
- D
- E
- F
- G
- R
- S
- T
- V
- W
- Y
- OTHERS

Insert POSITIVE TYPE

- : Continuous cutting
- c : Light interrupted cutting
- c* : Heavy interrupted cutting

TC

Triangular with hole Positive 7°



Material	Steel	Stainless	Cast iron	Non-ferrous	Superalloy	Hard material
P	●●c*	●●	●●	●	●	●●c*
M	●●	●	●	●●c*	●●c*	●●c*
K	●●	●	●	●	●	●●c*
N	●	●	●	●●c*	●●c*	●●c*
S	●	●	●	●	●	●●c*
H	●	●	●	●	●	●●c*

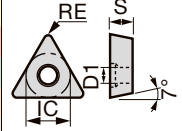

Application	Chipbreaker	Designation	Coated							Coated cermet	Cermets		Uncoated	Dimension (mm)					
			T9215	T9225	T6215	AH8015	AH6225	AH725	SH725	SH730	J740	GT9530	NS9530	NS520	TH10	RE	IC	S	D1
Precision finishing (sharp edge)		JP TCGT110200FN-JP												<0.05	6.35	2.38	2.8		
		TCGT110201FN-JP												<0.1	6.35	2.38	2.8		
		TCGT110202FN-JP													<0.2	6.35	2.38	2.8	
Precision finishing (sharp edge)		01 TCGT110202F-01												<0.2	6.35	2.38	2.8		
		TCGT110204F-01													<0.4	6.35	2.38	2.8	
Precision finishing		01 TCGT090204-01									●	●	0.4	5.56	2.38	2.5			
		TCGT110202-01							●				0.2	6.35	2.38	2.8			
		TCGT110204-01								●	●	●	0.4	6.35	2.38	2.8			
		TCGT110208-01									●		0.8	6.35	2.38	2.8			
		TCGT16T304-01										●	●	0.4	9.525	3.97	4.4		
		TCGT16T308-01										●	●	0.8	9.525	3.97	4.4		
Finishing (sharp edge)		JS TCGT110200FN-JS						●	●					<0.05	6.35	2.38	2.8		
		TCGT110201FN-JS							●	●					<0.1	6.35	2.38	2.8	
		TCGT110202FN-JS								●	●					<0.2	6.35	2.38	2.8
		TCGT110204FN-JS									●	●					<0.4	6.35	2.38
Finishing		JS TCGT110201N-JS						●						0.1	6.35	2.38	2.8		
		TCGT110202N-JS						●						0.2	6.35	2.38	2.8		
		TCGT110204N-JS						●						0.4	6.35	2.38	2.8		
		PSF TCMT090202-PSF							●						0.2	5.56	2.38	2.5	
		TCMT090204-PSF	●	●					●						0.4	5.56	2.38	2.5	
		TCMT110202-PSF							●						0.2	6.35	2.38	2.8	
		TCMT110204-PSF	●	●					●						0.4	6.35	2.38	2.8	
		TCMT110302-PSF							●						0.2	6.35	3.18	2.8	
		TCMT110304-PSF	●	●					●						0.4	6.35	3.18	2.8	
		TCMT16T304-PSF	●	●					●						0.4	9.525	3.97	4.4	
	TSF TCMT110204-TSF	●	●	●										0.4	6.35	2.38	2.8		
	TCMT110208-TSF	●	●	●										0.8	6.35	2.38	2.8		
	TCMT110302-TSF	●	●	●	●	●				●				0.2	6.35	3.18	2.8		
	TCMT110304-TSF	●	●	●	●	●				●				0.4	6.35	3.18	2.8		
	TCMT110308-TSF	●	●	●	●	●				●				0.8	6.35	3.18	2.8		
	TCMT16T304-TSF	●	●	●										0.4	9.525	3.97	4.4		
TCMT16T308-TSF	●	●	●										0.8	9.525	3.97	4.4			

*Corner radius (RE) with a sign of inequality (<) means minus tolerance.

● : Line up

Reference pages: External toolholder → C054 Internal toolholder → D045
 J-Series toolholder → G074 - PINZBOHR® → K178 -

Insert POSITIVE TYPE

- : Continuous cutting
- ◐ : Light interrupted cutting
- ✱ : Heavy interrupted cutting

TC



Triangular with hole Positive 7°

	P	M	K	N	S	H													
Steel	●	◐	◐	◐	◐	◐													
Stainless	◐	◐	◐																
Cast iron	◐	◐	◐																
Non-ferrous																			
Superalloy																			
Hard material																			

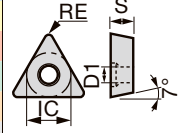

Application	Chipbreaker	Designation	Coated							Coated cermet		Cermet	Uncoated	Dimension (mm)								
			T9215	T9225	T6215	T505	T515	T5115	AH8015	AH6225	AH6235	AH725	GH730	GT9530	AT9530	NS9530	KS05F	RE	IC	S	D1	
Finishing		PSS TCMT090204-PSS	●	●								●						0.4	5.56	2.38	2.5	
		TCMT090208-PSS	●	●								●							0.8	5.56	2.38	2.5
		TCMT110204-PSS	●	●								●							0.4	6.35	2.38	2.8
		TCMT110208-PSS	●	●								●							0.8	6.35	2.38	2.8
		TCMT110304-PSS	●	●								●							0.4	6.35	3.18	2.8
		TCMT110308-PSS	●	●								●							0.8	6.35	3.18	2.8
		TCMT16T304-PSS	●	●								●							0.4	9.525	3.97	4.4
		TCMT16T308-PSS	●	●								●							0.8	9.525	3.97	4.4
		TCMT16T312-PSS	●	●								●							1.2	9.525	3.97	4.4
		PS TCMT090204-PS											●						0.4	5.56	2.38	2.5
		TCMT090208-PS											●						0.8	5.56	2.38	2.5
		TCMT110202-PS	●	●	●							●	●	●					0.2	6.35	2.38	2.8
		TCMT110204-PS	●	●	●							●	●	●					0.4	6.35	2.38	2.8
TCMT110208-PS	●	●	●							●	●	●					0.8	6.35	2.38	2.8		
TCMT110302-PS	●	●	●								●						0.2	6.35	3.18	2.8		
TCMT110304-PS	●	●	●								●						0.4	6.35	3.18	2.8		
TCMT110308-PS	●	●	●								●						0.8	6.35	3.18	2.8		
TCMT16T302-PS	●	●	●								●						0.2	9.525	3.97	4.4		
TCMT16T304-PS	●	●	●								●						0.4	9.525	3.97	4.4		
TCMT16T308-PS	●	●	●								●						0.8	9.525	3.97	4.4		
Finishing to medium cutting		TM TCMT110204-TM	●	●														0.4	6.35	2.38	2.8	
		TCMT110208-TM	●	●														0.8	6.35	2.38	2.8	
		TCMT110302-TM	●	●	●								●					0.2	6.35	3.18	2.8	
		TCMT110304-TM	●	●	●								●					0.4	6.35	3.18	2.8	
		TCMT110308-TM	●	●	●								●					0.8	6.35	3.18	2.8	
		TCMT16T304-TM	●	●														0.4	9.525	3.97	4.4	
		TCMT16T308-TM	●	●														0.8	9.525	3.97	4.4	
Finishing to medium cutting for aluminium cutting		CM TCMT090204-CM																0.4	5.56	2.38	2.5	
		TCMT090208-CM																0.8	5.56	2.38	2.5	
		TCMT110204-CM																0.4	6.35	2.38	2.8	
		TCMT110208-CM																0.8	6.35	2.38	2.8	
		TCMT110304-CM																0.4	6.35	3.18	2.8	
		TCMT110308-CM																0.8	6.35	3.18	2.8	
		TCMT16T304-CM				●	●	●										0.4	9.525	3.97	4.4	
		TCMT16T308-CM				●	●	●										0.8	9.525	3.97	4.4	
TCMT16T312-CM				●	●	●										1.2	9.525	3.97	4.4			
Finishing to medium cutting for aluminium cutting		AL TCGT110202-AL																0.2	6.35	2.38	2.8	
		TCGT110204-AL																0.4	6.35	2.38	2.8	
		TCGT16T302-AL																0.2	9.525	3.97	4.4	
		TCGT16T304-AL																0.4	9.525	3.97	4.4	
		TCGT16T308-AL																0.8	9.525	3.97	4.4	

● : Line up

Reference pages: External toolholder → C054 Internal toolholder → D045
 J-Series toolholder → G074 - PINZBOHR® → K178 -

Insert POSITIVE TYPE

● : Continuous cutting
 ● : Light interrupted cutting
 * : Heavy interrupted cutting

TC



Triangular with hole
Positive 7°

Material	Steel	Stainless	Cast iron	Non-ferrous	Superalloy	Hard material	Coated	Cermet	Uncoated
P	●●●*	●●	●●	●●	●●	●		●●	●
M	●●	●●	●●	●●	●●	●		●●	●●
K	●●	●●	●●	●●	●●	●		●●	●●
N				●●					●●
S					●				
H						●			

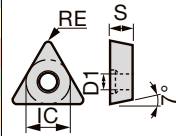

Application	Chipbreaker	Designation	Coated					Cermet	Uncoated	Dimension (mm)				
			T9215	T9225	T6215	AH6225	AH6235	AH725	NS9530	TH10	RE	IC	S	D1
Finishing		SS TCGT110202-SS							●		0.2	6.35	2.38	2.8
		TCGT110204-SS						●		0.4	6.35	2.38	2.8	
		TCGT110208-SS						●		0.8	6.35	2.38	2.8	
		TCGT16T304-SS						●		0.4	9.525	3.97	4.4	
Finishing to medium cutting		23 TCMT090204-23	●					●		0.4	5.56	2.38	2.5	
		TCMT110204-23						●		0.4	6.35	2.38	2.8	
		TCMT16T304-23						●		0.4	9.525	3.97	4.4	
		TCMT16T308-23	●							0.8	9.525	3.97	4.4	
		- TCGT080102R						●	●	0.2	4.76	1.59	2.7	
Medium cutting		PM TCMT110202-PM			●●●●					0.2	6.35	2.38	2.8	
		TCMT110204-PM	●●●●	●●●●	●●●●	●●●●	●		0.4	6.35	2.38	2.8		
		TCMT110208-PM	●●●●	●●●●	●●●●	●●●●	●		0.8	6.35	2.38	2.8		
		TCMT110302-PM			●●●●					0.2	6.35	3.18	2.8	
		TCMT110304-PM			●●●●					0.4	6.35	3.18	2.8	
		TCMT110308-PM			●●●●					0.8	6.35	3.18	2.8	
		TCMT16T304-PM	●●●●	●●●●	●●●●	●●●●	●●●●	●		0.4	9.525	3.97	4.4	
		TCMT16T308-PM	●●●●	●●●●	●●●●	●●●●	●●●●	●		0.8	9.525	3.97	4.4	
		TCMT16T312-PM	●●●●	●●●●	●●●●	●●●●	●●●●			1.2	9.525	3.97	4.4	
		24 TCMT090202-24						●		0.2	5.56	2.38	2.5	
		TCMT090204-24	●●					●		0.4	5.56	2.38	2.5	
		TCMT110202-24						●		0.2	6.35	2.38	2.8	
		TCMT110204-24	●●					●		0.4	6.35	2.38	2.8	
		TCMT110208-24		●●						0.8	6.35	2.38	2.8	
TCMT16T304-24	●●	●●				●		0.4	9.525	3.97	4.4			
TCMT16T308-24	●●	●●			●			0.8	9.525	3.97	4.4			

● : Line up

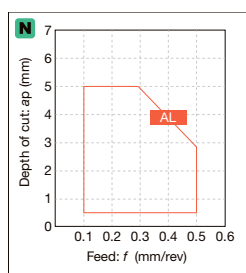
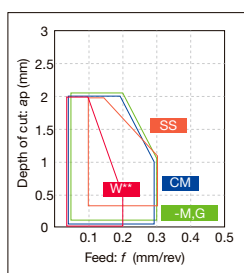
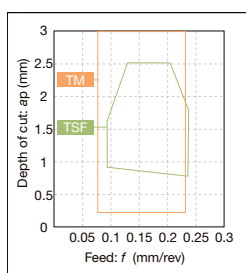
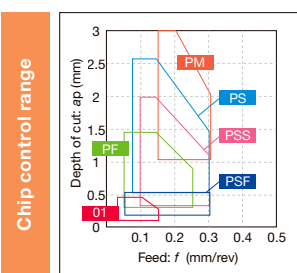

*-M,G: Without chipbreaker

Reference pages: External toolholder → C054 Internal toolholder → D045
 J-Series toolholder → G074 - PINZBOHR® → K178 -

Grade
 Insert
 Ext. Toolholder
 Int. Toolholder
 Threading
 Grooving
 Miniature tool
 Milling cutter
 Endmill
 Drilling tool
 Tooling System
 User's Guide
 Index

Insert POSITIVE TYPE

● : Continuous cutting
 ● : Light interrupted cutting
 ✖ : Heavy interrupted cutting

TP



Triangular with hole
Positive 11°

P	Steel	●●●✖	●	●	●●●●	●●●●	●●●●	●●●●	●													
M	Stainless	●●	●	●	●●●●	●●●●	●●●●	●●●●	●●													
K	Cast iron	●●	●	●	●●●●	●●●●	●●●●	●●●●	●●													
N	Non-ferrous								●													
S	Superalloy		●			●●																
H	Hard material																					

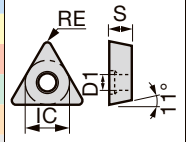

Application	Chipbreaker	Designation	Coated					Coated cermet		Cermet		Uncoated	Dimension (mm)				
			T9215	T9225	AH725	GH730	SH725	SH730	GT9530	GT720	NS9530	NS520	TH10	RE	IC	S	D1
Precision finishing		01 TPGT090202-01						●		●			0.2	5.56	2.38	2.5	
		TPGT090204-01						●		● ●		●	0.4	5.56	2.38	2.5	
		TPGT110202-01						●		●			0.2	6.35	2.38	2.8	
		TPGT110204-01						●		● ●		●	0.4	6.35	2.38	2.8	
		TPGT110208-01								●			0.8	6.35	2.38	2.8	
		TPGT130302-01							●		●			0.2	7.94	3.18	3.4
		TPGT130304-01							●		● ●		●	0.4	7.94	3.18	3.4
		TPGT130308-01									● ●			0.8	7.94	3.18	3.4
		TPGT16T304-01							●		● ●		●	0.4	9.525	3.97	4.4
		TPGT16T308-01								●		● ●		0.8	9.525	3.97	4.4
Finishing (sharp edge)		JS TPGT070101F-JS				●							<0.1	4.37	1.59	2.58	
		TPGT070102F-JS				●							<0.2	4.37	1.59	2.58	
		TPGT070104F-JS				●							<0.4	4.37	1.59	2.58	
Finishing		JS TPGT070101-JS				●							<0.1	4.37	1.59	2.58	
		TPGT070102-JS				●							<0.2	4.37	1.59	2.58	
		TPGT070104-JS				●							<0.4	4.37	1.59	2.58	
		PSF TPMT090202-PSF			●						●			0.2	5.56	2.38	2.5
		TPMT090204-PSF	● ● ●					●		●				0.4	5.56	2.38	2.5
		TPMT110202-PSF			●				●		●			0.2	6.35	2.38	2.8
		TPMT110204-PSF	● ● ●					●		●				0.4	6.35	2.38	2.8
		TPMT110302-PSF			●					●				0.2	6.35	3.18	3.4
		TPMT110304-PSF	● ● ●					●		●				0.4	6.35	3.18	3.4
TPMT130304-PSF	● ● ●					●		●				0.4	7.94	3.18	3.4		
TPMT16T304-PSF	● ● ●					●		●				0.4	9.525	3.97	4.4		
PF		PF TPMT110204-PF			●			●		●			0.4	6.35	2.38	2.8	
		TPMT110208-PF						●		●			0.8	6.35	2.38	2.8	
		TPMT110302-PF			●				●		●			0.2	6.35	3.18	3.4
		TPMT110304-PF			●				●		●			0.4	6.35	3.18	3.4
		TPMT130304-PF							●		●			0.4	7.94	3.18	3.4
		TPMT130308-PF									●			0.8	7.94	3.18	3.4
TPMT16T304-PF							●		●			0.4	9.525	3.97	4.4		

*Corner radius (RE) with a sign of inequality (<) means minus tolerance.

● : Line up

Reference pages: Mounting hole specification → B146
 Internal toolholder → D046 - Cartridge → K181 -
 Boring bar tool → K178 - Top-borer tool → K213

Insert POSITIVE TYPE

- : Continuous cutting
- ◐ : Light interrupted cutting
- ◑ : Heavy interrupted cutting

TP



**Triangular
with hole
Positive 11°**

	P Steel	M Stainless	K Cast iron	N Non-ferrous	S Superalloy	H Hard material														
●	●	●	●	●	●	●	●	●	●	●	●	●	●	●	●	●	●	●	●	●
◐	◐	◐	◐	◐	◐	◐	◐	◐	◐	◐	◐	◐	◐	◐	◐	◐	◐	◐	◐	◐
◑	◑	◑	◑	◑	◑	◑	◑	◑	◑	◑	◑	◑	◑	◑	◑	◑	◑	◑	◑	◑

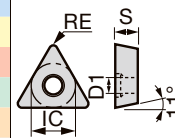

Application	Chipbreaker	Designation	Coated							Coated cermet	Cermet	Uncoated	Dimension (mm)					
			T9215	T9225	T6215	AH8015	AH6225	GH110	SH725	SH730	GT9530	NS9530	TH10	UX30	RE	IC	S	D1
Finishing		TSF TPMT110204-TSF	●	●										0.4	6.35	2.38	2.8	
		TPMT110208-TSF	●	●										0.8	6.35	2.38	2.8	
		TPMT110302-TSF	●	●	●	●	●				●			0.2	6.35	3.18	3.4	
		TPMT110304-TSF	●	●	●	●	●				●			0.4	6.35	3.18	3.4	
		TPMT110308-TSF	●	●	●	●	●				●			0.8	6.35	3.18	3.4	
		TPMT16T304-TSF	●	●											0.4	9.525	3.97	4.4
		TPMT16T308-TSF	●	●											0.8	9.525	3.97	4.4
Finishing (sharp edge)		W08 TPGT070100FR-W08						●						0.03	4.37	1.59	2.58	
		TPGT070100FL-W08						●						0.03	4.37	1.59	2.58	
		TPGT070101FR-W08						●						0.1	4.37	1.59	2.58	
		TPGT070101FL-W08						●						0.1	4.37	1.59	2.58	
		TPGT070102FR-W08						●						0.2	4.37	1.59	2.58	
		TPGT070102FL-W08						●						0.2	4.37	1.59	2.58	
		TPGT070104FR-W08						●						0.4	4.37	1.59	2.58	
		TPGT070104FL-W08						●						0.4	4.37	1.59	2.58	
Finishing		W08 TPGT070100R-W08						●			●			0.03	4.37	1.59	2.58	
		TPGT070100L-W08						●			●			0.03	4.37	1.59	2.58	
		TPGT070101R-W08						●			●			0.1	4.37	1.59	2.58	
		TPGT070101L-W08						●			●			0.1	4.37	1.59	2.58	
		TPGT070102R-W08						●			●			0.2	4.37	1.59	2.58	
		TPGT070102L-W08						●			●			0.2	4.37	1.59	2.58	
		TPGT070104R-W08						●			●			0.4	4.37	1.59	2.58	
		TPGT070104L-W08						●			●			0.4	4.37	1.59	2.58	
		TPGT080200L-W08							●	●					0.03	4.76	2.38	2.3
		TPGT080202L-W08						●		●		●	●		0.2	4.76	2.38	2.3
TPGT080204L-W08						●		●		●	●		0.4	4.76	2.38	2.3		
Finishing		W10 TPGH080202L-W10							●	●				0.2	4.76	2.38	2.3	
		TPGH080204L-W10							●	●				0.4	4.76	2.38	2.3	
		TPGH090204L-W10							●	●				0.4	5.56	2.38	3	

● : Line up

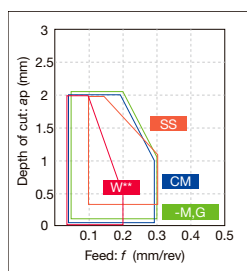
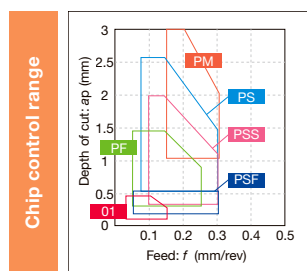

*-M,G: Without chipbreaker

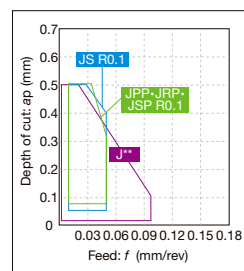
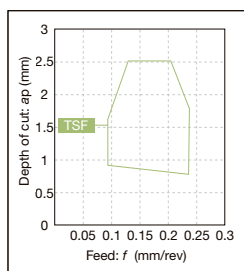

*Chip control range with typical R0.1

Reference pages: Mounting hole specification → **B146**
 Internal toolholder → **D046 -** Cartridge → **K181 -**
 Boring bar tool → **K199 -** Top-borer tool → **K203 -**



Insert POSITIVE TYPE

● : Continuous cutting
● : Light interrupted cutting
✱ : Heavy interrupted cutting

TP



Triangular with hole
Positive 11°

P Steel	● ● ●			● ●		● ●													
M Stainless	● ● ●			● ●		● ●													
K Cast iron	● ● ●			● ●		● ●													
N Non-ferrous																			
S Superalloy	●																		
H Hard material																			

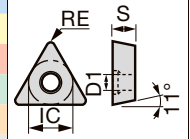

Application	Chipbreaker	Designation	Coated		Coated cermet	Cermet	Uncoated		Dimension (mm)				
			GH110	GH330	GT9530	NS9530	TH10	UX30	RE	IC	S	D1	
W13		TPGH110204L-W13			●	●			0.4	6.35	2.38	3.4	
		TPGH110302L-W13			●	●			0.2	6.35	3.18	3.4	
		TPGH110304L-W13			●	●			0.4	6.35	3.18	3.4	
W15		TPGT090202R-W15				●			0.2	5.56	2.38	2.5	
		TPGT090202L-W15			●	●	●		0.2	5.56	2.38	2.5	
		TPGT090204R-W15				●				0.4	5.56	2.38	2.5
		TPGT090204L-W15	● ●		●	●	● ●			0.4	5.56	2.38	2.5
		TPGT110202R-W15				●				0.2	6.35	2.38	2.8
		TPGT110202L-W15			●	●	●			0.2	6.35	2.38	2.8
		TPGT110204L-W15	● ●		●	●	● ●			0.4	6.35	2.38	2.8
		TPGT110208R-W15				●				0.8	6.35	2.38	2.8
		TPGT110208L-W15						●		0.8	6.35	2.38	2.8
		TPGT110302L-W15				●				0.2	6.35	3.18	3.4
		TPGT110304R-W15					●			0.4	6.35	3.18	3.4
		TPGT110304L-W15					●			0.4	6.35	3.18	3.4
		TPGT110308L-W15					●			0.8	6.35	3.18	3.4
		TPGT130302R-W15				●				0.2	7.94	3.18	3.4
		TPGT130302L-W15			●	●		●		0.2	7.94	3.18	3.4
		TPGT130304R-W15	●			●		●		0.4	7.94	3.18	3.4
		TPGT130304L-W15	● ●		●	●	● ●			0.4	7.94	3.18	3.4
		TPGT130308L-W15				●		●		0.8	7.94	3.18	3.4
		TPGT16T302R-W15					●			0.2	9.525	3.97	4.4
		TPGT16T302L-W15			●	●		●		0.2	9.525	3.97	4.4
TPGT16T304R-W15				●		●		0.4	9.525	3.97	4.4		
TPGT16T304L-W15	● ●		●	●	● ●			0.4	9.525	3.97	4.4		
TPGT16T308L-W15				●		● ●		0.8	9.525	3.97	4.4		
SS		TPGT110202-SS				●			0.2	6.35	2.38	2.8	
		TPGT110204-SS	●			●			0.4	6.35	2.38	2.8	
		TPGT130302-SS				●				0.2	7.94	3.18	3.4
		TPGT130304-SS	●			●				0.4	7.94	3.18	3.4
		TPGT16T304-SS	●			●				0.4	9.525	3.97	4.4

● : Line up

Reference pages: Mounting hole specification → **B146**
 Internal toolholder → **D046 -** Cartridge → **K181 -**
 Top-borer tool → **K203**

Insert POSITIVE TYPE

● : Continuous cutting
 ● : Light interrupted cutting
 ✖ : Heavy interrupted cutting

TP



Triangular with hole
 Positive 11°

Material	Steel	Stainless	Cast iron	Non-ferrous	Superalloy	Hard material
P	●●●✖●	●●●●	●●●●	●●●●	●●●●	●●●●
M	●●●●	●●●●	●●●●	●●●●	●●●●	●●●●
K	●●●●	●●●●	●●●●	●●●●	●●●●	●●●●
N	●●●●	●●●●	●●●●	●●●●	●●●●	●●●●
S	●●●●	●●●●	●●●●	●●●●	●●●●	●●●●
H	●●●●	●●●●	●●●●	●●●●	●●●●	●●●●

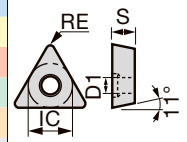

Application	Chipbreaker	Designation	Coated							Coated cermet		Cermet	Dimension (mm)					
			T9215	T9225	T6215	AH8005	AH8015	AH6225	AH6235	AH725	AH120	GH730	GT9530	AT9530	NS9530	RE	IC	S
Finishing to medium cutting		PSS TPMT090204-PSS	●	●	●			●	●	●				●	0.4	5.56	2.38	2.5
		TPMT090208-PSS	●	●	●			●	●	●				●	0.8	5.56	2.38	2.5
		TPMT110204-PSS	●	●	●			●	●	●				●	0.4	6.35	2.38	2.8
		TPMT110208-PSS	●	●	●			●	●	●				●	0.8	6.35	2.38	2.8
		TPMT110304-PSS	●	●	●			●	●	●					0.4	6.35	3.18	3.4
		TPMT110308-PSS	●	●	●			●	●	●					0.8	6.35	3.18	3.4
		TPMT130304-PSS	●	●	●			●	●	●					0.4	7.94	3.18	3.4
		TPMT130308-PSS	●	●	●			●	●	●	●				0.8	7.94	3.18	3.4
		TPMT16T304-PSS	●	●	●			●	●	●					0.4	9.525	3.97	4.4
		TPMT16T308-PSS	●	●	●			●	●	●					0.8	9.525	3.97	4.4
		PS TPMT090202-PS	●	●	●			●	●	●				●	0.2	5.56	2.38	2.5
		TPMT090204-PS	●	●	●			●	●	●				●	0.4	5.56	2.38	2.5
		TPMT090208-PS	●	●	●			●	●	●				●	0.8	5.56	2.38	2.5
		TPMT110202-PS	●	●	●			●	●	●				●	0.2	6.35	2.38	2.8
		TPMT110204-PS	●	●	●			●	●	●	●			●	0.4	6.35	2.38	2.8
		TPMT110208-PS	●	●	●			●	●	●	●			●	0.8	6.35	2.38	2.8
		TPMT110302-PS	●	●	●			●	●					●	0.2	6.35	3.18	3.4
		TPMT110304-PS	●	●	●			●	●	●				●	0.4	6.35	3.18	3.4
		TPMT110308-PS	●	●	●			●	●	●				●	0.8	6.35	3.18	3.4
		TPMT130302-PS	●	●	●			●	●					●	0.2	7.94	3.18	3.4
TPMT130304-PS	●	●	●			●	●	●				●	0.4	7.94	3.18	3.4		
TPMT130308-PS	●	●	●			●	●	●				●	0.8	7.94	3.18	3.4		
TPMT16T304-PS	●	●	●			●	●	●				●	0.4	9.525	3.97	4.4		
TPMT16T308-PS	●	●	●			●	●	●				●	0.8	9.525	3.97	4.4		
	TM TPMT110204-TM	●	●											0.4	6.35	2.38	2.8	
	TPMT110208-TM	●	●											0.8	6.35	2.38	2.8	
	TPMT110302-TM	●	●	●			●	●					●	0.2	6.35	3.18	3.4	
	TPMT110304-TM	●	●	●			●	●					●	0.4	6.35	3.18	3.4	
	TPMT110308-TM	●	●	●			●	●					●	0.8	6.35	3.18	3.4	
	TPMT16T304-TM	●	●											0.4	9.525	3.97	4.4	
	TPMT16T308-TM	●	●											0.8	9.525	3.97	4.4	

● : Line up

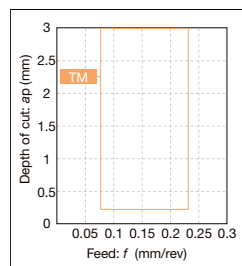
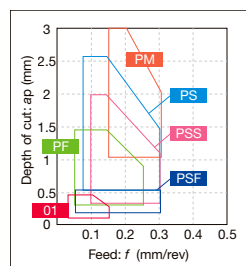
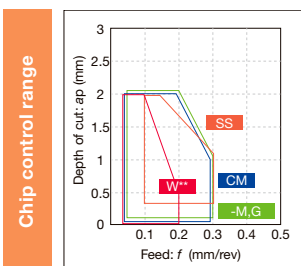

*-M,G: Without chipbreaker

Reference pages: Mounting hole specification → **B146**
 Internal toolholder → **D046 -** Cartridge → **K181 -**
 Boring bar tool → **K199 -** Top-borer tool → **K203**

Insert POSITIVE TYPE

● : Continuous cutting
 ● : Light interrupted cutting
 ✖ : Heavy interrupted cutting

TP



Triangular with hole
 Positive 11°

	P Steel	M Stainless	K Cast iron	N Non-ferrous	S Superalloy	H Hard material
Coated	●✖	●	●	●	●	●
Coated cermet	●	●	●	●	●	●
Cermet	●	●	●	●	●	●
Uncoated	●	●	●	●	●	●

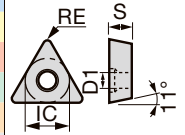

Application	Chipbreaker	Designation	Coated				Coated cermet	Cermet	Uncoated		Dimension (mm)					
			T9225	T505	T515	T5115	GT9530	NS9530	TH10	UX30	RE	IC	S	D1		
Finishing to medium cutting		CM TPMT090204-CM			●						0.4	5.56	2.38	2.5		
		TPMT090208-CM			●						0.8	5.56	2.38	2.5		
		TPMT110204-CM			●						0.4	6.35	2.38	2.8		
		TPMT110208-CM			●						0.8	6.35	2.38	2.8		
		TPMT110304-CM			●						0.4	6.35	3.18	3.4		
		TPMT110308-CM			●						0.8	6.35	3.18	3.4		
		TPMT130304-CM			●						0.4	7.94	3.18	3.4		
		TPMT130308-CM			●						0.8	7.94	3.18	3.4		
		TPMT16T304-CM	●	●	●						0.4	9.525	3.97	4.4		
		TPMT16T308-CM	●	●	●						0.8	9.525	3.97	4.4		
		TPMT16T312-CM	●	●	●						1.2	9.525	3.97	4.4		
		H11 TPGH110302L-H11					●		●			0.2	6.35	3.18	3.4	
		TPGH110304L-H11					●		●			0.4	6.35	3.18	3.4	
		Finishing to medium cutting		23 TPMT090202-23						●			0.2	5.56	2.38	2.5
				TPMT090204-23	●					●			0.4	5.56	2.38	2.5
TPMT110204-23	●								●		0.4	6.35	2.38	2.8		
TPMT130304-23	●								●		0.4	7.94	3.18	3.4		
TPMT130308-23	●								●		0.8	7.94	3.18	3.4		
TPMT16T304-23	●								●		0.4	9.525	3.97	4.4		
TPMT16T308-23	●								●		0.8	9.525	3.97	4.4		
- TPGM070102R									●			0.2	4.37	1.59	2.7	
TPGM070102L									●	●		0.2	4.37	1.59	2.7	
TPGM070104R									●			0.4	4.37	1.59	2.7	
TPGM070104L									●	●		0.4	4.37	1.59	2.7	
TPGM090202R									●			0.2	5.56	2.38	3.2	
TPGM090202L									●			0.2	5.56	2.38	3.2	
TPGM090204L									●			0.4	5.56	2.38	3.2	
(Tungaloy standard hole specification) ISO non-compliant TPGM110202R									●			0.2	6.35	2.38	3	
TPGM110202L							●	●		0.2	6.35	2.38	3			
TPGM110204R							●			0.4	6.35	2.38	3			
TPGM110204L							●	●		0.4	6.35	2.38	3			
TPGM...R/L TPGM110302R							●			0.2	6.35	3.18	3			
TPGM110302L							●			0.2	6.35	3.18	3			
TPGM110302L-2								●		0.2	6.35	3.18	3			
TPGM110304R							●			0.4	6.35	3.18	3			
TPGM110304L							●	●		0.4	6.35	3.18	3			
TPGM110304L-2								●		0.4	6.35	3.18	3			
TPGM160302L							●			0.2	9.525	3.18	4			
TPGM160304R							●			0.4	9.525	3.18	4			
TPGM160304L							●	●		0.4	9.525	3.18	4			
TPGM160304L-2								●		0.4	9.525	3.18	4			

● : Line up

Mounting hole specification	TP*T	TPGM0701	TPGM (A) 0902~1603	TPGH	D1 (mm)							
					0701**	0802**	0902**	1102**	1103**	1303**	1603**	16T3**
					-	2.3	2.5	2.8	3.4	3.4	-	4.4
					2.7	-	3.2	3.0	3.0	-	4.0	-
					-	2.3	3.0	3.4	3.4	-	4.5	-

Insert POSITIVE TYPE

● : Continuous cutting
 ● : Light interrupted cutting
 ✖ : Heavy interrupted cutting

TP



Triangular with hole
Positive 11°

P Steel	●	●	●	✖	●	●	✖	●	●	●	●	●	●	●	●	●	●
M Stainless	●	●	●	●	●	●	●	●	●	●	●	●	●	●	●	●	●
K Cast iron	●	●	●	●	●	●	●	●	●	●	●	●	●	●	●	●	●
N Non-ferrous																	
S Superalloy									●	●	●	●	●	●	●	●	●
H Hard material																	

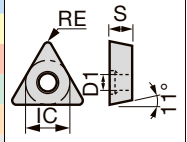

Application	Chipbreaker	Designation	Coated								Coated cermet		Cermet		Uncoated		Dimension (mm)			
			T9215	T9225	T6215	T5115	AH6225	AH6235	AH725	AH120	GH730	GH110	GT9530	NS9530	TH10	UX30	RE	IC	S	D1
Finishing to medium cutting	-	TPMW110204				●										0.4	6.35	2.38	2.8	
		TPMW110208				●										0.8	6.35	2.38	2.8	
		TPMW130304				●										0.4	7.94	3.18	3.4	
		TPMW130308				●										0.8	7.94	3.18	3.4	
		TPMW16T304				●										0.4	9.525	3.97	4.4	
		TPMW16T308				●										0.8	9.525	3.97	4.4	
	(Tungaloy standard hole specification) ISO non-compliant	-	TPGA090204												●		0.4	5.56	2.38	3.2
			TPGA110202											●			0.2	6.35	2.38	3
			TPGA110204												●		0.4	6.35	2.38	3
			TPGA110302												●		0.2	6.35	3.18	3
			TPGA110304												●		0.4	6.35	3.18	3
			TPGA160304												●		0.4	9.525	3.18	4
			TPGA160308												●		0.8	9.525	3.18	4
			-	TPGW090202												●		0.2	5.56	2.38
			TPGW090204												●		0.4	5.56	2.38	2.5
			TPGW110202												●		0.2	6.35	2.38	2.8
	TPGW110204													●		0.4	6.35	2.38	2.8	
	TPGW110304									●				●		0.4	6.35	3.18	3.4	
	TPGW130304													●		0.4	7.94	3.18	3.4	
	TPGW16T304										●			●		0.4	9.525	3.97	4.4	
	TPGW16T308													●		0.8	9.525	3.97	4.4	
Medium cutting	PM	TPMT090204-PM				●	●	●								0.4	5.56	2.38	2.5	
		TPMT090208-PM				●	●	●								0.8	5.56	2.38	2.5	
		TPMT110204-PM	●	●	●	●	●	●		●		●				0.4	6.35	2.38	2.8	
		TPMT110208-PM	●	●	●	●	●	●	●	●		●				0.8	6.35	2.38	2.8	
		TPMT110304-PM	●	●	●	●	●	●	●	●		●		●		0.4	6.35	3.18	3.4	
		TPMT110308-PM	●	●	●	●	●	●	●	●						0.8	6.35	3.18	3.4	
		TPMT130304-PM		●	●	●	●	●	●					●		0.4	7.94	3.18	3.4	
		TPMT130308-PM		●	●	●	●	●	●			●				0.8	7.94	3.18	3.4	
		TPMT16T304-PM		●	●	●	●	●	●					●		0.4	9.525	3.97	4.4	
		TPMT16T308-PM		●	●	●	●	●	●							0.8	9.525	3.97	4.4	
	TPMT16T312-PM		●	●	●	●	●	●							1.2	9.525	3.97	4.4		
24		TPMT090204-24				●								●		0.4	5.56	2.38	2.5	
		TPMT110204-24				●								●		0.4	6.35	2.38	2.8	
		TPMT110208-24												●		0.8	6.35	2.38	2.8	
		TPMT130304-24				●								●		0.4	7.94	3.18	3.4	
		TPMT130308-24				●								●		0.8	7.94	3.18	3.4	
		TPMT16T304-24				●								●		0.4	9.525	3.97	4.4	
	TPMT16T308-24				●								●		0.8	9.525	3.97	4.4		

● : Line up

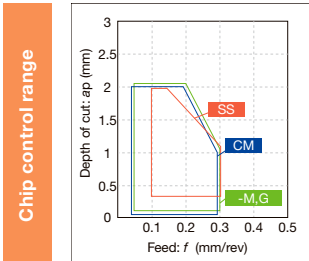

Reference pages: Internal toolholder → **D046 -**
 Cartridge → **K181 -**
 Boring bar tool → **K199 -**

*-M,G: Without chipbreaker

Grade
 Insert
 Ext. Toolholder
 Int. Toolholder
 Threading
 Grooving
 Miniature tool
 Milling cutter
 Endmill
 Drilling tool
 Tooling System
 Tooling Guide
 Index

A
B
C
D
E
F
G
H
I
J
K
L
M

Insert POSITIVE TYPE

● : Continuous cutting
 ● : Light interrupted cutting
 ✳ : Heavy interrupted cutting

TP



Triangular
without hole
Positive 11°

P	Steel	●●●✳	●●●	●●●	●●		●●														
M	Stainless	●●		●●●	●●		●●		●●												
K	Cast iron	●●		●●●	●●		●●		●●												
N	Non-ferrous																				
S	Superalloy			●●	●●																
H	Hard material																				

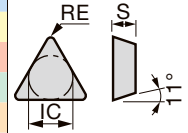

Application	Chipbreaker	Designation	Coated					Cermet	Uncoated		Dimension (mm)			
			T9215	T9225	T5115	AH120	GH110	NS9530	TH10	UX30	RE	IC	S	D1
Finishing to medium cutting		PS TPMR110304-PS	●								0.4	6.35	3.18	-
		TPMR110308-PS	●								0.8	6.35	3.18	-
		TPMR160304-PS	●								0.4	9.525	3.18	-
		TPMR160308-PS	●								0.8	9.525	3.18	-
		CM TPMR110304-CM		●							0.4	6.35	3.18	-
		TPMR110308-CM		●							0.8	6.35	3.18	-
		TPMR160304-CM		●							0.4	9.525	3.18	-
		TPMR160308-CM		●							0.8	9.525	3.18	-
		TPMR160312-CM		●							1.2	9.525	3.18	-
			23 TPMR110304-23	●	●			●				0.4	6.35	3.18
TPMR110308-23				●			●		●		0.8	6.35	3.18	-
TPMR160304-23			●	●			●		●		0.4	9.525	3.18	-
TPMR160308-23			●			●				0.8	9.525	3.18	-	
	- TPGR110302L						●			0.2	6.35	3.18	-	
	TPGR110304L						●			0.4	6.35	3.18	-	
	TPGR160304R						●			0.4	9.525	3.18	-	
	TPGR160304L						●			0.4	9.525	3.18	-	
	TPGR160308L						●			0.8	9.525	3.18	-	
		- TPMN110304			●					●	0.4	6.35	3.18	-
TPMN110308				●					● ●	0.8	6.35	3.18	-	
TPMN160304				● ●					● ●	0.4	9.525	3.18	-	
TPMN160308				● ●					● ●	0.8	9.525	3.18	-	
TPMN160312				●					●	1.2	9.525	3.18	-	
TPMN220408									●	0.8	12.7	4.76	-	
TPMN220412									●	1.2	12.7	4.76	-	

● : Line up

Chip control range

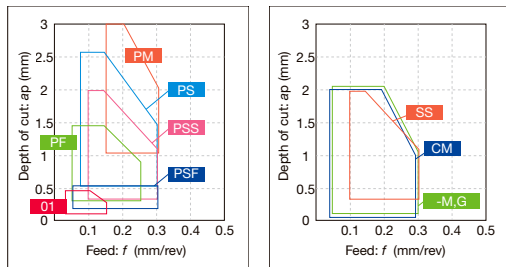

*-M,G: Without chipbreaker

Reference pages: Internal toolholder → **D047 -** Cartridge → **K181 -**

Insert POSITIVE TYPE

- : Continuous cutting
- ◐ : Light interrupted cutting
- ◑ : Heavy interrupted cutting

VB

**Rhombic, 35°
with hole
Positive 5°**



Material	P Steel	M Stainless	K Cast iron	N Non-ferrous	S Superalloy	H Hard material	T9215	T9225	T6215	AH8015	AH6225	AH725	SH725	SH730	J740	GT9530	J9530	NS9530	TH10
P Steel	●	◐	◐	◐	◐	◐	●	◐	◐	◐	◐	◐	◐	◐	◐	◐	◐	◐	◐
M Stainless	◐	◐	◐	◐	◐	◐													
K Cast iron	◐		◐																
N Non-ferrous	◐			◐															
S Superalloy				◐															
H Hard material					◐														

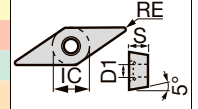

Application	Chipbreaker	Designation	Coated							Coated cermet		Cermet	Uncoated	Dimension (mm)									
			T9215	T9225	T6215	AH8015	AH6225	AH725	SH725	SH730	J740	GT9530	J9530	NS9530	TH10	RE	IC	S	D1				
Precision finishing (sharp edge)		JP VBGT110300FN-JP									●						<0.05	6.35	3.18	2.8			
		VBGT110301FN-JP									●							<0.1	6.35	3.18	2.8		
		VBGT110302FN-JP									●							<0.2	6.35	3.18	2.8		
Finishing (sharp edge)		JS VBGT110300FN-JS										●	●				<0.05	6.35	3.18	2.8			
		VBGT110301FN-JS										●	●				<0.1	6.35	3.18	2.8			
		VBGT110302FN-JS										●	●				<0.2	6.35	3.18	2.8			
		VBGT110304FN-JS											●	●				<0.4	6.35	3.18	2.8		
Finishing		JS VBGT110301N-JS										●						0.1	6.35	3.18	2.8		
		VBGT110302N-JS										●							0.2	6.35	3.18	2.8	
		VBGT110304N-JS										●							0.4	6.35	3.18	2.8	
		PSF VBMT110302-PSF												●		●			0.2	6.35	3.18	2.8	
		VBMT110304-PSF	●	●								●			●				0.4	6.35	3.18	2.8	
		VBMT160402-PSF											●			●			0.2	9.525	4.76	4.4	
		VBMT160404-PSF	●	●								●				●			0.4	9.525	4.76	4.4	
		PF VBMT110302-PF														●		●		0.2	6.35	3.18	2.8
		VBMT110304-PF														●		●		0.4	6.35	3.18	2.8
		VBMT110308-PF							●							●		●		0.8	6.35	3.18	2.8
		VBMT160404-PF														●		●		0.4	9.525	4.76	4.4
VBMT160408-PF														●		●		0.8	9.525	4.76	4.4		
Finishing		TSF VBMT110302-TSF	●	●	●	●	●											0.2	6.35	3.18	2.8		
		VBMT110304-TSF	●	●	●	●	●												0.4	6.35	3.18	2.8	
		VBMT110308-TSF	●	●	●	●	●												0.8	6.35	3.18	2.8	
		VBMT160402-TSF	●	●	●	●	●									●			0.2	9.525	4.76	4.4	
		VBMT160404-TSF	●	●	●	●	●									●			0.4	9.525	4.76	4.4	
		VBMT160408-TSF	●	●	●	●	●									●			0.8	9.525	4.76	4.4	
For external turning on Swiss lathes (sharp edge)		J10 VBGT110300FR-J10											●	●				0.03	6.35	3.18	2.8		
		VBGT110300FL-J10											●	●				0.03	6.35	3.18	2.8		
		VBGT110301FR-J10															●		0.1	6.35	3.18	2.8	
		VBGT110301FL-J10															●		0.1	6.35	3.18	2.8	
		VBGT110302FR-J10															●		0.2	6.35	3.18	2.8	
		VBGT110302FL-J10															●		0.2	6.35	3.18	2.8	
		VBGT110304FR-J10															●		0.4	6.35	3.18	2.8	
		VBGT110304FL-J10															●		0.4	6.35	3.18	2.8	
Finishing		J10 VBGT110302R-J10															●		0.2	6.35	3.18	2.8	
		VBGT110302L-J10															●		0.2	6.35	3.18	2.8	
		VBGT110304R-J10															●		0.4	6.35	3.18	2.8	
		VBGT110304L-J10															●		0.4	6.35	3.18	2.8	

*Corner radius (RE) with a sign of inequality (<) means minus tolerance.

● : Line up

Reference pages: Internal toolholder → **D059 -** J-Series toolholder → **G062 -**

Insert POSITIVE TYPE

- : Continuous cutting
- ◐ : Light interrupted cutting
- ✱ : Heavy interrupted cutting

VB

Rhombic, 35°
with hole
Positive 5°



Material	P Steel	M Stainless	K Cast iron	N Non-ferrous	S Superalloy	H Hard material	Coated	Coated cermet	Cermet	Others
●	●	●	●	●	●	●	●	●	●	●
◐	◐	◐	◐	◐	◐	◐	◐	◐	◐	◐
✱	✱	✱	✱	✱	✱	✱	✱	✱	✱	✱

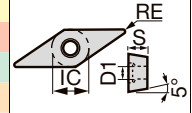

Application	Chipbreaker	Designation	Coated							Coated cermet		Cermet	Dimension (mm)							
			T92T15	T9225	T6215	T505	T515	T5115	AH8005	AH8015	AH6225	AH6235	AH725	AH120	GT9530	AT9530	NS9530	RE	IC	S
Finishing to medium cutting	PSS	VBMT110304-PSS	●	●	●									●			0.4	6.35	3.18	2.8
		VBMT110308-PSS	●	●	●									●			0.8	6.35	3.18	2.8
		VBMT160404-PSS	●	●	●									●			0.4	9.525	4.76	4.4
		VBMT160408-PSS	●	●	●									●			0.8	9.525	4.76	4.4
		VBMT160412-PSS	●	●													1.2	9.525	4.76	4.4
		PS	VBMT110302-PS	●	●	●									●	●		0.2	6.35	3.18
	VBMT110304-PS	●	●	●										●	●		0.4	6.35	3.18	2.8
	VBMT110308-PS	●	●	●										●	●		0.8	6.35	3.18	2.8
	VBMT160402-PS	●	●	●										●	●		0.2	9.525	4.76	4.4
	VBMT160404-PS	●	●	●										●	●		0.4	9.525	4.76	4.4
	VBMT160408-PS	●	●	●										●	●		0.8	9.525	4.76	4.4
	TM	VBMT110302-TM	●	●	●										●		0.2	6.35	3.18	2.8
		VBMT110304-TM	●	●	●										●		0.4	6.35	3.18	2.8
		VBMT110308-TM	●	●	●										●		0.8	6.35	3.18	2.8
		VBMT160402-TM	●	●	●										●		0.2	9.525	4.76	4.4
VBMT160404-TM		●	●	●										●		0.4	9.525	4.76	4.4	
VBMT160408-TM		●	●	●										●		0.8	9.525	4.76	4.4	
CM	VBMT110304-CM															0.4	6.35	3.18	2.8	
	VBMT110308-CM															0.8	6.35	3.18	2.8	
	VBMT160404-CM				●	●	●									0.4	9.525	4.76	4.4	
	VBMT160408-CM				●	●	●									0.8	9.525	4.76	4.4	
	VBMT160412-CM				●	●	●									1.2	9.525	4.76	4.4	
24	VBMT160404-24	●	●											●						
	VBMT160408-24	●	●											●						

● : Line up

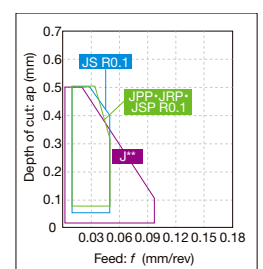
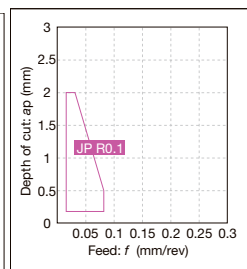
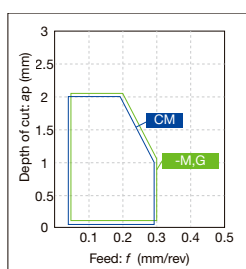
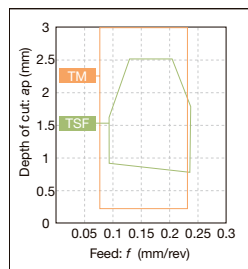
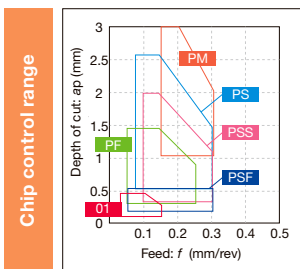

*-M,G: Without chipbreaker

*Chip control range with typical R0.1

Reference pages: Internal toolholder → **D059** - J-Series toolholder → **G062** -

Grade
Insert
Ext. Toolholder
Int. Toolholder
Threading
Grooving
Miniature tool
Milling cutter
Endmill
Drilling tool
Tooling System
User's Guide
Index



Insert POSITIVE TYPE

● : Continuous cutting
● : Light interrupted cutting
✱ : Heavy interrupted cutting

VP

Rhombic, 35°
with hole
Positive 11°

P	Steel	●●●●
M	Stainless	●●●●
K	Cast iron	
N	Non-ferrous	
S	Superalloy	●●
H	Hard material	

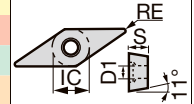

Application	Chipbreaker	Designation	Coated		Dimension (mm)			
			SH725	SH730	RE	IC	S	D1
Finishing (sharp edge)		JPP VPET0802008MFR-JPP	●	●	<0.08*	4.76	2.38	2.3
		VPET0802008MFL-JPP	●		<0.08*	4.76	2.38	2.3
		VPET080201MFR-JPP	●		<0.1*	4.76	2.38	2.3
		VPET080201MFL-JPP	●		<0.1*	4.76	2.38	2.3
		VPET0802018MFR-JPP	●		<0.18*	4.76	2.38	2.3
		VPET0802018MFL-JPP	●		<0.18*	4.76	2.38	2.3
		VPET080202MFR-JPP	●	●	<0.2*	4.76	2.38	2.3
		VPET080202MFL-JPP	●	●	<0.2*	4.76	2.38	2.3
		VPET1103008MFR-JPP	●	●	<0.08*	6.35	3.18	2.8
		VPET110301MFR-JPP	●	●	<0.1*	6.35	3.18	2.8
	VPET110301MFL-JPP	●		<0.1*	6.35	3.18	2.8	
	VPET1103018MFR-JPP	●	●	<0.18*	6.35	3.18	2.8	
	VPET110302MFR-JPP	●	●	<0.2*	6.35	3.18	2.8	
	VPET110302MFL-JPP	●	●	<0.2*	6.35	3.18	2.8	
	JRP VPET0802008MFR-JRP	●	●	<0.08*	4.76	2.38	2.3	
	VPET080201MFR-JRP	●	●	<0.1*	4.76	2.38	2.3	
	VPET080201MFL-JRP	●	●	<0.1*	4.76	2.38	2.3	
	VPET0802018MFR-JRP	●		<0.18*	4.76	2.38	2.3	
	VPET0802018MFL-JRP	●		<0.18*	4.76	2.38	2.3	
	VPET080202MFR-JRP	●	●	<0.2*	4.76	2.38	2.3	
VPET080202MFL-JRP	●	●	<0.2*	4.76	2.38	2.3		
VPET1103008MFR-JRP	●	●	<0.08*	6.35	3.18	2.8		
VPET1103008MFL-JRP	●	●	<0.08*	6.35	3.18	2.8		
VPET110301MFR-JRP	●	●	<0.1*	6.35	3.18	2.8		
VPET110301MFL-JRP	●	●	<0.1*	6.35	3.18	2.8		
VPET1103018MFR-JRP	●	●	<0.18*	6.35	3.18	2.8		
VPET1103018MFL-JRP	●		<0.18*	6.35	3.18	2.8		
VPET110302MFR-JRP	●	●	<0.2*	6.35	3.18	2.8		
VPET110302MFL-JRP	●	●	<0.2*	6.35	3.18	2.8		
	JSP VPET0802008MFN-JSP	●	●	<0.08*	4.76	2.38	2.3	
	VPET080201MFN-JSP	●	●	<0.1*	4.76	2.38	2.3	
	VPET0802018MFN-JSP	●	●	<0.18*	4.76	2.38	2.3	
	VPET080202MFN-JSP	●	●	<0.2*	4.76	2.38	2.3	
	VPET1103008MFN-JSP	●	●	<0.08*	6.35	3.18	2.8	
	VPET110301MFN-JSP	●	●	<0.1*	6.35	3.18	2.8	
	VPET1103018MFN-JSP	●	●	<0.18*	6.35	3.18	2.8	
	VPET110302MFN-JSP	●	●	<0.2*	6.35	3.18	2.8	

*Corner radius (RE) with a sign of inequality (<) means minus tolerance.

● : Line up

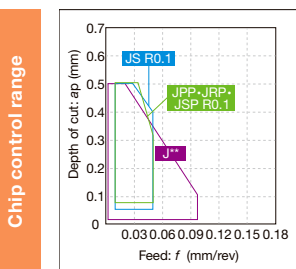

*Chip control range with typical R0.1

Reference pages: J-Series toolholder → G044 -

Insert POSITIVE TYPE / DOUBLE SIDE

- : Continuous cutting
- : Light interrupted cutting
- : Heavy interrupted cutting

VX



Rhombic, 35° with hole

P	●●																				
M	●●																				
K	●●																				
N																					
S																					
H																					

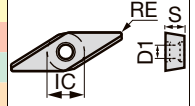

Application	Chipbreaker	Designation	Coated		Dimension (mm)				
			SH725		RE	IC	S	D1	
Finishing (sharp edge)		JRP	VXGU09T201MFRE-JRP**	●		<0.1*	5.56	2.47	2.5
			VXGU09T201MFLE-JRP**	●		<0.1*	5.56	2.47	2.5
			VXGU09T202MFRE-JRP**	●		<0.2*	5.56	2.47	2.5
			VXGU09T202MFLE-JRP**	●		<0.2*	5.56	2.47	2.5
Finishing to medium cutting (sharp edge)		JS	VXGU09T201MFR-JS ⁽¹⁾	●		<0.1*	5.56	2.47	2.5
			VXGU09T201MFL-JS ⁽¹⁾	●		<0.1*	5.56	2.47	2.5
			VXGU09T202MFR-JS ⁽¹⁾	●		<0.2*	5.56	2.47	2.5
			VXGU09T202MFL-JS ⁽¹⁾	●		<0.2*	5.56	2.47	2.5
			VXGU09T204MFR-JS ⁽¹⁾	●		<0.4*	5.56	2.47	2.5
			VXGU09T204MFL-JS ⁽¹⁾	●		<0.4*	5.56	2.47	2.5

*Corner radius (RE) with a sign of inequality (<) means minus tolerance.
 ** For external turning applications
 (1) Due to chipbreaker profile, max ap for face or ID turning is 1 mm

● : Line up

Insert POSITIVE TYPE

WP



Trigon, 80° with hole Positive 11°

P	Steel	●●●																			
M	Stainless	●●	●●																		
K	Cast iron	●●	●●																		
N	Non-ferrous																				
S	Superalloy		●●																		
H	Hard material																				

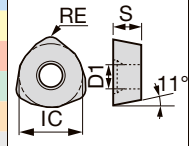

Application	Chipbreaker	Designation	Coated		Dimension (mm)					
			T9215	T9225	AH120	RE	IC	S	D1	
Heavy cutting		ML	WPMT090725ZPR-ML	●	●	●	2.5	15	7	5.5
			WPMT090725ZPL-ML	●	●	●	2.5	15	7	5.5

● : Line up

Grade
Insert
Ext. Toolholder
Int. Toolholder
Threading
Grooving
Miniature tool
Milling cutter
Endmill
Drilling tool
Tooling System
User's Guide
Index



Negative
Positive

Insert POSITIVE TYPE

- : Continuous cutting
- ◐ : Light interrupted cutting
- ✱ : Heavy interrupted cutting

WB

**Trigon, 80°
with hole
Positive 5°**

	P	M	K	N	S	H
Steel	●	◐	◐	◐	◐	◐
Stainless	●	◐	◐	◐	◐	◐
Cast iron	●	◐	◐	◐	◐	◐
Non-ferrous	●	◐	◐	◐	◐	◐
Superalloy	●	◐	◐	◐	◐	◐
Hard material	●	◐	◐	◐	◐	◐

Application	Chipbreaker	Designation	Coated			Cermet	Uncoated		Dimension (mm)			
			GH110	SH725	SH730	NS9530	TH10	UX30	RE	IC	S	D1
Finishing (sharp edge)		JS WBGT030101FR-JS	●						<0.1*	3.97	1.59	2.3
		WBGT030101FL-JS	●						<0.1*	3.97	1.59	2.3
		WBGT030102FR-JS	●						<0.2*	3.97	1.59	2.3
		WBGT030102FL-JS	●						<0.2*	3.97	1.59	2.3
		WBGT030104FR-JS	●						<0.4*	3.97	1.59	2.3
		WBGT030104FL-JS	●						<0.4*	3.97	1.59	2.3
Finishing		JS WBGT030101R-JS		●					<0.1	3.97	1.59	2.3
		WBGT030101L-JS		●					<0.1	3.97	1.59	2.3
		WBGT030102R-JS		●					<0.2	3.97	1.59	2.3
		WBGT030102L-JS		●					<0.2	3.97	1.59	2.3
		WBGT030104R-JS		●					<0.4	3.97	1.59	2.3
		WBGT030104L-JS		●					<0.4	3.97	1.59	2.3
Finishing (sharp edge)		W08 WBGT030100FL-W08	●						0.03	3.97	1.59	2.3
		WBGT030100FR-W08	●						0.03	3.97	1.59	2.3
		WBGT030101FL-W08	●						0.1	3.97	1.59	2.3
		WBGT030101FR-W08	●						0.1	3.97	1.59	2.3
		WBGT030102FL-W08	●						0.2	3.97	1.59	2.3
		WBGT030102FR-W08	●						0.2	3.97	1.59	2.3
		WBGT030104FL-W08	●						0.4	3.97	1.59	2.3
		WBGT030104FR-W08	●						0.4	3.97	1.59	2.3
Finishing		W08 WBGT030100R-W08		●					0.03	3.97	1.59	2.3
		WBGT030100L-W08		●		●	●		0.03	3.97	1.59	2.3
		WBGT030101R-W08		●					0.1	3.97	1.59	2.3
		WBGT030101L-W08		●			●		0.1	3.97	1.59	2.3
		WBGT030102R-W08		●					0.2	3.97	1.59	2.3
		WBGT030102L-W08	●	●		●	●		0.2	3.97	1.59	2.3
		WBGT030104R-W08		●					0.4	3.97	1.59	2.3
		WBGT030104L-W08	●	●		●	●		0.4	3.97	1.59	2.3
Finishing		W11 WBGT060102L-W11	●			●			0.2	3.97	1.59	2.3
		WBGT060104L-W11				●			0.4	3.97	1.59	2.3
		WBGT080202L-W11				●			0.2	4.76	2.38	2.3
		WBGT080204L-W11				●			0.4	4.76	2.38	2.3

*Corner radius (RE) with a sign of inequality (<) means minus tolerance.

● : Line up

Chip control range

*Chip control range with typical R0.1

Reference pages: Internal toolholder → **D052** Top-borer tool → **K203**

B156 tungaloy.com

Insert POSITIVE TYPE / DOUBLE SIDE

- : Continuous cutting
- ◐ : Light interrupted cutting
- ◑ : Heavy interrupted cutting

WX



Trigon, 80° with hole

P	Steel	◐	◑	◐	◑	◐	◑	◐	◑	◐	◑	◐	◑	◐	◑	◐	◑	◐	◑
M	Stainless	◐	◑	◐	◑	◐	◑	◐	◑	◐	◑	◐	◑	◐	◑	◐	◑	◐	◑
K	Cast iron	◐	◑	◐	◑	◐	◑	◐	◑	◐	◑	◐	◑	◐	◑	◐	◑	◐	◑
N	Non-ferrous	◐	◑	◐	◑	◐	◑	◐	◑	◐	◑	◐	◑	◐	◑	◐	◑	◐	◑
S	Superalloy	◐	◑	◐	◑	◐	◑	◐	◑	◐	◑	◐	◑	◐	◑	◐	◑	◐	◑
H	Hard material	◐	◑	◐	◑	◐	◑	◐	◑	◐	◑	◐	◑	◐	◑	◐	◑	◐	◑

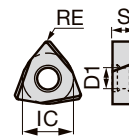

Application	Chipbreaker	Designation	Coated					Coated cermet					Cermet					Uncoated					Dimension (mm)								
			AH725	AH8015	SH725	GT9530	NS9530	KS05F	AH725	AH8015	SH725	GT9530	NS9530	KS05F	AH725	AH8015	SH725	GT9530	NS9530	KS05F	AH725	AH8015	SH725	GT9530	NS9530	KS05F	RE	IC	S	D1	
Finishing to medium cutting (sharp edge)		JTS WXGU040301MFR-JTS			◐																						<0.1*	6.35	3.18	2.7	
		WXGU040301MFL-JTS			◐																						<0.1*	6.35	3.18	2.7	
		WXGU040302MFR-JTS			◐																						<0.2*	6.35	3.18	2.7	
		WXGU040302MFL-JTS			◐																						<0.2*	6.35	3.18	2.7	
Finishing to medium cutting		JTS WXGU040301MR-JTS	◐																								<0.1*	6.35	3.18	2.7	
		WXGU040301ML-JTS	◐																								<0.1*	6.35	3.18	2.7	
		WXGU040302MR-JTS	◐																								<0.2*	6.35	3.18	2.7	
		WXGU040302ML-JTS	◐																								<0.2*	6.35	3.18	2.7	
Finishing to medium cutting		TS WXGU040302R-TS	◐	◐		◐		◐		◐		◐		◐		◐											0.2	6.35	3.18	2.7	
		WXGU040302L-TS	◐	◐		◐		◐		◐		◐		◐		◐											0.2	6.35	3.18	2.7	
		WXGU040304R-TS	◐	◐		◐		◐		◐		◐		◐		◐											0.4	6.35	3.18	2.7	
		WXGU040304L-TS	◐	◐		◐		◐		◐		◐		◐		◐												0.4	6.35	3.18	2.7
		WXGU040308R-TS	◐	◐		◐		◐		◐		◐		◐		◐												0.8	6.35	3.18	2.7
WXGU040308L-TS	◐	◐		◐		◐		◐		◐		◐		◐												0.8	6.35	3.18	2.7		

*Corner radius (RE) with a sign of inequality (<) means minus tolerance.

● : Line up

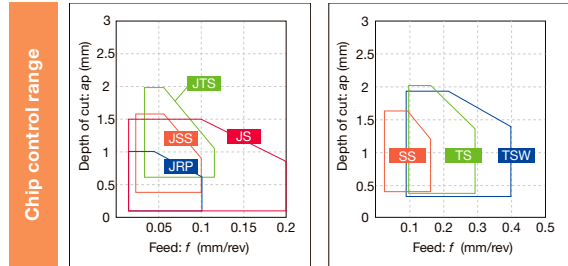

Reference pages: External toolholder → C029 -, Internal toolholder → D023
 J-Series toolholder → G045 -

Insert POSITIVE TYPE

● : Continuous cutting
 ● : Light interrupted cutting
 ✱ : Heavy interrupted cutting

YW

Rhombic, 25°
with hole
Positive 7°



Material	Steel	Stainless	Cast iron	Non-ferrous	Superalloy	Hard material
P	●●✱	●	●	●	●	●
M	●●	●	●	●	●	●
K	●●	●	●	●	●	●
N	●	●	●	●	●	●
S	●	●	●	●	●	●
H	●	●	●	●	●	●

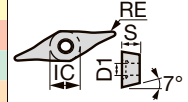

Application	Chipbreaker	Designation	Coated		Coated cermet	Cermet	Dimension (mm)						
			T9215	T9225	T6215	AH8015	AH6225	GT9530	NS9530	RE	IC	S	D1
Finishing to medium cutting		ZF	YWMT11T202-ZF	●	●	●	●	●	●	0.2	4.679	2.78	2.3
			YWMT11T204-ZF	●	●	●	●	●	●	0.4	4.679	2.78	2.3
			YWMT16T302-ZF	●	●	●	●	●	●	0.2	7.018	3.97	2.86
			YWMT16T304-ZF	●	●	●	●	●	●	0.4	7.018	3.97	2.86
			YWMT16T308-ZF	●	●	●	●	●	●	0.8	7.018	3.97	2.86
		ZM	YWMT11T202-ZM	●	●	●	●	●	●	●	0.2	4.679	2.78
	YWMT11T204-ZM	●	●	●	●	●	●	●	0.4	4.679	2.78	2.3	
	YWMT16T302-ZM	●	●	●	●	●	●	●	0.2	7.018	3.97	2.86	
	YWMT16T304-ZM	●	●	●	●	●	●	●	0.4	7.018	3.97	2.86	
	YWMT16T308-ZM	●	●	●	●	●	●	●	0.8	7.018	3.97	2.86	

● : Line up

JXF

Front turning



Material	Steel	Stainless	Cast iron	Non-ferrous	Superalloy	Hard material
P	●●	●	●	●	●	●
M	●●	●	●	●	●	●
K	●●	●	●	●	●	●
N	●	●	●	●	●	●
S	●	●	●	●	●	●
H	●	●	●	●	●	●

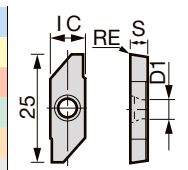

Application	Chipbreaker	Designation	Coated	Uncoated	Dimension (mm)			
			J740	TH10	RE	IC	S	D1
Front turning		JXFR8000F	●	●	0.03	8	3.97	4.4
		JXFR8010F	●	●	0.1	8	3.97	4.4

● : Line up

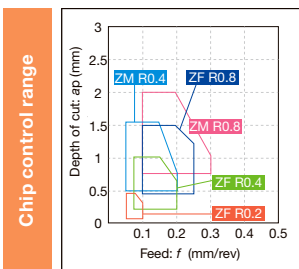

Reference pages: YWMT...: External toolholder → C049 - Internal toolholder → D064 -
 JXF...: J-Series toolholder → G088 -

Grade
Insert
Toolholder
Ext. Toolholder
Int. Toolholder
Threading
Grooving
Miniature tool
Milling cutter
Endmill
Drilling tool
Tooling System
User's Guide
Index



Insert POSITIVE TYPE

- : Continuous cutting
- ◐ : Light interrupted cutting
- ✱ : Heavy interrupted cutting

JXR



Reverse turning

P Steel	●◐	●																					
M Stainless	●◐	●																					
K Cast iron	●◐	●																					
N Non-ferrous		●																					
S Superalloy																							
H Hard material																							

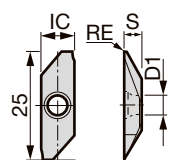

Application	Chipbreaker	Designation	Coated		Uncoated		Dimension (mm)			
			J740		TH10		RE	IC	S	D1
Reverse turning	-	JXRR8000F	●		●		0.03	8	3.97	4.4
		JXRR8010F	●		●		0.1	8	3.97	4.4



JXB



Back turning

P Steel	●◐	●																					
M Stainless	●◐	●																					
K Cast iron	●◐	●																					
N Non-ferrous		●																					
S Superalloy																							
H Hard material																							

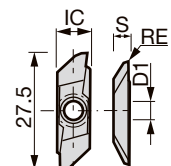

Application	Chipbreaker	Designation	Coated		Uncoated		Dimension (mm)			
			J740		TH10		RE	IC	S	D1
Back turning	-	JXBR8000F	●		●		0.03	8	3.97	4.4
		JXBL8000F	●		●		0.03	8	3.97	4.4
		JXBR8005F	●		●		0.05	8	3.97	4.4
		JXBL8005F	●		●		0.05	8	3.97	4.4
		JXBR8005	●				0.05	8	3.97	4.4
		JXBL8005	●				0.05	8	3.97	4.4
		JXBR8010F	●		●		0.10	8	3.97	4.4
		JXBL8010F	●		●		0.10	8	3.97	4.4
		JXBR8010	●				0.10	8	3.97	4.4
		JXBL8010	●				0.10	8	3.97	4.4
		JXBR8015F	●		●		0.15	8	3.97	4.4
		JXBL8015F	●		●		0.15	8	3.97	4.4
		JXBR8015	●				0.15	8	3.97	4.4
		JXBL8015	●				0.15	8	3.97	4.4



● : Line up

Insert POSITIVE TYPE

- : Continuous cutting
- ◐ : Light interrupted cutting
- ◑ : Heavy interrupted cutting

JTB*



Back turning

	P Steel	M Stainless	K Cast iron	N Non-ferrous	S Superalloy	H Hard material
●	●●●	●●●	●●	●●	●●	●
◐	●●●	●●●	●●	●●	●●	●
◑	●●●	●●●	●●	●●	●●	●

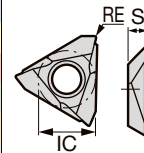

Application	Chipbreaker	Designation	Coated		Coated cermet	Cermet	Uncoated	Dimension (mm)			
			SH725	J740	J9530	NS9530	TH10	RE	IC	S	D1
Back turning	-	JTBR3000F	●	●			●	0.03	9.5	3.18	4.4
		JTBL3000F	●	●			●	0.03	9.5	3.18	4.4
		JTBR3005F	●	●			●	0.05	9.5	3.18	4.4
		JTBL3005F	●	●			●	0.05	9.5	3.18	4.4
		JTBR3005		●	●			0.05	9.5	3.18	4.4
		JTBL3005		●				0.05	9.5	3.18	4.4
		JTBR3010F	●	●		●	●	0.10	9.5	3.18	4.4
		JTBL3010F	●	●		●	●	0.10	9.5	3.18	4.4
		JTBR3010		●	●			0.10	9.5	3.18	4.4
		JTBL3010		●				0.10	9.5	3.18	4.4
		JTBR3015F	●	●				0.15	9.5	3.18	4.4
		JTBL3015F	●					0.15	9.5	3.18	4.4

J10E*



Back turning

	P Steel	M Stainless	K Cast iron	N Non-ferrous	S Superalloy	H Hard material
●	●●●	●●●	●●	●●	●●	●
◐	●●●	●●●	●●	●●	●●	●
◑	●●●	●●●	●●	●●	●●	●

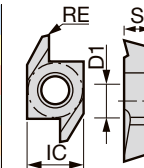

Application	Chipbreaker	Designation	Coated		Coated cermet	Cermet	Uncoated	Dimension (mm)			
			SH725	J740	J9530	NS9530	TH10	RE	IC	S	D1
Back turning	-	J10ER005BF	●	●		●	●	0.05	6.35	3.18	3.0
		J10EL005BF	●	●			●	0.05	6.35	3.18	3.0
		J10ER005B		●	●			0.05	6.35	3.18	3.0
		J10EL005B		●				0.05	6.35	3.18	3.0
		J10ER010BF	●	●		●	●	0.10	6.35	3.18	3.0
		J10EL010BF	●	●			●	0.10	6.35	3.18	3.0
		J10ER010B		●	●			0.10	6.35	3.18	3.0
		J10EL010B		●				0.10	6.35	3.18	3.0
		J10EL015BF	●					0.15	6.35	3.18	3.0
		J10ER015BF	●					0.15	6.35	3.18	3.0

● : Line up

Reference pages: JTB...: J-Series toolholder → [G083](#) J10E...: J-Series toolholder → [G089](#)

Grade
Insert
Toolholder
Ext. Toolholder
Int. Toolholder
Threading
Grooving
Miniature tool
Milling cutter
Endmill
Drilling tool
Tooling System
User's Guide
Index



Insert POSITIVE TYPE

- : Continuous cutting
- ◐ : Light interrupted cutting
- ✱ : Heavy interrupted cutting

10E*



Back turning

P	Steel	●
M	Stainless	●
K	Cast iron	●
N	Non-ferrous	●
S	Superalloy	●
H	Hard material	●

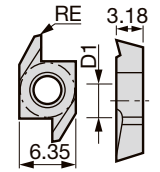

Application	Chipbreaker	Designation	Uncoated										Dimension (mm)						
			TH10											RE	IC	S	D1		
Back turning	-	10ER100B	●													0.03	6.35	3.18	3.0
		10EL100B	●													0.03	6.35	3.18	3.0
		10ER150B	●													0.03	6.35	3.18	3.0
		10EL150B	●													0.03	6.35	3.18	3.0
		10ER300	●													-	6.35	3.18	3.0
		10EL300	●													-	6.35	3.18	3.0

● : Line up

MEMO

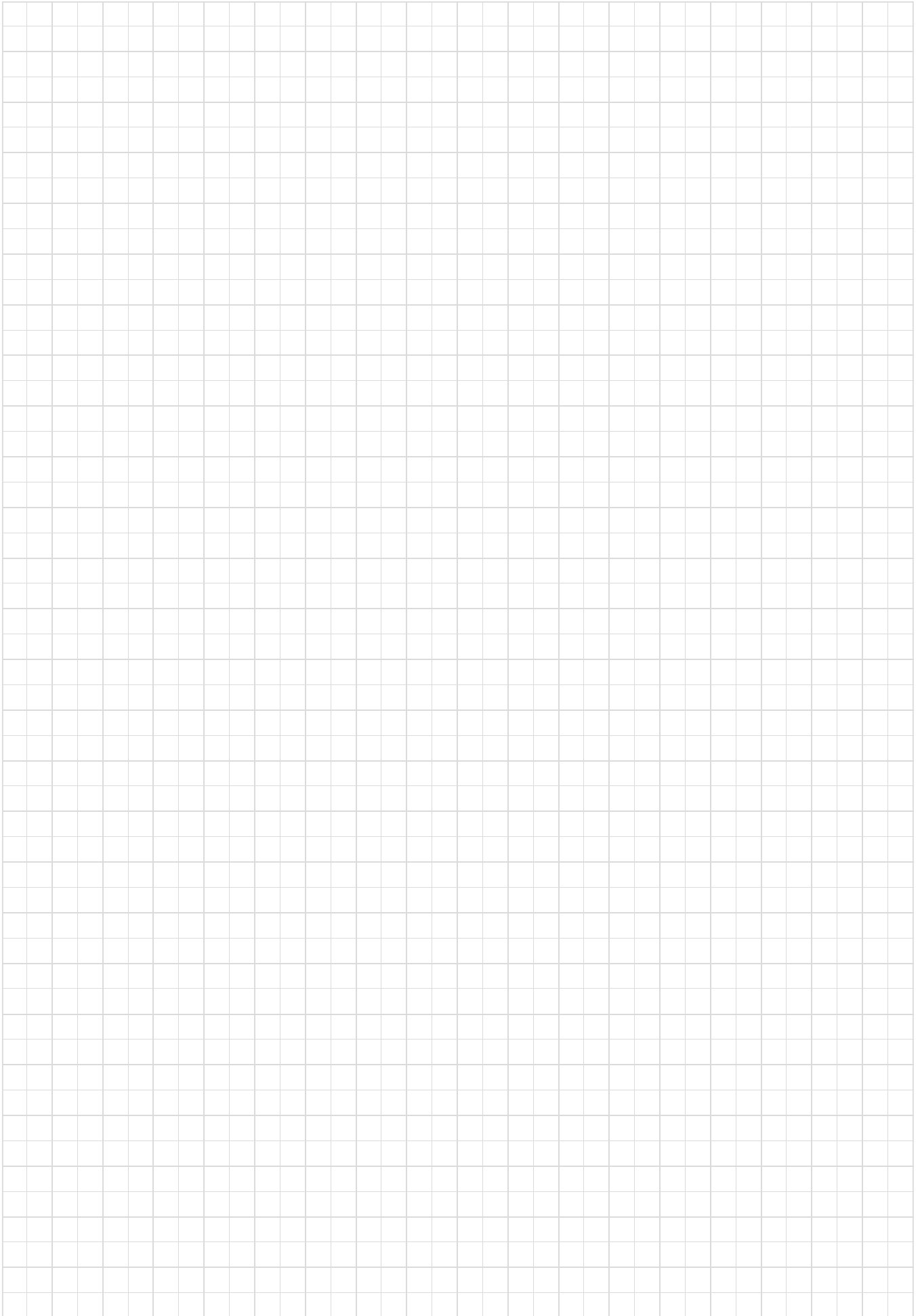

Grade

A

Insert

B

Ext. Toolholder

C

Int. Toolholder

D

Threading

E

Grooving

F

Miniature tool

G

Milling cutter

H

Endmill

I

Drilling tool

J

Tooling System

K

User's Guide

L

Index

M

BXA10 / BXA20 / BR35F

Coated CBN series for a wide range of hard part turning

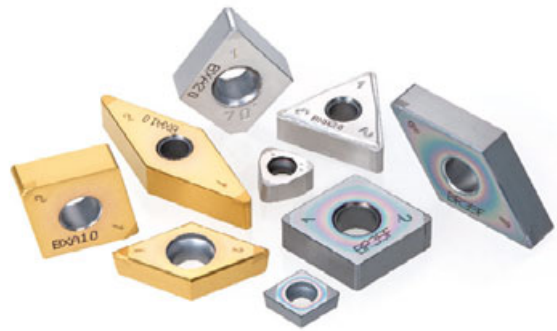

■ Application areas

The most suitable grade can be selected for your application requirements

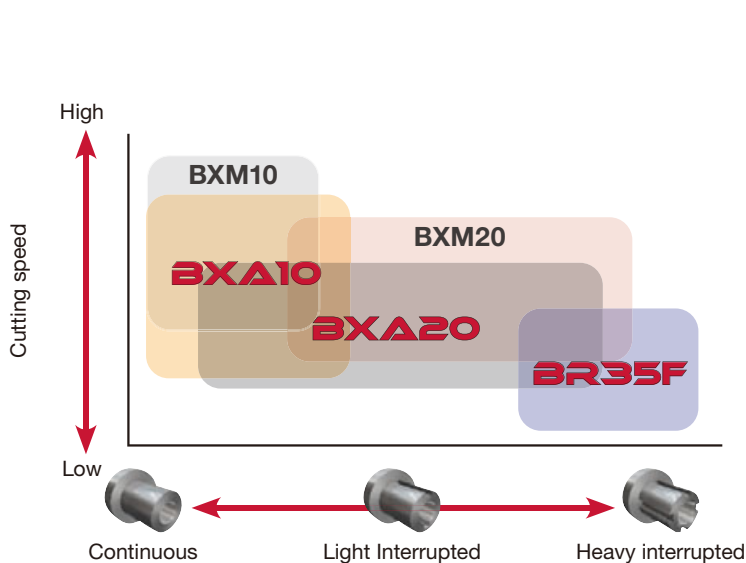

BXA10

- First choice for continuous to light interrupted cuts
- For $V_c = 230$ m/min or less



BXA20

- Versatile grade from continuous to heavy interrupted cuts
- For $V_c = 180$ m/min or less



BR35F

- First choice for heavy interrupted cuts
- For $V_c = 150$ m/min or less

BXM10

- Complementary grade for continuous to light interrupted cuts
- For extremely high cutting speeds of $V_c = 300$ m/min

BXM20

- Complementary versatile grade for continuous to heavy interrupted cuts
- For high cutting speeds of $V_c = 200$ m/min

■ Grade properties

BXA10

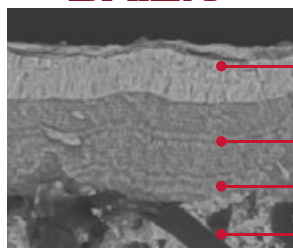

- TiCN coating with high thermal stability and wear resistance
- Multilayer TiAlN coating with good adhesion and resistance to delamination and chipping
- Strong coating-substrate adhesion prevents delamination
- Dedicated CBN substrate with excellent flank wear and crater wear resistance

BXA20

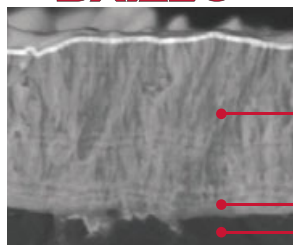

- Thick multilayer TiAlN coating with superior wear and chipping resistance
- Strong coating-substrate adhesion prevents delamination
- Dedicated CBN substrate with excellent crater wear and fracture resistance

BR35F



- Multilayer AlCrN coating with excellent fracture resistance
- Strong coating-substrate adhesion prevents delamination
- Dedicated CBN substrate with excellent chipping and fracture resistance

WavyJoint

New brazing technology for increased machining efficiency

A maximum depth of cut up to 0.8 mm.
Reduces the number of passes to increase productivity.

Innovative WavyJoint brazing technology

Prevents the CBN tips from debrazing, eliminating abrupt insert fractures during demanding dry machining, while securing stable and predictable hard turning operations.

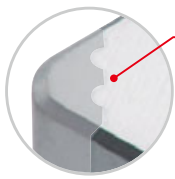

The "wavy" contact surface enhances the brazing strength

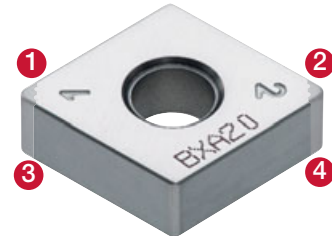

Double sided inserts

WavyJoint

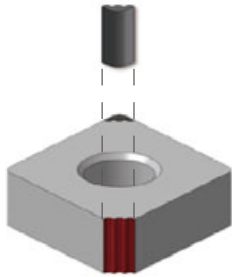

Vs.

Standard

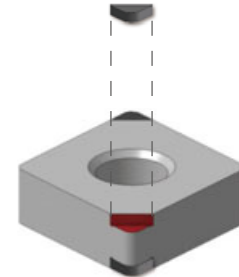

CBN Tip Size: 200% larger for improved wear resistance of the cutting edge

Brazing Area: 160% larger for enhanced brazing strength

MINIFORCE

Double-sided positive insert with CBN tips

MiniForce-Turn now offers WavyJoint CBN inserts that provide additional strength and security in aggressive cutting conditions.

■ WXGQ0403... insert

Double-sided positive inserts



6-edged insert with dovetail design

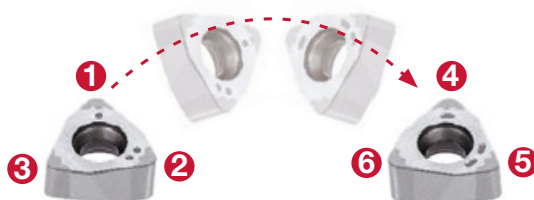

Grade
Insert
Ext. Toolholder
Int. Toolholder
Threading
Grooving
Miniature tool
Milling cutter
Endmill
Drilling tool
Tooling System
User's Guide
Index



HARDBREAKER SERIES

CBN inserts with chipbreaker ideal for carburized layer removal and finishing hardened steel

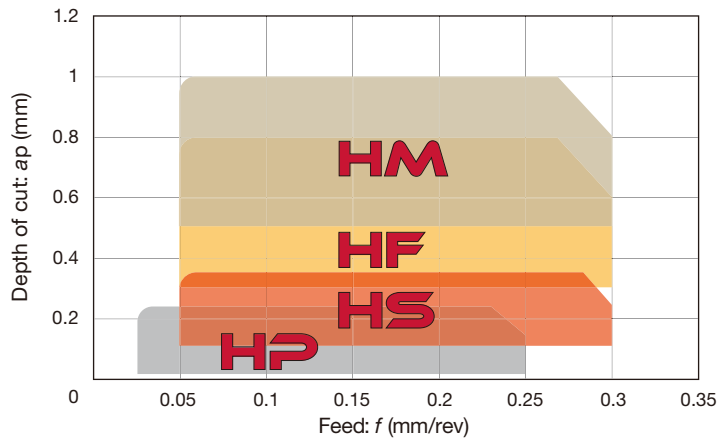

IHS chipbreaker

Optimized chipbreaker design for excellent chip control during hard turning at aggressive conditions

- Designed for high feed machining.
- Provides excellent chip control for a wide range of D.O.C. and feed rates.
- Edge preparation is designed to prevent catastrophic failure.

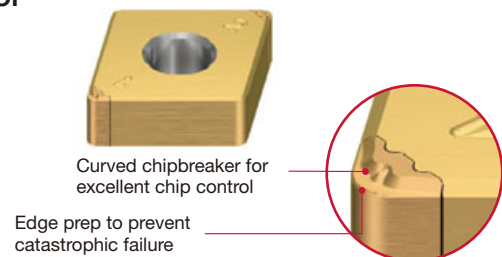

IHP chipbreaker

Designed for finish machining of hardened parts with close tolerances

- Optimized chipbreaker geometry significantly reduces cutting force imposed on the cutting edge, ensuring long tool life.
- The edge preparation is designed to generate low cutting force, providing chatter-free machining and close tolerances.
- The built-in wiper yields excellent surface quality and good chip control.

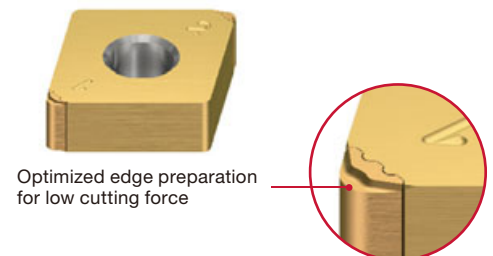

IHF and HM chipbreaker

- Suited for hard turning applications requiring great D.O.C. such as carburized layer removal.
- Effective chip breaking is possible for a wide range of hard materials.
- **BXA20** and **BXM20** CBN grade inserts are available for aggressive cutting depths.

■ Edge preparations

Various styles of edge preparations are available according to the application needs

BXA10 and BXA20 grade ISO inserts are available in five different styles of edge preps: L, LF, LC, standard and -H; BR35F grade ISO inserts are offered in two styles of edge preps: SR and HC.

*For the new BR35F grade ISO inserts, "SR" is assigned for the edge prep symbol for S01325, instead of "Standard" as previously assigned. Likewise, "HC" for S01835, instead of conventional "H".

MiniForce-Turn inserts are available in the SP style edge prep (S01310).

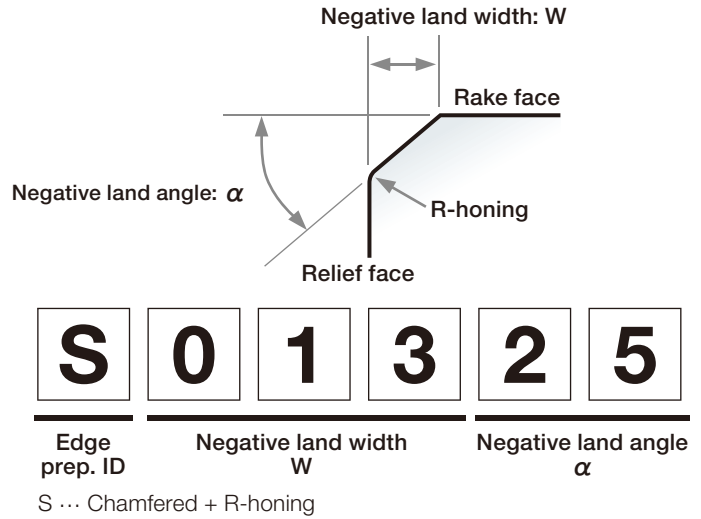
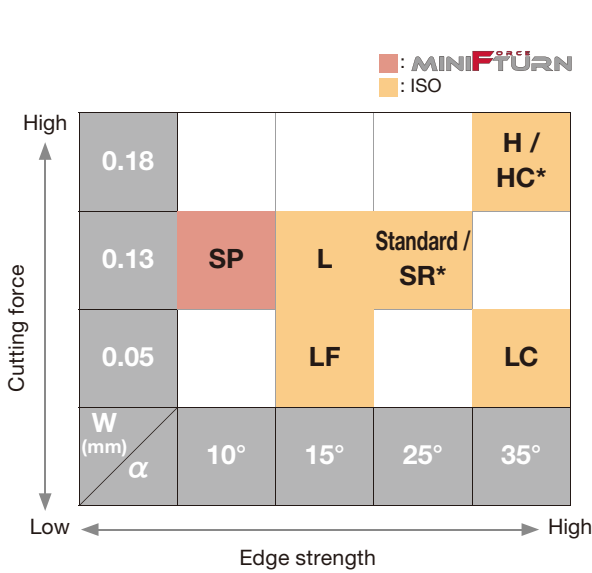

*Edge prep symbol for BR35F grade inserts only

Non-Ferrous Application Series

Complete turning solutions for non-ferrous materials



■ PCD inserts with 3D chipbreaker

NS chipbreaker

No more chip nesting in aluminum alloy machining

Unique 3D chipbreaker

- Versatile geometry allows excellent chip control
- One insert handles from rough to finish operations
- Optimal rake angle design effectively directs chips to the redirector

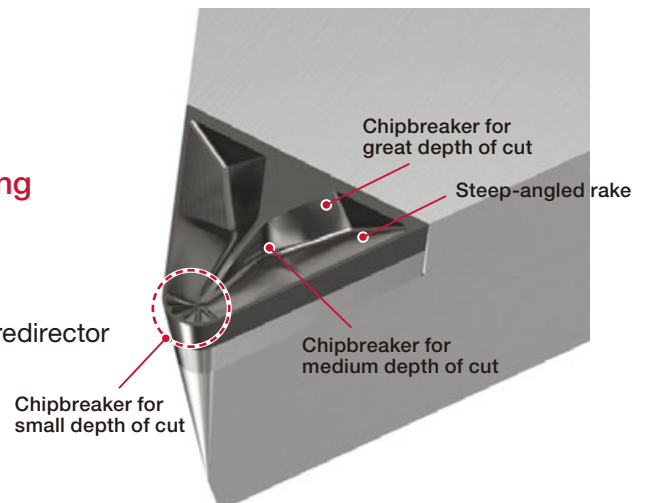

CN



80° Rhombic with hole

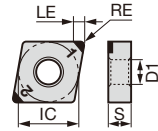

IC : 12.7 mm
 DT : 5.16 mm
 S : 4.76 mm

K	Cast iron																					
S	Superalloy																					
H	●	●◐	●✱	●	●◐	●✱	●	●◐	●	●◐	●	●◐	●✱	●	●◐	●✱	●	●◐	●✱	●	●◐	●✱
Sintered metal																						

Application	Designation	Dimension (mm)				Problem																					
		RE	LE	No. of corners	Wiper	Standard	Burr	Flnak wear	Crater wear	Chipping	BXA10	BXA20	BR35F	BXM10	BXM20	BXC50	BXA30	BXA40	BX310	BX330	BX360	BX380	BX470	BX480	BX815	BX930	
Precision finishing	2QP-CNGA120402-LF	0.2	2.3	2			○			●	●																
	2QP-CNGA120402-L		2.3	2				○			●	●															
	2QP-CNGA120404F		2.3	2			○																	●			
	2QP-CNGA120404-E		2.3	2		○																					●
	2QP-CNGA120404-LT		2.3	2					○																		●
	2QP-CNGA120404-LF		2.3	2			○				●	●															●
	4QS-CNGA120404-LF	0.4	1.6	4			○				●	●															
	2QP-CNGA120404-L		2.3	2				○			●	●		●	●						●						
	2QP-CNGA120404WL		2.3	2	○	○					●	●		●	●						●						●
	4QS-CNGA120404WL		1.6	4	○	○					●	●															
	2QP-CNMA120404W		2.3	2	○	○															●						
	4QP-CNMA120404W		2.3	4	○	○										●											
	2QP-CNGA120408F	0.8	2.2	2			○																		●		
	2QP-CNGA120408-E		2.2	2																							●
	2QP-CNGA120408-LT		2.2	2																							●
	2QP-CNGA120408-LF		2.2	2			○					●	●														
	4QS-CNGA120408-LF		1.5	4			○					●	●		●	●						●					
	2QP-CNGA120408-L		2.2	2				○				●	●		●	●						●					
	2QP-CNGA120408WL		2.2	2	○	○						●	●		●	●											
	4QS-CNGA120408WL		1.8	4	○	○						●	●														
2QP-CNMA120408W	2.2		2	○	○																●						
4QP-CNMA120408W	2.2		4	○	○											●											
2QP-CNGA120412-E	1.2		2.4	2																						●	
2QP-CNGA120412-LT			2.4	2																						●	
2QP-CNGA120412-LF			2.4	2			○					●	●														
4QS-CNGA120412-LF			1.7	4			○					●	●														
2QP-CNGA120412-L			2.4	2				○				●	●		●	●						●					
2QP-CNGA120412WL			2.4	2	○	○						●	●		●	●											
4QS-CNGA120412WL			2.1	4	○	○						●	●														
2QP-CNMA120412W			2.4	2	○	○																●					
4QP-CNMA120412W	2.4		4	○	○											●											
2QP-CNGA120416-E	1.6		3.3	2																						●	
2QP-CNGA120416-LT		3.3	2																						●		
2QP-CNGA120420-E	2	3.2	2																						●		
2QP-CNGA120420-LT		3.2	2																						●		
Finishing	2QP-CNGA120402	0.2	2.3	2		○				●	●																
	2QP-CNGA120402-LC		2.3	2					○		●	●															
	2QP-CNGA120404	0.4	2.3	2		○				●	●		●	●					●	●	●	●	●	●	●	●	
	T2QP-CNGA120404		2.3	2	○	○					●	●		●	●					●	●	●	●	●	●	●	
	2QP-CNGA120404SR		2.3	2	○	○								●													
	4QS-CNGA120404		1.6	4	○	○					●	●															
	4QS-CNGA120404SR		1.6	4	○	○								●													
	4QP-CNGA120404		2.3	4	○	○										●	●	●									
	2QP-CNGA120404-LC		2.3	2						○		●	●														
	4QS-CNGA120404-LC		1.6	4						○		●	●														

T at the beginning of the designation means 10 pieces per package.

● : Line up

Reference pages: External toolholder → **C015** - Internal toolholder → **D025** -
 J-Series toolholder → **G050** TungCap → **K008** -
 PINZBOHR® → **K178** - Cartridge → **K181** -

CN



80° Rhombic with hole

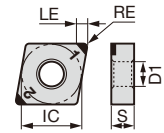

IC : 12.7 mm
 D1 : 5.16 mm
 S : 4.76 mm

K Cast iron																						●●	●
S Superalloy																						●●	●
H Hard material	●	●●	*	●	●●	*	●	●●	●	●●	●	●●	●	●●	●	●●	*					●●	●*
Sintered metal																						●●	●*

Application	Designation	Dimension (mm)				Standard	Problem				Material																		
		RE	LE	No. of corners	Wiper		Burr	Flank wear	Crater wear	Chipping	BXA10	BXA20	BR35F	BXM10	BXM20	BXC50	BXA30	BXA40	BX310	BX330	BX360	BX380	BX470	BX480	BX930				
																										K	S	H	Sintered metal
Finishing	2QP-CNGA120408	0.8	2.2	2	○					●	●		●	●						●	●	●	●	●	●	●	●	●	
	T2QP-CNGA120408		2.2	2	○																								
	2QP-CNGA120408SR		2.2	2	○																								
	4QS-CNGA120408		1.5	4	○						●	●																	
	4QS-CNGA120408SR		1.5	4	○																								
	4QP-CNGA120408	2.2	4	○											●	●	●												
	2QP-CNGA120408-LC	0.8	2.2	2				○		●	●																		
	4QS-CNGA120408-LC		1.5	4				○		●	●																		
	2QP-CNGA120412	1.2	2.4	2	○					●	●		●	●							●	●	●	●	●	●	●	●	
	2QP-CNGA120412SR		2.4	2	○																								
	4QS-CNGA120412		1.7	4	○						●	●																	
	4QS-CNGA120412SR		1.7	4	○																								
	4QP-CNGA120412		2.4	4	○											●	●	●											
	2QP-CNGA120412-LC	2.4	2					○		●	●																		
	4QS-CNGA120412-LC	1.7	4					○		●	●																		
	2QP-CNGA120416	1.6	3.3	2	○					●	●																		
	2QP-CNGA120416SR		3.3	2	○																								
	2QP-CNGA120420	2	3.2	2	○					●	●																		
	2QP-CNGA120420SR		3.2	2	○																								
	2QP-CNGA120424	2.4	3.1	2	○					●	●																		
	2QP-CNGA120424SR		3.1	2	○																								
Medium cutting	2QP-CNGA120404-H	0.4	2.3	2				○	●	●			●								●	●							
	2QP-CNGA120404HC		2.3	2				○					●																
	4QS-CNGA120404-H		1.6	4				○		●	●																		
	4QS-CNGA120404HC		1.6	4				○					●																
	4QP-CNGA120404-H	2.3	4				○												●										
	2QP-CNGA120408-H	0.8	2.2	2				○	●	●			●									●	●						
	2QP-CNGA120408HC		2.2	2				○					●																
	4QS-CNGA120408-H		1.5	4				○		●	●																		
	4QS-CNGA120408HC		1.5	4				○					●																
	4QP-CNGA120408-H	2.2	4				○													●									
	2QP-CNGA120412-H	1.2	2.4	2				○	●	●			●										●	●					
	2QP-CNGA120412HC		2.4	2				○					●																
	4QS-CNGA120412-H		1.7	4				○		●	●																		
	4QS-CNGA120412HC		1.7	4				○					●																
	4QP-CNGA120412-H	2.4	4				○													●									
	2QP-CNGA120416HC	1.6	3.3	2				○						●															
	2QP-CNGA120420HC	2	3.2	2				○						●															
	2QP-CNGA120424HC	2.4	3.1	2				○						●															

● : Line up

Reference pages: External toolholder → C015 - Internal toolholder → D025 -
 J-Series toolholder → G050 TungCap → K008 -
 PINZBOHR® → K178 - Cartridge → K181 -

Grade
 Insert
 Ext. Toolholder
 Int. Toolholder
 Threading
 Grooving
 Miniature tool
 Milling cutter
 Endmill
 Drilling tool
 Tooling System
 User's Guide
 Index



CBN Insert NEGATIVE TYPE

- : Continuous cutting
- : Light interrupted cutting
- ※ : Heavy interrupted cutting

CN with chipbreaker

 **80° Rhombic with hole**

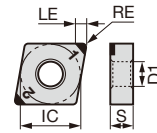

IC : 12.7 mm
D1 : 5.16 mm
S : 4.76 mm

Application	Designation	Dimension (mm)				Standard	Problem				BXA10	BXA20	BR35F	BXM10	BXM20	BXA40	
		RE	LE	No. of corners	Wiper		Burr	Finak wear	Crater wear	Chipping							
																	K
Precision finishing	2QP-CNGM120404-HP	0.4	2.3	2	○					●	●	●	●				
	4QS-CNGG120404-HP		1.6	4	○					●	●	●	●				
	2QP-CNGM120404-HS		2.3	2	○					●	●	●	●				
	4QS-CNGG120404-HS		1.6	4	○					●	●	●	●				
	2QP-CNGM120408-HP	0.8	2.2	2	○					●	●	●	●				
	4QS-CNGG120408-HP		1.5	4	○					●	●	●	●				
	2QP-CNGM120408WL-HP		2.2	2	○	○					●	●	●	●			
	4QS-CNGG120408WL-HP		1.8	4	○	○					●	●	●	●			
	2QP-CNGM120408-HS	1.2	2.2	2	○					●	●	●	●				
	4QS-CNGG120408-HS		1.8	4	○					●	●	●	●				
	2QP-CNGM120408WL-HS		2.2	2	○	○					●	●	●	●			
	4QS-CNGG120412-HS		2.2	4	○						●	●	●	●			
2QP-CNGM120412WL-HS	2.4	2	○	○					●	●	●	●					
Medium cutting	2QP-CNGM120408-HF	0.8	2.2	2	○						●			●			
	4QS-CNGG120408-HF		1.8	4	○						●			●			
	4QP-CNGG120408-HF		2.2	4	○						●			●			
	2QP-CNGM120408-HM		2.2	2	○						●			●			
	4QS-CNGG120408-HM	1.5	4	○						●			●				
	4QP-CNGG120408-HM	2.2	4	○						●			●				
	2QP-CNGM120412-HF	1.2	2.4	2	○						●			●			
	4QS-CNGG120412-HF		2.2	4	○						●			●			
	4QP-CNGG120412-HF		2.4	4	○						●			●			
	2QP-CNGM120412-HM		2.4	2	○						●			●			
	4QS-CNGG120412-HM	1.7	4	○						●			●				
	4QP-CNGG120412-HM	2.4	4	○						●			●				

● : Line up

CN Solid insert

 **80° Rhombic without hole**

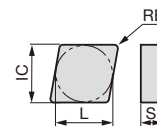

IC : 9.525 mm
S : 3.18 mm

Application	Designation	Dimension (mm)				Standard	Problem				BXC90				
		RE	LE	No. of corners	Wiper		Burr	Finak wear	Crater wear	Chipping					
												K	S	H	Material
Medium cutting	S-CNGN090308	0.8		4	○					●					
	S-CNGN090312	1.2		4	○					●					

● : Line up

CN Solid insert

 **80° Rhombic without hole**

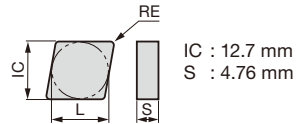

	K	S	H																	
Cast iron	*																			
Superalloy																				
Hard material																				
Sintered metal																				

Application	Designation	Dimension (mm)		No. of corners	Wiper	Standard	Problem				Problem										
		RE	LE				Burr	Flank wear	Crater wear	Chipping											
Medium cutting	S-CNGN120408	0.8		4		○						●									
	S-CNGN120412	1.2		4		○						●									

● : Line up

CN

 **80° Rhombic with hole**

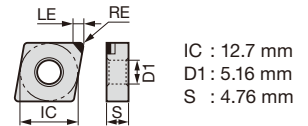

	K	S	H																	
Cast iron																				
Superalloy																				
Hard material			●	●																
Sintered metal																				

Application	Designation	Dimension (mm)		No. of corners	Wiper	Standard	Problem				Problem										
		RE	LE				Burr	Flank wear	Crater wear	Chipping											
Medium cutting	CNGA120402-QBN	0.2	4.1	1		○						●									
	CNGA120404-QBN	0.4	4	1		○						●									
	CNGA120408-QBN	0.8	3.9	1		○						●									
	CNGA120412-QBN	1.2	3.9	1		○						●									

● : Line up

Reference pages: External toolholder → C015 - Internal toolholder → D025 -
 J-Series toolholder → G050 TungCap → K008 -
 PINZBOHR® → K178 - Cartridge → K181 -



CBN Insert NEGATIVE TYPE

- : Continuous cutting
- ◐ : Light interrupted cutting
- ✱ : Heavy interrupted cutting

DN

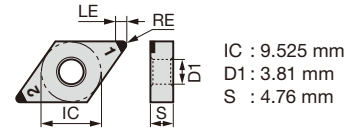

IC : 9.525 mm
D1 : 3.81 mm
S : 4.76 mm

55° Rhombic with hole

K	Cast iron																
S	Superalloy																
H	Hard material	●	●														
	Sintered metal																

Application	Designation	Dimension (mm)			Wiper	Standard	Problem																						
		RE	LE	No. of corners			Burr	Flak wear	Crater wear	Chipping	BXA10	BXA20																	
Finishing	2QP-DNGA110404	0.4	2.5	2		○					●	●																	
	2QP-DNGA110408	0.8	2.1	2		○					●	●																	
	2QP-DNGA110412	1.2	2	2		○					●	●																	

● : Line up

DN

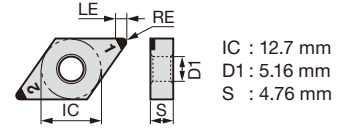

IC : 12.7 mm
D1 : 5.16 mm
S : 4.76 mm

55° Rhombic with hole

K	Cast iron																●	●
S	Superalloy																●	●
H	Hard material	●	●	*	●	●	*	●	●	●	●	●	●	●	●	●	●	●
	Sintered metal															●	●	

Application	Designation	Dimension (mm)			Wiper	Standard	Problem																						
		RE	LE	No. of corners			Burr	Flak wear	Crater wear	Chipping	BXA10	BXA20	BR35F	BXM10	BXM20	BXC50	BXA30	BXA40	BX310	BX330	BX360	BX380	BX470	BX480	BX815	BX930			
Precision finishing	2QP-DNGA150402-LF	0.2	2.7	2		○					●	●																	
	4QS-DNGA150402-LF		2.2	4		○					●	●																	
	2QP-DNGA150402-L	0.4	2.7	2		○			○		●	●															●		
	2QP-DNGA150404-E		2.5	2		○				○		●	●														●		
	2QP-DNGA150404-LT	0.8	2.5	2		○				○																	●		
	2QP-DNGA150404-LF		2.5	2		○				○		●	●														●		
	4QS-DNGA150404-LF	1.2	2	4		○			○		●	●															●		
	2QP-DNGA150404-L		2.5	2					○		●	●			●	●						●							
	2QP-DNGA150404WJ	0.2	2.5	2	○	○						●	●			●	●												
	2QP-DNGA150408-E		2.1	2								●	●															●	
	2QP-DNGA150408-LT	0.4	2.1	2																								●	
	2QP-DNGA150408-LF		2.1	2		○				○		●	●															●	
	4QS-DNGA150408-LF	0.8	1.6	4		○						●	●															●	
	2QP-DNGA150408-L		2.1	2			○			○		●	●			●	●						●					●	
2QP-DNGA150408WJ	1.2	2.1	2	○	○						●	●			●	●											●		
2QP-DNGA150412-E		2	2																									●	
2QP-DNGA150412-LT	0.2	2	2																								●		
2QP-DNGA150412-LF		2	2				○				●	●															●		
4QS-DNGA150412-LF	0.4	1.6	4		○				○		●	●															●		
2QP-DNGA150412-L		2	2						○		●	●			●												●		
Finishing	2QP-DNGA150402	0.2	2.7	2		○					●	●																	
	4QS-DNGA150402		2.2	4		○					●	●																	
	2QP-DNGA150402-LC		2.7	2						○		●	●																
	4QS-DNGA150402-LC		2.2	4						○		●	●																
	2QP-DNGA150404	0.4	2.5	2		○					●	●			●	●						●	●	●	●	●	●	●	
	4QP-DNGA150404		2.5	4		○																	●	●	●	●	●	●	
	2QP-DNGA150404SR		2.5	2		○						●	●																
	4QS-DNGA150404		2	4		○						●	●			●													
	4QS-DNGA150404SR		2	4		○																							
	2QP-DNGA150404-LC		2.5	2						○		●	●																
4QS-DNGA150404-LC	2	4						○		●	●																		

Please see page L025 about the toolholders recommended for wiper inserts of the designation with WJ at the end.

● : Line up

DN



55° Rhombic with hole

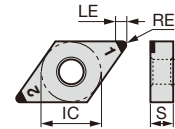

IC : 12.7 mm
D1 : 5.16 mm
S : 4.76 mm

K	Cast iron																					●	◐	✱	
S	Superalloy																						●	◐	✱
H	Hard material	●	◐	✱	●	◐	✱	●	◐	✱	●	◐	✱	●	◐	✱	●	◐	✱	●	◐	✱	●	◐	✱
	Sintered metal																						●	◐	✱

Application	Designation	Dimension (mm)				Standard	Problem				Material																
		RE	LE	No. of corners	Wiper		Burr	Finak wear	Crater wear	Chipping	BXA10	BXA20	BR35F	BXM10	BXM20	BXC50	BXA30	BXA40	BX310	BX330	BX360	BX380	BX470	BX480	BX930		
																										K	S
Finishing	2QP-DNGA150408	0.8	2.1	2	○					●	●	●	●														
	2QP-DNGA150408SR		2.1	2	○																						
	4QS-DNGA150408		1.6	4	○					●	●																
	4QS-DNGA150408SR		1.6	4	○																						
	4QP-DNGA150408		2.1	4	○										●	●	●										
	2QP-DNGA150408-LC		2.1	2					○		●	●															
	4QS-DNGA150408-LC	1.6	4					○		●	●																
	2QP-DNGA150412	1.2	2	2	○					●	●	●	●					●	●	●	●		●	●			
	2QP-DNGA150412SR		2	2	○																						
	4QS-DNGA150412		1.6	4	○					●	●																
	4QS-DNGA150412SR		1.6	4	○																						
	4QP-DNGA150412		2	4	○										●	●	●										
	2QP-DNGA150412-LC		2	2					○		●	●															
	4QS-DNGA150412-LC	1.6	4					○		●	●																
	2QP-DNGA150416	1.6	3.4	2	○					●	●																
	2QP-DNGA150416SR		3.4	2	○																						
	2QP-DNGA150420	2	3	2	○					●	●																
	2QP-DNGA150420SR		3	2	○																						
	2QP-DNGA150424	2.4	2.6	2	○					●	●																
	2QP-DNGA150424SR		2.6	2	○																						
Medium cutting	2QP-DNGA150404-H	0.4	2.5	2				○	●	●			●							●	●						
	2QP-DNGA150404HC		2.5	2	○																						
	4QS-DNGA150404-H		2	4					○	●	●																
	4QS-DNGA150404HC		2	4					○																		
	4QP-DNGA150404-H	2.5	4					○										●									
	2QP-DNGA150408-H	0.8	2.1	2	○				●	●			●							●	●						
	2QP-DNGA150408HC		2.1	2	○																						
	4QS-DNGA150408-H		1.6	4					○	●	●																
	4QS-DNGA150408HC		1.6	4					○																		
	4QP-DNGA150408-H	2.1	4					○										●									
	2QP-DNGA150412-H	1.2	2	2	○				○	●	●			●						●	●						
	2QP-DNGA150412HC		2	2	○																						
	4QS-DNGA150412-H		1.6	4					○	●	●																
	4QS-DNGA150412HC		1.6	4					○																		
	4QP-DNGA150412-H	2	4					○										●									
	2QP-DNGA150416HC	1.6	3.4	2					○																		
	2QP-DNGA150420HC	2	3	2					○																		
	2QP-DNGA150424HC	2.4	2.6	2					○																		

● : Line up



CBN Insert NEGATIVE TYPE

● : Continuous cutting
●○ : Light interrupted cutting
* : Heavy interrupted cutting

DN with chipbreaker

55° Rhombic with hole

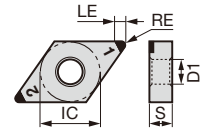

IC : 12.7 mm
D1 : 5.16 mm
S : 4.76 mm

K	Cast iron																											
S	Superalloy																											
H	Hard material	●	●○	*		●	●○	●○																				
	Sintered metal																											

Application	Designation	Dimension (mm)		No. of corners	Wiper	Standard	Problem				BXA10	BXA20	BR35F	BXM10	BXM20	BXA40												
		RE	LE				Burr	Flank wear	Crater wear	Chipping																		
Precision finishing	2QP-DNGM150404-HP	0.4	2.5	2		○					●	●	●	●														
	4QS-DNGG150404-HP		2	4		○					●	●	●															
	2QP-DNGM150404-HS		2.5	2		○					●	●	●															
	4QS-DNGG150404-HS		2	4		○					●	●	●															
	2QP-DNGM150408-HP	0.8	2.1	2		○					●	●	●	●														
	4QS-DNGG150408-HP		1.6	4		○					●	●	●															
	2QP-DNGM150408-HS		2.1	2		○					●	●	●															
	4QS-DNGG150408-HS		1.6	4		○					●	●	●															
	2QP-DNGM150412-HP	1.2	2	2		○					●	●	●															
	2QP-DNGM150412-HS		2	2		○					●	●	●															
	4QS-DNGG150412-HS		1.6	4		○					●	●	●															
	2QP-DNGM150408-HF		0.8	2.1	2		○						●				●											
4QS-DNGG150408-HF	2	4			○						●																	
4QP-DNGG150408-HF	2.1	4			○											●												
2QP-DNGM150408-HM	2.1	2			○											●												
4QS-DNGG150408-HM	1.6	4			○							●																
4QP-DNGG150408-HM	2.1	4			○											●												
2QP-DNGM150412-HF	1.2	2		2		○						●				●												
4QS-DNGG150412-HF		2.6		4		○						●																
4QP-DNGG150412-HF		2	4		○											●												
2QP-DNGM150412-HM		2	2		○											●												
4QP-DNGG150412-HM	2	4		○											●													

● : Line up

DN

55° Rhombic with hole

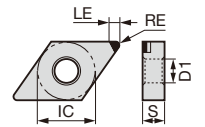

IC : 12.7 mm
D1 : 5.16 mm
S : 4.76 mm

K	Cast iron																										
S	Superalloy																										
H	Hard material	●○																									
	Sintered metal																										

Application	Designation	Dimension (mm)		No. of corners	Wiper	Standard	Problem				BX360															
		RE	LE				Burr	Flank wear	Crater wear	Chipping																
Finishing	DNGA150402-QBN	0.2	4.3	1		○					●															
	DNGA150404-QBN	0.4	4.4	1		○					●															
	DNGA150408-QBN	0.8	3.8	1		○					●															
	DNGA150412-QBN	1.2	3.4	1		○					●															

● : Line up

Reference pages: External toolholder → **C034** - Internal toolholder → **D069** -
J-Series toolholder → **G068** TungCap → **C034** -, **K012** -

CBN Insert NEGATIVE TYPE

● : Continuous cutting
 ●● : Light interrupted cutting
 ●●● : Heavy interrupted cutting

FN

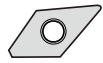

45° Rhombic with hole

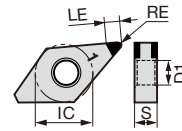

IC : 12.7 mm
 D1 : 5.16 mm
 S : 4.76 mm

Application	Designation	Dimension (mm)		No. of corners	Wiper	Standard	Problem				BXA20		
		RE	LE				Burr	Finak wear	Crater wear	Chipping			
												Standard	Burr
Precision finishing	2QP-FNGA150404-LF	0.4	2.6	2								●●	
	2QP-FNGA150404-L		2.6	2									●●
	2QP-FNGA150408-LF	0.8	3	2								●●	
	2QP-FNGA150408-L		3	2									●●
	2QP-FNGA150412-LF	1.2	3.3	2									●●
	2QP-FNGA150412-L		3.3	2									●●
Finishing	2QP-FNGA150402	0.2	2.8	2								●●	
	2QP-FNGA150404	0.4	2.6	2								●●	
	2QP-FNGA150404-LC		2.6	2									●●
	2QP-FNGA150408	0.8	3	2								●●	
	2QP-FNGA150408-LC		3	2									●●
	2QP-FNGA150412	1.2	3.3	2								●●	
	2QP-FNGA150412-LC		3.3	2									●●
	Medium cutting	2QP-FNGA150404-H	0.4	2.6	2								●●
2QP-FNGA150408-H		0.8	3	2								●●	
2QP-FNGA150412-H		1.2	3.3	2								●●	

● : Line up

FN with chipbreaker

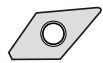

45° Rhombic with hole

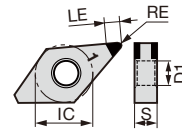

IC : 12.7 mm
 D1 : 5.16 mm
 S : 4.76 mm

Application	Designation	Dimension (mm)		No. of corners	Wiper	Standard	Problem				BXA20	
		RE	LE				Burr	Finak wear	Crater wear	Chipping		
												Standard
Precision finishing	2QP-FNGG150404-HP	0.4	2.6	2								●●
	2QP-FNGG150408-HP	0.8	3	2								●●
	2QP-FNGG150412-HP	1.2	3.3	2								●●

● : Line up

Reference pages: External toolholder → C034 - Internal toolholder → D069 -
 J-Series toolholder → G068 TungCap → C034 -, K012 -

FN

45° Rhombic with hole

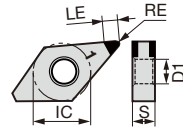

IC : 12.7 mm
 D1 : 5.16 mm
 S : 6.35 mm

K	Cast iron																					
S	Superalloy																					
H	Hard material	●●																				
	Sintered metal																					

Application	Designation	Dimension (mm)				Standard	Problem					BXA20											
		RE	LE	No. of corners	Wiper		Burr	Finak wear	Crater wear	Chipping													
Precision finishing	2QP-FNGA150604-LF	0.4	2.6	2		○					●●												
	2QP-FNGA150604-L		2.6	2			○					●●											
	2QP-FNGA150608-LF	0.8	3	2		○					●●												
	2QP-FNGA150608-L		3	2			○					●●											
	2QP-FNGA150612-LF	1.2	3.3	2		○						●●											
	2QP-FNGA150612-L		3.3	2			○					●●											
Finishing	2QP-FNGA150604	0.4	2.6	2		○						●●											
	2QP-FNGA150604-LC		2.6	2					○			●●											
	2QP-FNGA150608	0.8	3	2		○						●●											
	2QP-FNGA150608-LC		3	2					○			●●											
	2QP-FNGA150612	1.2	3.3	2		○						●●											
	2QP-FNGA150612-LC		3.3	2					○			●●											
Medium cutting	2QP-FNGA150604-H	0.4	2.6	2								○	●●										
	2QP-FNGA150608-H	0.8	3	2								○	●●										
	2QP-FNGA150612-H	1.2	3.3	2								○	●●										

● : Line up

FN with chipbreaker

45° Rhombic with hole

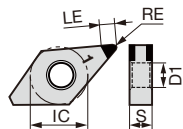

IC : 12.7 mm
 D1 : 5.16 mm
 S : 6.35 mm

K	Cast iron																					
S	Superalloy																					
H	Hard material	●●																				
	Sintered metal																					

Application	Designation	Dimension (mm)				Standard	Problem					BXA20										
		RE	LE	No. of corners	Wiper		Burr	Finak wear	Crater wear	Chipping												
Precision finishing	2QP-FNGG150604-HP	0.4	2.6	2		○						●										
	2QP-FNGG150608-HP	0.8	3	2		○						●										
	2QP-FNGG150612-HP	1.2	3.3	2		○						●										

● : Line up

Reference pages: External toolholder → C034 - Internal toolholder → D069 -
 J-Series toolholder → G068 TungCap → C034 -, K012 -

Grade
 Insert
 Ext. Toolholder
 Int. Toolholder
 Threading
 Grooving
 Miniature tool
 Milling cutter
 Endmill
 Drilling tool
 Tooling System
 User's Guide
 Index

CBN Insert NEGATIVE TYPE

- : Continuous cutting
- ◐ : Light interrupted cutting
- ◑ : Heavy interrupted cutting

GN

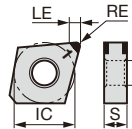

IC : 12.7 mm
D1 : 5.16 mm
S : 4.76 mm



70° Rhombic with hole

K	Cast iron																																
S	Superalloy																																
H	Hard material	●	●●	◑	●●	●●																											
	Sintered metal							●●																									

Application	Designation	Dimension (mm)			Standard	Problem					BXA10	BXA20	BR35F	BXM20	BX360	BX470	BX930
		RE	LE	No. of corners		Wiper	Burr	Flank wear	Crater wear	Chipping							
Precision finishing	2QP-GNGA120402-LF	0.2	2.2	2		○				●	●						
	2QP-GNGA120402-L		2.2	2			○			●	●						
	2QP-GNGA120404-LF	0.4	2.1	2		○				●	●						
	2QP-GNGA120404-L		2.1	2			○			●	●						
	2QP-GNGA120408-LF	0.8	2.1	2		○				●	●						
	2QP-GNGA120408-L		2.1	2			○			●	●						
	2QP-GNGA120412-LF	1.2	2.2	2		○				●	●						
	2QP-GNGA120412-L		2.2	2			○			●	●						
Finishing	2QP-GNGA120402	0.2	2.2	2		○				●	●						
	2QP-GNGA120402-LC		2.2	2				○		●	●						
	2QP-GNGA120404	0.4	2.1	2		○				●	●		●	●			
	2QP-GNGA120404SR		2.1	2		○					●	●	●				
	2QP-GNGA120404-LC	0.8	2.1	2		○				●	●						
	2QP-GNGA120408		2.1	2		○					●	●	●	●			
	2QP-GNGA120408SR	1.2	2.1	2		○				●	●						
	2QP-GNGA120408-LC		2.1	2			○				●	●	●	●			
	2QP-GNGA120412	1.2	2.2	2		○				●	●		●	●	●	●	
	2QP-GNGA120412SR		2.2	2		○					●	●	●	●			
	2QP-GNGA120412-LC		2.2	2			○				●	●					
Medium cutting	2QP-GNGA120404-H	0.4	2.1	2						○	●	●					
	2QP-GNGA120404HC		2.1	2						○		●					
	2QP-GNGA120408-H	0.8	2.1	2						○	●	●					
	2QP-GNGA120408HC		2.1	2						○		●					
	2QP-GNGA120412-H	1.2	2.2	2						○	●	●					
	2QP-GNGA120412HC		2.2	2						○		●					

● : Line up

GN with chipbreaker

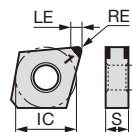

IC : 12.7 mm
D1 : 5.16 mm
S : 4.76 mm



70° Rhombic with hole

K	Cast iron																															
S	Superalloy																															
H	Hard material	●	●●	●																												
	Sintered metal																															

Application	Designation	Dimension (mm)			Standard	Problem					BXA10	BXA20	BXM10
		RE	LE	No. of corners		Wiper	Burr	Flank wear	Crater wear	Chipping			
Precision finishing	2QP-GNGG120404-HP	0.4	2.1	2		○					●	●	●
	2QP-GNGG120404-HS		2.1	2		○					●	●	●
	2QP-GNGG120408-HP	0.8	2.1	2		○					●	●	●
	2QP-GNGG120408-HS		2.1	2		○					●	●	●
	2QP-GNGG120412-HP	1.2	2.2	2		○						●	●
	2QP-GNGG120412-HS		2.2	2		○						●	●

● : Line up

Reference pages: External toolholder → C015 - Internal toolholder → D025 -
J-Series toolholder → G050 TungCap → K008 -

CBN Insert NEGATIVE TYPE

- : Continuous cutting
- ◐ : Light interrupted cutting
- ✱ : Heavy interrupted cutting

SN



Square with hole

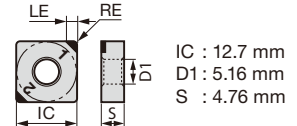

IC : 12.7 mm
D1 : 5.16 mm
S : 4.76 mm

K	Cast iron																			●	●							
S	Superalloy																				●	●						
H	Hard material	●	●	✱	●	✱	●	●	●	●	●	●	●	●	●	●	●	●	●	●	●	●	●	●	●	●	●	
	Sintered metal																				●	●						

Application	Designation	Dimension (mm)				Standard	Problem																				
		RE	LE	No. of corners	Wiper		Burr	Finak wear	Crater wear	Chipping	BXA10	BXA20	BR35F	BXM20	BXC50	BXA40	BX310	BX330	BX360	BX380	BX480	BX930					
Precision finishing	2QP-SNGA120404-L	0.4	2.4	2			○																				
	2QP-SNGA120408-LF	0.8	2.4	2		○				●	●																
	2QP-SNGA120408-L		2.4	2			○				●	●															
	2QP-SNGA120412-LF	1.2	2.4	2			○			●	●																
	2QP-SNGA120412-L		2.4	2			○				●	●															
Finishing	2QP-SNGA120404	0.4	2.4	2		○				●	●						●	●	●	●	●	●	●	●	●	●	
	4QS-SNGA120404		1.8	4		○					●	●															
	4QP-SNGA120404		2.4	4		○								●	●												
	2QP-SNGA120408	0.8	2.4	2		○				●	●		●				●	●	●	●	●	●	●	●	●	●	
	2QP-SNGA120408SR		2.4	2		○						●															
	4QS-SNGA120408		1.8	4		○					●	●															
	4QS-SNGA120408SR	1.8	4		○						●																
	4QP-SNGA120408	2.4	4		○								●	●													
	2QP-SNGA120412	1.2	2.4	2		○				●	●		●				●	●	●	●	●	●	●	●	●	●	
	2QP-SNGA120412SR		2.4	2		○						●															
	4QS-SNGA120412		1.8	4		○					●	●															
	4QS-SNGA120412SR		1.8	4		○						●															
	4QP-SNGA120412		2.4	4		○								●	●												
	Medium cutting	2QP-SNGA120404-H	0.4	2.4	2					○												●	●				
		2QP-SNGA120408-H		2.4	2					○		●		●									●	●			
4QP-SNGA120408-H		0.8	2.4	4					○					●													
2QP-SNGA120412-H			2.4	2					○		●		●									●	●				
4QP-SNGA120412-H		1.2	2.4	4					○					●													
			2.4	4						○																	
			2.4	4						○																	

● : Line up

SN



Square without hole

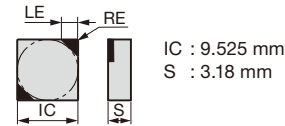

IC : 9.525 mm
S : 3.18 mm

K	Cast iron	●																									
S	Superalloy																										
H	Hard material																										
	Sintered metal																										

Application	Designation	Dimension (mm)				Standard	Problem																			
		RE	LE	No. of corners	Wiper		Burr	Finak wear	Crater wear	Chipping	BX910															
Finishing	2QP-SNGN090308	0.8	2.4	2		○																				
	2QP-SNGN090312	1.2	2.4	2		○																				

● : Line up

Reference pages: External toolholder → **C101 -** Internal toolholder → **D043 -**
 Cartridge → **K181 -**

SN Solid insert

Square without hole

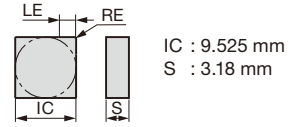

Material	Cutting Condition	Application	Problem
K Cast iron	✱		
S Superalloy			
H Hard material			
Sintered metal			

Application	Designation	Dimension (mm)		No. of corners	Wiper	Standard	Problem				BXC90
		RE	LE				Burr	Flank wear	Crater wear	Chipping	
Medium cutting	S-SNGN090308	0.8		8		○					●●
	S-SNGN090312	1.2		8		○					●●

● : Line up

SN Solid insert

Square without hole

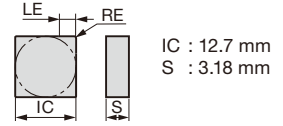

Material	Cutting Condition	Application	Problem
K Cast iron	✱		
S Superalloy			
H Hard material			
Sintered metal			

Application	Designation	Dimension (mm)		No. of corners	Wiper	Standard	Problem				BXC90
		RE	LE				Burr	Flank wear	Crater wear	Chipping	
Medium cutting	S-SNGN120308	0.8		8		○					●●
	S-SNGN120312	1.2		8		○					●●

● : Line up

SN Solid insert

Square without hole

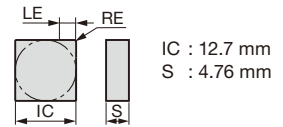

Material	Cutting Condition	Application	Problem
K Cast iron	✱		
S Superalloy			
H Hard material			
Sintered metal			

Application	Designation	Dimension (mm)		No. of corners	Wiper	Standard	Problem				BXC90
		RE	LE				Burr	Flank wear	Crater wear	Chipping	
Medium cutting	S-SNGN120408	0.8		8		○					●●
	S-SNGN120412	1.2		8		○					●●

● : Line up

Reference pages: External toolholder → **C101** - Internal toolholder → **D043** -
 Cartridge → **K181** -

CBN Insert NEGATIVE TYPE

- : Continuous cutting
- ◐ : Light interrupted cutting
- ✱ : Heavy interrupted cutting

SN



Square with hole

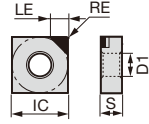

IC : 12.7 mm
D1 : 5.16 mm
S : 4.76 mm

K	Cast iron																		
S	Superalloy																		
H	Hard material				●●														
	Sintered metal																		

Application	Designation	Dimension (mm)		No. of corners	Wiper	Standard	Problem				BX360
		RE	LE				Burr	Finak wear	Crater wear	Chipping	
Finishing	SNGA120402-QBN	0.2	4.1	1		○					●
	SNGA120404-QBN	0.4	4.1	1		○					●
	SNGA120408-QBN	0.8	4.1	1		○					●
	SNGA120412-QBN	1.2	4.1	1		○					●

● : Line up

TN



Triangular with hole

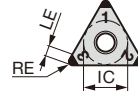

IC : 9.525 mm
D1 : 3.81 mm
S : 4.76 mm

K	Cast iron																	●●	●●
S	Superalloy																	●●	●●
H	Hard material						●●	●●	✱	●●	●●	●●	●●	●●	●●	●●	●●	●●	●●
	Sintered metal																	●●	✱

Application	Designation	Dimension (mm)		No. of corners	Wiper	Standard	Problem																			
		RE	LE				Burr	Finak wear	Crater wear	Chipping	BXA10	BXA20	BR35F	BXM10	BXM20	BXC50	BXA30	BXA40	BX310	BX330	BX360	BX380	BX470	BX480	BX815	BX930
Precision finishing	3QP-TNGA160402-LF	0.2	2.3	3		○					●	●														
	3QP-TNGA160402-L		2.3	3		○					●	●														
	3QP-TNGA160404F	0.4	2.2	3		○					●	●									●					
	3QP-TNGA160404-LF		2.2	3		○					●	●														
	3QP-TNGA160404-L		2.2	3		○			○		●	●	●	●					●							
	3QP-TNGA160404WG		2.4	3	○	○					●	●		●												
	3QP-TNGA160408F	0.8	1.9	3		○					●	●										●				
	3QP-TNGA160408-E		1.9	3		○					●	●														
	3QP-TNGA160408-LT		1.9	3						○	●	●												●		
	3QP-TNGA160408-LF		1.9	3			○				●	●														
	6QS-TNGA160408-LF		1.6	6			○				●	●														
	3QP-TNGA160408-L		1.9	3					○		●	●	●	●												
	3QP-TNGA160408WG		2.2	3	○	○					●	●		●	●											
	3QP-TNGA160412-LF		1.2	2.4	3		○				●	●														
	6QS-TNGA160412-LF	1.8		6		○				●	●															
	3QP-TNGA160412-L	2.4	3					○		●	●	●	●								●					
Finishing	3QP-TNGA160402	0.2	2.3	3		○				●	●															
	3QP-TNGA160402-LC		2.3	3					○	●	●															
	3QP-TNGA160404	0.4	2.2	3		○				●	●		●	●				●	●	●	●	●	●	●		
	T3QP-TNGA160404		2.2	3		○				●	●								●							
	3QP-TNGA160404SR		2.2	3		○				●	●	●														
	6QS-TNGA160404		1.9	6		○				●	●			●												
	6QS-TNGA160404SR		1.9	6		○				●	●															
	6QP-TNGA160404		2.2	6		○				●	●				●	●	●									
	3QP-TNGA160404-LC		2.2	3					○	●	●															
	6QS-TNGA160404-LC		1.9	6					○	●	●															

T at the beginning of the designation means 10 pieces per package.
Please see page L025 about the toolholders recommended for wiper inserts of the designation with WG at the end.

● : Line up

CBN Insert NEGATIVE TYPE

- : Continuous cutting
- ◐ : Light interrupted cutting
- ✳ : Heavy interrupted cutting

TN



Triangular with hole

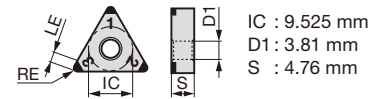

Application	Designation	Dimension (mm)			Wiper	Standard	Problem																		
		RE	LE	No. of corners			Burr	Finak wear	Crater wear	Chipping	BXA10	BXA20	BR35F	BXM10	BXM20	BXC50	BXA30	BXA40	BX310	BX330	BX360	BX380	BX470	BX480	BX930
Finishing	3QP-TNGA160408	0.8	1.9	3	○					●	●		●	●				●	●	●	●	●	●	●	
	T3QP-TNGA160408		1.9	3	○																				
	3QP-TNGA160408SR		1.9	3	○									●											
	6QS-TNGA160408SR		1.6	6	○									●											
	6QP-TNGA160408		1.9	6	○											●	●	●							
	3QP-TNGA160408-LC		1.9	3					○			●	●												
	6QS-TNGA160408-LC		1.9	6					○			●	●												
	3QP-TNGA160412		2.4	3	○							●	●		●	●				●	●	●	●	●	●
	3QP-TNGA160412SR		2.4	3	○									●											
	6QS-TNGA160412		1.8	6	○							●	●												
	6QS-TNGA160412SR		1.8	6	○									●											
	6QP-TNGA160412		2.4	6	○											●	●	●							
	3QP-TNGA160412-LC		2.4	3						○		●	●												
	6QS-TNGA160412-LC		1.8	6						○		●	●												
	3QP-TNGA160416		1.6	3.3	3	○						●	●												
	3QP-TNGA160416SR		3.3	3	○									●											
	3QP-TNGA160420		3	3	○							●	●												
	3QP-TNGA160420SR		3	3	○									●											
	3QP-TNGA160424		2.4	2.7	3	○						●	●												
	3QP-TNGA160424SR		2.7	3	○									●											
	Medium cutting		3QP-TNGA160404-H	0.4	2.2	3					○	●	●			●					●	●			
3QP-TNGA160404HC		2.2	3						○				●												
6QS-TNGA160404-H		1.9	6						○		●	●													
6QS-TNGA160404HC		1.9	6						○				●												
6QP-TNGA160404-H		2.2	6						○						●										
3QP-TNGA160408-H		1.9	3							○	●	●			●					●	●				
3QP-TNGA160408HC		1.9	3							○				●											
6QS-TNGA160408-H		1.6	6							○	●	●													
6QS-TNGA160408HC		1.6	6							○				●											
6QP-TNGA160408-H		1.9	6						○						●										
3QP-TNGA160412-H		2.4	3						○	●	●			●					●	●					
3QP-TNGA160412HC		2.4	3						○				●												
6QS-TNGA160412-H		1.2	1.8	6					○	●	●														
6QS-TNGA160412HC		1.8	6						○				●												
6QP-TNGA160412-H		2.4	6						○						●										
3QP-TNGA160416HC		1.6	3.3	3					○					●											
3QP-TNGA160420HC		2	3	3					○					●											
3QP-TNGA160424HC		2.4	2.7	3					○					●											

● : Line up

Reference pages: SN: External toolholder → C101 -, Internal toolholder → D043 -, Cartridge → K181 -
TN: External toolholder → C032 -, Internal toolholder → D049 -, Cartridge → K181 -

CBN Insert NEGATIVE TYPE

- : Continuous cutting
- : Light interrupted cutting
- ★ : Heavy interrupted cutting

TN Solid insert

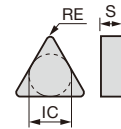

IC : 9.525 mm
S : 4.76 mm

Triangular without hole

K	Cast iron	*																			
S	Superalloy																				
H	Hard material																				
	Sintered metal																				

Application	Designation	Dimension (mm)		No. of corners	Wiper	Standard	Problem				BX360	BX360	BX360	BX360	BX360	BX360	BX360	BX360	BX360	BX360	BX360	BX360	
		RE	LE				Burr	Finak wear	Crater wear	Chipping													
Medium cutting	S-TNGN160408	0.8		6		O					●●												
	S-TNGN160412	1.2		6		O					●●												

● : Line up

TN

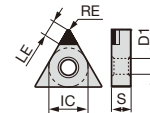

IC : 9.525 mm
D1 : 3.81 mm
S : 4.76 mm

Triangular with hole

K	Cast iron																					
S	Superalloy																					
H	Hard material										●●											
	Sintered metal																					

Application	Designation	Dimension (mm)		No. of corners	Wiper	Standard	Problem				BX360	BX360	BX360	BX360	BX360	BX360	BX360	BX360	BX360	BX360	BX360		
		RE	LE				Burr	Finak wear	Crater wear	Chipping													
Finishing	TNGA160402-QBN	0.2	4.4	1		O					●●												
	TNGA160404-QBN	0.4	4.2	1		O					●●												
	TNGA160408-QBN	0.8	4	1		O					●●												
	TNGA160412-QBN	1.2	3.7	1		O					●●												

● : Line up

Reference pages: External toolholder → C032 - Internal toolholder → D049 -
J-Series toolholder → G051 - Cartridge → K181 -

Grade A
Insert B
Toolholder C
Ext. Toolholder D
Int. Toolholder E
Threading F
Grooving G
Miniature tool H
Milling cutter I
Endmill J
Drilling tool K
Tooling System L
User's Guide M

VN with chipbreaker



35° Rhombic with hole

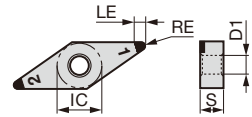

IC : 9.525 mm
 D1 : 3.81 mm
 S : 4.76 mm

Application	Designation	Dimension (mm)				Problem					Material								
		RE	LE	No. of corners	Wiper	Standard	Burr	Flank wear	Crater wear	Chipping	BXA10	BXA20	BXM10	BXM20	BXA40	K	S	H	Sintered metal
Precision finishing	2QP-VNGM160404-HP	0.4	3.1	2		○				●	●								
	4QS-VNGG160404-HP	0.4	2.6	4		○				●	●								
	2QP-VNGM160404-HS	0.4	3.1	2		○				●	●								
	4QS-VNGG160404-HS	0.4	2.6	4		○				●	●								
	2QP-VNGM160408-HP	0.8	2.2	2		○				●	●	●							
	4QS-VNGG160408-HP	0.8	1.7	4		○				●	●								
Medium cutting	2QP-VNGM160408-HS	0.8	2.2	2		○				●	●								
	4QS-VNGG160408-HS	0.8	1.7	4		○				●	●								
	2QP-VNGM160408-HF	0.8	2.2	2		○							●						
	4QP-VNGG160408-HF	0.8	2.2	4		○							●						
	2QP-VNGM160408-HM	0.8	2.2	2		○							●		●				
	4QS-VNGG160408-HM	0.8	1.7	4		○					●								
	4QP-VNGG160408-HM	0.8	2.2	4		○									●				
	4QP-VNGG160408-HM	0.8	2.2	4		○									●				

● : Line up

WN



80° Trigon with hole

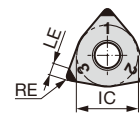

IC : 12.7 mm
 D1 : 5.16 mm
 S : 4.76 mm

Application	Designation	Dimension (mm)				Problem					Material																		
		RE	LE	No. of corners	Wiper	Standard	Burr	Flank wear	Crater wear	Chipping	BXA10	BXA20	BXM10	BXM20	BXC50	BXA30	BXA40	BX310	BX330	BX360	BX380	BX480	BX930	K	S	H	Sintered metal		
																												Cast iron	Superalloy
Precision finishing	3QP-WNGA080408-LF	0.8	2.2	3			○				●	●																	
	6QS-WNGA080408-LF	0.8	1.5	6			○				●	●																	
	3QP-WNGA080408-L	0.8	2.2	3				○			●	●																	
	3QP-WNGA080408WL	0.8	2.2	3	○	○					●	●	●	●															
	6QS-WNGA080408WL	0.8	1.8	6	○	○					●	●																	
Finishing	3QP-WNGA080404	0.4	2.3	3							●	●																	
	6QS-WNGA080404	0.4	1.6	6							●	●																	
	6QP-WNGA080404	0.4	2.3	6											●														
	3QP-WNGA080408	0.8	2.2	3							●	●	●	●					●	●	●	●	●	●	●	●	●	●	●
	6QS-WNGA080408	0.8	1.5	6							●	●																	
	6QP-WNGA080408	0.8	2.2	6											●	●	●												
	3QP-WNGA080412	1.2	2.4	3							●	●																	
6QS-WNGA080412	1.2	1.7	6							●	●																		
Medium cutting	3QP-WNGA080408-H	0.8	2.2	3						○	●	●																	
	6QS-WNGA080408-H	0.8	1.5	6						○	●	●																	

● : Line up

Reference pages: VN: External toolholder → C041 -, Internal toolholder → D074 -, TungCap → C042 -, K014 -
 WN: External toolholder → C024 -, Internal toolholder → D031 -, TungCap → C024 -, K010 -



CBN Insert NEGATIVE TYPE

- : Continuous cutting
- ◐ : Light interrupted cutting
- ◑ : Heavy interrupted cutting

YN

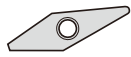

25° Rhombic with hole

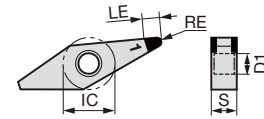

IC : 9.525 mm
D1 : 3.81 mm
S : 4.76 mm

Application	Designation	Dimension (mm)				Standard	Problem				BXA20													
		RE	LE	No. of corners	Wiper		Burr	Flank wear	Crater wear	Chipping														
Precision finishing	2QP-YNGA160404-LF	0.4	3.1	2		○					●													
	2QP-YNGA160404-L		3.1	2			○					●												
	2QP-YNGA160408-LF	0.8	3	2		○					●													
	2QP-YNGA160408-L		3	2			○					●												
Finishing	2QP-YNGA160402	0.2	3.5	2		○					●													
	2QP-YNGA160404	0.4	3.1	2		○					●													
	2QP-YNGA160404-LC		3.1	2					○			●												
	2QP-YNGA160408	0.8	3	2		○					●													
	2QP-YNGA160408-LC		3	2					○			●												

● : Line up

YN with chipbreaker

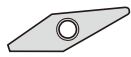

25° Rhombic with hole

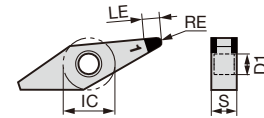

IC : 9.525 mm
D1 : 3.81 mm
S : 4.76 mm

Application	Designation	Dimension (mm)				Standard	Problem				BXA20												
		RE	LE	No. of corners	Wiper		Burr	Flank wear	Crater wear	Chipping													
Precision finishing	2QP-YNGG160404-HP	0.4	3.1	2		○					●												
	2QP-YNGG160408-HP	0.8	3	2		○					●												

● : Line up

Reference pages: External toolholder → C041 - Internal toolholder → D074 -
TungCap → C042 -, K014 -

CC

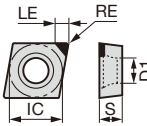

IC : 3.57 mm
D1 : 1.9 mm
S : 1.39 mm



80°Rhombic with hole, Positive 7°

Material	1	2	3	4	5	6	7	8	9	10	11	12	13	14	15	16	17	18	19	20
K Cast iron																				
S Superalloy																				
H Hard material	●																			
Sintered metal		◐◑																		

Application	Designation	Dimension (mm)			No. of corners	Wiper	Standard	Problem				BX310	BX470								
		RE	LE					Burr	Flak wear	Crater wear	Chipping										
Precision finishing	1QP-CCGW03X102	0.2	1.4	1		O					●	●									
	1QP-CCGW03X104	0.4	1.3	1		O					●	●									

● : Line up

CC

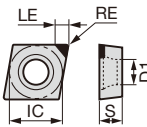

IC : 4.37 mm
D1 : 2.3 mm
S : 1.79 mm



80°Rhombic with hole, Positive 7°

Material	1	2	3	4	5	6	7	8	9	10	11	12	13	14	15	16	17	18	19	20
K Cast iron																				
S Superalloy																				
H Hard material	●																			
Sintered metal		◐◑																		

Application	Designation	Dimension (mm)			No. of corners	Wiper	Standard	Problem				BX310	BX470								
		RE	LE					Burr	Flak wear	Crater wear	Chipping										
Precision finishing	1QP-CCGW04T102	0.2	1.9	1		O					●	●									
	1QP-CCGW04T104	0.4	1.8	1		O					●	●									

● : Line up



CBN Insert POSITIVE TYPE

- : Continuous cutting
- ◐ : Light interrupted cutting
- ✱ : Heavy interrupted cutting

CC



80°Rhombic with hole, Positive 7°

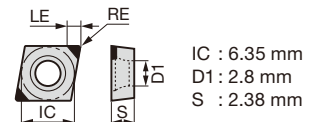

K Cast iron																	●	●						
S Superalloy																		●	●					
H Hard material	●	●	✱	●	●	●	●	●	●	●	●	●	●	●										
Sintered metal																	●	●	✱					

Application	Designation	Dimension (mm)		No. of corners	Wiper	Standard	Problem				BXA10	BXA20	BR35F	BXM10	BXM20	BXA30	BXA40	BX310	BX330	BX360	BX470	BX480	BX930	
		RE	LE				Burr	Finak wear	Crater wear	Chipping														
Precision finishing	2QP-CCGW060202-LF	0.2	2.3	2		○					●	●												
	2QP-CCGW060202-L		2.3	2			○					●	●											
	2QP-CCGW060204-LF	0.4	2.3	2		○					●	●												
	2QP-CCGW060204-L		2.3	2			○					●	●											
	2QP-CCGW060208-LF	0.8	2.2	2		○					●	●												
	2QP-CCGW060208-L		2.2	2			○					●	●											
Finishing	2QP-CCGW060202	0.2	2.3	2		○					●	●		●	●	●	●							
	2QP-CCMW060202		2.3	2			○											●	●	●				
	2QP-CCGW060202-LC		2.3	2			○					●	●											
	2QP-CCGW060204	0.4	2.3	2		○					●	●		●	●	●	●					●	●	
	2QP-CCGW060204SR		2.3	2			○							●										
	2QP-CCMW060204		2.3	2			○											●	●	●				●
	Q-CCMW060204		2.5	1			○													●				
	2QP-CCGW060204-LC	2.3	2			○					●	●												
	2QP-CCGW060208	0.8	2.2	2		○					●	●												
	2QP-CCGW060208SR		2.2	2			○						●											
	2QP-CCMW060208		2.2	2			○													●				
	2QP-CCGW060208-LC		2.2	2			○					●	●											

● : Line up

CC with chipbreaker



80°Rhombic with hole, Positive 7°

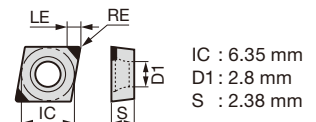

K Cast iron																							
S Superalloy																							
H Hard material	●	●	✱	●																			
Sintered metal																							

Application	Designation	Dimension (mm)		No. of corners	Wiper	Standard	Problem				BXA10	BXA20	BR35F	BXM10
		RE	LE				Burr	Finak wear	Crater wear	Chipping				
Precision finishing	2QP-CCGT060204-HP	0.4	2.3	2		○					●	●	●	●
	2QP-CCGT060204-HS		2.2	2			○				●	●	●	

● : Line up

Reference pages: External toolholder → **C030** - Internal toolholder → **D014** -
 J-Series toolholder → **G040** - PINZBOHR® → **K178** -

CBN Insert POSITIVE TYPE

- : Continuous cutting
- ◐ : Light interrupted cutting
- * : Heavy interrupted cutting

DC



55° Rhombic with hole, Positive 7°

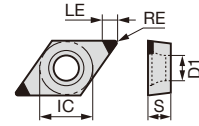

IC : 6.35 mm
D1 : 2.8 mm
S : 2.38 mm

Application	Designation	Dimension (mm)			Wiper	Standard	Problem				BXA10	BXA20	BR35F	BXM10	BXM20	BXA30	BXA40	BX310	BX330	BX360	BX470	BX480	BX930	
		RE	LE	No. of corners			Burr	Finak wear	Crater wear	Chipping														
							K	S	H	Material														
Finishing	2QP-DCGW070202-LF	0.2	2.7	2	O																			
	2QP-DCGW070202-L		2.7	2																				
	2QP-DCGW070204-LF	0.4	2.5	2	O																			
	2QP-DCGW070204-L		2.5	2	O																			
	2QP-DCGW070208-LF	0.8	2.1	2	O																			
	2QP-DCGW070208-L		2.1	2	O																			
Medium cutting	2QP-DCGW070202	0.2	2.7	2	O	●	●	●	●	●	●	●	●	●	●	●	●	●	●	●	●	●	●	●
	2QP-DCGW070202SR		2.7	2	O	●	●	●	●	●	●	●	●	●	●	●	●	●	●	●	●	●	●	●
	2QP-DCMW070202		2.7	2	O	●	●	●	●	●	●	●	●	●	●	●	●	●	●	●	●	●	●	●
	2QP-DCGW070202-LC		2.7	2	O	●	●	●	●	●	●	●	●	●	●	●	●	●	●	●	●	●	●	●
	2QP-DCGW070204	0.4	2.5	2	O	●	●	●	●	●	●	●	●	●	●	●	●	●	●	●	●	●	●	●
	2QP-DCGW070204SR		2.5	2	O	●	●	●	●	●	●	●	●	●	●	●	●	●	●	●	●	●	●	●
	2QP-DCMW070204		2.5	2	O	●	●	●	●	●	●	●	●	●	●	●	●	●	●	●	●	●	●	●
	Q-DCMW070204		2.1	1	O	●	●	●	●	●	●	●	●	●	●	●	●	●	●	●	●	●	●	●
	2QP-DCGW070204-LC	2.5	2	O	●	●	●	●	●	●	●	●	●	●	●	●	●	●	●	●	●	●	●	●
	2QP-DCGW070208	0.8	2.1	2	O	●	●	●	●	●	●	●	●	●	●	●	●	●	●	●	●	●	●	●
	2QP-DCGW070208SR		2.1	2	O	●	●	●	●	●	●	●	●	●	●	●	●	●	●	●	●	●	●	●
	2QP-DCGW070208-LC		2.1	2	O	●	●	●	●	●	●	●	●	●	●	●	●	●	●	●	●	●	●	●

● : Line up

DC

with chipbreaker

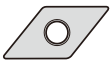

55° Rhombic with hole, Positive 7°

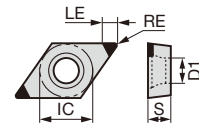

IC : 6.35 mm
D1 : 2.8 mm
S : 2.38 mm

Application	Designation	Dimension (mm)			Wiper	Standard	Problem				BXA10	BXA20	BR35F	BXM10
		RE	LE	No. of corners			Burr	Finak wear	Crater wear	Chipping				
							K	S	H	Material				
Precision finishing	2QP-DCGT070204-HP	0.4	2.5	2	O					●	●	●	●	
	2QP-DCGT070204-HS		2.5	2	O					●	●	●	●	

● : Line up

Reference pages: External toolholder → C046 - Internal toolholder → D056 -
J-Series toolholder → G052 -

Grade
Insert
Toolholder
Ext. Toolholder
Int. Toolholder
Threading
Grooving
Miniature tool
Milling cutter
Endmill
Drilling tool
Tooling System
User's Guide
Index



EP



**75° Rhombic,
Positive 11°
with hole**

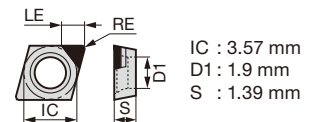

Application	Designation	Dimension (mm)		No. of corners	Wiper	Standard	Problem				BX310	BX470
		RE	LE				Burr	Finak wear	Crater wear	Chipping		
Finishing	1QP-EPGW03X102	0.2	1.4	1		○					●	●
	1QP-EPGW03X104	0.4	1.3	1		○					●	●

● : Line up

EP



**75° Rhombic,
Positive 11°
with hole**

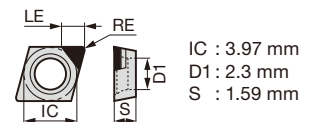

Application	Designation	Dimension (mm)		No. of corners	Wiper	Standard	Problem				BX310	BX470
		RE	LE				Burr	Finak wear	Crater wear	Chipping		
Finishing	1QP-EPGW040102	0.2	1.7	1		○					●	●
	1QP-EPGW040104	0.4	1.6	1		○					●	●

● : Line up

SP



**Square Positive 11°
with hole**

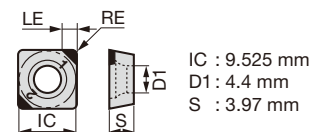

Application	Designation	Dimension (mm)		No. of corners	Wiper	Standard	Problem				BX910
		RE	LE				Burr	Finak wear	Crater wear	Chipping	
Finishing	2QP-SPGW09T308	0.8	2.4	2		○					●
	2QP-SPGW09T312	1.2	2.4	2		○					●

● : Line up

Reference pages: EP: Internal toolholder → **D034** -, Boring bar tool → **K201** -, Top-borer tool → **K202**
 SP: Internal toolholder → **D041** -, Cartridge → **K181** -

CBN Insert POSITIVE TYPE

- : Continuous cutting
- ◐ : Light interrupted cutting
- ◑ : Heavy interrupted cutting

SP



Square Positive 11° with hole

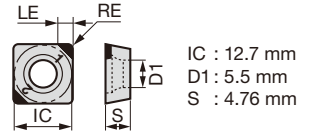

K	Cast iron	●																		
S	Superalloy																			
H	Hard material																			
	Sintered metal																			

Application	Designation	Dimension (mm)		No. of corners	Wiper	Standard	Problem													
		RE	LE				Burr	Finak wear	Crater wear	Chipping										
Finishing	2QP-SPGW120408	0.8	2.4	2		○						●								
	2QP-SPGW120412	1.2	2.4	2		○						●								
	2QP-SPGW120416	1.6	2.4	2		○						●								

● : Line up

SP



Square Positive 11° without hole

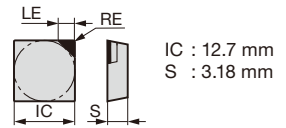

K	Cast iron			●	●															
S	Superalloy																			
H	Hard material	●	●																	
	Sintered metal																			

Application	Designation	Dimension (mm)		No. of corners	Wiper	Standard	Problem													
		RE	LE				Burr	Finak wear	Crater wear	Chipping										
Finishing	2QP-SPMN090304	0.4	2.4	2		○						●	●							
	Q-SPGN090304		2.8	1	○							●								
	2QP-SPGN090308	0.8	2.4	2		○						●		●						
	2QP-SPMN090308		2.4	2	○							●	●		●					
	Q-SPGN090308		2.8	1	○							●								
	2QP-SPGN090312		1.2	2.4	2		○								●					

● : Line up

SP



Square Positive 11° without hole

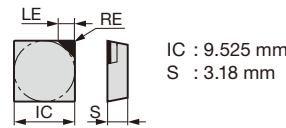

K	Cast iron																			
S	Superalloy																			
H	Hard material	●	●																	
	Sintered metal																			

Application	Designation	Dimension (mm)		No. of corners	Wiper	Standard	Problem													
		RE	LE				Burr	Finak wear	Crater wear	Chipping										
Finishing	SPGN090304-QBN	0.4	4.1	1		○						●								
	SPGN090308-QBN	0.8	4.1	1		○						●								
	SPGN090312-QBN	1.2	4.1	1		○						●								

● : Line up

Reference pages: Internal toolholder → **D041 -** Cartridge → **K181 -**

SP



Square Positive 11° without hole

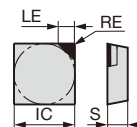

IC : 12.7 mm
 S : 3.18 mm

K	Cast iron																					
S	Superalloy																					
H	Hard material	●●																				
	Sintered metal																					

Application	Designation	Dimension (mm)		No. of corners	Wiper	Standard	Problem				BX360	Line up
		RE	LE				Burr	Flank wear	Crater wear	Chipping		
Finishing	SPGN120308-QBN	0.4	4.1	1		○					●	
	SPGN120312-QBN	0.8	4.1	1		○					●	

● : Line up

TB



Triangular Positive 5° without hole

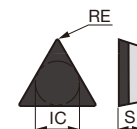

IC : 3.97 mm
 S : 1.59 mm

K	Cast iron																					
S	Superalloy																					
H	Hard material	●●																				
	Sintered metal																					

Application	Designation	Dimension (mm)		No. of corners	Wiper	Standard	Problem				BX360	Line up
		RE	LE				Burr	Flank wear	Crater wear	Chipping		
Finishing	TBGN060104-15-QBN	0.4	-	3		○					●	
	TBGN060108-15-QBN	0.8	-	3		○					●	

● : Line up

TC



Triangular Positive 7° with hole



IC : 5.56 mm
 D1 : 2.5 mm
 S : 2.38 mm

K	Cast iron																					
S	Superalloy																					
H	Hard material	●●																				
	Sintered metal																					

Application	Designation	Dimension (mm)		No. of corners	Wiper	Standard	Problem				BXA10	BXA20	Line up
		RE	LE				Burr	Flank wear	Crater wear	Chipping			
Finishing	3QP-TCGW090202	0.2	2.3	3		○					●	●	
	3QP-TCGW090204	0.4	2.2	3		○					●	●	
	3QP-TCGW090208	0.8	1.9	3		○					●	●	

● : Line up

Reference pages: SP: Internal toolholder → **D042**, Cartridge → **K181 -**
 TC: External toolholder → **C054**, Internal toolholder → **D045**
 J-Series toolholder → **G074 -**, PINZBOHR® → **K178 -**



CBN Insert POSITIVE TYPE

- : Continuous cutting
- ◐ : Light interrupted cutting
- ◑ : Heavy interrupted cutting

TC



Triangular Positive 7° with hole

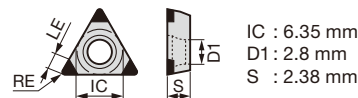

Application	Designation	Dimension (mm)		No. of corners	Wiper	Standard	Problem				BXA10	BXA20	
		RE	LE				Burr	Flak wear	Crater wear	Chipping			
Finishing	3QP-TCGW110202	0.2	2.3	3		○						●	●
	3QP-TCGW110204	0.4	2.2	3		○						●	●
	3QP-TCGW110208	0.8	1.9	3		○						●	●

● : Line up

TC



Triangular Positive 7° with hole

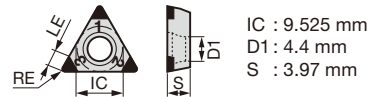

Application	Designation	Dimension (mm)		No. of corners	Wiper	Standard	Problem				BXA10	BXA20	
		RE	LE				Burr	Flak wear	Crater wear	Chipping			
Finishing	3QP-TCGW16T302	0.2	2.3	3		○						●	●
	3QP-TCGW16T304	0.4	2.2	3		○						●	●
	3QP-TCGW16T308	0.8	1.9	3		○						●	●

● : Line up

TP



Triangular Positive 11° with hole

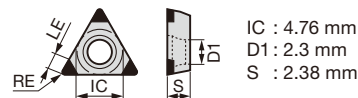

Application	Designation	Dimension (mm)		No. of corners	Wiper	Standard	Problem				BXA10	BXA20	BXM10	BXM20	BXA30	BXA40	BX310	BX330	BX360	BX930					
		RE	LE				Burr	Flak wear	Crater wear	Chipping															
Finishing	3QP-TPGW080202	0.2	2.3	3		○																			
	3QP-TPGW080204		2.2	3		○																			
	3QP-TPMW080204	0.4	2.2	3		○																			
	Q-TPMW080204		2.2	1		○																			
	3QP-TPGW080208	0.8	1.9	3		○																			

● : Line up

Reference pages: TC: External toolholder → **C054**, Internal toolholder → **D045**
 J-Series toolholder → **G074** -, PINZBOHR® → **K178** -
 TP: Internal toolholder → **D046** -, Cartridge → **K181** -
 Boring bar tool → **K199** -, Top-borer tool → **K203**

TP



Triangular Positive 11° with hole

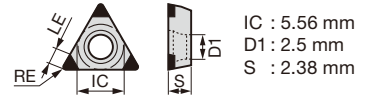

K	Cast iron																				
S	Superalloy																				
H	Hard material	●	◐	◐	◐	◐	◐	◐	◐	◐	◐	◐	◐	◐	◐	◐	◐	◐	◐	◐	◐
	Sintered metal																				

Application	Designation	Dimension (mm)		No. of corners	Wiper	Standard	Problem				BXA10	BXA20	BXM10	BXM20	BXA30	BXA40	BX310	BX330	BX360	BX930		
		RE	LE				Burr	Finak wear	Crater wear	Chipping												
Finishing	3QP-TPGW090202	0.2	2.3	3	○					●	●											
	3QP-TPMW090202		2.3	3	○													●	●	●		
	Q-TPMW090202		2.4	1	○														●			
	3QP-TPGW090204	0.4	2.2	3	○					●	●	●	●	●	●							
	3QP-TPMW090204		2.2	3	○													●	●	●	●	
	Q-TPMW090204		2.3	1	○														●			
	3QP-TPGW090208	0.8	1.9	3	○						●	●										

● : Line up

TP



Triangular Positive 11° with hole

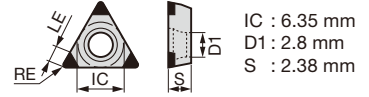

K	Cast iron																				
S	Superalloy																				
H	Hard material	●	◐	◐	◐	◐	◐	◐	◐	◐	◐	◐	◐	◐	◐	◐	◐	◐	◐	◐	◐
	Sintered metal																		◐		

Application	Designation	Dimension (mm)		No. of corners	Wiper	Standard	Problem				BXA10	BXA20	BXM10	BXM20	BXA30	BXA40	BX310	BX330	BX360	BX470	BX930	
		RE	LE				Burr	Finak wear	Crater wear	Chipping												
Finishing	3QP-TPGW110202	0.2	2.3	3	○					●	●											
	3QP-TPMW110202		2.3	3	○													●	●	●		●
	Q-TPMW110202		2.4	1	○														●			
	3QP-TPGW110204	0.4	2.2	3	○					●	●	●	●	●	●						●	●
	3QP-TPMW110204		2.2	3	○													●	●	●		●
	Q-TPMW110204		2.2	1	○														●			
	3QP-TPGW110208	0.8	1.9	3	○						●	●									●	

● : Line up

Reference pages: Internal toolholder → D046 - Cartridge → K181 -
 Boring bar tool → K199 - Top-borer tool → K203



CBN Insert POSITIVE TYPE

- : Continuous cutting
- ◐ : Light interrupted cutting
- ⊕ : Heavy interrupted cutting

TP



Triangular Positive 11° with hole



IC : 6.35 mm
D1 : 3.4 mm
S : 3.18 mm

K	Cast iron																	●	●	●	
S	Superalloy																		●		
H	Hard material	●	●	⊕	●	●	●	●	●	●	●	●	●								
	Sintered metal																	●	⊕		

Application	Designation	Dimension (mm)		No. of corners	Wiper	Standard	Problem				BXA10	BXA20	BR35F	BXM10	BXM20	BXA30	BXA40	BX310	BX330	BX360	BX470	BX480	BX910	BX930	
		RE	LE				Burr	Flank wear	Crater wear	Chipping															
Precision finishing	3QP-TPGW110302-LF	0.2	2.3	3			○					●	●												
	3QP-TPGW110302-L		2.3	3			○		○			●	●												
	3QP-TPGW110304F	0.4	2.2	3			○																●		
	3QP-TPGW110304-LF		2.2	3			○		○			●	●												
	3QP-TPGW110304-L	0.8	2.2	3																					
	3QP-TPGW110308F		1.9	3			○																●		
	3QP-TPGW110308-LF	1.9	3			○																			
Finishing	3QP-TPGW110302	0.2	2.3	3		○						●	●			●	●	●					●		
	3QP-TPMW110302		2.3	3		○													●	●	●			●	
	3QP-TPGW110302-LC	2.3	3					○			●	●													
	3QP-TPGW110304	0.4	2.2	3		○						●	●		●	●	●					●	●		
	3QP-TPGW110304SR		2.2	3		○							●												
	3QP-TPMW110304	2.2	3		○													●	●	●				●	
	Q-TPMW110304	2.2	1		○														●						
	3QP-TPGW110304-LC	2.2	3						○			●	●												
	3QP-TPGW110308	0.8	1.9	3		○						●	●		●	●	●	●					●	●	●
	3QP-TPGW110308SR		1.9	3		○								●											
	3QP-TPMW110308	1.9	3		○														●	●	●			●	
	Q-TPMW110308	1.9	1		○															●					
	3QP-TPGW110308-LC	1.9	3						○			●	●												
	Medium cutting	3QP-TPGW110302-H	0.2	2.3	3							○		●	●										
		3QP-TPGW110304-H		2.2	3									●											
		3QP-TPGW110304HC	0.4	2.2	3									○											
3QP-TPGW110308-H		1.9		3											●										
3QP-TPGW110308HC		0.8	1.9	3										○											

● : Line up

TP with chipbreaker



Triangular Positive 11° with hole



IC : 6.35 mm
D1 : 3.4 mm
S : 3.18 mm

K	Cast iron																								
S	Superalloy																								
H	Hard material	●	●	⊕	●																				
	Sintered metal																								

Application	Designation	Dimension (mm)		No. of corners	Wiper	Standard	Problem				BXA10	BXA20	BR35F	BXM10											
		RE	LE				Burr	Flank wear	Crater wear	Chipping															
Precision finishing	3QP-TPGT110304-HP	0.4	2.2	3		○							●	●											
	3QP-TPGT110304-HS		2.1	3		○								●	●										
	3QP-TPGT110308-HP	0.8	1.9	3		○									●										
	3QP-TPGT110308-HS		1.8	3		○										●									

● : Line up

Reference pages: Internal toolholder → **D046** - Cartridge → **K181** -
 Boring bar tool → **K199** - Top-borer tool → **K203**

TP



Triangular Positive 11° with hole



IC : 7.94 mm
 D1 : 3.4 mm
 S : 3.18 mm

Application	Designation	Dimension (mm)		No. of corners	Wiper	Standard	Problem				BXA10	BXA20	BXM10	BXM20	BXA30	BXA40	BX310	BX330	BX360	BX480	BX930		
		RE	LE				Burr	Flak wear	Crater wear	Chipping													
Finishing	3QP-TPGW130302	0.2	2.3	3	O																		
	3QP-TPMW130302		2.3	3																			
	Q-TPMW130302		2.4	1																			
	3QP-TPGW130304	0.4	2.2	3	O																		
	3QP-TPMW130304		2.2	3																			
	Q-TPMW130304		2.3	1																			
	3QP-TPGW130308	0.8	1.9	3	O																		

● : Line up

TP



Triangular Positive 11° with hole



IC : 9.525 mm
 D1 : 4.4 mm
 S : 3.97 mm

Application	Designation	Dimension (mm)		No. of corners	Wiper	Standard	Problem				BXA10	BXA20	BXM10	BXM20	BXA30	BXA40	BX310	BX330	BX360	BX480	BX930		
		RE	LE				Burr	Flak wear	Crater wear	Chipping													
Finishing	3QP-TPGW16T302	0.2	2.3	3	O																		
	3QP-TPGW16T304		2.2	3																			
	3QP-TPMW16T304	0.4	2.2	3	O																		
	Q-TPGW16T304		2.3	1																			
	3QP-TPGW16T308	0.8	1.9	3	O																		
	3QP-TPMW16T308		1.9	3																			

● : Line up

Reference pages: Internal toolholder → D046 - Cartridge → K181 -
 Boring bar tool → K199 - Top-borer tool → K203

CBN Insert POSITIVE TYPE

● : Continuous cutting
 ● : Light interrupted cutting
 ✖ : Heavy interrupted cutting

TP



Triangular Positive 11° with hole

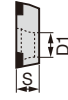

IC : 9.525 mm
 D1 : 4.4 mm
 S : 4.76 mm

Application	Designation	Dimension (mm)		No. of corners	Wiper	Standard	Problem				BXA10	BXA20	BXM10	BXM20	BXA30	BXA40	BX310	BX330	BX360	BX930		
		RE	LE				Burr	Flak wear	Crater wear	Chipping												
Finishing	3QP-TPGW160402	0.2	2.3	3		○					●	●										
	3QP-TPGW160404		2.2	3		○					●	●										
	3QP-TPMW160404	0.4	2.2	3		○											●	●	●	●		
	Q-TPMW160404		2.3	1		○												●				
	3QP-TPGW160408	0.8	1.9	3		○					●	●		●	●							
	3QP-TPMW160408		1.9	3		○											●	●	●	●		
Q-TPMW160408	2		1		○												●					
Medium cutting	3QP-TPGW160402-H	0.2	2.3	3						○	●	●										
	3QP-TPGW160404-H	0.4	2.2	3						○	●	●										
	3QP-TPGW160408-H	0.8	1.9	3						○	●	●										

● : Line up

TP



Triangular Positive 11° without hole



IC : 6.35 mm
 S : 3.18 mm

Application	Designation	Dimension (mm)		No. of corners	Wiper	Standard	Problem				BX330	BX360	BX480	BX910	BX930						
		RE	LE				Burr	Flak wear	Crater wear	Chipping											
Finishing	3QP-TPGN110302	0.2	2.3	3		○															
	3QP-TPMN110302		2.3	3		○					●	●			●						
	3QP-TPGN110304	0.4	2.2	3		○															
	3QP-TPMN110304		2.2	3		○					●	●			●						
	Q-TPGN110304		2.2	1		○					●										
	3QP-TPGN110308	0.8	1.9	3		○								●	●						
	3QP-TPMN110308		1.9	3		○					●	●			●						
	Q-TPGN110308		2.2	1		○					●										
	3QP-TPGN110312	1.2	2.4	3		○									●						

● : Line up

Reference pages: Internal toolholder → D046 - Cartridge → K181 -
 Boring bar tool → K199 - Top-borer tool → K203

TP



Triangular Positive 11° without hole



K Cast iron	●●	●																					
S Superalloy	●●																						
H Hard material	●●																						
Sintered metal	✱																						

Application	Designation	Dimension (mm)		No. of corners	Wiper	Standard	Problem					BX330	BX360	BX480	BX930
		RE	LE				Burr	Flank wear	Crater wear	Chipping					
Finishing	3QP-TPGN160304	0.4	2.2	3		○							●		
	3QP-TPMN160304		2.2	3	○					●	●		●		
	Q-TPGN160304	2.3	1	○						●					
	3QP-TPGN160308	0.8	1.9	3	○							●			
	3QP-TPMN160308		1.9	3	○					●	●		●		
Q-TPGN160308	1.9	1	○						●						

● : Line up

TP



Triangular Positive 11° with hole

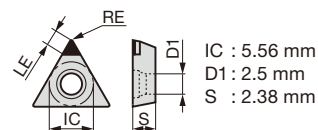

K Cast iron																							
S Superalloy																							
H Hard material	●●																						
Sintered metal																							

Application	Designation	Dimension (mm)		No. of corners	Wiper	Standard	Problem					BX360
		RE	LE				Burr	Flank wear	Crater wear	Chipping		
Finishing	TPGW090202-QBN	0.2	3.3	1		○					●	
	TPGW090204-QBN	0.4	3.2	1		○					●	

● : Line up

TP



Triangular Positive 11° with hole

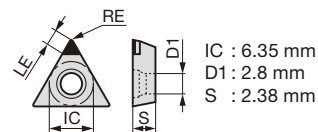

K Cast iron																							
S Superalloy																							
H Hard material	●●																						
Sintered metal																							

Application	Designation	Dimension (mm)		No. of corners	Wiper	Standard	Problem					BX360
		RE	LE				Burr	Flank wear	Crater wear	Chipping		
Finishing	TPGW110202-QBN	0.2	3.9	1		○					●	
	TPGW110204-QBN	0.4	3.7	1		○					●	

● : Line up

Reference pages: Internal toolholder → **D046 -** Cartridge → **K181 -**
 Boring bar tool → **K199 -** Top-borer tool → **K203**

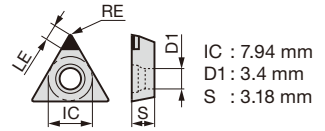

TP



Triangular Positive 11° with hole

K	Cast iron																					
S	Superalloy																					
H	Hard material	●	◐																			
	Sintered metal																					

Application	Designation	Dimension (mm)		No. of corners	Wiper	Standard	Problem				BX360
		RE	LE				Burr	Flank wear	Crater wear	Chipping	
Finishing	TPGW130302-QBN	0.2	3.9	1		○					●
	TPGW130304-QBN	0.4	3.7	1		○					●

● : Line up

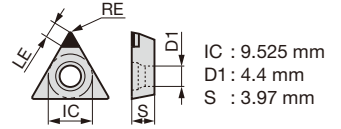

TP



Triangular Positive 11° with hole

K	Cast iron																				
S	Superalloy																				
H	Hard material	●	◐																		
	Sintered metal																				

Application	Designation	Dimension (mm)		No. of corners	Wiper	Standard	Problem				BX360
		RE	LE				Burr	Flank wear	Crater wear	Chipping	
Finishing	TPGW16T302-QBN	0.2	4.4	1		○					●
	TPGW16T304-QBN	0.4	4.2	1		○					●
	TPGW16T308-QBN	0.8	4	1		○					●

● : Line up

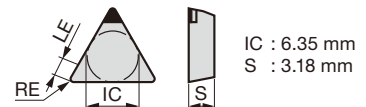

TP



Triangular Positive 11° without hole

K	Cast iron																				
S	Superalloy																				
H	Hard material	●	◐																		
	Sintered metal																				

Application	Designation	Dimension (mm)		No. of corners	Wiper	Standard	Problem				BX360
		RE	LE				Burr	Flank wear	Crater wear	Chipping	
Finishing	TPGN110304-QBN	0.4	3.7	1		○					●
	TPGN110308-QBN	0.8	3.5	1		○					●

● : Line up

Reference pages: Internal toolholder → **D046** - Cartridge → **K181** -
Boring bar tool → **K199** - Top-borer tool → **K203**

TP



Triangular Positive 11° without hole

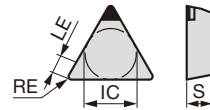

IC : 9.525 mm
 S : 3.18 mm

Application	Designation	Dimension (mm)		No. of corners	Wiper	Standard	Problem				BX360	
		RE	LE				Burr	Flank wear	Crater wear	Chipping		
Finishing	TPGN160304-QBN	0.4	4.2	1		○					●●	
	TPGN160308-QBN	0.8	4	1		○					●●	

TP



Triangular Positive 11° with hole

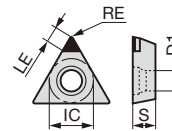

IC : 5.56 mm
 D1 : 3.2 mm
 S : 2.38 mm

Application	Designation	Dimension (mm)		No. of corners	Wiper	Standard	Problem				BX360	
		RE	LE				Burr	Flank wear	Crater wear	Chipping		
Finishing	TPGA090202-QBN	0.2	3.1	1		○					●●	
	TPGA090204-QBN	0.4	2.9	1		○					●●	

Tungaloy's standard hole specification (ISO non-compliant)

TP



Triangular Positive 11° with hole

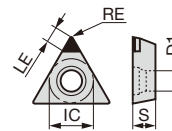

IC : 6.35 mm
 D1 : 3 mm
 S : 2.38 mm

Application	Designation	Dimension (mm)		No. of corners	Wiper	Standard	Problem				BX360	
		RE	LE				Burr	Flank wear	Crater wear	Chipping		
Finishing	TPGA110202-QBN	0.2	3.9	1		○					●●	
	TPGA110204-QBN	0.4	3.7	1		○					●●	

Tungaloy's standard hole specification (ISO non-compliant)

Reference pages: Mounting hole specification → **B146**
 Internal toolholder → **D046 -** Cartridge → **K181 -**
 Boring bar tool → **K199 -** Top-borer tool → **K203**

CBN Insert POSITIVE TYPE

- : Continuous cutting
- ◐ : Light interrupted cutting
- ◑ : Heavy interrupted cutting

TP



Triangular Positive 11° with hole

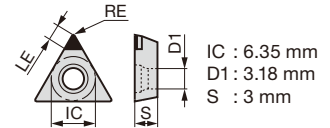

Application	Designation	Dimension (mm)		No. of corners	Wiper	Standard	Problem				BX360
		RE	LE				Burr	Flank wear	Crater wear	Chipping	
Finishing	TPGA110302-QBN	0.2	3.9	1		○					●
	TPGA110304-QBN	0.4	3.7	1		○					●

Tungaloy's standard hole specification (ISO non-compliant)

● : Line up

TP



Triangular Positive 11° with hole

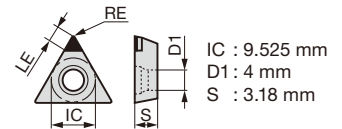

Application	Designation	Dimension (mm)		No. of corners	Wiper	Standard	Problem				BX360
		RE	LE				Burr	Flank wear	Crater wear	Chipping	
Finishing	TPGA160302-QBN	0.2	4.4	1		○					●
	TPGA160304-QBN	0.4	4.2	1		○					●
	TPGA160308-QBN	0.8	4	1		○					●

Tungaloy's standard hole specification (ISO non-compliant)

● : Line up

Reference pages: Mounting hole specification → **B146**
 Internal toolholder → **D046 -** Cartridge → **K181 -**
 Boring bar tool → **K199 -** Top-borer tool → **K203**

- : Continuous cutting
- ◐ : Light interrupted cutting
- ✱ : Heavy interrupted cutting

VB

 **35° Rhombic Positive 5° with hole**

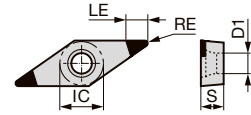

IC : 6.35 mm
D1 : 2.8 mm
S : 2.38 mm

Application	Designation	Dimension (mm)		No. of corners	Wiper	Standard	Problem															
		RE	LE				Burr	Finak wear	Crater wear	Chipping												
Finishing	2QP-VBGW110202	0.2	3.5	2		○					●	●										
	2QP-VBGW110204	0.4	3.1	2		○					●	●										
	2QP-VBGW110208	0.8	2.2	2		○					●	●										

● : Line up

VB

 **35° Rhombic Positive 5° with hole**

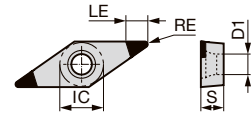

IC : 6.35 mm
D1 : 2.8 mm
S : 3.18 mm

Application	Designation	Dimension (mm)		No. of corners	Wiper	Standard	Problem																	
		RE	LE				Burr	Finak wear	Crater wear	Chipping														
Precision finishing	2QP-VBGW110302-LF	0.2	3.5	2		○					●	●												
	2QP-VBGW110302-L		3.5	2			○		○			●	●											
	2QP-VBGW110304-LF	0.4	3.1	2		○					●	●												
	2QP-VBGW110304-L		3.1	2			○		○			●	●											
	2QP-VBGW110308-LF	0.8	2.2	2		○						●	●											
	2QP-VBGW110308-L		2.2	2			○		○			●	●											
Finishing	2QP-VBGW110301	0.1	3.7	2		○					●	●												
	2QP-VBGW110302	0.2	3.5	2		○					●	●												
	2QP-VBGW110302-LC		3.5	2					○			●	●											
	2QP-VBGW110304	0.4	3.1	2		○					●	●			●	●	●	●						
	2QP-VBGW110304SR		3.1	2		○									●									
	2QP-VBMW110304		3.1	2		○														●	●	●	●	
	2QP-VBGW110304-LC	0.8	3.1	2		○					●	●												
	2QP-VBGW110308		2.2	2		○						●	●			●	●	●	●					
	2QP-VBGW110308SR		2.2	2		○										●								
	2QP-VBMW110308		2.2	2		○															●	●	●	●
	2QP-VBGW110308-LC	2.2	2						○			●	●											

● : Line up

CBN Insert POSITIVE TYPE

- : Continuous cutting
- ◐ : Light interrupted cutting
- ◑ : Heavy interrupted cutting

VB with chipbreaker

 **35° Rhombic
Positive 5°
with hole**

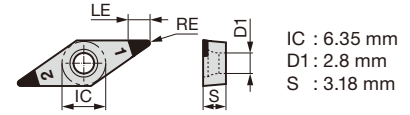

K	Cast iron																					
S	Superalloy																					
H	Hard material	●	●●	●																		
	Sintered metal																					

Application	Designation	Dimension (mm)			No. of corners	Wiper	Standard	Problem														
		RE	LE					Burr	Flank wear	Crater wear	Chipping	BXA10	BXA20	BXM10								
Precision finishing	2QP-VBGT110304-HP	0.4	3	2		○					●	●	●									
	2QP-VBGT110304-HS		3	2		○					●	●	●									
	2QP-VBGT110308-HP	0.8	2.2	2		○					●	●	●									
	2QP-VBGT110308-HS		2.2	2		○					●	●	●									

● : Line up

VB
 **35° Rhombic
Positive 5°
with hole**

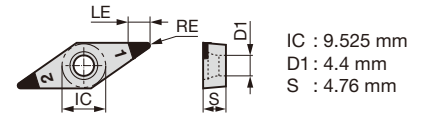

K	Cast iron																					
S	Superalloy																					
H	Hard material	●	●●	*	●	●●	●	●●	●	●●	●	●●										
	Sintered metal																					

Application	Designation	Dimension (mm)			No. of corners	Wiper	Standard	Problem														
		RE	LE					Burr	Flank wear	Crater wear	Chipping	BXA10	BXA20	BR35F	BXM10	BXM20	BXA30	BXA40	BX310	BX330	BX360	
Precision finishing	2QP-VBGW160402-LF	0.2	3.5	2		○					●	●										
	2QP-VBGW160402-L		3.5	2		○					●	●										
	2QP-VBGW160404-LF	0.4	3.1	2		○					●	●										
	2QP-VBGW160404-L		3.1	2		○					●	●										
	2QP-VBGW160408-LF	0.8	2.2	2		○					●	●										
	2QP-VBGW160408-L		2.2	2		○					●	●										
Finishing	2QP-VBGW160402	0.2	3.5	2		○					●	●										
	2QP-VBGW160402-LC		3.5	2			○				●	●										
	2QP-VBGW160404	0.4	3.1	2		○					●	●	●	●	●	●						
	2QP-VBGW160404SR		3.1	2		○							●									
	2QP-VBMW160404		3.1	2		○											●	●	●			
	2QP-VBGW160404-LC		3.1	2						○	●	●										
	2QP-VBGW160408	0.8	2.2	2		○					●	●	●	●	●	●						
	2QP-VBGW160408SR		2.2	2		○							●									
	2QP-VBMW160408		2.2	2		○											●	●	●			
	2QP-VBGW160408-LC		2.2	2						○												
	2QP-VBGW160412	1.2	3	2		○					●	●										
	Medium cutting	2QP-VBGW160402-H	0.2	3.5	2								●									
2QP-VBGW160404-H		3.1		2								●										
2QP-VBGW160404HC		0.4	3.1	2										●								
2QP-VBGW160408-H			2.2	2										●								
2QP-VBGW160408HC		0.8	2.2	2										●								

● : Line up

Reference pages: VB: Internal toolholder → **D059 -**, J-Series toolholder → **G062 -**
VC: External toolholder → **C048 -**, Internal toolholder → **D039 -**, TungCap → **K015 -**

VB with chipbreaker

 **35° Rhombic Positive 5° with hole**

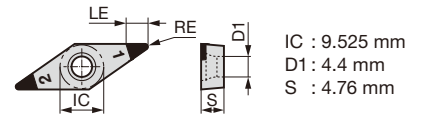

Application	Designation	Dimension (mm)		No. of corners	Wiper	Standard	Problem				BXA10	BXA20	BXM10
		RE	LE				Burr	Flank wear	Crater wear	Chipping			
		Precision finishing	2QP-VBGT160404-HP				0.4	3	2	○			
	2QP-VBGT160404-HS		3	2	○					●	●	●	
	2QP-VBGT160408-HP	0.8	2.2	2	○					●	●	●	
	2QP-VBGT160408-HS		2.2	2	○					●	●	●	

VC

 **35° Rhombic Positive 7° with hole**

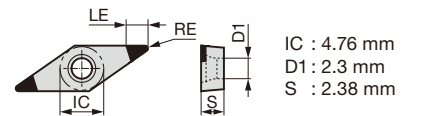

Application	Designation	Dimension (mm)		No. of corners	Wiper	Standard	Problem				BXA10	BXA20
		RE	LE				Burr	Flank wear	Crater wear	Chipping		
		Finishing	2QP-VCGW080202				0.2	3.5	2	○		
	2QP-VCGW080204	0.4	3.1	2	○					●	●	
	2QP-VCGW080208	0.8	2.2	2	○					●	●	

VC

 **35° Rhombic Positive 7° with hole**

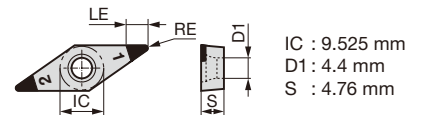

Application	Designation	Dimension (mm)		No. of corners	Wiper	Standard	Problem				BXA10	BXA20	BXM10	BXM20	BXA40	BX330	BX360	BX815	BX930	
		RE	LE				Burr	Flank wear	Crater wear	Chipping										
		Precision finishing	2QP-VCGW160408-E				0.8	2.2	2	○										
	2QP-VCGW160408-LT		2.2	2					○											
	2QP-VCGW160412-E	1.2	3	2	○															
	2QP-VCGW160412-LT		3	2					○											
Finishing	2QP-VCGW160402	0.2	3.5	2	○					●	●									
	2QP-VCGW160404	0.4	3.1	2	○					●	●	●	●	●						
	2QP-VCMW160404		3.1	2	○										●	●			●	
	2QP-VCGW160408	0.8	2.2	2	○					●	●									
Medium cutting	2QP-VCGW160402-H	0.2	3.5	2					○	●	●									
	2QP-VCGW160404-H	0.4	3.1	2					○	●	●									
	2QP-VCGW160408-H	0.8	2.2	2					○	●	●									



Negative
Positive

CBN Insert POSITIVE TYPE

● : Continuous cutting
● : Light interrupted cutting
* : Heavy interrupted cutting

WX

80° Trigon with hole

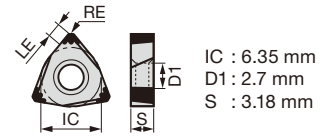

Application	Designation	Dimension (mm)				Wiper	Standard	Problem				BXA10	BXA20	BR35F	
		RE	LE	No. of corners	Standard			Burr	Flak wear	Crater wear	Chipping				
Finishing	6QS-WXGQ040302SPR	0.2	1.8	6	○					●	●	●			
	6QS-WXGQ040302SPL		1.8	6	○					●	●	●			
	6QS-WXGQ040304SPR	0.4	1.8	6	○					●	●	●			
	6QS-WXGQ040304SPL		1.8	6	○					●	●	●			
	6QS-WXGQ040308SPR	0.8	1.7	6	○					●	●	●			
	6QS-WXGQ040308SPL		1.7	6	○					●	●	●			

● : Line up

C
D
E
F
G
R
S
T
V
W
Y
OTHERS

WX with chipbreaker

80° Trigon with hole

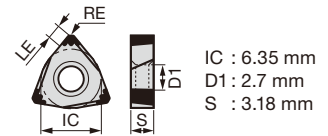

Application	Designation	Dimension (mm)				Wiper	Standard	Problem				BXA10	BXA20	BR35F	
		RE	LE	No. of corners	Standard			Burr	Flak wear	Crater wear	Chipping				
Precision finishing	6QS-WXGU040304R-HP	0.4	1.8	6	○					●	●	●			
	6QS-WXGU040304L-HP		1.8	6	○					●	●	●			
	6QS-WXGU040308R-HP	0.8	1.7	6	○					●	●	●			
	6QS-WXGU040308L-HP		1.7	6	○					●	●	●			

● : Line up

Reference pages: External toolholder → **C029** - Internal toolholder → **D023**
J-Series toolholder → **G045** -

CN



80° Rhombic with hole

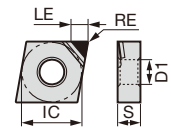

IC : 12.7 mm
 D1 : 5.16 mm
 S : 4.76 mm

Application	Designation	Dimension (mm)		No. of corners	Chipbreaker	Material														
		RE	LE			N Non-ferrous	●●	●●	●●											
Finishing	1QP-CNMM120402	0.2	2.8	1	○	●●														
	CNMM120402-DIA		3.5	1	○		●●													
	1QP-CNMM120404	0.4	2.8	1	○	●●														
	CNMM120404-DIA		3.5	1	○		●●													
	CNGA120404-DIA		3.5	1				●●												
CNGA120408-DIA	0.8	2.8	1				●●													

DN



55° Rhombic with hole

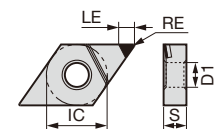

● : Line up
 IC : 12.7 mm
 D1 : 5.16 mm
 S : 4.76 mm

Application	Designation	Dimension (mm)		No. of corners	Chipbreaker	Material														
		RE	LE			N Non-ferrous	●●	●●	●●											
Finishing	DNMM150402-DIA	0.2	3.3	1	○	●●														
	DNMM150404-DIA	0.4	3.1	1	○	●●														
	DNGA150404-DIA		3.1	1			●●	●●												
	DNGA150408-DIA	0.8	2.8	1				●●												

SN



Square with hole

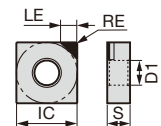

● : Line up
 IC : 12.7 mm
 D1 : 5.16 mm
 S : 4.76 mm

Application	Designation	Dimension (mm)		No. of corners	Chipbreaker	Material														
		RE	LE			N Non-ferrous	●●													
Finishing	SNGA120404-DIA	0.4	3.6	1		●●														
	SNGA120408-DIA	0.8	3.6	1		●●														

Reference pages: CN: External toolholder → **C015 -**, Internal toolholder → **D025 -**
 J-Series toolholder → **G050**, TungCap → **K008 -**
 PINZBOHR® → **K178 -**, Cartridge → **K181 -**
 DN: External toolholder → **C034 -**, Internal toolholder → **D069 -**
 J-Series toolholder → **G068**, TungCap → **C034 -**, **K012 -**
 SN: External toolholder → **C101 -**, Internal toolholder → **D043 -**
 Cartridge → **K181 -**

PCD Insert NEGATIVE TYPE

- : Continuous cutting
- ◐ : Light interrupted cutting
- ◑ : Heavy interrupted cutting

SN

 **Square without hole**

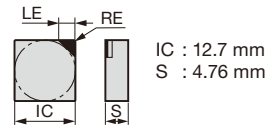

Application	Designation	Dimension (mm)		No. of corners	Chipbreaker															
		RE	LE			1	DX140													
Finishing	SNGN120408-DIA	0.8	3.6	1	●	●														

● : Line up

TN

 **Triangular with hole**

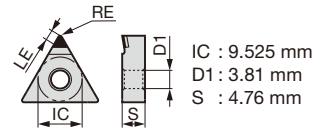

Application	Designation	Dimension (mm)		No. of corners	Chipbreaker																
		RE	LE			1	DX110	DX120	DX140	DX160											
Finishing	1QP-TNMM160402	0.2	2.7	1	○	●															
	TNMM160402-DIA		3.3	1	○		●														
	1QP-TNMM160404	0.4	2.6	1	○	●															
	TNMM160404-DIA		3.2	1	○		●														
	TNGA160404-DIA		3.2	1					●	●											
	TNGA160408-DIA		0.8	2.9	1					●	●										

● : Line up

VN

 **35° Rhombic with hole**

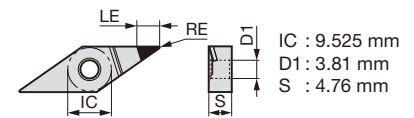

Application	Designation	Dimension (mm)		No. of corners	Chipbreaker															
		RE	LE			1	DX120													
Finishing	VNMM160402-DIA	0.2	4.8	1	○	●														
	VNMM160404-DIA	0.4	4.4	1	○	●														
	VNMM160408-DIA	0.8	3.6	1	○	●														

● : Line up

Reference pages: SN: External toolholder → **C101** -, Internal toolholder → **D043** -, Cartridge → **K181** -
 TN: External toolholder → **C032** -, Internal toolholder → **D049** -, Cartridge → **K181** -
 VN: External toolholder → **C041** -, Internal toolholder → **D074** -, TungCap → **C042** -, **K014** -

CC



80° Rhombic Positive 7° with hole

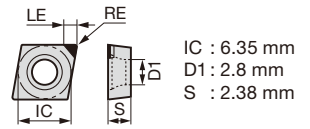

IC : 6.35 mm
 D1 : 2.8 mm
 S : 2.38 mm

Application	Designation	Dimension (mm)		No. of corners	Chipbreaker	DX110	DX120	DX140	DX160	DX180	DX200	DX250	DX300	DX350	DX400	DX450	DX500	DX600	DX700	DX800	DX900	DX1000	DX1200	DX1500	DX2000	DX2500	DX3000	DX4000	DX5000	DX6000	DX8000	DX10000
		RE	LE																													

Application	Designation	Dimension (mm)		No. of corners	Chipbreaker	DX110	DX120	DX140	DX160	DX180	DX200	DX250	DX300	DX350	DX400	DX450	DX500	DX600	DX700	DX800	DX900	DX1000	DX1200	DX1500	DX2000	DX2500	DX3000	DX4000	DX5000	DX6000	DX8000	DX10000		
		RE	LE																															
Finishing	CCGW060200-DIA	0.05	2.4	1																														
	CCMT060202-DIA	0.2	2.4	1	○		●																											
	CCGW060202-DIA		2.4	1					●																									
	1QP-CCGT060204-NS		3.1	1	○		●																											
	1QP-CCMT060204	0.4	2.4	1	○		●																											
	CCMT060204-DIA		2.4	1	○			●																										
	CCGW060204-DIA		2.4	1						●																								

● : Line up

CC



80° Rhombic Positive 7° with hole

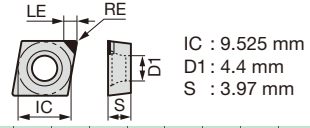

IC : 9.525 mm
 D1 : 4.4 mm
 S : 3.97 mm

Application	Designation	Dimension (mm)		No. of corners	Chipbreaker	DX110	DX120	DX140	DX160	DX180	DX200	DX250	DX300	DX350	DX400	DX450	DX500	DX600	DX700	DX800	DX900	DX1000	DX1200	DX1500	DX2000	DX2500	DX3000	DX4000	DX5000	DX6000	DX8000	DX10000
		RE	LE																													

Application	Designation	Dimension (mm)		No. of corners	Chipbreaker	DX110	DX120	DX140	DX160	DX180	DX200	DX250	DX300	DX350	DX400	DX450	DX500	DX600	DX700	DX800	DX900	DX1000	DX1200	DX1500	DX2000	DX2500	DX3000	DX4000	DX5000	DX6000	DX8000	DX10000		
		RE	LE																															
Finishing	CCMT09T302-DIA	0.2	2.4	1	○																													
	CCGW09T302-DIA		3.5	1				●																										
	1QP-CCGT09T304-NS	0.4	3.1	1	○		●																											
	1QP-CCMT09T304		2.4	1	○		●																											
	CCMT09T304-DIA		2.4	1	○			●																										
	CCGW09T304-DIA	3.5	1					●	●																									
	1QP-CCGT09T308-NS	0.8	3	1	○		●																											
CCGW09T308-DIA	3.4		1					●																										

● : Line up

CP



80° Rhombic Positive 11° with hole

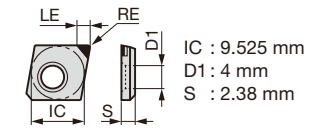

IC : 9.525 mm
 D1 : 4 mm
 S : 2.38 mm

Application	Designation	Dimension (mm)		No. of corners	Chipbreaker	DX140	DX160	DX180	DX200	DX250	DX300	DX350	DX400	DX450	DX500	DX600	DX700	DX800	DX900	DX1000	DX1200	DX1500	DX2000	DX2500	DX3000	DX4000	DX5000	DX6000	DX8000	DX10000
		RE	LE																											

Application	Designation	Dimension (mm)		No. of corners	Chipbreaker	DX140	DX160	DX180	DX200	DX250	DX300	DX350	DX400	DX450	DX500	DX600	DX700	DX800	DX900	DX1000	DX1200	DX1500	DX2000	DX2500	DX3000	DX4000	DX5000	DX6000	DX8000	DX10000		
		RE	LE																													
Finishing	CPGA090202-DIA	0.2	2.4	1		●																										
	CPGA090204-DIA	0.4	2.4	1		●																										

● : Line up

Tungaloy's standard hole specification (ISO non-compliant)

Reference pages: CC: External toolholder → **C030** -, Internal toolholder → **D014** -
 J-Series toolholder → **G040** -, PINZBOHR® → **K178** -

PCD Insert POSITIVE TYPE

- : Continuous cutting
- ◐ : Light interrupted cutting
- ✱ : Heavy interrupted cutting

DC



55° Rhombic Positive 7° with hole

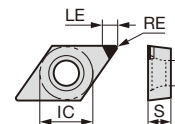

IC : 6.35 mm
D1 : 2.8 mm
S : 2.38 mm

		N Non-ferrous			●●	●●	●●													
Application	Designation	Dimension (mm)		No. of corners	Chipbreaker	DX110	DX120	DX140												
		RE	LE																	
Finishing	DCGW070200-DIA	0.05	2.4	1				●												
	DCMT070202-DIA	0.2	2.3	1	○		●													
	DCGW070202-DIA		2.3	1			●	●												
	1QP-DCGT070204-NS	0.4	3	1	○	●														
	DCMT070204-DIA		2.1	1	○		●													
	DCGW070204-DIA		2.1	1				●												

● : Line up

DC

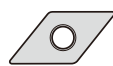

55° Rhombic Positive 7° with hole

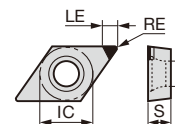

IC : 9.525 mm
D1 : 4.4 mm
S : 3.97 mm

		N Non-ferrous			●●	●●	●●													
Application	Designation	Dimension (mm)		No. of corners	Chipbreaker	DX110	DX120	DX140												
		RE	LE																	
Finishing	DCMT11T302-DIA	0.2	3.2	1	○		●													
	DCGW11T302-DIA		3.2	1			●													
	1QP-DCGT11T304-NS	0.4	3	1	○	●														
	DCMT11T304-DIA		3	1	○		●													
	DCGW11T304-DIA		3	1				●												
	1QP-DCGT11T308-NS	0.8	3	1	○	●														
DCGW11T308-DIA	2.7		1				●													

● : Line up

EP



75° Rhombic Positive 11° with hole

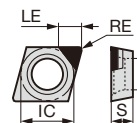

IC : 3.97 mm
D1 : 2.3 mm
S : 1.59 mm

		N Non-ferrous			●●															
Application	Designation	Dimension (mm)		No. of corners	Chipbreaker	DX140														
		RE	LE																	
Finishing	EPGW040102-DIA	0.2	2	1		●														
	EPGW040104-DIA	0.4	1.9	1		●														

● : Line up

Reference pages: DC: External toolholder → C046 -, Internal toolholder → D056 -, J-Series toolholder → G052 -
EP : Internal toolholder → D034 -, Boring bar tool → K201 -, Top-borer tool → K202

SP



Square Positive 11° without hole

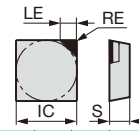

IC : 9.525 mm
S : 3.18 mm

Application	Designation	Dimension (mm)		No. of corners	Chipbreaker	Material / Grade															
		RE	LE			N Non-ferrous ●◐															
Finishing	SPGN090308-DIA	0.8	3.6	1	DX140	●															

● : Line up

SP



Square Positive 11° without hole

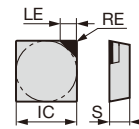

IC : 12.7 mm
S : 3.18 mm

Application	Designation	Dimension (mm)		No. of corners	Chipbreaker	Material / Grade																
		RE	LE			N Non-ferrous ●◐◐																
Finishing	SPGN120302-DIA	0.2	3.6	1	DX140	●																
	SPGN120304-DIA	0.4	3.6	1	DX160	●																
	SPGN120308-DIA	0.8	3.6	1		●	●															

● : Line up

TC



Triangular Positive 7° with hole

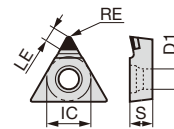

IC : 4.76 mm
D1 : 2.7 mm
S : 2.38 mm

Application	Designation	Dimension (mm)		No. of corners	Chipbreaker	Material / Grade																
		RE	LE			N Non-ferrous ●◐																
Finishing	TCMT080202-DIA	0.2	2.2	1	DX120	●																
	TCMT080204-DIA	0.4	2	1		●																

● : Line up

Reference pages: SP: Internal toolholder → **D041** -, Cartridge → **K181** -
 TC: External toolholder → **C054**, Internal toolholder → **D045**
 J-Series toolholder → **G074** -, PINZBOHR® → **K178** -



PCD Insert POSITIVE TYPE

- : Continuous cutting
- ◐ : Light interrupted cutting
- ✱ : Heavy interrupted cutting

TC



Triangular Positive 7° with hole

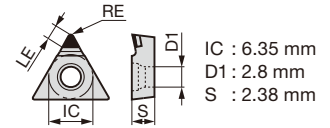

Application	Designation	Dimension (mm)		No. of corners	Chipbreaker	Material																	
		RE	LE			N Non-ferrous ●●																	
		RE	LE																				
Finishing	TCMT110202-DIA	0.2	2.4	1	○	●																	
	TCMT110204-DIA	0.4	2.2	1	○	●																	

● : Line up

TC



Triangular Positive 7° with hole

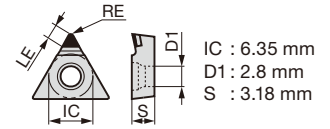

Application	Designation	Dimension (mm)		No. of corners	Chipbreaker	Material																	
		RE	LE			N Non-ferrous ●● ●●																	
		RE	LE																				
Finishing	TCMT110302-DIA	0.2	2.4	1	○	●	●																
	1QP-TCMT110304	0.4	2.2	1	○	●																	
	TCMT110304-DIA		2.2	1	○	●																	

● : Line up

TP



Triangular Positive 11° with hole

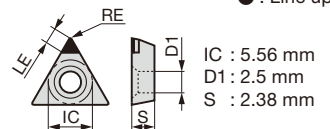

Application	Designation	Dimension (mm)		No. of corners	Chipbreaker	Material																	
		RE	LE			N Non-ferrous ●●																	
		RE	LE																				
Finishing	TPGA090202-DIA	0.2	2.4	1		●																	
	TPGA090204-DIA	0.4	2.2	1		●																	

Tungaloy's standard hole specification (ISO non-compliant)

● : Line up

Reference pages: TC: External toolholder → C054, Internal toolholder → D045

J-Series toolholder → G074 -, PINZBOHR® → K178 -

TP: Mounting hole specification → B146, Internal toolholder → D046 -, Cartridge → K181 -

Boring bar tool → K199 -, Top-borer tool → K203

TP



Triangular Positive 11° with hole

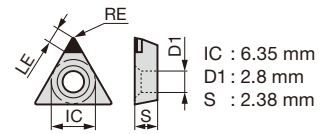

Application	Designation	Dimension (mm)		No. of corners	Chipbreaker	DX140														
		RE	LE																	
Finishing	TPGA110202-DIA	0.2	2.4	1		●														
	TPGA110204-DIA	0.4	2.2	1		●														

Tungaloy's standard hole specification (ISO non-compliant)

● : Line up

TP



Triangular Positive 11° with hole

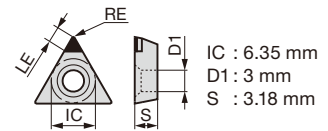

Application	Designation	Dimension (mm)		No. of corners	Chipbreaker	DX140															
		RE	LE																		
Finishing	TPGA110302-DIA	0.2	2.4	1		●															
	TPGA110304-DIA	0.4	2.2	1		●															
	TPGA110308-DIA	0.8	2.9	1		●															

Tungaloy's standard hole specification (ISO non-compliant)

● : Line up

TP



Triangular Positive 11° with hole

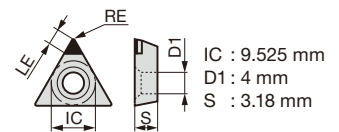

Application	Designation	Dimension (mm)		No. of corners	Chipbreaker	DX140																
		RE	LE																			
Finishing	TPGA160302-DIA	0.2	3.3	1		●																
	TPGA160304-DIA	0.4	3.2	1		●																
	TPGA160308-DIA	0.8	2.9	1		●																

Tungaloy's standard hole specification (ISO non-compliant)

● : Line up

Reference pages: Mounting hole specification → **B146**
 Internal toolholder → **D046 -** Cartridge → **K181 -**
 Boring bar tool → **K199 -** Top-borer tool → **K203**



PCD Insert POSITIVE TYPE

- : Continuous cutting
- ⬤ : Light interrupted cutting
- ✱ : Heavy interrupted cutting

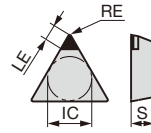

IC : 5.56 mm
S : 2.38 mm

TP



**Triangular
Positive 11°
without hole**

Application	Designation	Dimension (mm)		No. of corners	Chipbreaker	DX140														
		RE	LE				●	⬤	✱	●	⬤	✱								
Finishing	TPGN090204-DIA	0.4	2.2	1		●														

● : Line up

TP



**Triangular
Positive 11°
without hole**

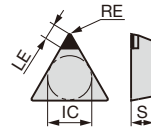

IC : 6.35 mm
S : 3.18 mm

Application	Designation	Dimension (mm)		No. of corners	Chipbreaker	DX120	DX140													
		RE	LE					●	⬤	✱	●	⬤	✱							
Finishing	TPGN110304-DIA	0.4	3.2	1		●	●													
	TPGN110308-DIA	0.8	2.9	1			●													

● : Line up

TP



**Triangular
Positive 11°
without hole**

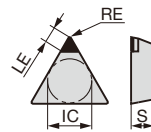

IC : 9.525 mm
S : 3.18 mm

Application	Designation	Dimension (mm)		No. of corners	Chipbreaker	DX120	DX140														
		RE	LE					●	⬤	✱	●	⬤	✱								
Finishing	TPGN160302-DIA	0.2	3.3	1			●														
	TPGN160304-DIA	0.4	3.2	1		●	●														
	TPGN160308-DIA	0.8	2.9	1			●														

● : Line up

Reference pages: Internal toolholder → D047 - Cartridge → K181 -
Boring bar tool → K199 - Top-borer tool → K203

TP



Triangular Positive 11° with hole

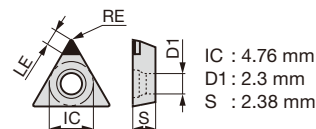

Application	Designation	Dimension (mm)		No. of corners	Chipbreaker	Material																
		RE	LE			1	2	3	4	5	6	7	8	9	10							
Finishing	TPGW080202-DIA	0.2	2.4	1	DX140	●																
	TPGW080204-DIA	0.4	2.3	1		●																

● : Line up

TP



Triangular Positive 11° with hole

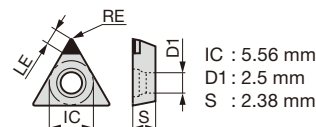

Application	Designation	Dimension (mm)		No. of corners	Chipbreaker	Material																
		RE	LE			1	2	3	4	5	6	7	8	9	10							
Finishing	TPGW090202-DIA	0.2	2.4	1	DX120 DX140	●	●															
	TPGW090204-DIA	0.4	2.2	1		●																

● : Line up

TP



Triangular Positive 11° with hole

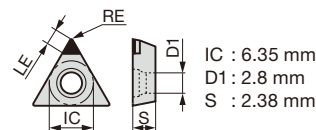

Application	Designation	Dimension (mm)		No. of corners	Chipbreaker	Material																
		RE	LE			1	2	3	4	5	6	7	8	9	10							
Finishing	TPGW110202-DIA	0.2	2.4	1	DX120 DX140	●	●															
	TPGW110204-DIA	0.4	2.2	1		●																

● : Line up

Reference pages: Internal toolholder → **D046** - Cartridge → **K181** -
Boring bar tool → **K199** - Top-borer tool → **K203**

PCD Insert POSITIVE TYPE

- : Continuous cutting
- ◐ : Light interrupted cutting
- ✱ : Heavy interrupted cutting

TP



Triangular Positive 11° with hole

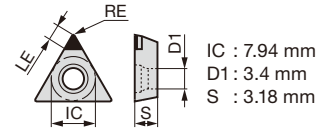

Application	Designation	Dimension (mm)		No. of corners	Chipbreaker																
		RE	LE																		
		RE	LE																		
Finishing	TPGW130302-DIA	0.2	3.3	1		●	●														
	TPGW130304-DIA	0.4	3.2	1			●														

● : Line up

TP



Triangular Positive 11° with hole

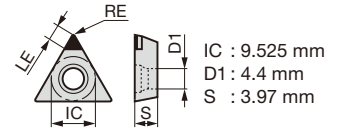

Application	Designation	Dimension (mm)		No. of corners	Chipbreaker																	
		RE	LE																			
		RE	LE																			
Finishing	TPGW16T302-DIA	0.2	3.3	1	DX140	●																
	TPGW16T304-DIA	0.4	3.2	1		●																
	TPGW16T308-DIA	0.8	2.9	1		●																

● : Line up

VC

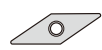

35° Rhombic Positive 7° with hole

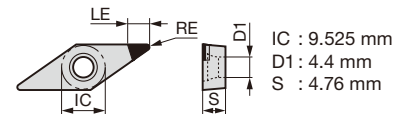

Application	Designation	Dimension (mm)		No. of corners	Chipbreaker																	
		RE	LE																			
		RE	LE																			
Finishing	VCMT160402-DIA	0.2	4.8	1	○	DX110	DX120	DX140														
	VCGW160402-DIA		4.8	1			●		●													
	1QP-VCGT160404-NS	0.4	3	1	○	●																
	VCMT160404-DIA		4.4	1	○		●															
	VCGW160404-DIA	4.4	1					●														
	1QP-VCGT160408-NS	0.8	3	1	○	●																

● : Line up

Reference pages: TP: Internal toolholder → **D046 -**, Cartridge → **K181 -**
 Boring bar tool → **K199 -**, Top-borer tool → **K203**
 VC: External toolholder → **C048 -**, Internal toolholder → **D039 -**, TungCap → **K015 -**

VB



35° Rhombic Positive 5° with hole

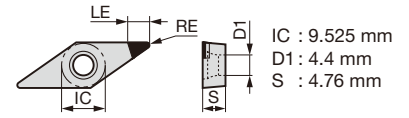

Application	Designation	Dimension (mm)		No. of corners	Chipbreaker	DX110														
		RE	LE																	
Finishing	1QP-VBGT160404-NS	0.4	3	1	○	●														
	1QP-VBGT160408-NS	0.8	3	1	○	●														

● : Line up

Grade **A**

Insert **B**

Toolholder Ext. **C**

Toolholder Int. **D**

Threading **E**

Grooving **F**

Miniature tool **G**

Milling cutter **H**

Endmill **I**

Drilling tool **J**

Tooling System **K**

User's Guide **L**

Index **M**

Technical Guide - Grade Comparison Chart

●CVD Coated Grades for Turning

ISO		Tungaloy	Mitsubishi Carbide	Sumitomo Electric	Sandvik	Kyocera	Moldino	NTK	Kennametal	Seco Tools	Walter	Iscar	TaeguTec	Ceratizit
Classification	Symbol													
P	P01	T9205	UE6105		GC4305	CA510	HG8010		KCP05B KCP05 KCPK05	TP0501	WPP05S	IC8150 IC9150	TT8105 TT8105B	CTCK110
	P10	T9205 T9215	UE6105 UE6110 MC6015 MC6115	AC8015P AC8020P	GC4305 GC4315 GC4415	CA515	HG8010 GM8020	CP7	KCP10B KCP10	TP0501 TP1501	WPP10S WPP10G WPPV10	IC8150 IC9150	TT8115 TT8115B	CTC3110 CTCK120 CTCP115-P
	P20	T9215 T9225	MC6015 MC6025 MC6115 MC6125	AC8015P AC8020P AC8025P	GC4315 GC4325 GC4415 GC4425	CA515 CA525 CA025P	HG8025 GM8020 GM25	CP7	KCP25B KCP25	TP1501 TP2501	WPP20S WPP20G WPPV20	IC8150 IC9150 IC8250 IC9250	TT8125 TT8125B TT5100	CTCP115 CTCP115-P CTCP125 CTCP125-P
	P30	T9225 T9235	MC6025 MC6035 MC6125	AC8025P AC8035P AC8030M	GC4325 GC4335 GC4425	CA530 CA025P	HG8025 GM8035 GM25		KCP30B KCP30	TP2501 TP3501	WPP30S WPP30G	IC8350 IC9350	TT8125 TT8125B TT5100 TT8135 TT8135B	CTCP125 CTCP125-P CTCP135-P
	P40	T9235 T6215	MC6035	AC8035P AC8030M	GC4335	CA530	GM8035 GX30		KCP40B KCP40	TP3501		IC8350 IC9350	TT8135 TT8135B TT7100	
M	M10	T6215	MC7015	AC6020M	GC2015	CA6515			KCM15B KCM15	TM1501		IC9250	TT9215	CTCM120
	M20	T6215	MC7015 MC7025	AC6020M	GC2015 GC2025 GC2220	CA6525	HG8025 GM25		KCM25B KCM25	TM1501 TM2501		IC9350	TT9215 TT9225	CTCM120 CTCM130
	M30	T6215	MC7025 US735	AC6030M	GC2025 GC2035	CA6525	GM8035 GM25 GX30		KCM35B KCM35	TM2501 TM3501		IC9350	TT9225 TT9235	CTCM130
	M40		US735		GC2035		GX30			TM4000			TT9235	
K	K01	T505 T5105	MC5005 MC5105 UC5105	AC405K	GC3005 GC3205	CA4505 CA310	HX3505	CP1	KCK05B KCK05	TK0501		IC5005	TT7005	
	K10	T505 T515 T5105 T5115	MC5015 MC5115 MH515 UC5115	AC4010K AC415K	GC3210 GC3215	CA4515 CA315	HX3515 HG8010	CP1	KCK15B KCK15	TK0501	WKK10S WKV10 WAK10	IC9150 IC5005 IC5010	TT7005 TT7015	CTC3110 CTCK110
	K20	T515 T5115 T5125	MC5015 MC5125 UC5115	AC4015K AC420K	GC3225	CA320	HX3515 GM8020	CP1	KCK20B KCK20	TK1501	WKK20S WKV20 WAK20	IC9150 IC5010	TT7015 TT7025 TT7310	CTCK120 CTCP115
	K30	T5125		AC8025P			HG8025				WAK30	IC4050 IC8150	TT7025	CTCP125

Note: The above table is selected from a publication. We have not obtained approval from each company.

●PVD Coated Grade for Turning

ISO Classification	Symbol	Tungaloy	Mitsubishi Carbide	Sumitomo Electric	Sandvik	Kyocera	Moldino	NTK	Kennametal	Seco Tools	Walter	Iscar	TaeguTec	Ceratizit
P	P01					PR1705								
	P10	AH8005	VP10RT MS6015	AC1030U AC530U ACZ150	GC1105	PR1705 PR930 PR1725	IP2000	VM1 DT4 DM4	KC5010 KCU10	TS2000 CP200		IC807 IC907 IC808 IC908 IC1007	TT4410 TT7010	CTPX710 CTPX715
		AH120 AH725 SH725 AH730 J740 AH8015 AH6225	VP15TF VP20MF VP10RT VP20RT UP20M MS6015	AC1030U AC530U	GC1125	PR1725 PR930 PR1225 PR1025	IP2000	VM1 DT4 DM4 TM4 QM3	KC5025 KCU25 KCS10 KCU10 KC5010	TS2500 CP200		IC807 IC907 IC808 IC908 IC830 IC1010	TT9030 TT4410	CTPX710 CTPX715 CTPM125
	P30	AH120 AH725 AH7025 SH725 SH730 J740 AH8015 AH6225	VP15TF VP20MF VP20RT UP20M MS7025	AC1030U	GC1125	PR1725 PR1225 PR1535 PR1025	IP3000	QM3 TM4	KC5025 KCU25 KCU25	CP500 CP600		IC928 IC528 IC228 IC830 IC1010 IC1030	TT9030 TT8020 TT8010 TT9080 TT7220	CTPM125
		AH120 AH725 AH6225	MS7025			PR1535	IP3000	QM3		CP500 CP600		IC228 IC528 IC1030	TT8020 TT8010 TT4430 TT9020	CTPM125
M	M01										WSM01	IC806 IC1007		
	M10	AH8005 AH6225	VP10RT	AC5005S ACZ150	GC1105 GC1115	PR930 PR1725	IP100S IP050S	VM1 DT4 DM4 ZM3	KC5010 KCU10 KCS10B KCS10	TS2000 TS2500 CP200	WSM10 WSM10S WSM01	IC807 IC907 IC808 IC908 IC1010	*TT4410 TT5080*	CTPM125 CTPX710 CTPX715
		AH8015 AH120 AH7025 AH725 SH725 SH730 AH6225	VP10RT VP15TF VP20MF VP20RT UP20M MS7025 MS9025	AC5015S	GC1115 GC1125	PR930 PR1225 PR1725 PR1025	IP100S IP050S	VM1 DT4 DM4 ST4 TM4 ZM3 QM3	KC5025 KCU25 KCS10 KCU10 KC5010	TS2500 CP200 CP500 CP600	WSM20S	IC808 IC908 IC830 IC1030	TT9030 TT8010 TT4410 TT5080 TT9080	CTPM125 CWN15
	M30	AH120 AH725 SH725 SH730 J740 AH6235	VP15TF VP20MF VP20RT UP20M MP7035 MS7025 MS9025	AC6040M AC1030U AC5025S AC530U	"GC1125 GC2035"	PR1225 PR1535 PR1725 PR1025	IP100S	DT4 DM4 QM3 ST4 TM4 ZM3	KC5025 KCU25	CP500 CP600	WSM30S	IC528 IC228 IC830 IC1030	TT8020 TT4430 TT8010 TT8080 TT7220	CTPM125
		AH6235	MP7035	AC6040M	GC2035	PR1535		ST4 QM3 TM4		CP600		IC228 IC528	TT8010 TT8020	
K	K01	AH110												
	K10	AH110 GH110 AH110	VP10RT	ACZ150					KC5010 KCU10 KCS10B KCS10	TS2000 CP200		IC807 IC907	TT9030 TT7010 TT6080	CTPX715
		AH120 AH7025 AH8015 AH6225	VP10RT VP20RT VP15TF	AC1030U					KC5025 KCU25	TS2500 CP200 TS2000		IC807 IC907 IC808 IC908 IC1007 IC1010	*TT9030 TT7010 TT6080 TT9080	CTPX715
	K30	AH120 GH130	VP15TF VP20RT							CP500		IC807 IC907 IC808 IC908	TT9030	CTPX715
S	S01	AH8005	VP05RT MP9005	AC5005S AC5015S ACZ150		PR005S	JP9105		KCS10B		WSM10S	IC804 IC806	TT3010	
	S10	AH8005 AH8015 AH6225	VP10RT MP9015	AC5005S AC5015S	GC1105	PR015S PR005S	JP9105 JP9115	QM3 ZM3	KC5025 KCU25 KCS10B KCS10 KC5010 KCU10	TS2000 TS2500 CP200 CP500	WSM10S WSM01 WNN10	IC806 IC1007 IC1010	TT3010 TT3020 TT5080	CTPX710 CTPX715
		AH8015 AH7025 AH6225	MP9015 VP20RT MP9025 MS9025	AC5015S AC5025S	GC1115 GC1125	PR015S PR1535	JP9115		KC5025 KCU25 KCS10B	TS2000 TS2500 CP200 CP500 CP600	WSM20S	IC807 IC907 IC808 IC908 IC806 IC1010	TT3020 TT4430 TT9030 TT9080	CTPX710 CTPX715
	S30	AH7025 AH6235	VP20RT MP9025 MS9025	AC5025S	GC1125	PR1535				CP600	WSM30S	IC830 IC928	TT4430 TT8020 TT9030	

Note: The above table is selected from a publication. We have not obtained approval from each company.

Technical Guide - Grade Comparison Chart

●Cermet for Turning

ISO		Tungaloy	Mitsubishi Carbide	Sumitomo Electric	Sandvik	Kyocera	Moldino	NTK	Kennametal	Seco Tools	Walter	Iscar	TaeguTec	Ceratizit
Classification	Symbol													
P	P01	NS520	AP25N VP25N	T1000A		TN610 PV710						IC20N IC520N	PV3010	CTEP10 TCM407
	P10	AT9530 GT9530 J9530	AP25N VP25N NX2525	T1500Z T1500A	CT5015 GC1525	TN610 TN620 PV710 PV720 CCX			KT315 KTP10	TP1020	WCE10	IC20N IC30N IC520N IC530N	PV3010 CT3000	CTEP10 TCM10 TCM407
	P20	AT9530 GT9530 NS9530 J9530	AP25N VP25N VP45N NX2525 NX3035 MP3025	T1500A T1500Z T2500A T2500Z	GC1525	TN620 PV720	CZ25			TP1020 TP1030	WCE10	IC20N IC30N IC520N IC530N	PV3010 CT3000	TCM10
	P30	NS9530	VP45N NX3035 MP3025	T2500Z T3000Z		PV730	CZ25						IC530N	
M	M10	NS520	AP25N VP25N NX2525	T1000A	GC1525	TN620 TN610 PV720 PV710			KT315 KTP10	TP1030		IC20N IC30N IC520N IC530N	PV3010 CT3000	CTEP10 TCM10 TCM407
	M20	AT9530 GT9530 NS9530 J9530	AP25N VP25N NX2525	T1500A		TN620 PV720 PV730	CZ25					IC30N IC530N	PV3010 CT3000	
	M30	NS9530		T3000Z			CZ25							
K	K01	NS520	AP25N VP25N	T1000A		PV7005							PV3010	CTEP10 TCM10 TCM407
	K10	AT9530 GT9530 NS9530 J9530	AP25N VP25N NX2525		CT5015	TN60 CCX	CZ25		KT315 KTP10				PV3010 CT3000	TCM10
	K20	NS9530	AP25N VP25N NX2525				CZ25						PV3010 CT3000	

Note: The above table is selected from a publication. We have not obtained approval from each company.

●Cemented Carbide for Turning

Classification	ISO		Tungaloy	Mitsubishi Carbide	Sumitomo Electric	Sandvik	Kyocera	Moldino	NTK	Kennametal	Seco Tools	Walter	Iscar	TaeguTec	Ceratzit
	Symbol														
P	P01														
	P10	TH10		ST10P											S26T
	P20	KS20		ST20E									IC50M	P20	S26T S40T
	P30	KS15F UX30	UTi20T	A30									IC28 IC50M	P30	S40T
	P40		UTi20T										IC28		
M	M10	TH10		EH510						K313 KU10 K68	890		IC20		
	M20	KS20	UTi20T	EH520						K313 KU10 K68	HX 883		IC20		CTW7120 H210T U17T
	M30	UX30	UTi20T	A30									IC28		
	M40												IC28		S40T
K	K01	TH03	HTi05												CTWK601
	K10	TH10	HTi10	G10E	H13A	KW10	WH10			K313 KU10 K68	890		IC20	K10	H210T H10T U17T
	K20	KS15F KS20	UTi20T	G10E	H13A	KW10					890 HX 883		IC20	K20	CTW7120 H210T H10T U17T
	K30		UTi20T		H13A						883				TSM30
	K40														
N	N01	KS05F				H10	GW05						IC04		
	N10	TH10	HTi10	H1	H10	GW05 KW10	WH10	KM1		K313 KU10 K68	890 HX KX	WK1	IC20 IC28	K10	H210T H10T U17T
	N20	KS15F		H1	H13A			KM1			890 HX KX 883	WK1	IC20 IC28	K20	CTW7120 H210T H10T U17T
	N30										883				
S	S01		MT9005 RT9005		H10A	SW05							IC20		
	S10	KS05F TH10	MT9015 RT9010	EH510	H10F	SW10 KW10	WH10	KM1		K313 KU10 K68	890 883	WK1 WS10	IC20	K10	H210T H10T
	S20	KS15F KS20	MT9015 RT9010	EH520	H13A H10F	SW25		KM1			890 883	WK1 WS10	IC20 IC28	K20	CTW7120 H210T H10T
	S30										883				
H	H01												IC20		
	H10	TH10			H13A		WH10						IC20	K10	
	H20										890 HX 883				

Note: The above table is selected from a publication. We have not obtained approval from each company.

Technical Guide - Grade Comparison Chart

●CBN and PCD for Turning

ISO		Tungaloy	Mitsubishi Carbide	Sumitomo Electric	Sandvik	Kyocera	Moldino	Dijet	NTK	Seco Tools	Kennametal	Iscar	Ingersoll	TaeguTec	Widia	Walter	Ceratizit
Classification	Symbol																
K	K01	BX930 BX910 BX870	MB710 MB730 MB5015 MB5015	NCB100 BN500 BNC500	CB50	KBN475 KBN60M			B52		KB1630 KB1345	IB10K		TB7015	WBH10C	WCB80	CTB S10U
	K10	BX470 BX480	MB730 MB5015 MB4020	BN7000 BN500	CB7525 CB50	KBN65M KBN65B		JBN795	B23 B30 B52	CBN200 CBN300 CBN400C	KB1640 KB1345	IB05S IB10S	TB730	TB730	WBK40U	WCB80 WCB50	CTB S10U
	K20	BXC90 BX90S	MB4020 MB4120 MBS140	BNC8115 BNS8125	CB7925	KBN900 KBN70M			B23 B30 B52	CBN300 CBN500	KB5630	IB90A IB90 IB25KD		TB7020	WBK45U	WCB80	CTB S20C
	K30	BXC90 BX90S	MBS140 BC5030	BNS8125		KBN900			B16	CBN500	KB9640	IB90A IB25KD	KB90A	KB90A			
S	S01	BX815	MB730	NCB100 BN7000				JBN795	JP2	CBN170		IB05S IB10S		KB90			CTB S10U
	S10	BX480	MB4020 MB4120	BN7500 BN7115	CB7050	KBN65B KBN65M			B23 B30	CBN200	KB1630	IB05S IB10S		KB90A	WBK45U	WCB80	CTB S20C
H	H01	BXM10 BX310	BC8105 BC8110 MBC010 MB810 MB8110	BNC2010 BNC2115 BN1000 BN2000 BNX10 BN1000	CB7105	KBN510 KBN05M KBN10M			B52 B5K	CBN010 CBN100 CBN160C CBN050C	KB1610 KB5610*	IB05H IB10HC	TB610	TB610	WBH10C	WCB30	CTB H15C CTB H15U
	H10	BXA10 BXM10 BX330 BX530	BC8210 MB020 MB8025 MB8110 MB825	BNC2020 BNC2115 BN2000	CB7015 CB7115 CB7025	KBN525 KBN05M KBN10M		JBN245	B36 B52 B6K	CBN150 CBN200 CBN300 CBN060K CBN160C CBN400C	KB9610 KB1610 KB5610	IB50 IB55 IB10H IB10HC IB20H IB25HA		TB2015	WBH10C WBH10P WBH10U	WCB30 WCB50	CTB H15C CTB H15U
	H20	BXM20 BXA20 BX360	BC8220 MBC020 MB8025 MB8120	BNC200 BNC2020 BNC2125 BNX20	CB7015 CB7125 CB50	KBN525 KBN05M KBN10M KBN25M KBN020		JBN300	B22 B36 B40 B6K	CBN200 CBN300 CBN160C CBN400C CH2540	KB5625 KB1625	IB20H IB20HC IB25HA IB25HC	TB650 TB2030	TB650	WBH25P	WCB50 WCB80	CTB H20C CTB H21U
	H30	BR35F BXC50 BX380	BC8130 MB8130 MB835	BNC300 BN350 BNX25		KBN30M KBN35M KBN900		JBN300	B22 B40	CH3515	KB1630 KB9640	IB25HC IB90	TB670	TB670	WBH40C		CTB H40C CTB H40U
N	N01	DX160 DX180	MD205	DA90	CD05	KPD230		JDA30 JDA735	PD1		KD1405	ID5					CTD PU20
	N10	DX140	MD205 MD220	DA150	CD10	KPD010 KPD230		JDA715	PD1	PCD05 PCD10	KD100 KD1400 KD1425	ID5	IN90D	TD810	WDN25U	WCD10	CTD PU20
	N20	DX120	MD220 MD230	DA2200 DA1000	CD10	KPD010		JDA715	PD2	PCD05 PCD20	KD1425		IN90D	KP300	WDN25U	WCD10	CTD PD20
	N30	DX110	MD2030 MD230	DA2200 DA1000		PKD001		JDA10		OVD20 PCD30 PCD30M				TD830		WCD10	

Note: The above table is selected from a publication. We have not obtained approval from each company.

●Ceramic for Turning

ISO		Tungaloy	Mitsubishi Carbide	Sumitomo Electric	Sandvik	Kyocera	Moldino	Dijet	NTK	Seco Tools	Kennametal	Iscar	Ingersoll	TaeguTec	Widia	Walter	Ceratizit
Classification	Symbol																
K	K01	TZ120 LX21		NB90S	CC620	KA30 A65 KT66 PT600M			HC1 HW2		KY1310 KY1615	IN110		AW120 AB30	CW2015		CTN3105 CTS3105
	K10	CX710 FX105			CC6190 CC650	A65 KT66 A66N PT600M			HC2 HC5 HC6		KY1310 KY1615	IN23 IS6	IN70N	AB30 AS10	CW2015 CW5025	WSN10	CTN3105 CTM3110 CTI3105 CTN3110 CTS3105
	K20	FX105 CX710			CC6190	KS6000 KS6050			SP2 SP9 SX8 SX9		KY1320 KY3400 KY3500 KY4300	IS8	IN70N	SC10	CW5025	WSN10	CTM3110 CTN3110
S	S01	TS200							JX1	CS100	KY1525 KY2100	IS25		TC3020			
	S10	TW43 TS300 FX510		WX120	CC670 CC6060 CC6065	KS6030 KS6040			WA1 WA5 SX9	CW100 CS300	KY1540 KYS30 KY2100 KY4300	IW7 IS35		TC430 TC3030	CW3020	WWS20	
H	H01	LX10 LX11		NB100C	CC6050 CC650	PT600M			HC2 HC5 HC6		KY4300	IN420 IN22		AB2010	CW2015		CTS3105
	H10				CC6050 CC670 CC6190	A66N PT600M			HC7 WA1		KY4400	IN23		AB2010 AB20 AB30	CW2015		CTS3105

Note: The above table is selected from a publication. We have not obtained approval from each company.

Technical Guide - Chipbreaker Comparison Chart

● Negative insert type

ISO Classification	Cutting Mode	Tungaloy	Mitsubishi Carbide	Sumitomo Electric	Kyocera	Sandvik	Moldino	Kennametal	Seco Tools	Iscar	TaeguTec	Walter	Ceratizit	
P	Precision finishing	01 TF	PK FH	FA	GP	PF	FE	FS, LF	FF1	SF, PP, TF	FA			
	Finishing and light cutting	TS, TSF PS, ZF NS AS TQ	FP FY LP SH SA SY	SU FL SE, SX	XP, PP XQ, HQ, CJ, XS	PF LC MF R/L-K XF	BE, BH AB, CT CE	FF, FN	MF2	F3P NF, SF	FG VF, EA FC MC ML, MP	NF3 NS6	CF, TF	
	Finishing and light cutting (With Wiper)	AFW, FW ASW, SW	SW MW	LUW SEW GUW	WP WQ WF	WL, WF WMX WM, WR			FW MW RW	W-FF2 W-MF1 W-M3 W-M6	WF WG	WS WT	NF NM	TFQ TMQ
	Medium cutting	TM, AM PM, DM ZM, NM All-round, TA	MA MH, MP	GU GE, UX	HS, PT, GT CS, PS	PM, QM XM, XRM	AH AE, AY, B	MN	MF5 M3	M3P, M3M PP, TF, GN	PC, MT MC, MG	NMT, NM4	TMF, TMM M50	
	Medium to heavy cutting	TH THS	RP, GH	MU, ME HG	PH All-round	HM, PR MR	RE	RN, RP MR	M5 MR7	NR MR	RT	MM5, NM6 NM9	TM TRM	
Heavy cutting	TU TRS TUS	HM, HX HL, HR HZ, HV	HG, HP HU, HW HF	PX	PR, MR HR, QR	TE, UE HX, HE H	RM RH	R RR	R3P NM	HT, HD RX, RH HY, HZ	NR6 NRF NRR	TRR, TR R28, R58 R88		
M	Finishing and light cutting	SF SS	GM, LM	EX, EG SU, EF	GU MQ	MF, XF	MP BH, AB	FP, FF	FF1 MF1 MF3	TF, VL	EA, SF, SU FG	NF4 NMS	CF, F30, M34 F32, TF	
	Medium cutting	SM, SA S, TA SDM	MM, MA MS	GU HM	MU	MM, QM XM	PV, SE DE	MP, P	MF4 M3	M3M, PP	EM, ET	NM4	TMF, M42 M30, M52	
	Heavy cutting	SH, TH TU	GH, RM HL	EM, MU	MS TK	MR HM, PR	AH, AE	UP, RP	M5 MR3	MR, MH		NR4 NRT, NRS	TM, M60 TRM, TMR, TRR R80	
K	Finishing	CF	LK, MA	UZ	C	KF, XF	Y, AH	FN, MT		GN	FG		CF	
	Medium cutting	CM All-round	MK GK	GZ	ZS All-round	KM, QM XM, XMR	RE VA	RP, UN	M4 M5		MT MG	NM5	M50	
N	Heavy cutting	CH Flat-top	RK Flat-top	Flat-top	GC Flat-top	KR Flat-top	RE, V	MA Flat-top	MR9 Flat-top		RT	Flat-top	TMR, TR R28 R58, R88	
	Cutting of non-ferrous metals	P 28		AX	AH, A3	MF		MS GR		PP			F32	
S	Finishing	HRF	FJ, LS MJ	EF EX	SQ, SX	SF	VI	FS MS	MF1			NFT NF4		
	Medium cutting	HRM HMM SA, 28 SDM	MS RS, GJ	EG MU EM	SQ, SX	SMR	VI	UP RP	MF4 M1	PP	SM	NMS NM4, NRS, NR4	M34, M52	

Note: Above charts are based on published data and not authorized by each manufacturer.

● Positive insert type

ISO Classification	Cutting Mode	Tungaloy	Mitsubishi Carbide	Sumitomo Electric	Kyocera	Sandvik	Moldino	NTK	Kennametal	Seco Tools	Iscar	TaeguTec	Walter	Ceratzit		
P	Precision finishing	01	FV	FC	CF, CK		JQ		GM	FF1 F1	SF		PF2	F32		
	Finishing and light cutting	PSF, PF, SS PS, PSS TS, TSF	FP, FV, SV LP SVX	FP, LU FK, SC SU	GQ GP XP PP, VF WP	R/L-K PF UF	JQ JE		11, LF VF, FP FW, MW	MF2	PF SM, 14, 17 19, XL	FA FG	PF5 PF4 PS5	SF SMF		
		TSW, SW W08-20	SW, MW	LUW, SDW		WF, WK, WM					R/L RF, LF	GF	PF, PM	SMW, 25Q		
	Medium cutting	PM TM All-round RS	MP MV No sign	SU, MU SC	All-round HQ, XQ GK	PM UM, PR UR	JE		MP MF	M3 M5	DT, HQ	MT	PM5	SM		
High-feed, small depth of cut cutting	61									No sign 14	No sign					
M	Finishing	PSF, SS	FM, SV	FC		R/L-K UF, MF			11, VF	FF1 MF2		FG				
	Finishing to Medium cutting	PSS PS	LM SV	SI, GU LB, SU	MQ	MM UM			LF, FP	M3			PF4	SF, SMF		
	Medium cutting	PM	MM	MU	HQ	MR UR			MF, MP	M5			PM5	F23, F43 SM		
K	Cutting of cast irons	CM Flat-top	MK Flat-top	FC, MU Flat-top	KF KM UM, KR	Flat-top			11, VF, FP MP, MF Flat-top	M5 Flat-top	19	MT Flat-top	PS5, PM5 Flat-top	SF 25P 27, 29		
N	Cutting of non-ferrous metals	AL P Ground	AZ R/L-F R/L	AG AY AW LD, GD	AH	AL			HP, LF	AL	AS	FL	PF2 PM2	23P 25P 27, 29		
S	Finishing	PSF	FJ	FC	MQ	MF, UF, R/L-K			HP	F1				SF		
	Finishing to Medium cutting	PSS PS	LS, MS	SU, GU		MM SM			LF, FP	MF2				F23		
	Medium cutting	All-round		SI		UM, MR, UR						FG	PF2, PF4	SM, 25P, 29		
P M N S	Turning on small lathes	JP, 01 W08, W15, W20 J08	R/L-SR R/L-SN R/L-SS FS-P, F	W, SD FX, FY	CF, SKS R/L-F, R/L-FSF ER/L-U FR/L-U R/L-U FR/L-U, R/L-USF MF, R/F-FSF SK, GF CK, GQ	F, M UM	No sign	AMX AZ7 YL, AM3 U CL	LF		SM F2M	GF, GW SL SA SM SH	PM5			
		JS, JSS	LS-P	LU, FP, FK, SU FC, SI, SC												
		JRP, JSR, JPP J10, TS, JTS TSW SS	SW, MW SRF SMG													

Note: Above charts are based on published data and not authorized by each manufacturer.

MEMO

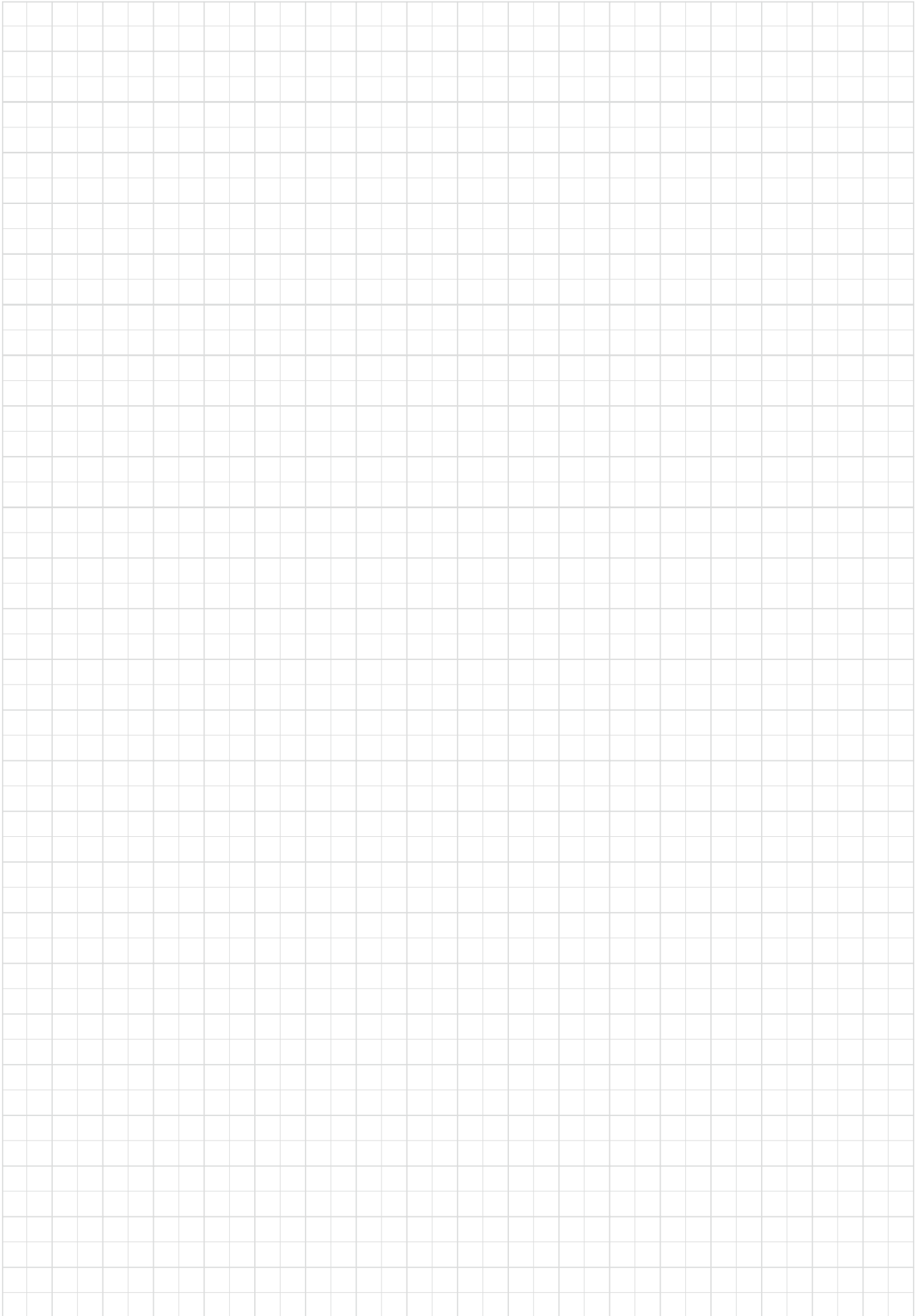

External Toolholder



External Toolholder - Content structure

- Indexable toolholders are listed by angle of cutting edge shape.
- Toolholders in the catalog are our standard items.

How to use the page

Method 1 Select the cutting edge shape described at the left end of each page, jump to the page on the left index, and choose a designation you need (4) in the dimension table (3). Applicable inserts are shown in (6) and (8).

Method 2 Select the cutting edge on **C003** and check the details on the product page.

Method 3 Select the series name of a toolholder on **C003** and check the details on each page.

Method 4 Select an item from Quick Guide on **C004 - C010**.

2 TURNING
C-ACLNR/L

Double-clamp toolholder, with 95° approach angle, for negative 80°/70° rhombic inserts (TurningA)

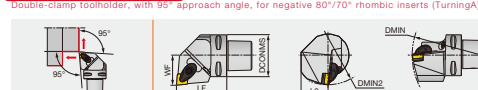

Cutting edge style L

Designation	DCONMS	LF	L2	WF	DMIN	DMIN2	RE	Insert	Torque*
CSACLNR/L22040-09040	32	40	20	22	110	121	0.8	CN**/GMG0904L	3
CSACLNR/L22040-12N	32	40	20	22	121	116	0.8	CN**/GMS04204L	3
CSACLNR/L27050-09040	40	50	25	27	140	110	0.8	CN**/GMG0904L	3
CSACLNR/L27050-12N	40	50	25	27	140	110	0.8	CN**/GMS04204L	3
CSACLNR/L33060-12N	50	60	32	35	165	110	0.8	CN**/GMS04204L	3
CSACLNR/L40065-0904N	63	65	35	45	190	110	0.8	CN**/GMG0904L	3
CSACLNR/L40065-12N	63	65	41	45	190	125	0.8	CN**/GMS04204L	3
CSACLNR/L41030-12N	63	135	41	45	190	110	0.8	CN**/GMS04204L	3
CSACLNR/L45065-16N	63	65	41	45	190	125	1.2	CN**/GMS04204L	6,4

Applicable for 7 MP coolant
*Torque: Recommended clamping torque (N·m)
**Applicable for 3 MP coolant; **Applicable for 7 MP coolant

4

C-A

Double-clamp toolholder, with 50° approach angle, for negative 80°/70° rhombic inserts

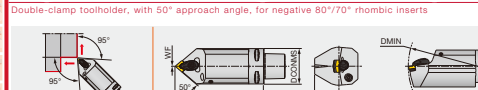

Cutting edge style L

Designation	DCONMS	LF	L2	WF	DMIN	RE	Insert	Torque*
CSACLNR/0095-12 ¹⁾	50	90	32	0	-	0.8	CN**/GMS04204L	3
CSACLNR/0095-12N ²⁾	50	90	32	0	165	0.8	CN**/GMS04204L	3
CSACLNR/105-12N ²⁾	50	125	32	0	165	0.8	CN**/GMS04204L	3
CSACLNR/125-12N ²⁾	50	125	32	0	165	0.8	CN**/GMS04204L	3
CSACLNR/190-12N ²⁾	63	190	37.5	0	190	0.8	CN**/GMS04204L	3
CSACLNR/201-60-12N ²⁾	63	140	37.5	0	190	0.8	CN**/GMS04204L	3

The items without DMIN cannot be used for boring.
*Torque: Recommended clamping torque (N·m)
1) Applicable for 3 MP coolant; 2) Applicable for 7 MP coolant

6

SPARE PARTS

Description	Clamp	Clamping screw	Coated parts	Shims	Shim screw	Spring	Spring pin	Wrench 1	Wrench 2
CSACLNR/0904N	ACP55-E	ACS-SW	SATZ-MK01-M3	ASC022	CSTB-3.5	BP-7	SP-2.5	-	T-15F
CACLNR/12N	ACP55	ACS-SW	SATZ-MK01-M3	ASC022	CSTB-3.5	BP-7	SP-2.5	-	T-15F
CSACLNR/40065-16N	ACP55	ACS-SW	SATZ-MK01-M3	ASC033	CSTB-5	BP-8	SP-2.5	KEY-V-T20	-
CSACLNR/0090-12	ACP48	ACS-SW	E283	ASC022	CSTB-3.5	BP-7	SP-2.5	-	T-15F
CSACLNR/0095-12	ACP48	ACS-SW	E283	ASC022	CSTB-3.5	BP-7	SP-2.5	-	T-15F

Reference pages: C-ACLNR/L, C-ACLNR: Inserts → B054 -, B075, CBN → B168 -, B178, PCD → B211 -
Parts for coolant hose → C115

C016 tungaloy.com

- 1: Cutting edge shape
- 2: Series name of indexable external toolholders
- 3: Dimension table
- 4: Toolholder designation
e.g. right-hand, 25x25 square shank

→ **ACLNR 2525 M0904-A**

5 TUNECAP
C-PCLNR/L

Lever-lock toolholder, with 95° approach angle, for negative 80°/70° rhombic inserts

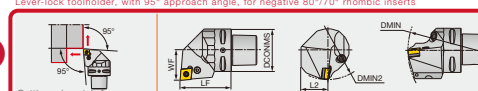

Cutting edge style L

Designation	DCONMS	LF	L2	WF	DMIN	DMIN2	RE	Insert
CSPCPLNR/L35060-12	50	60	32	35	165	110	0.8	CN**/GMS04204L
CSPCPLNR/L35060-12N	50	60	32	35	165	110	0.8	CN**/GMS04204L
CSPCPLNR/L45065-12N	63	65	41	45	190	125	0.8	CN**/GMS04204L

Applicable for 7 MP coolant
*Torque: without DMIN and DMIN2 cannot be used for boring

7

SPARE PARTS

Description	Coated parts	Lever	Clamping screw	Shim	Spring pin	Wrench
CSPCPLNR/L35060-12	E284	LCL4	LCS4	LSC42	LSF4	P-3
CPCPLNR/12N	SATZ-MK01-M5	LCL4	LCS4	LSC42	LSF4	P-3

8

DCLNR/L

"One-Double" toolholder with 95° approach angle, for negative 80°/70° rhombic inserts

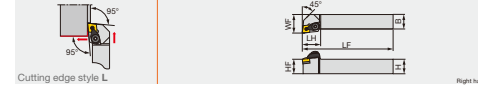

Cutting edge style L

Designation	H	B	LF	LH	HF	WF	RE*	Insert
DCLNR/L2030K12	20	20	125	30	30	25	0.8	CN**/GMS04204L
DCLNR/L2525M12	25	25	150	30	30	32	0.8	CN**/GMS04204L
DCLNR/L3225P12	32	25	170	30	32	32	0.8	CN**/GMS04204L

Note: Except for T16, T11, T15, S7, and 65-type chipbreaker inserts. *PE: Standard corner radius

9

SPARE PARTS

Description	Clamp	Clamping screw	Coated parts	Shims	Shim screw	Spring	Spring pin	Wrench 1	Wrench 2
DCLNR/L	DCPM-43	DLCL43	DPS43	DLCS43	LSC42	BP-10	LSF4	P-3	P-4

8

INSERT SELECTION

Application	Finishing	Medium cutting	Medium to heavy cutting	Application	Finishing	Medium cutting	Medium to heavy cutting
Chipbreaker shape	TF	T5F	TM	Chipbreaker shape	SF	SM	SH
Grades	T315	T315	T315	Grades	T315	AH025	AH025
Cutting conditions	B004	B004	B004	Cutting conditions	B006	B006	B006
Application	Grades	Finishing	Medium cutting	Application	Grades	Finishing	Medium cutting
Chipbreaker shape	K	KA10	KA10	Chipbreaker shape	N	NA10	NA10
Grades	T315	T315	T315	Grades	DX120	DX140	TH10
Cutting conditions	B008	B008	B010	Cutting conditions	B010	B010	B010
Application	Grades	Finishing	Medium cutting	Application	Grades	Finishing	Medium cutting
Chipbreaker shape	S	SA10	SA10	Chipbreaker shape	H	HA10	HA10
Grades	KA10	AH025	AH025	Grades	CB1	CB1	CB1
Cutting conditions	B012	B012	B014	Cutting conditions	B014	B014	B014

Reference pages: C-PCLNR/L: Inserts → B054 -, B075, CBN → B168 -, B178, PCD → B211 -
DCLNR/L: Inserts → B054 -, B075, CBN → B168 -, B178, PCD → B211 -
Parts for coolant hose → C115

Tungaloy C017

- 5: Dimension drawing (conforming to ISO13399)
- 6: Applicable insert
- 7: Spare parts
- 8: Basic selection
- 9: Reference pages

When ordering

- Please specify the designation and quantity.
e.g. **ACLNR2525M12-A ... 1** (one external toolholder per package)
- * Inserts are not included. Please order those separately.

C002 tungaloy.com

Main products

















L	95°		C015
J	93°		C032
V	72.5°		C050
I	76.5°		C053
A	91°		C054
G	91°		C057
X	20°		C065
E	60°		C069
N	63°		C070
D	45°		C074
S	45°		C080
K	75°		C084
F	91°		C087
Q	107.5°		C091
H	100°		C098
B	75°		C100
R	75°		C104
Special			C105

	ADDMULTURN Ultimate solution for multi-directional turning	C011
	TURNTEEN Innovative tool realizing both high productivity and economy	C013, C067
	ISOETURN Small-sized "Eco" insert series for maximized profits	C014
	MINIFORCE Economical double-sided inserts with excellent sharpness	C029, C045 C047, C113 -, C118
	TURNINGA Highly rigid clamping system with excellent repeatability	C004 -
	TUNGTURNJET Toolholders for high pressure coolant supply	C019 -, C026, C031 C037 -, C043 -, C059, C095
	DIMPLEFX Ceramic insert with dimple for highly efficient cast iron machining	C008
	TURNTEC Inserts and toolholders for roughing large depths of cut with high productivity	C054, C090, C103
	Y-PRO SERIES Inserts with 25° corner angle for profiling	C049, C053, C098 -
	TURNFEED Tool series for super high-feed cutting	C068
	FIXRTURN Highly productive round insert with 6 indexes	C064, C078











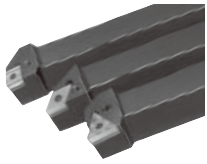









External Toolholder - Quick Guide (Square shanks)











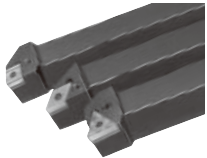









Brand name / Clamp system	Approach angle (Cutting edge style)	Designation	Inserts	Sizes of square shanks (mm)					Coolant supply		Page	
				20x20	25x25	32x25	32x32	40x40	External supply	TUNGALOY (Through-coolant)		
ADDTURN 	Front turning: 95° Back turning: 21.5° 	ATXOR/L	6C-TOMG** 	<input type="checkbox"/>	<input type="checkbox"/>		<input type="checkbox"/>		<input checked="" type="checkbox"/>	<input type="checkbox"/>	C065	
	Front turning: 117.5° Back turning: 27.5° 	ATXOR/L	6V-TOMG** 	<input type="checkbox"/>	<input type="checkbox"/>		<input type="checkbox"/>		<input checked="" type="checkbox"/>	<input type="checkbox"/>	C065	
	Front turning: 95° Back turning: 21.5° 	STXCR/L-CHP-MC	3C-TCMT** 			<input type="checkbox"/>				<input checked="" type="checkbox"/>	C066	
TURNFEED 	48.5° 	PPXOR/L**-HD	POMG** 				<input type="checkbox"/>		<input checked="" type="checkbox"/>	<input type="checkbox"/>	C067	
	22.5° 	PPXOR/L**-HF					<input type="checkbox"/>		<input checked="" type="checkbox"/>	<input type="checkbox"/>	C067	
Double clamp A TURNING 	L 95° 	ACLNR/L**12	CN**12 80° 	<input type="checkbox"/>	<input type="checkbox"/>	<input type="checkbox"/>			<input checked="" type="checkbox"/>	<input type="checkbox"/>	C015	
		ACLNR/L**12-CHP-MC	GNGA12 70° 							<input checked="" type="checkbox"/>	<input type="checkbox"/>	C019
		ACLNR/L**0904	CN**09 80° GNMG09 70° 	<input type="checkbox"/>	<input type="checkbox"/>					<input checked="" type="checkbox"/>	<input type="checkbox"/>	C015
	L 95° 	AWLNR/L**08	WN**08 80° 	<input type="checkbox"/>	<input type="checkbox"/>	<input type="checkbox"/>				<input checked="" type="checkbox"/>	<input type="checkbox"/>	C024
		AWLNR/L**08-CHP-MC								<input checked="" type="checkbox"/>	<input type="checkbox"/>	C027
		AWLNR/L**06	WN**06 80° 	<input type="checkbox"/>	<input type="checkbox"/>					<input checked="" type="checkbox"/>	<input type="checkbox"/>	C024
	J 93° 	ATJNR/L**16	TN**16 	<input type="checkbox"/>	<input type="checkbox"/>					<input checked="" type="checkbox"/>	<input type="checkbox"/>	C032
	G 91° 	ATGNR/L**16		<input type="checkbox"/>	<input type="checkbox"/>					<input checked="" type="checkbox"/>	<input type="checkbox"/>	C057
	F 91° 	ATFNR/L**16		<input type="checkbox"/>	<input type="checkbox"/>					<input checked="" type="checkbox"/>	<input type="checkbox"/>	C088
	Q 105° 	ATQNR/L**16		<input type="checkbox"/>	<input type="checkbox"/>					<input checked="" type="checkbox"/>	<input type="checkbox"/>	C091
	J 93° 	ADJNR/L**15	DN**15 55° FNGA15 45° 	<input type="checkbox"/>	<input type="checkbox"/>	<input type="checkbox"/>				<input checked="" type="checkbox"/>	<input type="checkbox"/>	C034
		ADJNR/L**15-CHP-MC								<input checked="" type="checkbox"/>	<input type="checkbox"/>	C038
ADJNR/L**1104		DN**11 55° FNMG11 45° 	<input type="checkbox"/>	<input type="checkbox"/>					<input checked="" type="checkbox"/>	<input type="checkbox"/>	C034	
P 62.5° * 	ADPNN**15	DN**15 55° FNGA15 45° 	<input type="checkbox"/>	<input type="checkbox"/>					<input checked="" type="checkbox"/>	<input type="checkbox"/>	C108	
Q 107.5° 	ADQNR/L**15	DN**15 55° FNGA15 45° 	<input type="checkbox"/>	<input type="checkbox"/>					<input checked="" type="checkbox"/>	<input type="checkbox"/>	C092	
	ADQNR/L**11	DN**11 55° FNMG11 45° 	<input type="checkbox"/>	<input type="checkbox"/>					<input checked="" type="checkbox"/>	<input type="checkbox"/>	C092	

*: Tungaloy's symbol

Brand name / Clamp system	Approach angle (Cutting edge style)	Designation	Inserts	Sizes of square shanks (mm)					Coolant supply		Page
				20x20	25x25	32x25	32x32	40x40	External supply	TUNGALLOY (Through-coolant)	
Double clamp A 	J 93°	AVJNR/L**16	VN**16 	○	○				✓		C041
	V 72.5°	AVVNN**16	YN**16 	○	○				✓		C050
	Q 117.5°	AVQNR/L**16		○	○				✓		C094
	J 93°	AVJNR/L**1204	VN**1204	○	○				✓		C041
	V 72.5°	AVVNN**1204		○	○				✓		C050
	Q 122.5°	AVQNR/L**1204		○	○				✓		C094
	B 75°	ASBNR/L12	SN**12	○	○				✓		C101
	D 45°	ASDNN12		○	○				✓		C074
	S 45°	ASSNR/L12		○	○				✓		C080
	K 75°	ASKNR/L12		○	○				✓		C084
		ARGNR/L	RN** 		○				✓		C060
One Double D 	L 95°	DCLNR/L12	CN**12  GNGA12 	○	○	○			✓		C017
	L 95°	DWLNR/L08	WN**08 	○	○	○			✓		C025
	J 93°	DDJNR/L15	DN**15 	○	○	○			✓		C035
	Q 105°	DDQNR/L15	FNGA15 	○	○	○			✓		C093
	G 91°	DTGNR/L16	TN**16 	○	○				✓		C058
	F 91°	DTFNR/L16		○	○				✓		C088
	B 75°	DSBNR/L12	SN**12	○	○				✓		C102
	D 45°	DSDNN12		○	○				✓		C074
	S 45°	DSSNR/L12		○	○				✓		C080
	K 75°	DSKNR/L12		○	○				✓		C084
		DRGNR/L12	RN** 		○				✓		C060

External Toolholder - Quick Guide (Square shanks)

Brand name / Clamp system	Approach angle (Cutting edge style)	Designation	Inserts	Sizes of square shanks (mm)					Coolant supply		Page	
				16x16	20x20	25x25	32x25	32x32	External supply	TUNGALOY (Through-coolant)		
	L 95° 	PCLNR/L**12 PCL2NR**12	CN**12  80°	○	○	○	○		✓		C018	
		PCLNR/L**12-CHP PCLNR/L**12-CHP-MC	GNGA12  70°		○	○					✓	C019, C020
		PCLNR/L**0904	CN**09  80°		○	○				✓		C018
		PCLNR/L**09-CHP-MC	GNMG09  70°		○						✓	C020
	B 75°	PCBNR/L**12	CN**12  80°			○			✓		C100	
	F 91°	PCFNR/L**12	CN**12  80°		○	○			✓		C087	
			GNGA12  70°									
	L 95°		PWLNR/L**08-CHP PWLNR/L**08-CHP-MC	WN**08  80°		○	○				✓	C026, C027
			PWLNR/L**0604	WN**06  80°		○	○			✓		C026
			PWLNR/L**0604-CHP			○	○				✓	C026
	L 95°	PTL2NR/L**16	TN**16  60°		○				✓		C030	
	J 93°	PTJNR/L**1104	TN**11  60°			○			✓		C032	
	G 91°		PTGNR/L**16	TN**16  60°	○	○	○			✓		C058
				PTGNR/L**16-CHP			○	○				✓
PTGNR/L**1104			TN**11  60°		○	○				✓		C058
			PTGNR/L**1104-CHP			○	○				✓	C059
F 91°		PTFNR/L**16	TN**16  60°	○	○	○			✓		C089	
		PTFNR/L**1104	TN**11  60°		○	○			✓		C089	

Brand name / Clamp system	Approach angle (Cutting edge style)	Designation	Inserts	Sizes of square shanks (mm)					Coolant supply		Page		
				16x16	20x20	25x25	32x25	32x32	External supply	TUNGALLOY (Through-coolant)			
Lever lock P 	J 93° 	PDJNR/L**15	DN**15 55° 		○	○	○			✓		C036	
		PDJNR/L**15-CHP	FNGA15 45° 		○	○					✓		C037
		PDJNR/L**1104	DN**11 55° 	○	○	○				✓			C036
		PDJNR/L**1104-CHP	FNMG11 45° 		○	○					✓		C037
	P 62.5° *	PDPNN**15	DN**15 55° 			○				✓			C108
	Q 107.5°	PDQNR/L15	FNGA15 45° 			○				✓			C093
	J 93° 	PVJNR/L**16-CHP	VN**16 35°  YN**16 25° 		○	○					✓		C043
		PVJNR/L**1204	VN**12 35° 	○	○	○				✓			C042
		PVJNR/L**1204-CHP			○	○					✓		C043
	Q 107.5° 	PVQNR/L**1204	VN**12 35° 		○	○				✓			C094
		PVQNR/L**16-CHP	VN**16 35°  YN**16 25° 		○	○					✓		C095
	V 72.5°	PVVNN**1204	VN**12 35° 		○	○				✓			C050
	B 75°	PSBNR/L12	SN**12		○	○				✓			C102
	D 45°	PSDNN12			○	○				✓			C075
	S 45°	PSSNR/L12		 90°		○	○	○		✓			C075
	K 75°	PSKNR/L12			○	○				✓			C085
		PRGNR/L	RN** 		○	○				✓			C060
		PRGCR/L	RCM**12 			○	○	○		✓			C062
PRDCN12					○	○			✓			C076	

*: Tungaloy's symbol

External Toolholder - Quick Guide (Square shanks)

Brand name / Clamp system	Approach angle (Cutting edge style)	Designation	Inserts	Sizes of square shanks (mm)							Coolant supply		Page	
				10x10	16x16	20x20	25x25	32x25	32x32	40x40	External supply	TUNGTALLOY (Through-coolant)		
Screw-on S 	L 95°	SCLCR/L	CC**12  80°		○	○					✓		C030	
	L 95°	JSWLXR/L JSWL2XR/L	WX**  80°	○	○	○	○				✓		C029	
	A 91°	STACR/L	TC**16  60°		○						✓		C054	
	J 93°		SDJCR/L11	DC**11  55°		○	○	○				✓		C046
			JSDJXR/L JSDJ2XR/L	DX**07  55°	○	○	○	○				✓		C045
	N 62.5°	SDNCN11	DC**11  55°		○	○	○					✓		C073
	Q 107.5°	SDQCR/L11				○	○				✓		C096	
	J 93°		SVJCR/L	VC**16  35°		○	○	○				✓		C048
			JSVJXR/L JSVJ2XR/L	VX**12  35°	○	○	○	○				✓		C047
	V 72.5°	SVVCN	VC**16  35°			○	○					✓		C052
	Q 117.5°	SVQCR/L				○	○				✓		C097	
	J 93°	SYJBR/L16	YWMT16  25°			○	○					✓		C049
	Q 122.5°	SYQBR/L16				○	○				✓		C098	
	H 100°	SYHBR/L16				○	○				✓		C099	
I 76.5°	SYIBN16				○	○				✓		C053		
		SRACR/L	RCM* 	○		○					✓		C056	
		SRGCR/L		○		○					✓		C063, C064	
		SRDCN				○	○				✓		C077, C078	
Double clamp for dimple ceramic insert C DIMPLEFX 	L 45°	CCLNR/L-RD	CN**  80°				○	○			✓		C022	
	J 93°	CDJNR/L-RD	DN**  55°				○	○			✓		C040	
	N 63°	CDNNN-RD					○				✓		C072	
	V72.5°	CVVNN-RD	VN**  35°				○				✓		C051	
	S 45°	CSSNR/L-RD	SNGD  90°				○				✓		C082	
	S 45°	CHSNR/L-RD	HNGD  90°				○				✓		C083	
	TURNTEC 	A 93°	TLANR/L16	LNMX16 			○	○		○	○	✓		C054
F 93°		TLFNR/L16	LNMX16 			○			○		✓		C090	

External Toolholder - Quick Guide



Brand name / Clamp system	Approach angle (Cutting edge style)	Designation	Inserts	Size						Coolant supply		Page
				C3	C4	C5	C6			Through-coolant	TUNGJET (Through-coolant)	
	E	C6STECN-Y-CHP	3C-TCMT** 				○			✓		C069
	N	C6SDNCN-Y-CHP	2D-DCMT** 				○			✓		C070
Double clamp A	L 95°	C*ACLNR/L12	CN**12 80° 	○	○	○	○			✓		C016
	L 95°	C*ACLNN12	GNGA12 70° 			○	○			✓		C016
	M	C6ACMNN0904	CN**09 80° 				○			✓		C105
	L 95°	C*ACLNR/L**0904	GNMG09 70° 	○	○		○			✓		C016
Lever lock P	L 95°	C*PCLNR/L12	CN**12 80° 			○	○			✓		C017
		C*PCLNR/L**12-CHP	GNGA12 70° 		○	○	○			✓		C019
	M	C6PCMNN**12-CHP	CN**09 80° 				○			✓		C106
	L 95°	C*PCLNR/L**0904-CHP	GNMG09 70° 		○		○			✓		C021
Double clamp A	L 95°	C*AWLNR/L08	WN**08 80° 		○		○			✓		C024
		C*AWLNR/L06	WN**06 80° 		○					✓		C024
Lever lock P	L 95°	C*PWLNR/L**08-CHP	WN**08 80° 		○		○			✓		C028
		C*PWLNR/L**06-CHP	WN**06 80° 		○					✓		C028

Grade
Insert
Ext. Toolholder
Int. Toolholder
Threading
Grooving
Miniature tool
Milling cutter
Endmill
Drilling tool
Tooling System
User's Guide
Index



Brand name / Clamp system	Approach angle (Cutting edge style)	Designation	Inserts	Size						Coolant supply		Page
				C3	C4	C5	C6			Through-coolant	TUNG T _{JET} (Through-coolant)	
Double clamp A	J 93°	C*ADJNR/L15	DN**15 		○	○	○			✓		C034
	N 62.5°	C*ADNNN15				○	○			✓		C071
	Q 107.5°	C*ADQNR/L15	FNGA15 		○	○				✓		C092
	U 93°	C*ADUNR/L			○					✓		C109
	J 93°	C*ADJNR/L1104	DN**11 FNMG11 		○	○		○		✓		C034
Lever lock P	J 93°	C*PDJNR/L15	DN**15 			○	○			✓		C038
		C*PDJNR/L**15-CHP	FNGA15 		○	○	○				✓	C039
		C*PDJNR/L**1104-CHP	DN**11 		○		○				✓	C039
	M	C6PDMNL1104-CHP	FNMG11 				○			✓		C107
Screw-on S	J 93°	C*SDJCR/L-CHP	DC**11 	○						✓		C046
Double clamp A	J 93°	C4ATJNR/L	TN**16 		○					✓		C032
Lever lock P	J 93°	C4PTJNR/L			○					✓		C033
Double clamp A	J 93°	C*AVJNR/L12	VN**12 		○		○			✓		C042
	Q 117.5°	C*AVQNR/L16	VN**16 YN**16 		○					✓		C094
Lever lock P	J 93°	C*PVJNR/L**-CHP	VN**16 YN**16 		○		○				✓	C044
		C*PVJNR/L**1204-CHP	VN**12 		○		○				✓	
Screw-on S	J 93°	C*SVJCR/L	VC**16 			○	○			✓		C048
	V 72.5°	C*SVVCN				○	○			✓		C052



Ultra high productivity of Front Turning, Back Turning, Profiling, and Face Turning with **ONE SINGLE TOOL**

Double-sided 6-corner insert with 80° or 35° corner angle for versatile applications

- **Back (pull) turning:** High feed designed cutting edge improves productivity about 200% higher than existing ISO tools with no need for special programming.
- **Front (push) turning:** Same machining process is available using the same cutting edge angle as standard ISO tools.

6C-TOMG

- Front turning
- Back turning

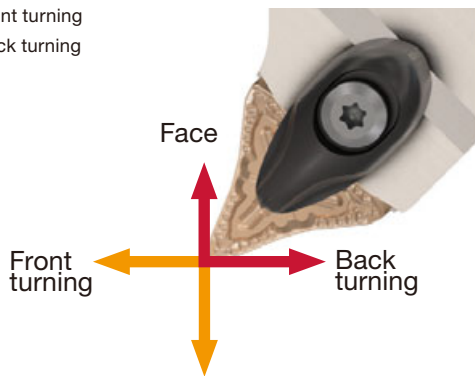

6V-TOMG

- Front turning
- Back turning

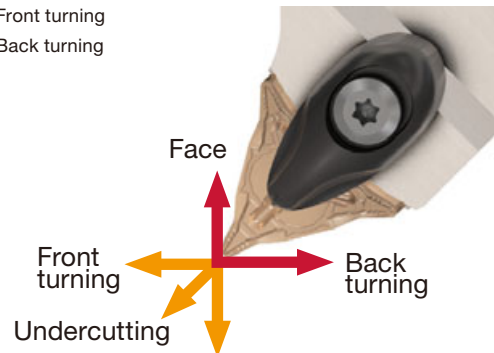

Single-sided 3-corner insert for super high productivity

- **Back (pull) turning:** High feed designed cutting edge improves productivity 300 - 400% higher than standard ISO tools.
- **Front (push) turning:** Applicable to great D.O.C.

3C-TCMT

- Front turning
- Back turning

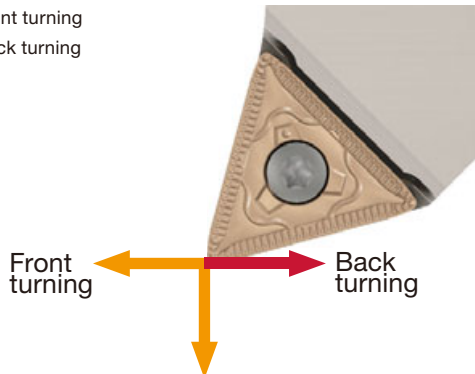

Internal coolant toolholder prevents chip jamming and maximizes performance during back turning operations

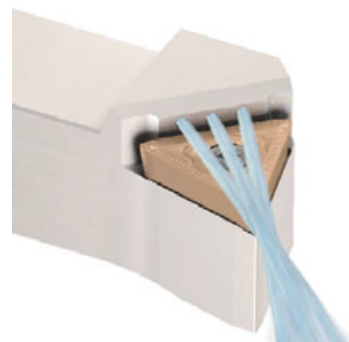

Reference pages: C065, C066, C116

LEADING IN THE NEW DIRECTION

Y-axis turning tool with PSC connection for multitasking machines



■ Y-axis machining benefits

- The cutting force vector is directed in the longitudinal axis of the tool, resulting in higher stability and minimized vibration
- No chip entanglements, chips are directed down and away from the workpiece and toolholder

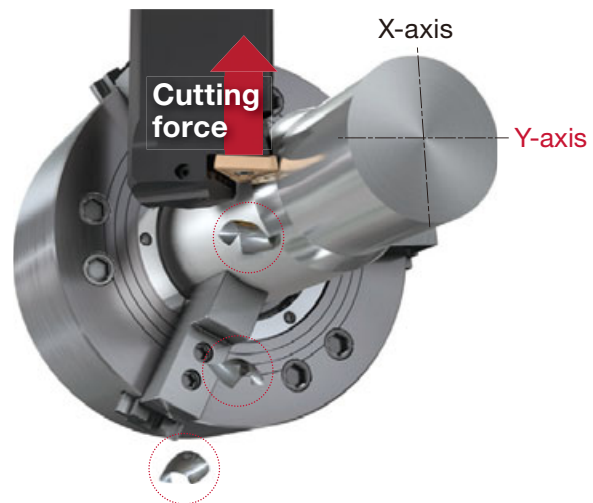

■ Tooling image of Y-axis orientation and applying high feed back turning

Medium cutting



3C-TCMT

Insert: 3C-TCMT29X608-TM
(Single-sided, 3 corners)

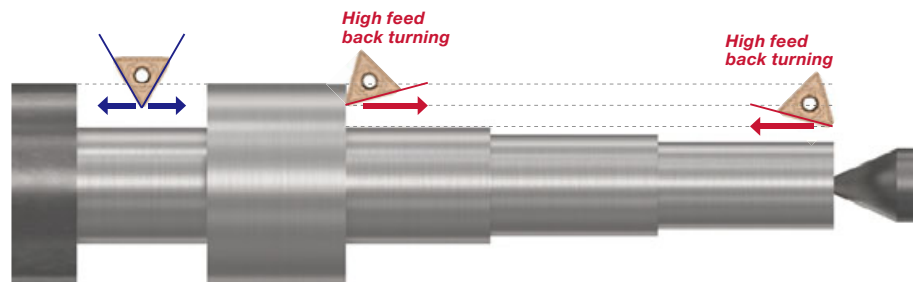

- Thanks to its high-feed geometry, **AddY-axisTurn** insert provides high productivity
- Y-axis tool orientation allows both sides of the cutting edge to be used, providing stable and long tool life

Finishing - Profiling



2D-DCMT

Insert: 2D-DCMT13T404-ZF
(Single-sided, 2 corners)

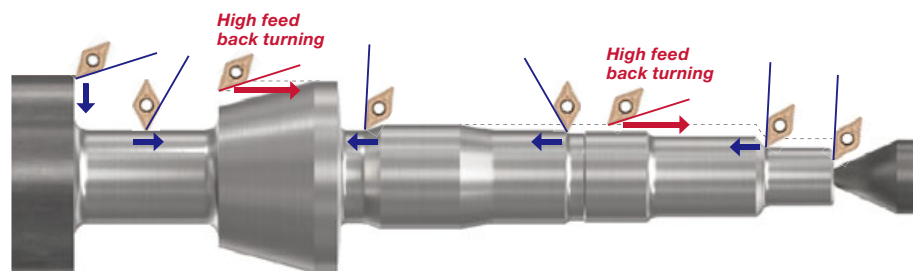

- **AddY-axisTurn** allows a precision workpiece completion with a single tool setup
- No interference with the tailstock
- Eliminates chip entanglement, promoting fully automated manufacturing

Reference pages: [C069](#), [C070](#), [C116](#)

TURN^{TEN}FEED



Economical, 10-cornered insert ensures high machining efficiency

- Available in 2 types of holders: HD type for large depths of cut and HF type for high feed turnin
- Maximum 7 mm depth of cut, or maximum 2.0 mm feed per rev is attainable!

Economical 10-cornered, double-sided, M-class insert

Achieves outstanding cost efficiency over standard ISO inserts.

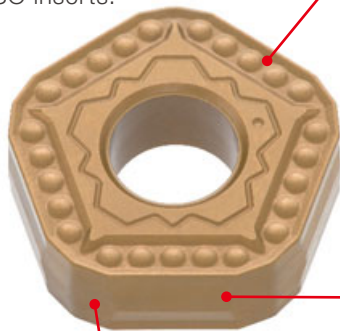

New – MNW style chipbreaker

Features protrusions on the rake face to facilitate smooth chip control, while achieving high crater wear resistance.

Dovetail clamping

Ensures secure insert retention while promoting smooth chip flow thanks to the integration of lever lock and dovetail clamping methods.

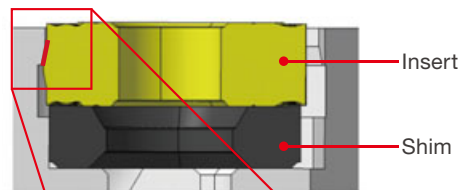

Insert

Shim

Flat Wiper

Built in the cutting edge to achieve superior machining surface at higher feed rates!



Insert / clamp contact cross section

Holder selections

Available in 2 types:

- HD holder for large depths of cut
 - HF holder for high feed turning
- Inserts are interchangeable between these two holders.

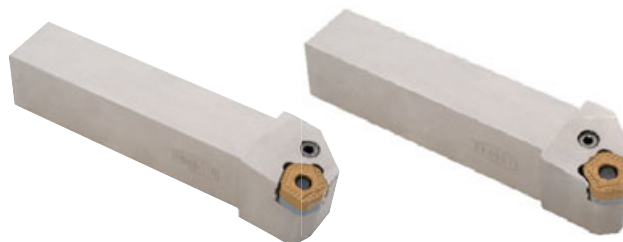

Features of Holders

HD holder
For High Depth of Cut

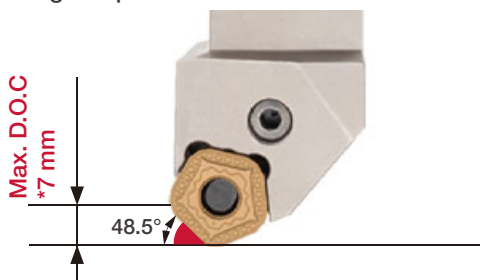

HF holder
For High Feed

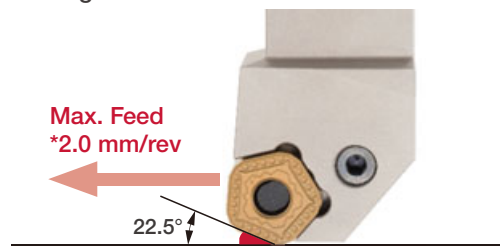

*Insert: POMG130612-MNW

Reference pages: C067, C117

Grade
Insert
Ext. Toolholder
Int. Toolholder
Threading
Grooving
Miniature tool
Milling cutter
Endmill
Drilling tool
Tooling System
User's Guide
Index





ISO-EcoTurn Small size inserts, for an economical advantage

■ Uncompromising insert performance

Comparison of ISO-EcoTurn and regular size inserts

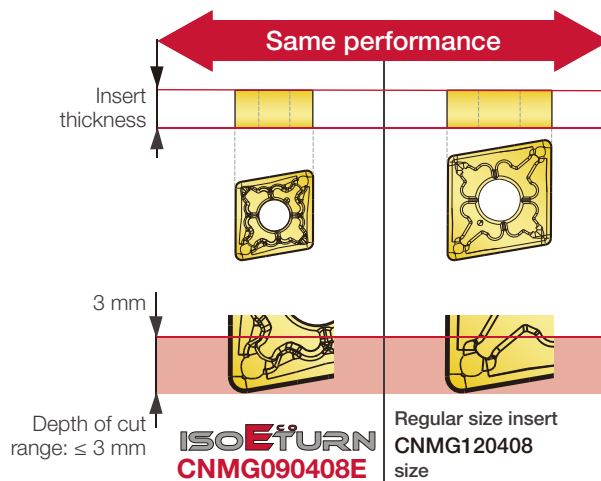

ISO-EcoTurn inserts feature the identical thickness and chipbreaker geometry as Tungaloy's regular size inserts. These properties provide cutting performance equal to that of the regular size inserts, including chip control at a depth of cut up to 3 mm.

■ Chip control

ISO-EcoTurn inserts incorporate an identical chipbreaker geometry as regular size inserts providing the same chip removal at a depth of cut up to 3 mm.

ISO^{Eco}TURN
CNMG090408E-TM

Regular size
CNMG120408-TM

Depth of cut (mm)	3.0					
	2.0					
	1.5					
	1.0					
	0.5					
	condition	0.10	0.15	0.20	0.30	0.40
Feed (mm/rev)						

Depth of cut (mm)	3.0					
	2.0					
	1.5					
	1.0					
	0.5					
	condition	0.10	0.15	0.20	0.30	0.40
Feed (mm/rev)						

Workpiece : S45C
Cutting speed : $V_c = 200$ m/min
Coolant : Wet

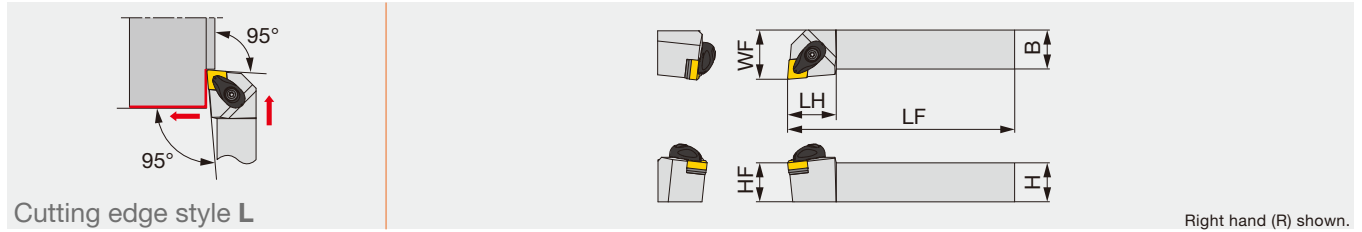

Right hand (R) shown.

Designation	H	B	LF	LH	HF	WF	RE**	Insert	Torque*
ACLNR/L2020K0904-A	20	20	125	25	20	25	0.8	CN**/GNMG0904...	3
ACLNR/L2020H12-A	20	20	100	26	20	25	0.8	CN**/GNGA1204...	3
ACLNR/L2020K12-A	20	20	125	26	20	25	0.8	CN**/GNGA1204...	3
ACLNR/L2525M0904-A	25	25	150	25	25	32	0.8	CN**/GNMG0904...	3
ACLNR/L2525K12-A	25	25	125	30	25	32	0.8	CN**/GNGA1204...	3
ACLNR/L2525M12-A	25	25	150	30	25	32	0.8	CN**/GNGA1204...	3
ACLNR/L2525M16-A	25	25	150	31	25	32	1.2	CN**1606...	6.4
ACLNR/L3225P12-A	32	25	170	30	32	32	0.8	CN**/GNGA1204...	3
ACLNR/L3225P16-A	32	25	170	31	32	32	1.2	CN**1606...	6.4
ACLNR/L3232P16-A	32	32	170	31	32	40	1.2	CN**1606...	6.4
ACLNR/L3232P19-A	32	32	170	40	32	40	1.2	CN**1906...	6.4
ACLNR/L4040S19-A	40	40	250	40	40	50	1.2	CN**1906...	6.4

*Torque: Recommended clamping torque (N·m)

**RE: Standard corner radius

SPARE PARTS

Designation	Clamp	Clamp screw	Spring	Spring pin	Shim	Shim screw	Wrench1	Wrench2
ACLNR/L**0904-A	ACP3S-E	ACS-5W	BP-7	SP-2.5	ASC322	CSTB-3.5	T-15F	-
ACLNR/L**12-A	ACP4S	ACS-5W	BP-7	SP-2.5	ASC422	CSTB-3.5	T-15F	-
ACLNR/L**16-A	ACP5S	ACS-6W	BP-8.8	SP-2.5	ASC533	CSTB-5	-	KEYV-T20
ACLNR/L**19-A	ACP6S	ACS-6W	BP-8.8	SP-2.5	ASC634	CSTB-5	-	KEYV-T20

INSERT SELECTION

P	Application	Precision finishing	Finishing	Medium cutting	Medium to heavy cutting
	Grade	NS9530	GT9530	T9215	T9215
	Chipbreaker shape	TF	TSF	TM	TH
	Cutting conditions	B004			
M	Application	Finishing	Medium cutting	Medium to heavy cutting	
	Grade	T6215	AH6225	AH6225	
	Chipbreaker shape	SF	SM	SH	
	Cutting conditions	B006			
K	Application	Finishing	Medium cutting	Medium to heavy cutting	
	Grade	T515	T515	T515	
	Chipbreaker shape	All-round	All-round	All-round	
	Cutting conditions	B008			
N	Application	Precision finishing	Finishing	Medium cutting	
	Grade	DX120	DX140	TH10	
	Chipbreaker shape	DIA	with rake DIA	P	
	Cutting conditions	B010			
S	Application	Precision finishing	Finishing	Medium cutting	
	Grade	BX470	AH8005	AH8005	
	Chipbreaker shape	CBN	HRF	HRM	
	Cutting conditions	B012			
H	Application	Precision finishing	Finishing		
	Grade	BXA10	BXA20		
	Chipbreaker shape	CBN	CBN		
	Cutting conditions	B014			

Reference pages: ACLNR/L: Inserts → B054 -, B075, CBN → B168 -, B178, PCD → B211 -



TURNINGA

C-ACLNR/L

Double-clamp toolholder, with 95° approach angle, for negative 80°/70° rhombic inserts (TurningA)

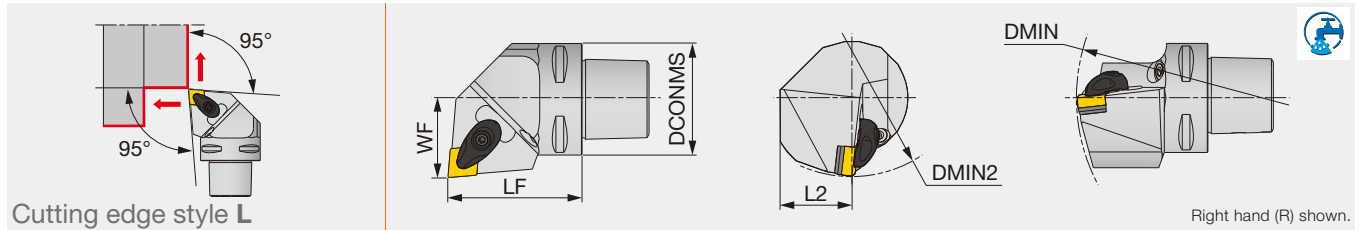

Designation	DCONMS	LF	L2	WF	DMIN	DMIN2	RE	Insert	Torque*
C3ACLNR/L22040-0904N	32	40	20	22	110	121	0.8	CN**/GNMG0904...	3
C3ACLNR/L22040-12N	32	40	20	22	121	116	0.8	CN**/GNGA1204...	3
C4ACLNR/L27050-0904N	40	50	25	27	140	110	0.8	CN**/GNMG0904...	3
C4ACLNR/L27050-12N	40	50	25	27	140	110	0.8	CN**/GNGA1204...	3
C5ACLNR/L35060-12N	50	60	32	35	165	110	0.8	CN**/GNGA1204...	3
C6ACLNR/L45065-0904N	63	65	35	45	190	110	0.8	CN**/GNMG0904...	3
C6ACLNR/L45065-12N	63	65	41	45	190	125	0.8	CN**/GNGA1204...	3
C6ACLNR/L45135-12N	63	135	41	45	190	110	0.8	CN**/GNGA1204...	3
C6ACLNR/L45065-16N	63	65	41	45	190	125	1.2	CN**1606...	6.4

Applicable for 7 MPa coolant
*Torque: Recommended clamping torque (N·m)

C-ACLNN

Double-clamp toolholder, with 50° approach angle, for negative 80°/70° rhombic inserts

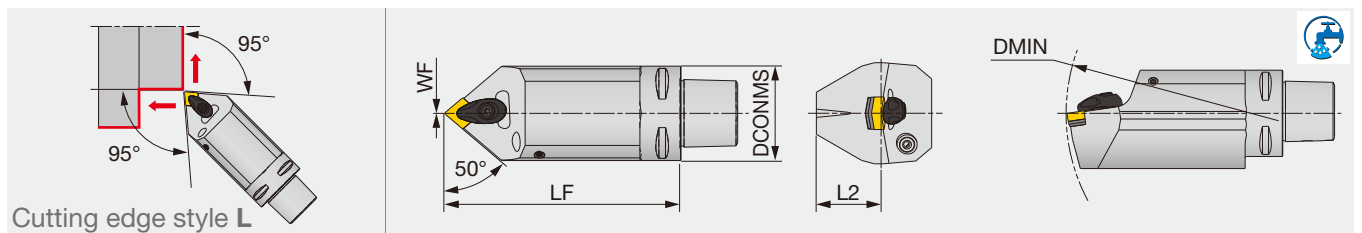

Designation	DCONMS	LF	L2	WF	DMIN	RE	Insert	Torque*
C5ACLNN00090-12 ⁽¹⁾	50	90	32	0	-	0.8	CN**/GNGA1204...	3
C5ACLNN00090-12N ⁽²⁾	50	90	32	0	165	0.8	CN**/GNGA1204...	3
C5ACLNN00125-12 ⁽¹⁾	50	125	32	0	-	0.8	CN**/GNGA1204...	3
C5ACLNN00125-12N ⁽²⁾	50	125	32	0	165	0.8	CN**/GNGA1204...	3
C6ACLNN00100-12N ⁽²⁾	63	100	37.5	0	190	0.8	CN**/GNGA1204...	3
C6ACLNN00140-12N ⁽²⁾	63	140	37.5	0	190	0.8	CN**/GNGA1204...	3

The items without DMIN cannot be used for boring.
*Torque: Recommended clamping torque (N·m)
(1) Applicable for 3 MPa coolant (2) Applicable for 7 MPa coolant

SPARE PARTS

Designation	Clamp	Clamping screw	Coolant parts	Shim	Shim screw	Spring	Spring pin	Wrench 1	Wrench 2
C*ACLNN***-0904N	ACP3S-E	ACS-5W	SATZ-M10X1-5	ASC322	CSTB-3.5	BP-7	SP-2.5	-	T-15F
C*ACLNN***-12N	ACP4S	ACS-5W	SATZ-M8X1-M3	ASC422	CSTB-3.5	BP-7	SP-2.5	-	T-15F
C6ACLNN*45065-16N	ACP5S	ACS-6W	SATZ-M8X1-M3	ASC533	CSTB-5	BP-8.8	SP-2.5	KEYV-T20	-
C5ACLNN00090-12	ACP4S	ACS-5W	EZ83	ASC422	CSTB-3.5	BP-7	SP-2.5	-	T-15F
C5ACLNN00125-12	ACP4S	ACS-5W	EZ83	ASC422	CSTB-3.5	BP-7	SP-2.5	-	T-15F

Reference pages: C-ACLNR/L, C-ACLNN: Inserts → **B054 - , B075**, CBN → **B168 - , B178**, PCD → **B211 -**
Parts for coolant hose → **C115**

Lever-lock toolholder, with 95° approach angle, for negative 80°/70° rhombic inserts

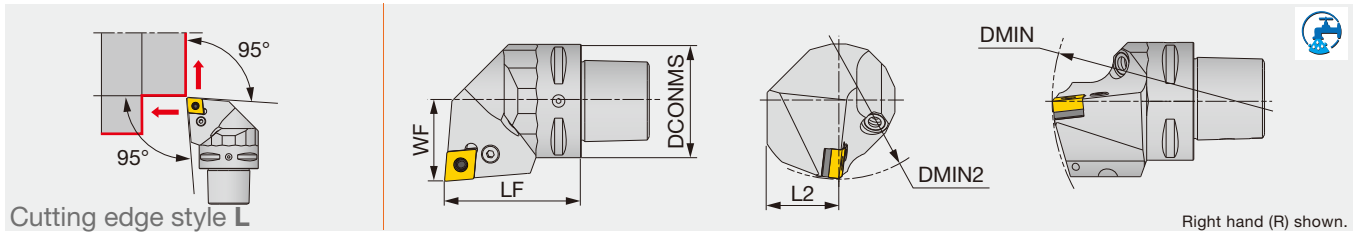

Designation	DCONMS	LF	L2	WF	DMIN	DMIN2	RE	Insert
C5PCLNR/L35060-12	50	60	32	35	-	-	0.8	CN**/GNGA1204...
C5PCLNR/L35060-12N	50	60	32	35	165	110	0.8	CN**/GNGA1204...
C6PCLNR/L45065-12N	63	65	41	45	190	125	0.8	CN**/GNGA1204...

Applicable for 7 MPa coolant
The item without DMIN and DMIN2 cannot be used for boring.

Designation	Coolant parts	Lever	Clamping screw	Shim	Spring pin	Wrench
C5PCLNR/L35060-12	EZ104	LCL4	LCS4	LSC42	LSP4	P-3
C*PCLN***-12N	SATZ-M10X1-M5	LCL4	LCS4	LSC42	LSP4	P-3

DCLNR/L

"One-Double" toolholder with 95° approach angle, for negative 80°/70° rhombic inserts

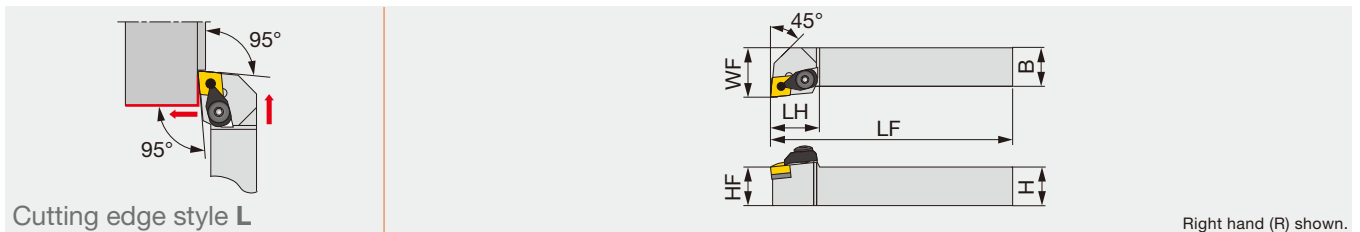

Designation	H	B	LF	LH	HF	WF	RE**	Insert
DCLNR/L2020K12	20	20	125	30	20	25	0.8	CN**/GNGA1204...
DCLNR/L2525M12	25	25	150	30	25	32	0.8	CN**/GNGA1204...
DCLNR/L3225P12	32	25	170	30	32	32	0.8	CN**/GNGA1204...

Note: Except for TRS, TU, TUS, 57, and 65-type chipbreaker inserts **RE: Standard corner radius

Designation	Clamp	Lever	Piston	Clamp screw	Shim	Spring	Spring pin	Wrench1	Wrench2
DCLNR/L...	DCPM-43	DLCL43	DPIS43	DLCS43	LSC42	BP-10	LSP4	P-3	P-4

INSERT SELECTION

Application	Precision finishing	Finishing	Medium cutting	Medium to heavy cutting
	Grade	NS9530	GT9530	T9215
Chipbreaker shape	TF	TSF	TM	TH
Cutting conditions	B004			

Application	Finishing	Medium cutting	Medium to heavy cutting
	Grade	T6215	AH6225
Chipbreaker shape	SF	SM	SH
Cutting conditions	B006		

Application	Finishing	Medium cutting	Medium to heavy cutting
	Grade	T515	T515
Chipbreaker shape	All-round	All-round	All-round
Cutting conditions	B008		

Application	Precision finishing	Finishing	Medium cutting
	Grade	DX120	DX140
Chipbreaker shape	DIA	DIA with rake	P
Cutting conditions	B010		

Application	Precision finishing	Finishing	Medium cutting
	Grade	BX470	AH8005
Chipbreaker shape	CBN	HRF	HRM
Cutting conditions	B012		

Application	Precision finishing	Finishing
	Grade	BXA10
Chipbreaker shape	CBN	CBN
Cutting conditions	B014	

Reference pages: C-PCLNR/L: Inserts → B054 -, B075, CBN → B168 -, B178, PCD → B211 -
DCLNR/L: Inserts → B054 -, B075, CBN → B168 -, B178, PCD → B211 -,
Parts for coolant hose → C115



PCLNR/L

Lever-lock toolholder with 95° approach angle, for negative 80°/70° rhombic inserts

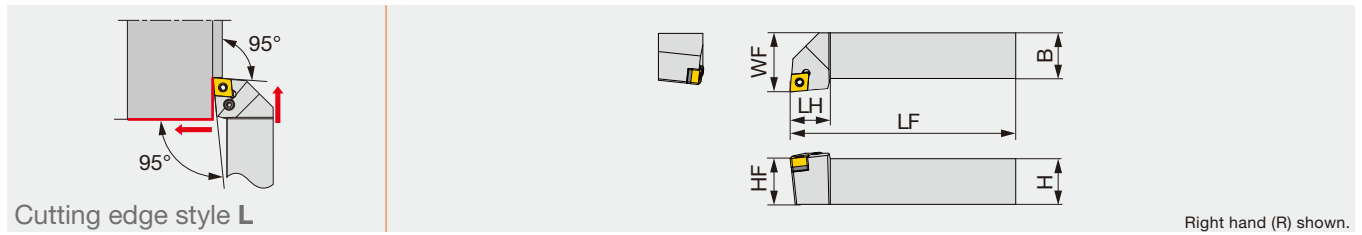

Right hand (R) shown.

Designation	H	B	LF	LH	HF	WF	RE**	Insert	Torque*
PCLNR/L1616H09	16	16	100	20	16	20	0.8	CN**0903...	2
PCLNR/L1616	16	16	100	26	16	20	0.8	CN**/GNGA1204...	3
PCLNR/L1616H12E	16	16	100	26	16	20	0.8	CN**/GNGA1204...	3
PCLNR/L2020K09	20	20	125	20	20	25	0.8	CN**0903...	2
PCLNR/L2020K0904	20	20	125	20	20	25	0.8	CN**/GNMG0904...	2
PCLNR/L2020	20	20	125	28	20	25	0.8	CN**/GNGA1204...	3
PCLNR/L2020K12E	20	20	125	28	20	25	0.8	CN**/GNGA1204...	3
PCLNR/L2525M09	25	25	150	20	25	32	0.8	CN**0903...	2
PCLNR/L2525M0904	25	25	150	25	25	32	0.8	CN**/GNMG0904...	2
PCLNR/L2525M4	25	25	150	28	25	32	0.8	CN**/GNGA1204...	3
PCLNR/L2525M12E	25	25	150	28	25	32	0.8	CN**/GNGA1204...	3
PCLNR/L2525M16E	25	25	150	31	25	25	1.2	CN**1606...	3
PCLNR/L3225P4	32	25	170	28	32	32	0.8	CN**/GNGA1204...	3
PCLNR/L3232	32	32	170	40	32	40	1.2	CN**1906...	5
PCLNR/L3225P12E	32	25	170	28	32	32	0.8	CN**/GNGA1204...	3
PCLNR/L3225P16E	32	25	150	31	32	32	1.2	CN**1606...	3
PCLNR3232P16E	32	32	170	31	32	40	1.2	CN**1606...	3
PCLNR/L3232P19E	32	32	170	40	32	40	1.2	CN**1906...	5

*Torque: Recommended clamping torque (N·m)
**RE: Standard corner radius

SPARE PARTS

Designation	Shim	Clamping screw	Wrench	Spring pin	Lever
PCLNR/L**09	ELSC32	LCS3	P-2.5	LSP3L	LCL33
PCLNR/L1616	LSC42	LCS4CA	P-3	LSP4	LCL4
PCLNR/L1616H12E	ELSC42	LCS4CA	P-3	LSP4S	LCL43S
PCLNR/L**0904	LSC317	LCS3	P-2.5	LSP3	LCL33
PCLNR/L2020	LSC42	LCS4	P-3	LSP4	LCL4
PCLNR/L2020K12E, **2525M12E, **3225P12E	ELSC42	LCS4	P-3	LSP4S	LCL43M
PCLNR/L2525M4, **3225P4	LSC42	LCS4	P-3	LSP4	LCL4
PCLNR/L**16E	ELSC53	LCS5	P-3	LSP6C	LCL54
PCLNR/L3232	LSC63	LCS6	P-4	LSP6	LCL6
PCLNR/L3232P19E	ELSC63	LCS6	P-4	LSP6	LCL6

INSERT SELECTION

P	Application	Precision finishing	Finishing	Medium cutting	Medium to heavy cutting
	Grade	NS9530	GT9530	T9215	T9215
	Chipbreaker shape	TF	TSF	TM	TH
	Cutting conditions	B004			
M	Application	Finishing	Medium cutting	Medium to heavy cutting	
	Grade	T6215	AH6225	AH6225	
	Chipbreaker shape	SF	SM	SH	
	Cutting conditions	B006			
K	Application	Finishing	Medium cutting	Medium to heavy cutting	
	Grade	T515	T515	T515	
	Chipbreaker shape	All-round	All-round	All-round	
	Cutting conditions	B008			
N	Application	Precision finishing	Finishing	Medium cutting	
	Grade	DX120	DX140	TH10	
	Chipbreaker shape	DIA	with rake DIA	P	
	Cutting conditions	B010			
S	Application	Precision finishing	Finishing	Medium cutting	
	Grade	BX470	AH8005	AH8005	
	Chipbreaker shape	CBN	HRF	HRM	
	Cutting conditions	B012			
H	Application	Precision finishing	Finishing		
	Grade	BXA10	BXA20		
	Chipbreaker shape	CBN	CBN		
	Cutting conditions	B014			

Reference pages: PCLNR/L: Inserts → **B054 - , B075**, CBN → **B168 - , B178**, PCD → **B211 -**

PCLNR/L-CHP

Tube connection

Lever lock toolholders – 95° approach angle.
For negative 80°/70° rhombic insert. High-pressure coolant capability.

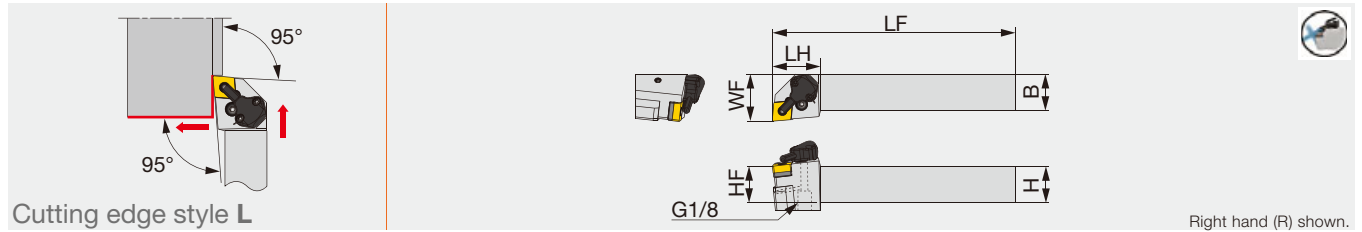

Designation	H	B	LF	LH	HF	WF	RE**	Insert	Torque*
PCLNR/L2020K0904-CHP	20	20	125	33	20	32	0.8	CN**/GNMG0904...	2
PCLNR/L2020K12-CHP	20	20	125	33	20	32	0.8	CN**/GNGA1204...	3
PCLNR/L2525M0904-CHP	25	25	150	33	25	32	0.8	CN**/GNMG0904...	2
PCLNR/L2525M12-CHP	25	25	150	33	25	32	0.8	CN**/GNGA1204...	3

*Torque: Recommended torque (N-m) for clamping

**RE: Standard corner radius

SPARE PARTS

Designation	Shim	Clamping screw	Wrench 1	Spring pin	Lever
PCLNR/L**0904-CHP	LSC317	LCS3	P-2.5	LSP3	LCL33
PCLNR/L**12-CHP	LSC42	LCS4	P-3	LSP4	LCL4

SPARE PARTS

Designation	Coolant unit	Mounting screw	Wrench 2	O-ring	Coolant screw	Wrench 3
PCLNR/L**0904-CHP	CU-CW-CHP	SRM3	T-8F	OR6.4X0.9N	SRM4X4TL360	P-2
PCLNR/L**12-CHP	CU-CW-CHP	SRM3	T-8F	OR6.4X0.9N	SRM4X4TL360	P-2

ACLNR/L-CHP-MC

Direct connection

Tube connection

Double clamping tool holders-95° approach angle
For negative 80°/70° rhombic insert. High-pressure coolant capability with tube and direct connections

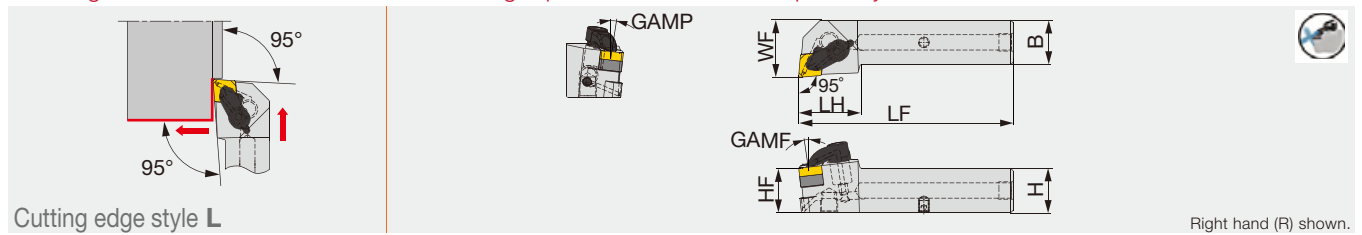

Designation	H	B	LF	LH	HF	WF	GAMP	GAMF	Insert	Torque*
ACLNR/L2020X-12-CHP-MC	20	20	105	35	20	25	6°	6°	CN**/GNGA1204...	4
ACLNR/L2525X-12-CHP-MC	25	25	120	35	25	32	6°	6°	CN**/GNGA1204...	4

*Torque: Recommended torque (N-m) for clamping

Applicable for 14 MPa pressure coolant

SPARE PARTS

Designation	Clamp set	Shim	Shim screw	screw for tube connection	Coolant plug	O-ring	Wrench 1
ACLNL**X-12-CHP-MC	LCGL-4JCSET	RCT443	SR14-506	PLUGG1/8-6.5TL360	SRM5X5 DIN913TL360	OR4X3NBR70	KEYV-T20
ACLNR**X-12-CHP-MC	LCGR-4JCSET	RCT443	SR14-506	PLUGG1/8-6.5TL360	SRM5X5 DIN913TL360	OR4X3NBR70	KEYV-T20

Reference pages: PCLNR/L-CHP, ACLNR/L-CHP-MC:

Inserts → **B054 - , B075**, CBN → **B168 - , B178**, PCD → **B211 -**, Parts for coolant hose → **C115**

PCLNR/L2020X-CHP-MC

Direct connection

Lever lock toolholders – 95° approach angle.

For negative 80°/70° rhombic insert. High-pressure coolant capability with bottom direct connection

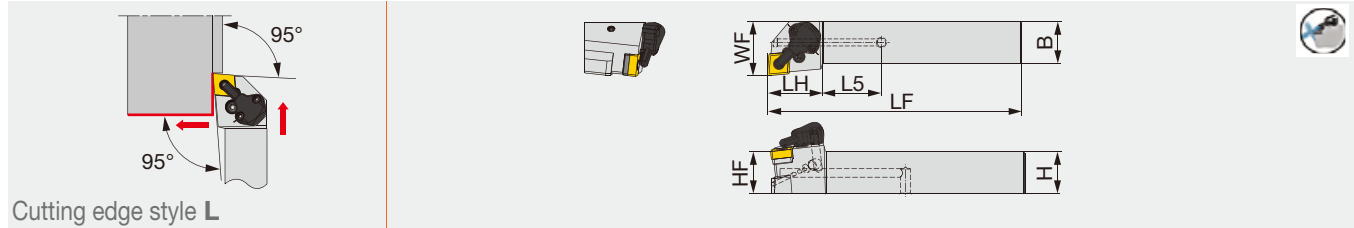

Cutting edge style L

Designation	H	B	LF	LH	HF	L5	WF	Insert	Torque*
PCLNR/L2020X09-CHP-MC	20	20	97	27	20	29	25	CN**/GNMG0904...	2
PCLNR/L2020X12-CHP-MC	20	20	97	27	25	29	25	CN**/GNGA1204...	3

*Torque: Recommended torque (N-m) for clamping

SPARE PARTS

Designation	Shim	Spring	Lever	Spring	Spring pin	Wrench	Coolant unit	Wrench	Coolant plug	Wrench
PCLNR/L2020X09-CHP-MC	TCN323	SP3	LR3	SR117-2014	PN3-4	HW2.5	CU-CW-CHP	T-8/5	SRM5X5 DIN913TL360	-
PCLNR/L2020X12-CHP-MC	TCN443	SP4	LR4DH	SR117-2010	PN3-4L	HW2.5	CU-CW-CHP	T-8/5	SRM5X5 DIN913TL360	HW3.0

ISO TURN PCLNR/L-CHP-N

Tube connection

Lever-lock toolholder with 95° approach angle, for negative 80°/70° rhombic inserts

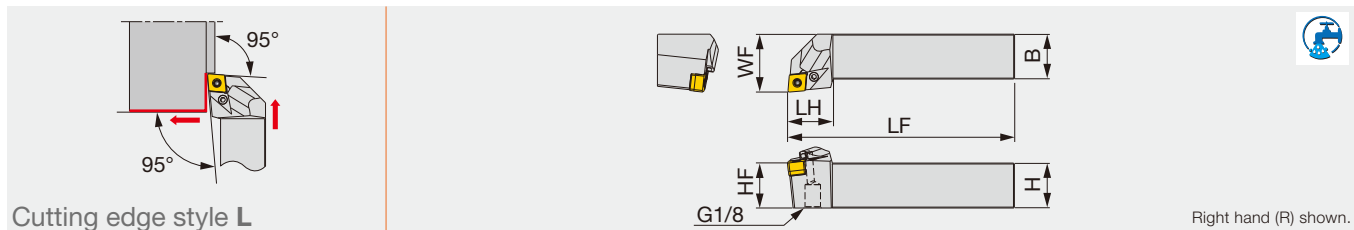

Cutting edge style L

Right hand (R) shown.

Designation	H	B	LF	LH	HF	WF	RE**	Air hole	Insert	Torque*
PCLNR/L2020H0904-CHP-N	20	20	100	25	20	25	0.8	With	CN**/GNMG0904...	2
PCLNR/L2525K0904-CHP-N	25	25	125	25	25	32	0.8	With	CN**/GNMG0904...	2

*Torque: Recommended torque (N-m) for clamping

**RE: The holder measurements are true with this insert radius

Applicable for 14 MPa pressure coolant

SPARE PARTS

Designation	Shim	Clamping screw	Wrench	Spring pin	Lever
PCLNR/L**0904-CHP-N	LSC317	LCS3	P-2.5	LSP3	LCL33

Reference pages: PCLNR/L2020X-CHP-MC, PCLNR/L-CHP-N:

Inserts → **B054 -**, **B075**, CBN → **B168 -**, **B178**, PCD → **B211 -**, Parts for coolant hose → **C115**

Lever lock toolholders with TungCap connection – 95° approach angle.
For negative 80°/70° rhombic insert. High-pressure coolant capability.

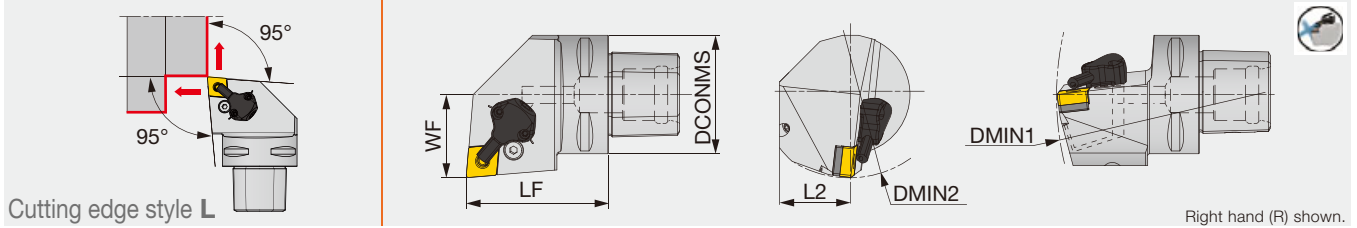

Designation	DCONMS	LF	L2	WF	DMIN1	DMIN2	RE**	Insert	Torque*
C4PCLNR/L27050-0904-CHP	40	50	25	27	140	110	0.8	CN**/GNMG0904...	2
C4PCLNR/L27050-12-CHP	40	50	25	27	140	110	0.8	CN**/GNGA1204...	3
C5PCLNR/L35060-12-CHP	50	60	32	35	165	110	0.8	CN**/GNGA1204...	3
C6PCLNR/L45065-0904-CHP	63	65	41	45	195	125	0.8	CN**/GNMG0904...	2
C6PCLNR/L45065-12-CHP	63	65	41	45	195	125	0.8	CN**/GNGA1204...	3

*Torque: Recommended torque (N-m) for clamping
Applicable for 14 MPa pressure coolant
**RE: Standard corner radius

SPARE PARTS

Designation	Shim	Clamping screw	Wrench 1	Spring pin	Lever
C*PCLNR/L**0904-CHP	LSC317	LCS3	P-2.5	LSP3	LCL33
C*PCLNR/L**-12-CHP	LSC42	LCS4	P-3	LSP4	LCL4

SPARE PARTS

Designation	Coolant unit	Mounting screw	Wrench 2	O-ring
C*PCLNR/L**0904-CHP	CU-CW-CHP	SRM3	T-8F	OR6.4X0.9N
C*PCLNR/L**-12-CHP	CU-CW-CHP	SRM3	T-8F	OR6.4X0.9N

INSERT SELECTION

Application	Precision finishing	Finishing	Medium cutting	Medium to heavy cutting
	Grade	NS9530	GT9530	T9215
Chipbreaker shape	TF	TSF	TM	TH
Cutting conditions	B004			

Application	Finishing	Medium cutting	Medium to heavy cutting
	Grade	T6215	AH6225
Chipbreaker shape	SF	SM	SH
Cutting conditions	B006		

Application	Finishing	Medium cutting	Medium to heavy cutting
	Grade	T515	T515
Chipbreaker shape	All-round	All-round	All-round
Cutting conditions	B008		

Application	Precision finishing	Finishing	Medium cutting
	Grade	DX120	DX140
Chipbreaker shape	DIA	with rake DIA	P
Cutting conditions	B010		

Application	Precision finishing	Finishing	Medium cutting
	Grade	BX470	AH8005
Chipbreaker shape	CBN	HRF	HRM
Cutting conditions	B012		

Application	Precision finishing	Finishing
	Grade	BXA10
Chipbreaker shape	CBN	CBN
Cutting conditions	B014	

Reference pages: C-PCLNR/L-CHP: Inserts → B054 -, B075, CBN → B168 -, B178, PCD → B211 -
Parts for coolant hose → C115



Double-clamp toolholder with 95° approach angle, for negative 80° rhombic ceramic inserts with dimple

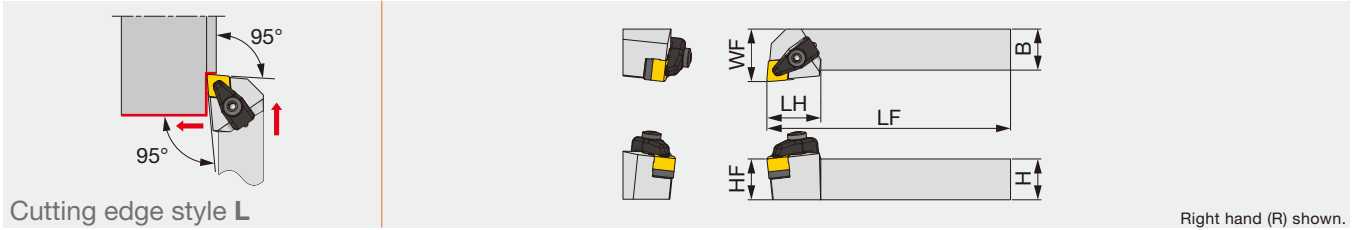

Designation	H	B	LF	LH	HF	WF	RE**	Insert	Torque*
CCLNR/L2525M1207-RD	25	25	150	33	25	32	1.2	CN*D1207...	4
CCLNR3225P1207-RD	32	25	170	33	32	32	1.2	CN*D1207...	4

*Torque: Recommended clamping torque (N·m)

**RE: Standard corner radius

SPARE PARTS

Designation	Clamp	Clamp screw	Shim	Shim screw	Spring	Wrench1	Wrench2
CCLNR/L*-RD	CCP4-A	CCS4-A	CC44-A	BH5-10-A	BP-5-A	P-3	P-4

INSERT SELECTION

K	Application	Finishing to medium cutting
	Grade	FX105
	Chipbreaker shape	
	Cutting conditions	C118

Reference pages: CCLNR/L-RD: Inserts → **B065**,
Standard cutting conditions → **C115**

TCLNR/L-F

Toolholder with carbide clamping plate, with 95° approach angle, for negative 80° rhombic ceramic inserts without hole

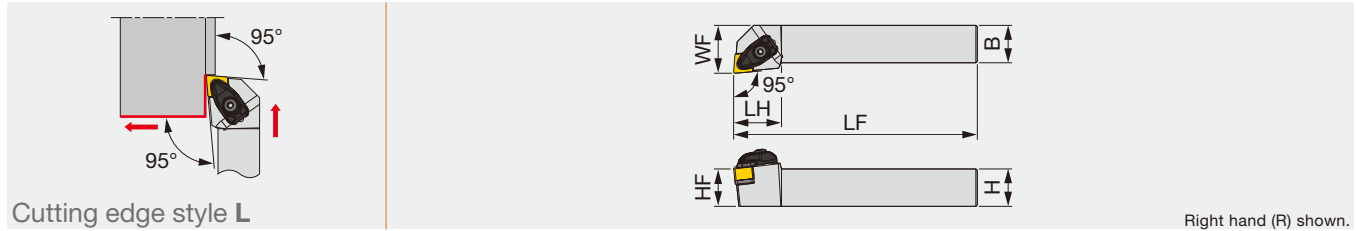

Designation	H	B	LF	LH	HF	WF	RE**	Insert
TCLNR/L2525M1204-F	25	25	150	32	25	32	0.8	CNGN1204...
TCLNR/L2525M1207-F	25	25	150	32	25	32	0.8	CNGN1207...

**RE: Standard corner radius

SPARE PARTS

Designation	Clamp	Clamp screw	Shim	Shim screw	Spring	Wrench 1	Wrench 2
TCLNR/L2525M1204-F	DCLS-4F	DLS-4A	TSC-44	BH-40050-A	DSP-4A	T-15F	P-3
TCLNR/L2525M1207-F	DCLS-4F	DLS-4A	TSC-42	BH-40050-A	DSP-4A	T-15F	P-3

INSERT

CNGN-E/T1

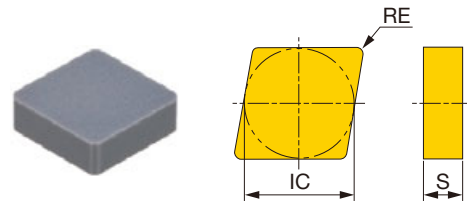

	P	M	K	N	S	H
Steel	■					
Stainless		■				
Cast iron			■			
Non-ferrous				■		
Superalloys					★	★
Hard materials						■

★ : First choice

Designation	Edge prep.*	Ceramic										RE	IC	S
		TS200	TS300											
CNGN120408-E	E	●										0.8	12.7	4.76
CNGN120412-E	E	●										1.2	12.7	4.76
CNGN120412-T1	T1	●										1.2	12.7	4.76
CNGN120708-E	E	●										0.8	12.7	7.94
CNGN120712-E	E	●	●									1.2	12.7	7.94
CNGN120716-T1	T1	●										1.6	12.7	7.94

* Types of cutting edge preparations

● : Line up

E: Low cutting force

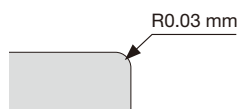

T1: Strong cutting edge

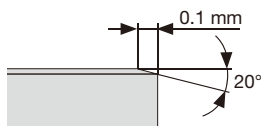

Double-clamp toolholder with 95° approach angle, for negative 80° trigon inserts

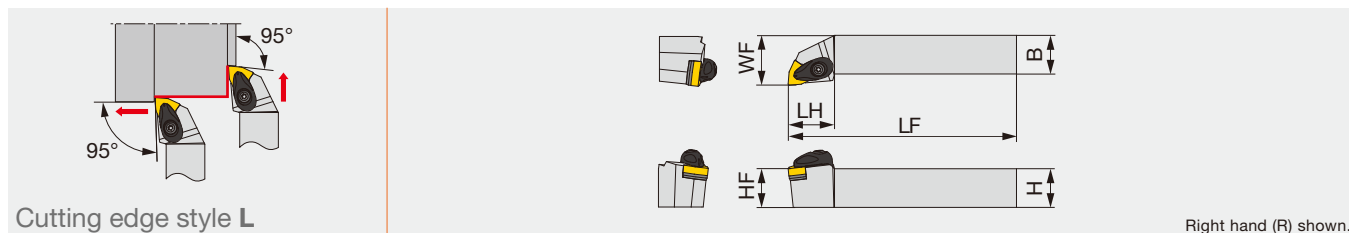

Designation	H	B	LF	LH	HF	WF	RE**	Insert	Torque*
AWLNR/L2020K0604-A	20	20	125	27	20	25	0.8	WN**0604...	3
AWLNR/L2020H08-A	20	20	100	30	20	25	0.8	WN**0804...	3
AWLNR/L2020K08-A	20	20	125	30	20	25	0.8	WN**0804...	3
AWLNR/L2525M0604-A	25	25	150	27	25	32	0.8	WN**0604...	3
AWLNR/L2525K08-A	25	25	125	30	25	32	0.8	WN**0804...	3
AWLNR/L2525M08-A	25	25	150	30	25	32	0.8	WN**0804...	3
AWLNR/L3225P08-A	32	25	170	30	32	32	0.8	WN**0804...	3

*Torque: Recommended clamping torque (N-m) **RE: Standard corner radius

C-AWLNR/L

Double-clamp toolholder, with 95° approach angle, for negative 80° trigon inserts

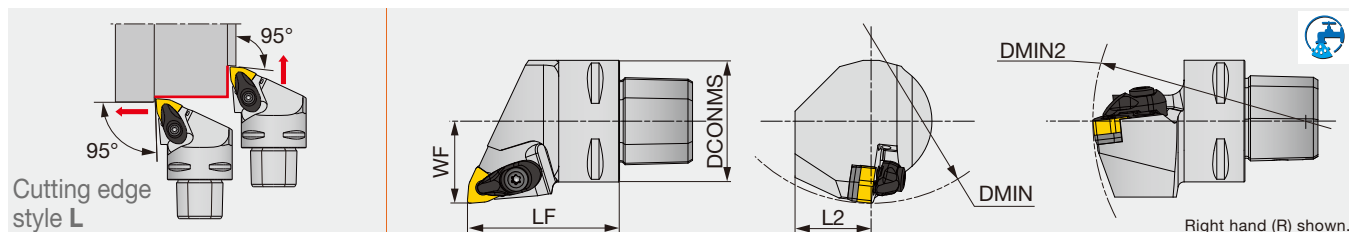

Designation	DCONMS	LF	L2	WF	DMIN	DMIN2	RE	Insert
C4AWLNR/L27050-0604N	40	50	25	27	140	110	0.8	WN**0604...
C4AWLNR/L27050-08N	40	50	25	27	-	-	0.8	WN**0804...
C6AWLNR/L45065-08N	63	65	35	45	190	110	0.8	WN**0804...

Applicable for 7 MPa coolant

The items without DMIN and DMIN2 cannot be used for boring.

SPARE PARTS

Designation	Clamp	Clamp screw	Spring	Spring pin	Shim	Shim screw	Wrench	Coolant parts
AWLNR/L**0604-A C4AWLNR/L**-0604N	ACP3S-E	ACS-5W	BP-7	SP-2.5	ASW322	CSTB-3.5	T-15F	-
AWLNR/L**08-A C4AWLNR/L**-08N	ACP4S	ACS-5W	BP-7	SP-2.5	ASW422	CSTB-3.5	T-15F	-
C6AWLNR/L**-08N	ACP4S	ACS-5W	BP-7	SP-2.5	ASW422	CSTB-3.5	T-15F	SATZ-M8X1-M3

Reference pages: AWLNR/L, C-AWLNR/L: Inserts → **B102 -**, CBN → **B187**
Parts for coolant hose → **C115**

DWLNLR/L

One-Double toolholder with 95° approach angle, for negative 80° trigon inserts

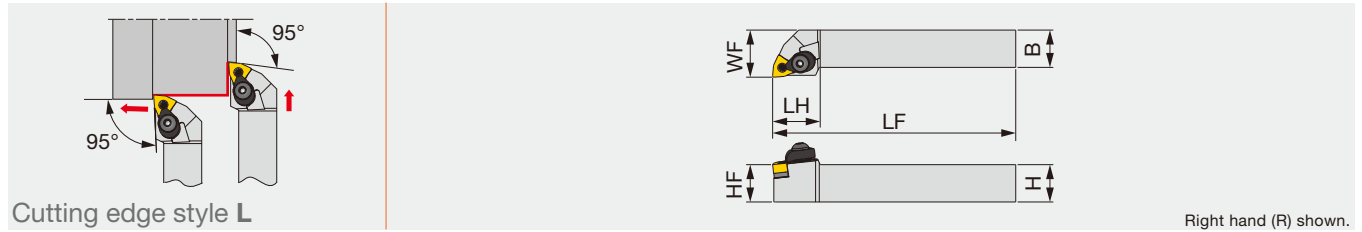

Designation	H	B	LF	LH	HF	WF	RE**	Insert
DWLNLR/L2020K06	20	20	125	25.5	20	25	0.8	WN**0604...
DWLNLR/L2020K08	20	20	125	31	20	25	0.8	WN**0804...
DWLNLR/L2525M06	25	25	150	26	25	32	0.8	WN**0604...
DWLNLR/L2525M08	25	25	150	31	25	32	0.8	WN**0804...
DWLNLR/L3225P08	32	25	170	30	32	32	0.8	WN**0804...

Note: Except for 57-type chipbreaker inserts
 **RE: Standard corner radius

SPARE PARTS									
Designation	Clamp	Lever	Piston	Clamp screw	Shim	Spring	Spring pin	Wrench1	Wrench2
DWLNLR/L**06	DCPM-33	LCL33	DPIS33	DLCS33	LSW312	BP-9	LSP3	P-2.5	P-3
DWLNLR/L**08	DCPM-43	DLCL43	DPIS43	DLCS43	LSW42	BP-10	LSP4	P-3	P-4

INSERT SELECTION

P	Application	Precision finishing	Finishing	Medium cutting	Medium to heavy cutting
	Grade	NS9530	GT9530	T9215	T9215
	Breaker Shape				
	Cutting conditions	B004			
M	Application	Finishing	Medium cutting	Medium to heavy cutting	
	Grade	T6215	AH6225	AH6225	
	Breaker Shape				
	Cutting conditions	B006			
K	Application	Finishing	Medium cutting	Medium to heavy cutting	
	Grade	T515	T515	T515	
	Breaker Shape				
	Cutting conditions	B008			
S	Application	Precision finishing	Finishing	Medium cutting	
	Grade	BX480	AH8005	AH8005	
	Breaker Shape				
	Cutting conditions	B012			
H	Application	Precision finishing	Finishing		
	Grade	BXA10	BXA20		
	Breaker Shape				
	Cutting conditions	B014			

Reference pages: DWLNLR/L: Inserts → **B102 -**, CBN → **B187**
 Parts for coolant hose → **C115**

Grade
Insert
Ext. Toolholder
Int. Toolholder
Threading
Grooving
Miniature tool
Milling cutter
Endmill
Drilling tool
Tooling System
User's Guide
Index



Lever-lock toolholder with 95° approach angle, for negative 80° trigon inserts

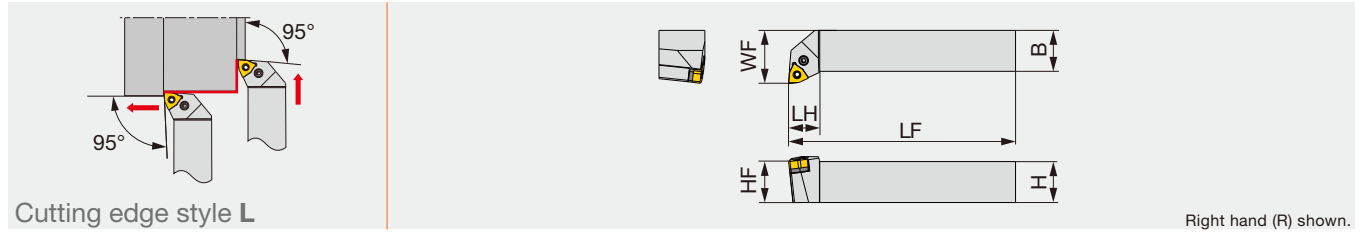

Designation	H	B	LF	LH	HF	WF	RE**	Insert	Torque*
PWLNLR/L2020K0604	20	20	125	15	20	25	0.8	WN**0604...	2
PWLNLR/L2525M0604	25	25	150	19	25	32	0.8	WN**0604...	2

*Torque: Recommended clamping torque (N·m) **RE: Standard corner radius

Designation	Shim	Clamping screw	Wrench	Spring pin	Lever
PWLNLR/L**0604	LSW312	LCS3	P-2.5	LSP3	LCL3

PWLNLR/L-CHP

Tube connection

Lever lock toolholders – 95° approach angle.
For negative 80° trigon insert. High-pressure coolant capability.

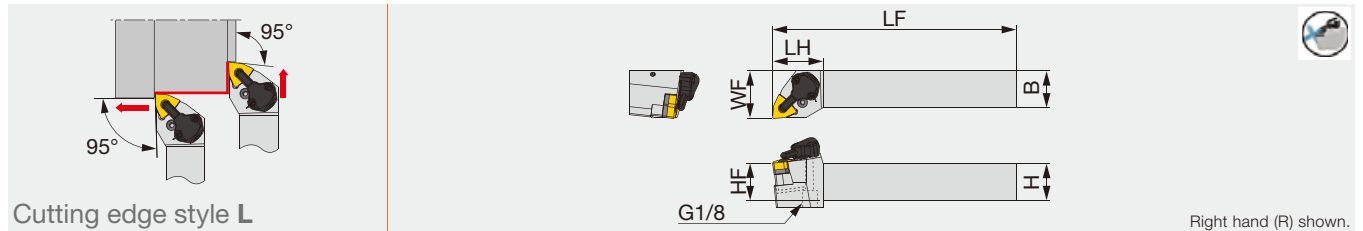

Designation	H	B	LF	LH	HF	WF	RE**	Insert	Torque*
PWLNLR/L2020K0604-CHP	20	20	125	34	20	32	0.8	WN**0604...	2
PWLNLR/L2020K08-CHP	20	20	125	34	20	32	0.8	WN**0804...	3
PWLNLR/L2525M0604-CHP	25	25	150	34	25	32	0.8	WN**0604...	2
PWLNLR/L2525M08-CHP	25	25	150	34	25	32	0.8	WN**0804...	3

*Torque: Recommended torque (N·m) for clamping
**RE: Standard corner radius

Designation	Shim	Clamping screw	Wrench 1	Spring pin	Lever
PWLNLR/L**0604-CHP	LSW312	LCS3	P-2.5	LSP3	LCL3
PWLNLR/L**08-CHP	LSW42	LCS4	P-2.5	LSP4	LCL4

Designation	Coolant unit	Mounting screw	Wrench 2	O-ring	Coolant screw	Wrench 3
PWLNLR/L**0604-CHP	CU-CW-CHP	SRM3	T-8F	OR6.4X0.9N	SRM4X4TL360	P-2
PWLNLR/L**08-CHP	CU-CW-CHP	SRM3	T-8F	OR6.4X0.9N	SRM4X4TL360	P-2

Reference pages: PWLNLR/L-Eco: Inserts → **B102 -**
PWLNLR/L-CHP: Inserts → **B102 -**, CBN → **B187**
Parts for coolant hose → **C115**

AWLNR/L-CHP-MC

Direct connection Tube connection

Double clamping tool holders-95° approach angle
For negative 80° trigon insert. High-pressure coolant capability with tube and direct connections

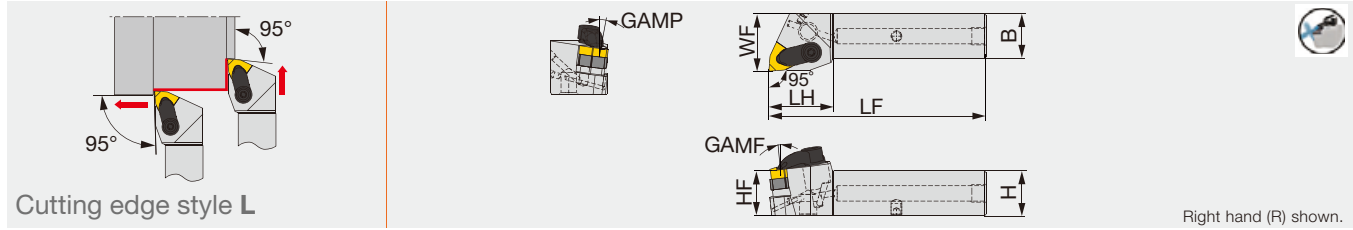

Designation	H	B	LF	LH	HF	WF	GAMP	GAMF	Insert	Torque*
AWLNR/L2020X-08-CHP-MC	20	20	106	36	20	25	6°	6°	WN**0804...	4
AWLNR/L2525X-08-CHP-MC	25	25	121	36	25	32	6°	6°	WN**0804...	4

*Torque: Recommended torque (N-m) for clamping
Applicable for 14 MPa pressure coolant

SPARE PARTS

Designation	Clamp set	Shim	Shim screw	screw for tube connection	Coolant plug	O-ring	Wrench 1
AWLNR**X-08-CHP-MC	LCGL-4JCSET	RWT443	SR14-506	PLUGG1/8-6.5TL360	SRM5X5 DIN913TL360	OR4X3NBR70	KEYV-T20
AWLNR**X-08-CHP-MC	LCGR-4JCSET	RWT443	SR14-506	PLUGG1/8-6.5TL360	SRM5X5 DIN913TL360	OR4X3NBR70	KEYV-T20

PWLNR/L2020X-CHP-MC

Direct connection

Lever lock toolholders – 95° approach angle.
For negative 80° trigon insert. High-pressure coolant capability with bottom direct connection

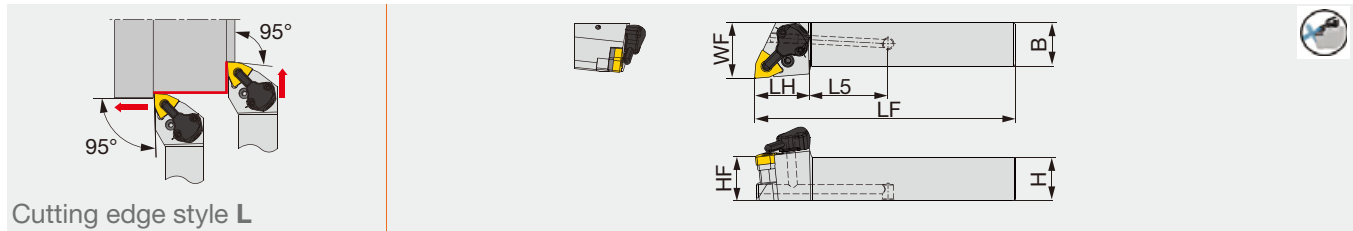

Designation	H	B	LF	LH	HF	L5	WF	Insert	Torque*
PWLNR/L2020X06-CHP-MC	20	20	97	27	20	29	25	WN**0604...	2
PWLNR/L2020X08-CHP-MC	20	20	97	27	20	29	25	WN**0804...	3

*Torque: Recommended torque (N-m) for clamping
Applicable for 30 MPa pressure coolant

SPARE PARTS

Designation	Shim	Spring	Lever	Spring	Spring pin	Wrench	Coolant unit	Wrench	Coolant plug	Wrench
PWLNR/L2020X06-CHP-MC	TWN3	SP3	LR3	SR117-2014	PN3-4	HW2.5	CU-CW-CHP	T-8/5	SRM5X5 DIN913TL360	-
PWLNR/L2020X08-CHP-MC	TWN443	SP4	LR4DH	SR117-2010	PN3-4L	HW2.5	CU-CW-CHP	T-8/5	SRM5X5 DIN913TL360	HW3.0

INSERT SELECTION

P

Application	Precision finishing	Finishing	Medium cutting	Medium to heavy cutting
Grade	NS9530	GT9530	T9215	T9215
Breaker Shape	TF	TSF	TM	TH
Images				
Cutting conditions	B004			

M

Application	Finishing	Medium cutting	Medium to heavy cutting
Grade	T6215	AH6225	AH6225
Breaker Shape	SF	SM	SH
Images			
Cutting conditions	B006		

K

Application	Finishing	Medium cutting	Medium to heavy cutting
Grade	T515	T515	T515
Breaker Shape	All-round	All-round	All-round
Images			
Cutting conditions	B008		

S

Application	Precision finishing	Finishing	Medium cutting
Grade	BX480	AH8005	AH8005
Breaker Shape	CBN	HRF	HRM
Images			
Cutting conditions	B012		

H

Application	Precision finishing	Finishing
Grade	BXA10	BXA20
Breaker Shape	CBN	CBN
Images		
Cutting conditions	B014	

Reference pages: AWLNR/L-CHP-MC, PWLNR/L2020X-CHP-MC:
Inserts → **B102** -, CBN → **B187**
Parts for coolant hose → **C115**

Grade
Insert
Ext. Toolholder
Int. Toolholder
Threading
Grooving
Miniature tool
Milling cutter
Endmill
Drilling tool
Tooling System
User's Guide
Index



Lever lock toolholders with TungCap connection – 95° approach angle.
For negative 80° trigon insert. High-pressure coolant capability.

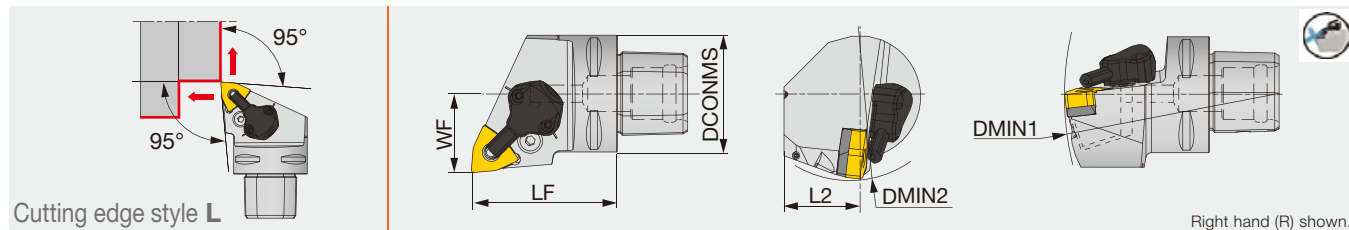

Designation	DCONMS	LF	L2	WF	DMIN1	DMIN2	RE**	Insert	Torque*
C4PWLNLR/L27050-0604-CHP	40	50	25	27	140	110	0.8	WN**0604...	2
C4PWLNLR/L27050-08-CHP	40	50	25	27	140	110	0.8	WN**0804...	3
C6PWLNLR/L45065-08-CHP	63	65	41	45	190	110	0.8	WN**0804...	3

*Torque: Recommended torque (N-m) for clamping
Applicable for 14 MPa pressure coolant
**RE: Standard corner radius

SPARE PARTS

Designation	Shim	Clamping screw	Wrench 1	Spring pin	Lever
C*PWLNLR/L**0604-CHP	LSW312	LCS3	P-2.5	LSP3	LCL3
C*PWLNLR/L**-08-CHP	LSW42BL	LCS4	P-3	LSP4	LCL4

SPARE PARTS

Designation	Coolant unit	Mounting screw	Wrench 2	O-ring
C*PWLNLR/L**0604-CHP	CU-CW-CHP	SRM3	T-8F	OR6.4X0.9N
C*PWLNLR/L**-08-CHP	CU-CW-CHP	SRM3	T-8F	OR6.4X0.9N

INSERT SELECTION

Application	Precision finishing	Finishing	Medium cutting	Medium to heavy cutting
	Grade	NS9530	GT9530	T9215
Breaker Shape	TF	TSF	TM	TH
Cutting conditions: B004				

Application	Finishing	Medium cutting	Medium to heavy cutting
	Grade	T6215	AH6225
Breaker Shape	SF	SM	SH
Cutting conditions: B006			

Application	Finishing	Medium cutting	Medium to heavy cutting
	Grade	T515	T515
Breaker Shape	All-round	All-round	All-round
Cutting conditions: B008			

Application	Precision finishing	Finishing	Medium cutting
	Grade	BX480	AH8005
Breaker Shape	CBN	HRF	HRM
Cutting conditions: B012			

Application	Precision finishing	Finishing
	Grade	BXA10
Breaker Shape	CBN	CBN
Cutting conditions: B012		

Reference pages: C-PWLNLR/L-CHP: Inserts → **B102 -**, CBN → **B187**
Parts for coolant hose → **C115**

Screw-on toolholder with 95° approach angle, for negative 80° trigon inserts

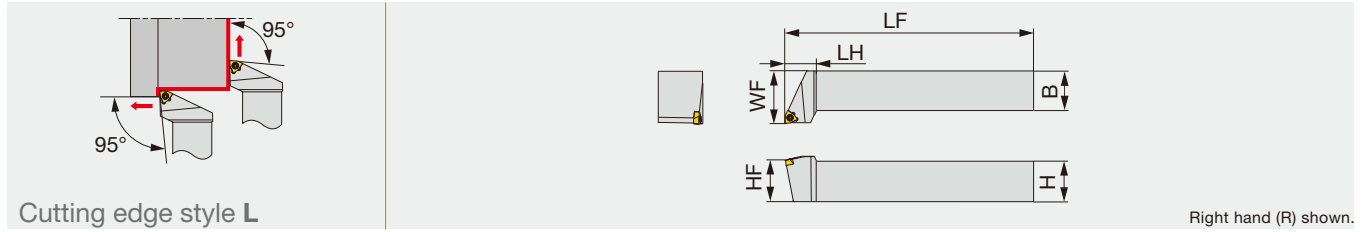

Designation	H	B	LF	LH	HF	WF	RE**	Insert	Torque*
JSWLXR/L2020K04	20	20	125	15	20	25	0.4	WXGU0403**L/R...	0.9
JSWLXR/L2525M04	25	25	150	19	25	32	0.4	WXGU0403**L/R...	0.9

*Torque: Recommended clamping torque (N-m) **RE: Standard corner radius
Note: Use right-hand toolholders (R) with left-hand inserts (L); and left-hand toolholders (L) with right-hand inserts (R).

JSWL2XR/L

Screw-on toolholder with 95° approach angle, for WXGU inserts

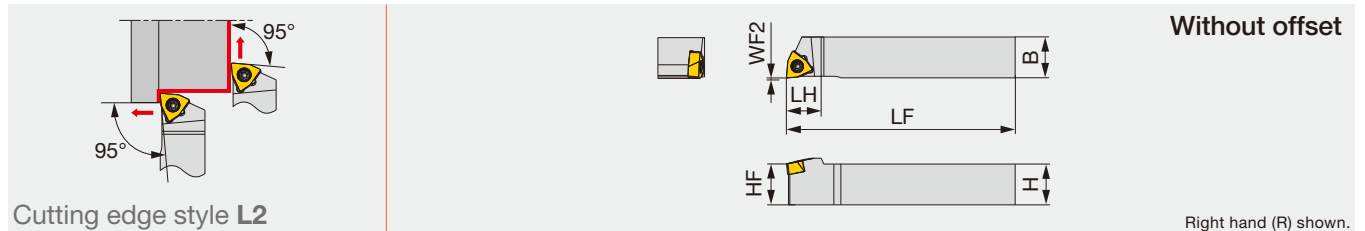

Designation	H	B	LF	LH	HF	WF2	RE**	Insert	Torque*
JSWL2XR/L1010X04	10	10	120	11	10	0	0.2	WXGU0403**L/R...	0.9
JSWL2XR/L1212F04	12	12	85	11	12	0	0.2	WXGU0403**L/R...	0.9
JSWL2XR/L1212X04	12	12	120	11	12	0	0.2	WXGU0403**L/R...	0.9
JSWL2XR/L1616X04	16	16	120	13	16	0	0.2	WXGU0403**L/R...	0.9
JSWL2XR/L2020H04	20	20	100	13	20	0	0.2	WXGU0403**L/R...	0.9

*Torque: Recommended clamping torque (N-m) **RE: Standard corner radius
Note: Use right-hand toolholders (R) with left-hand inserts (L); and left-hand toolholders (L) with right-hand inserts (R).

SPARE PARTS		
Designation	Clamping screw	Wrench
JSWLXR/L...	SR34-514	T-7F
JSWL2XR/L...		

INSERT SELECTION

Swiss lathes

Application	Finishing		Medium cutting	
	Grade	SH725	Grade	AH725
Chipbreaker shape	JSS	JTS	JSS	JTS
Cutting conditions	C118			

Small CNC lathes

Application	Finishing		Medium cutting	
	Grade	AH725	Grade	AH8015
Chipbreaker shape	SS	TS	SS	TS
Cutting conditions	C118			

Reference pages: JSWLXR/L, JSWL2XR/L: Inserts → **B157** -
Standard cutting conditions → **C118**



PTL2NR/L

Lever-lock toolholder with 95° approach angle, for negative 60° triangular inserts

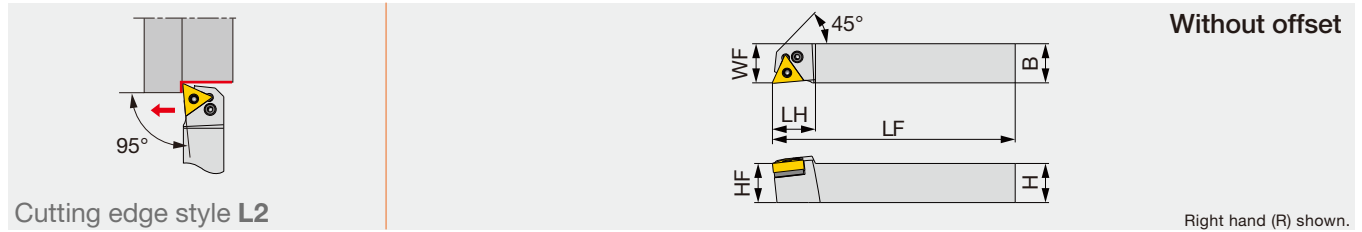

Designation	H	B	LF	LH	HF	WF	RE**	Insert	Torque*
PTL2NR/L2020H16	20	20	100	22	20	20	0.4	TN**1604...	2

*Torque: Recommended clamping torque (N·m)
**RE: Standard corner radius

SPARE PARTS

Designation	Shim	Clamping screw	Wrench	Spring pin	Lever
PTL2NR/L...	LST317 D30	LCS3	P-2.5	LSP3	LCL3

INSERT SELECTION

Application	Precision finishing	Finishing	Medium cutting	Medium to heavy cutting
	Grade	NS9530	GT9530	T9215
Chipbreaker shape	TF	TSF	TM	TH
Cutting conditions	B004			

Application	Finishing	Medium cutting
	Grade	T6215
Chipbreaker shape	SF	SM
Cutting conditions	B006	

Application	Finishing	Medium cutting	Medium to heavy cutting
	Grade	T515	T515
Chipbreaker shape	All-round	All-round	All-round
Cutting conditions	B008		

Application	Precision finishing	Finishing	Medium cutting
	Grade	DX120	DX140
Chipbreaker shape	DIA	with rake DIA	P
Cutting conditions	B010		

Application	Precision finishing	Finishing	Medium cutting
	Grade	BX470	AH8005
Chipbreaker shape	CBN	HRF	HRM
Cutting conditions	B012		

Application	Precision finishing	Finishing
	Grade	BXA10
Chipbreaker shape	CBN	CBN
Cutting conditions	B014	

SCLCR/L

Screw-on toolholder with 95° approach angle, for positive 80° rhombic inserts

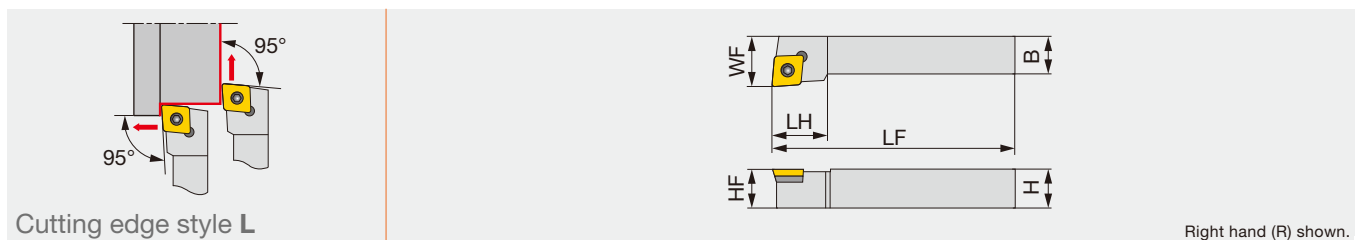

Designation	H	B	LF	LH	HF	WF	RE**	Insert
SCLCR/L1616H09	16	16	100	16	16	20	0.8	CC**09T3...
SCLCR/L2020K12	20	20	125	20	20	25	0.8	CC**1204...

**RE: Standard corner radius

SPARE PARTS

Designation	Clamping screw	Shim screw	Shim	Wrench1	Wrench2
SCLCR/L1616H09	CSTB-3.5L	DTS5-3.5	SSC32	P-3.5	T-15F
SCLCR/L2020K12	CSTB-4F	DTS6-4	SSC4T3	P-4	T-15F

Reference pages: PTL2NR/L: Inserts → B087 -, CBN → B182 -, PCD → B212
SCLCR/L: Inserts → B112 -, CBN → B189 -, PCD → B213

PCLCR/L1616X09S-CHP-MC

Direct connection

Lever lock toolholders – 95° approach angle.
For positive 80° rhombic insert. High-pressure coolant capability with bottom direct connection

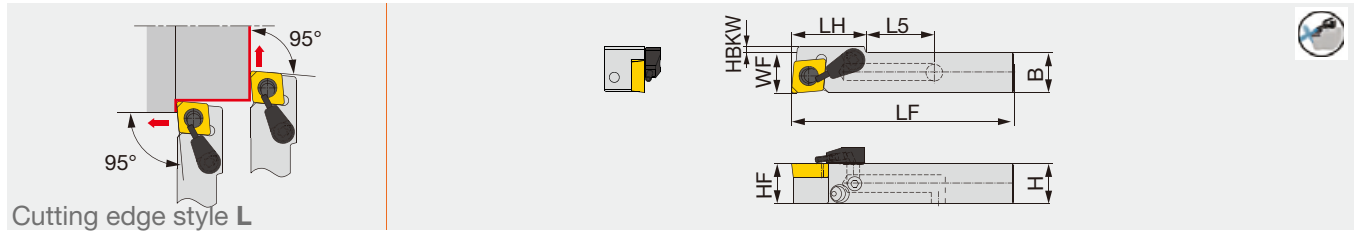

Designation	H	B	LF	LH	L5	HF	WF	HBKW	Insert
PCLCR/L1616X09S-CHP-MC	16	16	71	23	17	16	16.2	-	CC**09T3...

Applicable for 14 MPa pressure coolant

Designation	Lever	Pin	Clamping screw	Wrench	Coolant plug	Coolant unit
PCLCR/L1616X09S-CHP-MC	SLLV-3	SLPI-3	SR10400150	HW2.5/5	SR5/16UNFTL360	S-CU-CHP

TUNGCAP

C-SCLCL-CHP

Screw-on toolholder, with 95° approach angle, for positive 80° rhombic inserts, with high pressure coolant capability

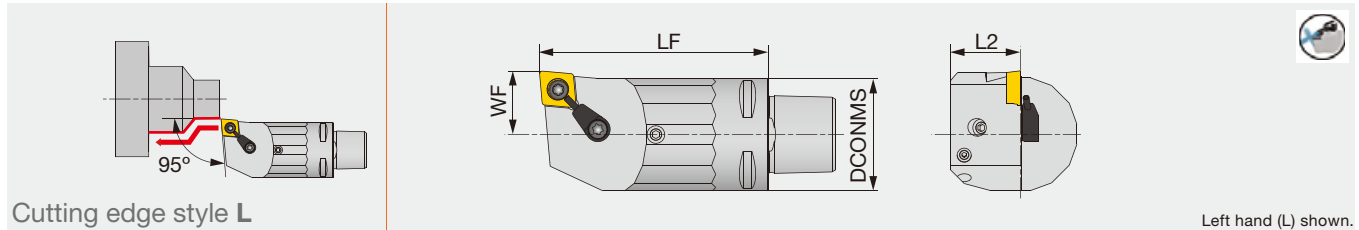

Designation	DCONMS	LF	L2	WF	RE	Insert
C3SCLCL18040-09-CHP	32	40	20	18	0.8	CC**09T3...
C3SCLCL18065-09-CHP	32	65	20	18	0.8	CC**09T3...

Applicable for 14 MPa pressure coolant
Cannot be used for boring

Designation	Clamping screw	Coolant unit	Wrench
C3SCLCL...	CSTB-4S	S-CU-CHP	T-15F

INSERT SELECTION

P	Application	Precision finishing	Finishing	Finishing to medium cutting	Medium cutting	M	Application	Precision finishing	Finishing	Finishing to medium cutting	Medium cutting
	Grade	NS9530	NS9530	T9215	T9215		Grade	GH330	AH6225	AH6225	AH6225
	Chipbreaker shape	01	PSS	PS	PM		Chipbreaker shape	W**	PSS	PS	PM
	Cutting conditions	B016					Cutting conditions	B018			
K	Application	Finishing to medium cutting					N	Application	Precision finishing	Finishing	Medium cutting
	Grade	T515						Grade	DX120	DX140	KS05F
	Chipbreaker shape	CM						Chipbreaker shape	DIA	with rake DIA	AL
	Cutting conditions	B020					Cutting conditions	B022			
S	Application	Finishing	Finishing to medium cutting					H	Application	Precision finishing	Finishing
	Grade	AH8015	AH8015						Grade	BXA10	BXA20
	Chipbreaker shape	PSS	PS						Chipbreaker shape	CBN	CBN
	Cutting conditions	B024					Cutting conditions	B026			

Reference pages: PCLCR/L1616X09S-CHP-MC, C-SCLCL-CHP:
Inserts → **B112 -**, CBN → **B189 -**, PCD → **B213**
Parts for coolant hose → **C115**

Double-clamp toolholder with 93° approach angle, for negative 60° triangular inserts

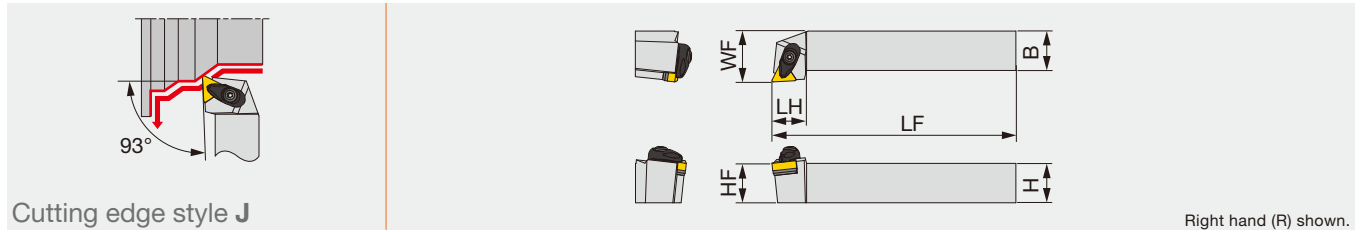

Designation	H	B	LF	LH	HF	WF	RE**	Insert	Torque*
ATJNR/L2020K16-A	20	20	125	22	20	25	0.8	TN**1604...	3
ATJNR/L2525M16-A	25	25	150	22	25	32	0.8	TN**1604...	3

*Torque: Recommended clamping torque (N·m) **RE: Standard corner radius

C-ATJNR/L

Double-clamp toolholder, with 93° approach angle, for negative 60° triangular inserts

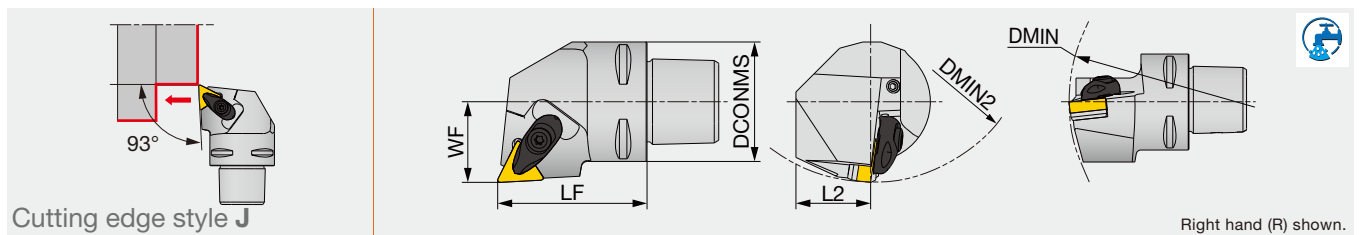

Designation	DCONMS	LF	L2	WF	DMIN	DMIN2	RE	Insert
C4ATJNR/L27050-16N	40	50	25	27	140	110	0.8	TN**1604...

Applicable for 7 MPa coolant

SPARE PARTS

Designation	Clamp	Clamp screw	Spring	Spring pin	Shim	Shim screw	Wrench
ATJNR/L**16-A C4ATJNR/L**16N	ACP3S	ACS-5W	BP-7	SP-2.5	AST322	CSTB-3.5	T-15F

ISO ETURN

PTJNR/L-Eco

Lever-lock toolholder with 93° approach angle, for negative triangular inserts

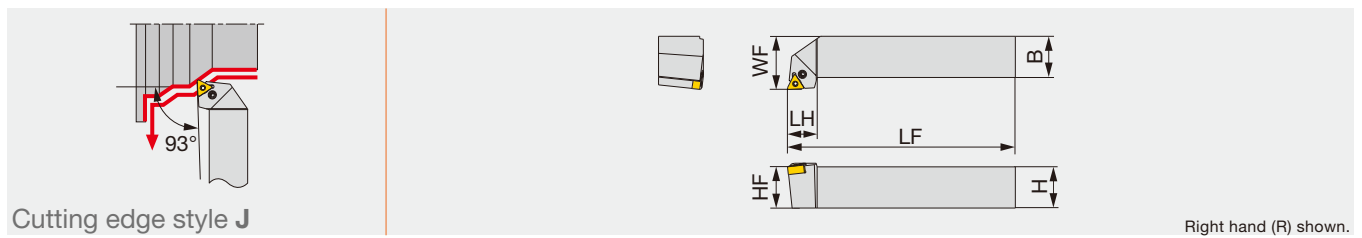

Designation	H	B	LF	LH	HF	WF	RE**	Insert	Torque*
PTJNR/L2525M1104	25	25	150	18	25	32	0.8	TN**1104...	2

*Torque: Recommended clamping torque (N·m)

**RE: Standard corner radius

SPARE PARTS

Designation	Clamping screw	Wrench	Lever
PTJNR/L2525M1104	LCS23A	P-2.5	LCL23

Reference pages: ATJNR/L, C-ATJNR/L: Inserts → **B087 -**, CBN → **B182 -**, PCD → **B212**
PTJNR/L-Eco: Inserts → **B087 -**

Lever-lock external turning toolholder (P type)

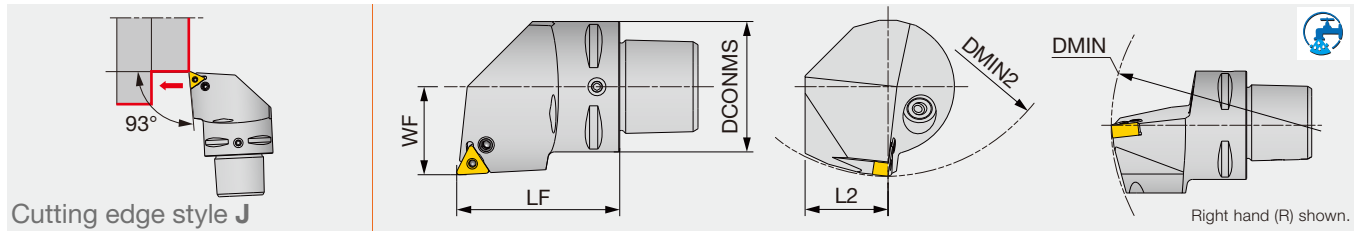

Designation	DCONMS	LF	L2	WF	DMIN	DMIN2	RE**	Insert
C4PTJNR/L27050-1104N	40	50	25	27	140	110	0.8	TN**1104...

**RE: The holder measurements are true with this insert radius
Applicable for 7 MPa coolant

SPARE PARTS

Designation	Clamping screw	Wrench	Lever	Coolant parts
C4PTJNR/L27050-1104N	LCS23A	P-2.5	LCL23	SATZ-M8X1-M3

WTJNR/L

Wedge-on toolholder with 93° approach angle, for negative 60° triangular inserts

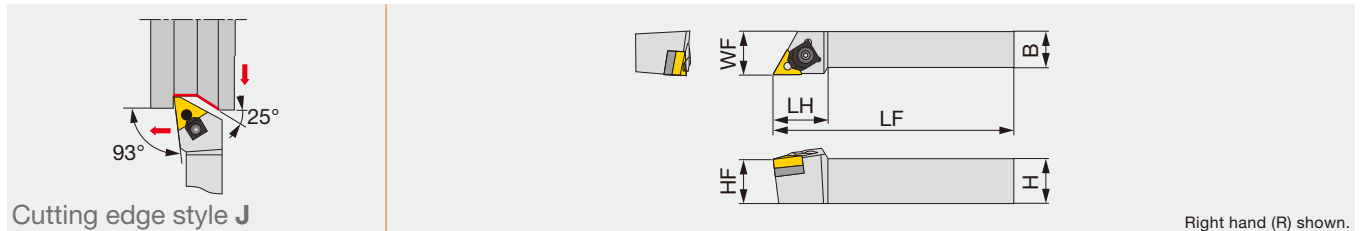

Designation	H	B	LF	LH	HF	WF	RE**	Insert
WTJNR2020	20	20	125	31	20	25	0.8	TN**1604...
WTJNR/L2525M3	25	25	150	31	25	32	0.8	TN**1604...

**RE: Standard corner radius

SPARE PARTS

Designation	Clamp	E-ring	Nut	Pin	Clamping screw	Shim	Wrench
WTJNR2020	WCW3	5103-25	WCN3S	WCP3S	WCS3	WST33	P-3
WTJNR/L2525M3	WCW3	5103-25	WCN3	WCP3S	WCS3	WST33	P-3

INSERT SELECTION

Application	Precision finishing	Finishing	Medium cutting	Medium to heavy cutting
	Grade	NS9530	GT9530	T9215
Chipbreaker shape	TF	TSF	TM	TH
Cutting conditions	B004			

Application	Finishing	Medium cutting
	Grade	T6215
Chipbreaker shape	SF	SM
Cutting conditions	B006	

Application	Finishing	Medium cutting	Medium to heavy cutting
	Grade	T515	T515
Chipbreaker shape	All-round	All-round	All-round
Cutting conditions	B008		

Application	Precision finishing	Finishing	Medium cutting
	Grade	DX120	DX140
Chipbreaker shape	DIA	DIA with rake	P
Cutting conditions	B010		

Application	Precision finishing	Finishing	Medium cutting
	Grade	BX470	AH8005
Chipbreaker shape	CBN	HRF	HRM
Cutting conditions	B012		

Application	Precision finishing	Finishing
	Grade	BXA10
Chipbreaker shape	CBN	CBN
Cutting conditions	B014	

Reference pages: C-PTJNR/L: Inserts → **B087 -**

WTJNR/L: Inserts → **B087 -**, CBN → **B182 -**, PCD → **B212**



Double-clamp toolholder with 93° approach angle, for negative 55°/45° rhombic inserts

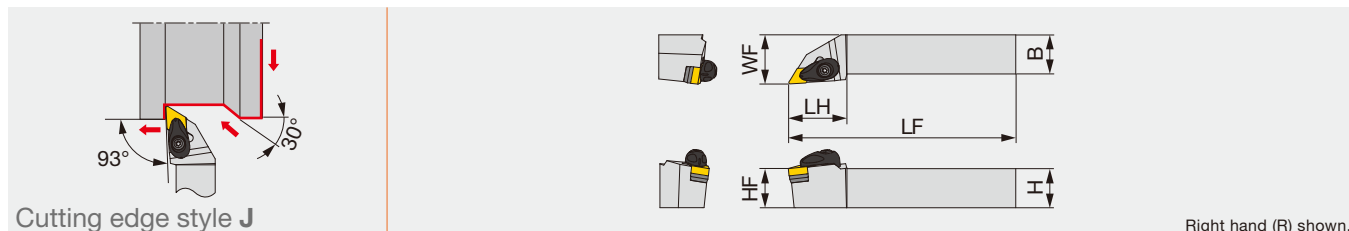

Cutting edge style J

Right hand (R) shown.

Designation	H	B	LF	LH	HF	WF	RE**	Insert	Torque*
ADJNR/L2020K1104-A	20	20	125	30	20	25	0.8	DN**/FNMG1104...	3
ADJNR/L2020K15-A	20	20	125	36	20	25	0.8	DN**/FNGA1504...	3
ADJNR/L2020K1506-A	20	20	125	36	20	25	0.8	DN**/FNGA1506...	3
ADJNR/L2525M1104-A	25	25	150	30	25	32	0.8	DN**/FNMG1104...	3
ADJNR/L2525M15-A	25	25	150	36	25	32	0.8	DN**/FNGA1504...	3
ADJNR/L2525M1506-A	25	25	150	36	25	32	0.8	DN**/FNGA1506...	3
ADJNR/L3225P15-A	32	25	170	36	32	32	0.8	DN**/FNGA1504...	3

*Torque: Recommended clamping torque (N-m)

**RE: Standard corner radius

C-ADJNR/L

Double-clamp toolholder, with 93° approach angle, for negative 55°/45° rhombic inserts

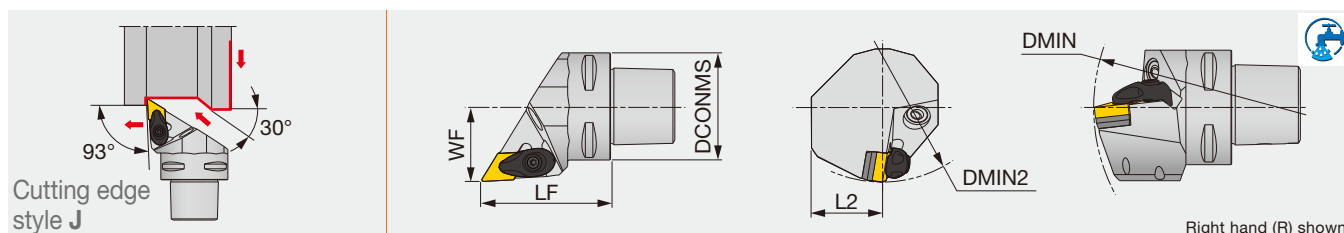

Cutting edge style J

Right hand (R) shown.

Designation	DCONMS	LF	L2	WF	DMIN	DMIN2	RE	Insert
C3ADJNR/L22050-1104N	32	50	20	22	121	85	0.8	DN**/FNMG1104...
C4ADJNR/L27050-1104N	40	50	25	27	145	110	0.8	DN**/FNMG1104...
C4ADJNR/L27050-15N	40	50	25	27	145	110	0.8	DN**/FNGA1504...
C5ADJNR/L35060-15N	50	60	32	35	165	110	0.8	DN**/FNGA1504...
C6ADJNR/L45065-1104N	63	65	35	45	190	110	0.8	DN**/FNMG1104...
C6ADJNR/L45065-15N	63	65	41	45	190	110	0.8	DN**/FNGA1504...
C6ADJNR/L45135-15N	63	135	41	45	190	110	0.8	DN**/FNGA1504...

Applicable for 7 MPa coolant

Option: ASD423 (Shim for DN**1506**)

SPARE PARTS

Designation	Clamp	Clamp screw	Coolant parts	Shim	Shim screw	Spring	Spring pin	Wrench
ADJNR/L**1104-A	ACP3S-E	ACS-5W	-	ASD322	CSTB-3.5	BP-7	SP-2.5	T-15F
ADJNR/L**15-A	ACP4S	ACS-5W	-	ASD432	CSTB-3.5	BP-7	SP-2.5	T-15F
ADJNR/L**1506-A	ACP4S	ACS-5W	-	ASD423	CSTB-3.5	BP-7	SP-2.5	T-15F
C4ADJN*27050-15N	ACP4S	ACS-5W	SATZ-M10X1-M5	ASD432	CSTB-3.5	BP-7	SP-2.5	T-15F
C5ADJN*35060-15N	ACP4S	ACS-5W	SATZ-M10X1-M5	ASD432	CSTB-3.5	BP-7	SP-2.5	T-15F
C6ADJN*45065-15N	ACP4S	ACS-5W	SATZ-M10X1-M5	ASD432	CSTB-3.5	BP-7	SP-2.5	T-15F
C6ADJN*45135-15N	ACP4S	ACS-5W	SATZ-M10X1-M5	ASD432	CSTB-3.5	BP-7	SP-2.5	T-15F

Reference pages: ADJNR/L, C-ADJNR/L: Inserts → B066 -, B075 -, CBN → B172 -, B176 -,PCD → B211

DDJNR/L

One-Double toolholder with 93° approach angle, for negative 55°/45° rhombic inserts

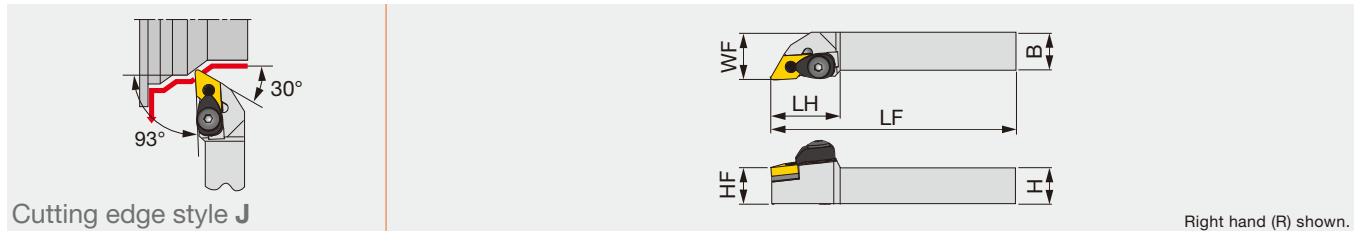

Right hand (R) shown.

Designation	H	B	LF	LH	HF	WF	RE**	Insert
DDJNR/L2020K15	20	20	125	38	20	25	0.8	DN**/FNGA1504...
DDJNR/L2020K1506	20	20	125	38	20	25	0.8	DN**/FNGA1506...
DDJNR/L2525M15	25	25	150	38	25	32	0.8	DN**/FNGA1504...
DDJNR/L2525M1506	25	25	150	38	25	32	0.8	DN**/FNGA1506...
DDJNR/L3225P15	32	25	170	38	32	32	0.8	DN**/FNGA1504...
DDJNR/L3225P1506	32	25	170	38	32	32	0.8	DN**/FNGA1506...

Note: Except for 57-type chipbreaker inserts
 **RE: Standard corner radius

SPARE PARTS									
Designation	Clamp	Lever	Piston	Clamp screw	Shim	Spring	Spring pin	Wrench1	Wrench2
DDJNR/L**15	DCPM-43	DLCL43	DPIS43	DLCS43	LSD42	BP-10	LSP4	P-3	P-4
DDJNR/L**1506	DCPM-43	DLCL43	DPIS44	DLCS43	LSD42	BP-10	LSP4	P-3	P-4

INSERT SELECTION

P	Application	Precision finishing	Finishing	Medium cutting	Medium to heavy cutting
	Grade	NS9530	GT9530	T9215	T9215
	Chipbreaker shape	TF	TSF	TM	TH
	Cutting conditions	B004			
M	Application	Finishing	Medium cutting	Medium to heavy cutting	
	Grade	T6215	AH6225	AH6225	
	Chipbreaker shape	SF	SM	SH	
	Cutting conditions	B006			
K	Application	Finishing	Medium cutting	Medium to heavy cutting	
	Grade	T515	T515	T515	
	Chipbreaker shape	All-round	All-round	All-round	
	Cutting conditions	B008			
N	Application	Precision finishing	Finishing	Medium cutting	
	Grade	DX120	DX140	TH10	
	Chipbreaker shape	DIA	with rake DIA	P	
	Cutting conditions	B010			
S	Application	Precision finishing	Finishing	Medium cutting	
	Grade	BX470	AH8005	AH8005	
	Chipbreaker shape	CBN	HRF	HRM	
	Cutting conditions	B012			
H	Application	Precision finishing	Finishing		
	Grade	BXA10	BXA20		
	Chipbreaker shape	CBN	CBN		
	Cutting conditions	B014			

Reference pages: DDJNR/L: Inserts → B066 -, B075 -, CBN → B172 -, B176 -,PCD → B211



PDJNR/L

Lever-lock toolholder with 93° approach angle, for negative 55°/45° rhombic inserts

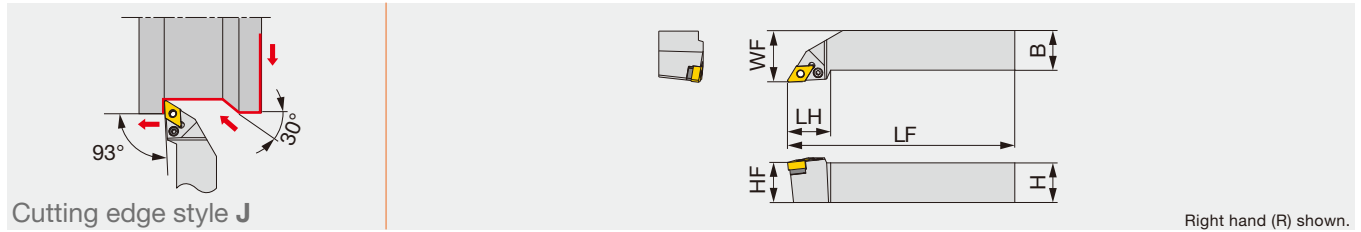

Right hand (R) shown.

Designation	H	B	LF	LH	HF	WF	RE**	Insert	Torque*
PDJNR/L1616H1104	16	16	100	27	16	20	0.8	DN**/FNMG1104...	2
PDJNR/L1616H11	16	16	100	27	16	20	0.8	DN**/FNMG1104...	2
PDJNR/L2020K1104	20	20	125	27	20	25	0.8	DN**/FNMG1104...	2
PDJNR/L2020K11	20	20	125	27	20	25	0.8	DN**/FNMG1104...	2
PDJNR/L2020	20	20	125	34	20	25	0.8	DN**/FNGA1504...	3
PDJNR2020K15E	20	20	125	36	20	25	0.8	DN**/FNGA1506...	3
PDJNR/L2520	25	20	150	34	25	25	0.8	DN**/FNGA1504...	3
PDJNR/L2525M1104	25	25	150	27	25	32	0.8	DN**/FNMG1104...	2
PDJNR/L2525M11	25	25	150	27	25	32	0.8	DN**/FNMG1104...	2
PDJNR/L2525	25	25	150	34	25	32	0.8	DN**/FNGA1504...	3
PDJNR/L2525M15E	25	25	150	36	25	32	0.8	DN**/FNGA1506...	3
PDJNR/L3225	32	25	170	32	32	32	0.8	DN**/FNGA1504...	3
PDJNR3225P15E	32	25	170	36	32	34	0.8	DN**/FNGA1506...	3

*Torque: Recommended clamping torque (N·m)

**RE: Standard corner radius

SPARE PARTS

Designation	Shim	Clamping screw	Wrench	Spring pin	Lever
PDJNR/L****11/1104	ELSD32	LCS3	P-2.5	LSP3	LCL33L
PDJNR/L2020	LSD42	LCS4	P-3	LSP4	LCL4
PDJNR2020K15E	ELSD42	ELCS4	P-3	LSP4S	LCL44
PDJNR/L2520	LSD42	LCS4	P-3	LSP4	LCL4
PDJNR/L2525	LSD42	LCS4	P-3	LSP4	LCL4
PDJNR/L2525M15E	ELSD42	ELCS4	P-3	LSP4S	LCL44
PDJNR/L3225	LSD42	LCS4	P-3	LSP4	LCL4
PDJNR3225P15E	ELSD42	ELCS4	P-3	LSP4S	LCL44

INSERT SELECTION

Application	Precision finishing	Finishing	Medium cutting	Medium to heavy cutting
	Grade	Grade	Grade	Grade
	NS9530	GT9530	T9215	T9215
Chipbreaker shape	TF	TSF	TM	TH
Cutting conditions	B004			

Application	Finishing	Medium cutting	Medium to heavy cutting
	Grade	Grade	Grade
	T6215	AH6225	AH6225
Chipbreaker shape	SF	SM	SH
Cutting conditions	B006		

Application	Finishing	Medium cutting	Medium to heavy cutting
	Grade	Grade	Grade
	T515	T515	T515
Chipbreaker shape	All-round	All-round	All-round
Cutting conditions	B008		

Application	Precision finishing	Finishing	Medium cutting
	Grade	Grade	Grade
	DX120	DX140	TH10
Chipbreaker shape	DIA	DIA with rake	P
Cutting conditions	B010		

Application	Precision finishing	Finishing	Medium cutting
	Grade	Grade	Grade
	BX470	AH8005	AH8005
Chipbreaker shape	CBN	HRF	HRM
Cutting conditions	B012		

Application	Precision finishing	Finishing
	Grade	Grade
	BXA10	BXA20
Chipbreaker shape	CBN	CBN
Cutting conditions	B014	

Reference pages: PDJNR/L: Inserts → B066 -, B075 -, CBN → B172 -, B176 -,PCD → B211

PDJNR/L-CHP

Tube connection

Lever lock toolholders – 93° approach angle.
For negative 55°/45° rhombic insert. High-pressure coolant capability.

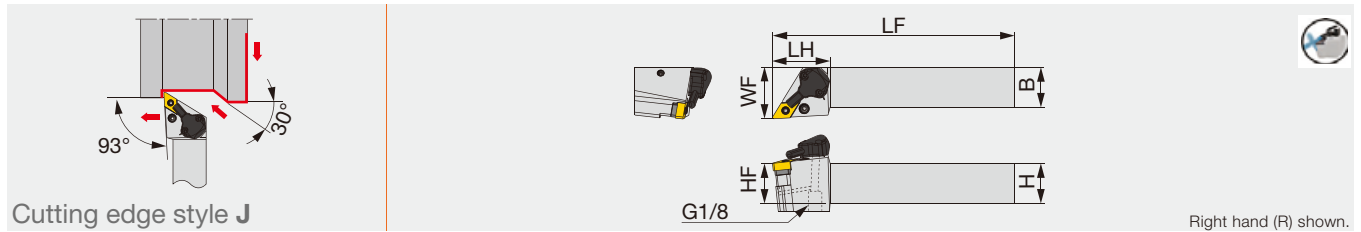

Designation	H	B	LF	LH	HF	WF	RE**	Insert	Torque*
PDJNR/L2020K1104-CHP	20	20	125	36	20	32	0.8	DN**/FNMG1104...	2
PDJNR/L2020K15-CHP	20	20	125	36	20	32	0.8	DN**/FNGA1504...	3
PDJNR/L2525M1104-CHP	25	25	150	36	25	32	0.8	DN**/FNMG1104...	2
PDJNR/L2525M15-CHP	25	25	150	36	25	32	0.8	DN**/FNGA1504...	3

*Torque: Recommended torque (N·m) for clamping
**RE: Standard corner radius

SPARE PARTS

Designation	Shim	Clamping screw	Wrench 1	Spring pin	Lever
PDJNR/L**1104-CHP	ELSD32	LCS3	P-2.5	LSP3	LCL33L
PDJNR/L**15-CHP	LSD43A	LCS4	P-3	LSP4	LCL4

SPARE PARTS

Designation	Coolant unit	Mounting screw	Wrench 2	O-ring	Coolant screw	Wrench 3
PDJNR/L**1104-CHP	CU-D-CHP	SRM3	T-8F	OR6.4X0.9N	SRM4X4TL360	P-2
PDJNR/L**15-CHP	CU-D-CHP	SRM3	T-8F	OR6.4X0.9N	SRM4X4TL360	P-2

INSERT SELECTION

Application	Precision finishing	Finishing	Medium cutting	Medium to heavy cutting
	Grade	NS9530	GT9530	T9215
Chipbreaker shape	TF	TSF	TM	TH
Cutting conditions	B004			

Application	Finishing	Medium cutting	Medium to heavy cutting
	Grade	T6215	AH6225
Chipbreaker shape	SF	SM	SH
Cutting conditions	B006		

Application	Finishing	Medium cutting	Medium to heavy cutting
	Grade	T515	T515
Chipbreaker shape	All-round	All-round	All-round
Cutting conditions	B008		

Application	Precision finishing	Finishing	Medium cutting
	Grade	DX120	DX140
Chipbreaker shape	DIA	DIA with rake	P
Cutting conditions	B010		

Application	Precision finishing	Finishing	Medium cutting
	Grade	BX470	AH8005
Chipbreaker shape	CBN	HRF	HRM
Cutting conditions	B012		

Application	Precision finishing	Finishing
	Grade	BXA10
Chipbreaker shape	CBN	CBN
Cutting conditions	B014	

Reference pages: PDJNR/L-CHP: Inserts → **B066 - , B075 -**, CBN → **B172 - , B176 -**,PCD → **B211**
Parts for coolant hose → **C115**

Grade
Insert
Ext. Toolholder
Int. Toolholder
Threading
Grooving
Miniature tool
Milling cutter
Endmill
Drilling tool
Tooling System
User's Guide
Index



ADJNR/L-CHP-MC

Direct connection

Tube connection

Double clamping tool holders-93° approach angle

For negative 55°/45° rhombic insert. High-pressure coolant capability with tube and direct connections

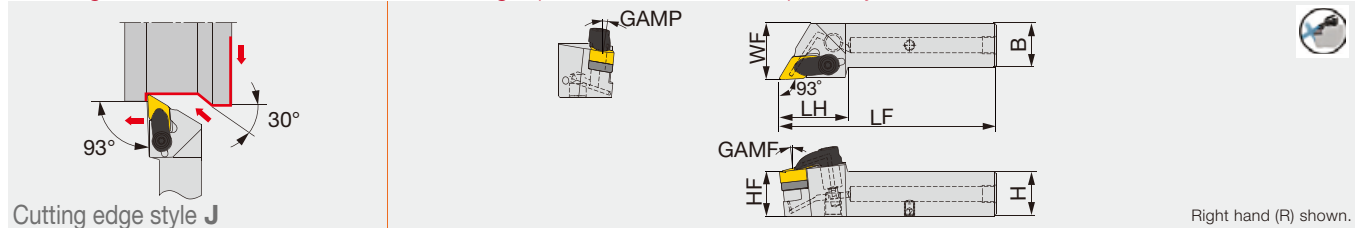

Cutting edge style J

Right hand (R) shown.

Designation	H	B	LF	LH	HF	WF	GAMP	GAMF	Insert	Torque*
ADJNR/L2020X-15-CHP-MC	20	20	110	40	20	25	6°	6°	DN**/FNGA1506...	4
ADJNR/L2525X-15-CHP-MC	25	25	125	40	25	32	6°	6°	DN**/FNGA1506...	4

*Torque: Recommended torque (N-m) for clamping
 Used shim RDT443, in case using insert DN1504...

Applicable for 14 MPa pressure coolant

SPARE PARTS

Designation	Clamp set	Shim	Shim screw	screw for tube connection	Coolant plug	O-ring	Wrench 1
ADJNL**X-15-CHP-MC	LCGL-4JCSET	RDT433	SR14-506	PLUGG1/8-6.5TL360	SRM5X5 DIN913TL360	OR4X3NBR70	KEYV-T20
ADJNR**X-15-CHP-MC	LCGR-4JCSET	RDT433	SR14-506	PLUGG1/8-6.5TL360	SRM5X5 DIN913TL360	OR4X3NBR70	KEYV-T20

TUNGCAP

C-PDJNR/L

Lever-lock toolholder, with 93° approach angle, for negative 55°/45° rhombic inserts

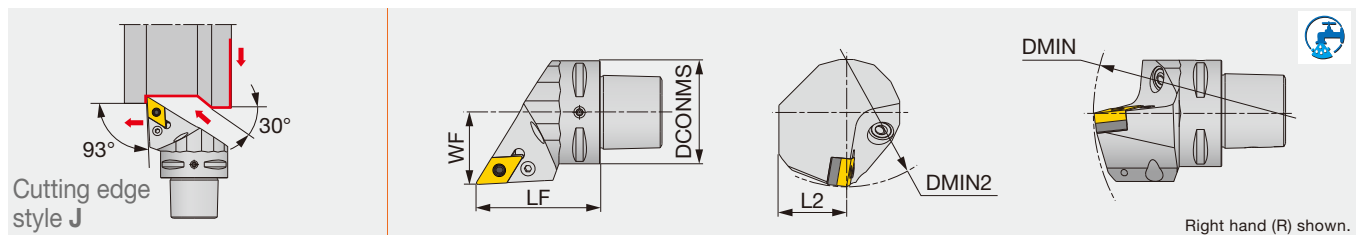

Cutting edge style J

Right hand (R) shown.

Designation	DCONMS	LF	L2	WF	DMIN	DMIN2	RE	Insert
C5PDJNR/L35060-15N	50	60	32	35	165	110	0.8	DN**/FNGA1504(06)...
C6PDJNR/L45065-15N	63	65	41	45	195	95	0.8	DN**/FNGA1504(06)...

Applicable for 7 MPa coolant

SPARE PARTS

Designation	Coolant parts	Shim	Lever	Clamping screw	Spring pin	Wrench
C5PDJN*35060-15N	SATZ-M10X1-M5	LSD43A	LCL4	LCS4	LSP4	P-3
C6PDJN*45065-15N	SATZ-M10X1-M5	LSD43A	LCL4	LCS4	LSP4S	P-3

Option: LSD42A (Shim for DN**1506**), LSP4S (Spring pin for DN**1506**)

Reference pages: ADJNR/L-CHP-MC: Inserts → **B066 - , B075 - ,** CBN → **B172 - , B176 - ,**PCD → **B211**

C-PDJNR/L: Inserts → **B066 - , B075 - ,** CBN → **B172 - , B176 - ,**PCD → **B211**

Parts for coolant hose → **C115**

Lever lock toolholders with TungCap connection – 93° approach angle.
For negative 55°/45° rhombic insert. High-pressure coolant capability.

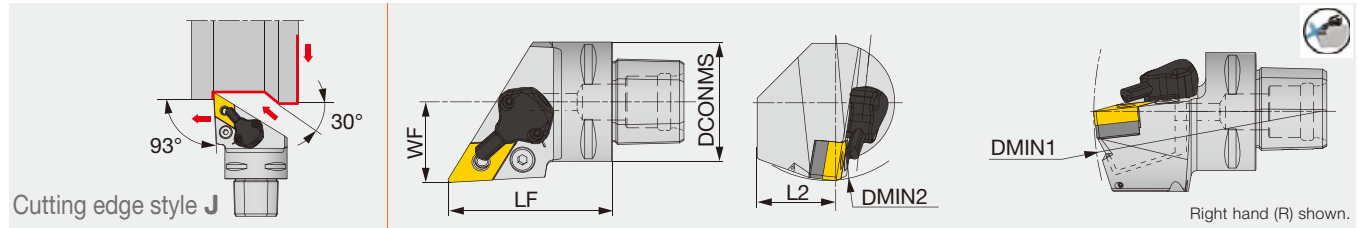

Designation	DCONMS	LF	L2	WF	DMIN1	DMIN2	RE**	Insert	Torque*
C4PDJNR/L27055-1104-CHP	40	55	27	27	145	110	0.8	DN**/FNMG1104...	2
C4PDJNR/L27055-15-CHP	40	55	27	27	145	110	0.8	DN**/FNGA1504(06)...	3
C5PDJNR/L35060-15-CHP	50	60	32	35	165	110	0.8	DN**/FNGA1504(06)...	3
C6PDJNR/L45065-1104-CHP	63	65	35	45	195	95	0.8	DN**/FNMG1104...	2
C6PDJNR/L45065-15-CHP	63	65	35	45	195	95	0.8	DN**/FNGA1504(06)...	3

*Torque: Recommended torque (N-m) for clamping
Applicable for 14 MPa pressure coolant
**RE: Standard corner radius

SPARE PARTS

Designation	Shim	Clamping screw	Wrench 1	Spring pin	Lever
C*PDJNR/L**1104-CHP	ELSD32	LCS3	P-2.5	LSP3	LCL33L
C*PDJNR/L**-15-CHP	LSD43A	LCS4	P-3	LSP4	LCL4

Option: LSD42A (Shim for DN**1506...), LSP4S (Spring pin for DN**1506...)

SPARE PARTS

Designation	Coolant unit	Mounting screw	Wrench 2	O-ring
C*PDJNR/L**1104-CHP	CU-D-CHP	SRM3	T-8F	OR6.4X0.9N
C*PDJNR/L**-15-CHP	CU-D-CHP	SRM3	T-8F	OR6.4X0.9N

INSERT SELECTION

Application	Precision finishing	Finishing	Medium cutting	Medium to heavy cutting
	Grade	NS9530	GT9530	T9215
Chipbreaker shape	TF	TSF	TM	TH
Cutting conditions	B004			

Application	Finishing	Medium cutting	Medium to heavy cutting
	Grade	T6215	AH6225
Chipbreaker shape	SF	SM	SH
Cutting conditions	B006		

Application	Finishing	Medium cutting	Medium to heavy cutting
	Grade	T515	T515
Chipbreaker shape	All-round	All-round	All-round
Cutting conditions	B008		

Application	Precision finishing	Finishing	Medium cutting
	Grade	DX120	DX140
Chipbreaker shape	DIA	with rake DIA	P
Cutting conditions	B010		

Application	Precision finishing	Finishing	Medium cutting
	Grade	BX470	AH8005
Chipbreaker shape	CBN	HRF	HRM
Cutting conditions	B012		

Application	Precision finishing	Finishing
	Grade	BXA10
Chipbreaker shape	CBN	CBN
Cutting conditions	B014	

Reference pages: PDJNR/L-CHP: Inserts → **B066 - , B075 -**, CBN → **B172 - , B176 -**,PCD → **B211**
Parts for coolant hose → **C115**



Double-clamp toolholder with 93° approach angle, for negative 55° rhombic ceramic inserts with dimple

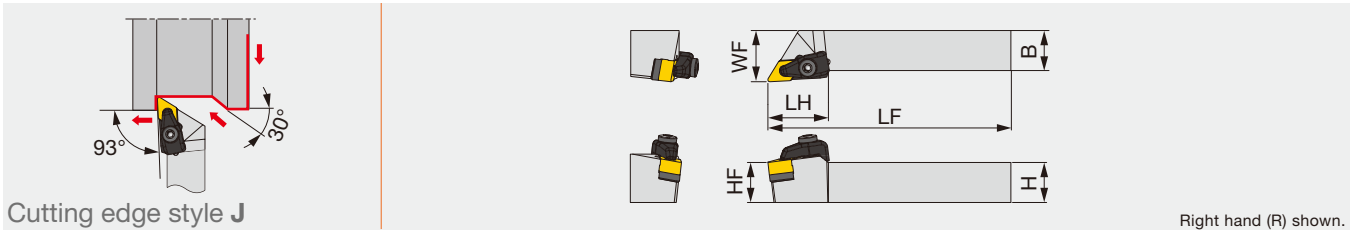

Right hand (R) shown.

Designation	H	B	LF	LH	HF	WF	RE**	Insert	Torque*
CDJNR/L2525M1507-RD	25	25	150	38	25	32	1.2	DN*D1507...	4
CDJNR3225P1507-RD	32	25	170	38	32	32	1.2	DN*D1507...	4

*Torque: Recommended clamping torque (N·m)

**RE: Standard corner radius

SPARE PARTS

Designation	Clamp	Clamp screw	Shim	Shim screw	Spring	Wrench1	Wrench2
CDJNR/L*-RD	CCP4-A	CCS4-A	CD44-A	BH5-10-A	BP-5-A	P-3	P-4

INSERT SELECTION

K	Application	Finishing to medium cutting
	Grade	FX105
	Chipbreaker shape	
	Cutting conditions	C118

Reference pages: CDJNR/L-RD: Inserts → **B074**

Standard cutting conditions → **C118**

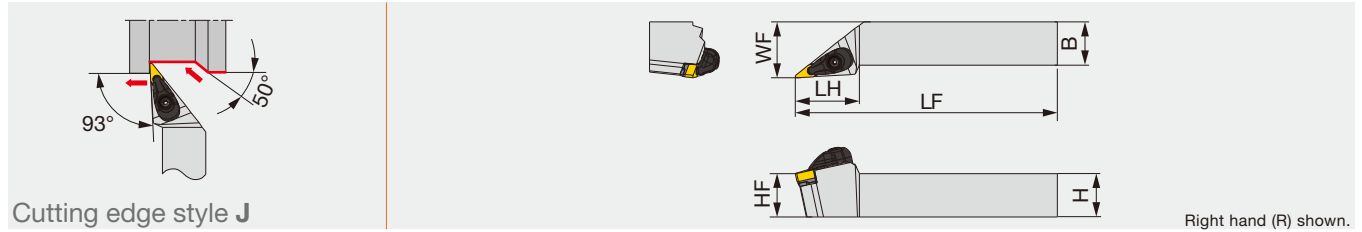

Right hand (R) shown.

Designation	H	B	LF	LH	HF	WF	RE**	Insert	Torque*
AVJNR/L2020K1204-A	20	20	125	37	20	25	0.8	VN**1204...	3
AVJNR/L2020K16-A	20	20	125	43	20	25	0.8	VN**/YN**1604...	3
AVJNR/L2525M1204-A	25	25	150	37	25	32	0.8	VN**1204...	3
AVJNR/L2525M16-A	25	25	150	46	25	32	0.8	VN**/YN**1604...	3

*Torque: Recommended clamping torque (N-m) **RE: Standard corner radius

SPARE PARTS

Designation	Clamp	Clamp screw	Spring	Spring pin	Shim	Shim screw	Wrench
AVJNR/L**1204-A	ACP3L-E	ACS-5W	BP-7	SP-2.5	ASV222	CSTB-3.0	T-15F
AVJNR/L**16-A	ACP3L	ACS-5W	BP-7	SP-2.5	ASV322	CSTB-3.5	T-15F

INSERT SELECTION

P	Application	Precision finishing	Finishing	Medium cutting	M	Application	Finishing	Medium cutting
	Grade	NS9530	GT9530	T9215		Grade	T6215	AH6225
	Chipbreaker shape	TF	TSF	TM		Chipbreaker shape	SF	SM
	Cutting conditions	B004				Cutting conditions	B006	
K	Application	Finishing	Medium cutting	Medium to heavy cutting	N	Application	Precision finishing	
	Grade	T515	T515	T515		Grade	DX120	
	Chipbreaker shape	All-round	All-round	All-round		Chipbreaker shape	DIA	with rake
	Cutting conditions	B008				Cutting conditions	B010	
S	Application	Precision finishing	Finishing	Medium cutting	H	Application	Precision finishing	Finishing
	Grade	BX470	AH8005	AH8005		Grade	BXA10	BXA20
	Chipbreaker shape	CBN	HRF	HRM		Chipbreaker shape	CBN	CBN
	Cutting conditions	B012				Cutting conditions	B014	

Reference pages: AVJNR/L: Inserts → **B098 -**, **B110**, CBN → **B186 -**, PCD → **B188**
Parts for coolant hose → **C115**



Double-clamp toolholder, with 93° approach angle, for negative 35° rhombic inserts (TurningA)

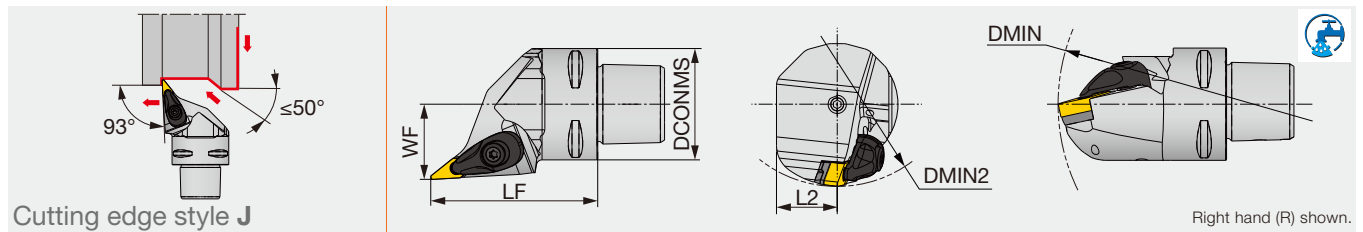

Designation	DCONMS	LF	L2	WF	DMIN	DMIN2	RE**	Insert
C4AVJNR/L27060-1204N	40	60	20	27	140	55	0.8	VN**1204...
C6AVJNR/L45065-1204N	63	65	31.5	45	190	81	0.8	VN**1204...

**RE: The holder measurements are true with this insert radius
Applicable for 7 MPa coolant

Designation	Clamp	Clamp screw	Coolant parts	Shim	Shim screw	Spring	Spring pin	Wrench 1	Wrench 2
C4AVJNR/L...	ACP3L-E	ACS-5W	-	ASV222	CSTB-3	BP-7	SP-2.5	T-9F	T-15F
C6AVJNR/L...	ACP3L-E	ACS-5W	SATZ-M10X1-M5	ASV222	CSTB-3	BP-7	SP-2.5	T-9F	T-15F

ISO ETURN PVJNR/L-Eco

Lever-lock toolholder with 93° approach angle, for negative 35° rhombic inserts

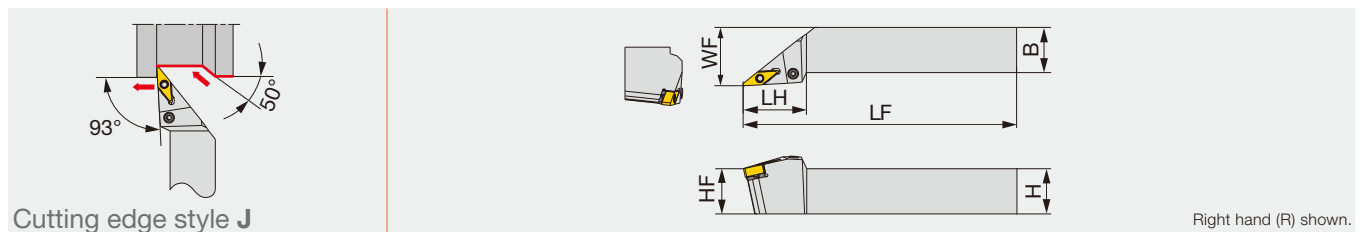

Designation	H	B	LF	LH	HF	WF	RE**	Insert	Torque*
PVJNR/L1616H1204	16	16	100	35	16	20	0.8	VN**1204...	2
PVJNR/L2020K1204	20	20	125	35	20	25	0.8	VN**1204...	2
PVJNR/L2525M1204	25	25	150	35	25	32	0.8	VN**1204...	2

*Torque: Recommended torque (N-m) for clamping

**RE: The holder measurements are true with this insert radius

Designation	Shim	Clamping screw	Wrench	Spring pin	Lever
PVJNR/L**1204	LSV212	LCS3V	P-2.5	LSP3	LCL3V

Reference pages: AVJNR/L: Inserts → **B098 -**, Parts for coolant hose → **C115**
PVJNR/L-Eco: Inserts → **B098 -**

PVJNR/L-CHP

Tube connection

Lever lock toolholders – 93° approach angle.
For negative 35°/25° rhombic insert. High-pressure coolant capability.

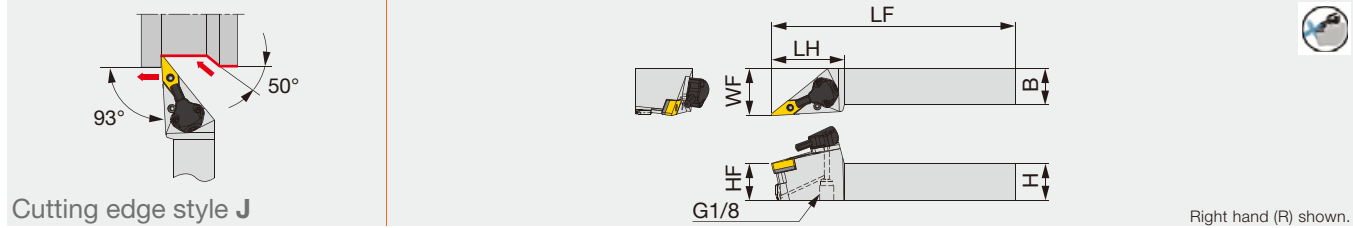

Designation	H	B	LF	LH	HF	WF	RE**	Insert	Torque*
PVJNR/L2020K1204-CHP	20	20	125	50	20	32	0.8	VN**1204...	2
PVJNR/L2020K16-CHP	20	20	125	50	20	32	0.8	VN**/YN**1604...	2
PVJNR/L2525M1204-CHP	25	25	150	50	25	32	0.8	VN**1204...	2
PVJNR/L2525M16-CHP	25	25	150	50	25	32	0.8	VN**/YN**1604...	2

*Torque: Recommended torque (N·m) for clamping
**RE: Standard corner radius

SPARE PARTS

Designation	Shim	Clamping screw	Wrench 1	Spring pin	Lever
PVJNR/L**1204-CHP	LSV212	LCS3V	P-2.5	LSP3	LCL3V
PVJNR/L**16-CHP	LSV317	LCS3V	P-2.5	LSP3	LCL3V

SPARE PARTS

Designation	Coolant unit	Mounting screw	Wrench 2	O-ring	Coolant screw	Wrench 3
PVJNR/L**1204-CHP	CU-V-CHP	SRM3	T-8F	OR6.4X0.9N	SRM4X4TL360	P-2
PVJNR/L**16-CHP	CU-V-CHP	SRM3	T-8F	OR6.4X0.9N	SRM4X4TL360	P-2

INSERT SELECTION

Application	Precision finishing	Finishing	Medium cutting
	Grade	NS9530	GT9530
Chipbreaker shape	TF	TSF	TM
Cutting conditions	B004		

Application	Finishing	Medium cutting
	Grade	T6215
Chipbreaker shape	SF	SM
Cutting conditions	B006	

Application	Finishing	Medium cutting	Medium to heavy cutting
	Grade	T515	T515
Chipbreaker shape	All-round	All-round	All-round
Cutting conditions	B008		

Application	Precision finishing
	Grade
Chipbreaker shape	DIA with rake
Cutting conditions	B010

Application	Precision finishing	Finishing	Medium cutting
	Grade	BX470	AH8005
Chipbreaker shape	CBN	HRF	HRM
Cutting conditions	B012		

Application	Precision finishing	Finishing
	Grade	BXA10
Chipbreaker shape	CBN	CBN
Cutting conditions	B014	

Reference pages: PVJNR/L-CHP: Inserts → B098 -, B110, CBN → B186 -, PCD → B188
Parts for coolant hose → C115

Grade
Insert
Ext. Toolholder
Int. Toolholder
Threading
Grooving
Miniature tool
Milling cutter
Endmill
Drilling tool
Tooling System
User's Guide
Index



Lever lock toolholders with TungCap connection – 93° approach angle.
For negative 35°/25° rhombic insert. High-pressure coolant capability.

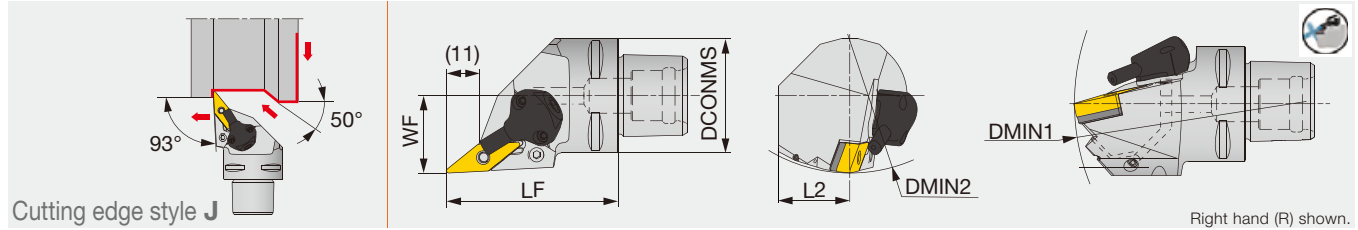

Designation	DCONMS	LF	L2	WF	DMIN1	DMIN2	RE**	Insert	Torque*
C4PVJNR/L27060-1204-CHP	40	60	20	27	140	90	0.8	VN**1204...	2
C4PVJNR/L27060-16-CHP	40	60	20	27	140	110	0.8	VN**/YN**1604...	2
C6PVJNR/L45065-1204-CHP	63	65	31.5	45	190	81	0.8	VN**1204...	2
C6PVJNR/L45065-16-CHP	63	65	31.5	45	190	81	0.8	VN**/YN**1604...	2

*Torque: Recommended torque (N·m) for clamping
Applicable for 14 MPa pressure coolant
**RE: Standard corner radius

Designation	Shim	Clamping screw	Wrench 1	Spring pin	Lever
C*PVJNR/L*-1204-CHP	LSV212	LCS3V	P-2.5	LSP3	LCL3V
C*PVJNR/L...16-CHP	LSV317	LCS3V	P-2.5	LSP3	LCL3V

Designation	Coolant unit	Mounting screw	Wrench 2	O-ring
C*PVJNR/L*-1204-CHP	CU-V-CHP	SRM3	T-8F	OR6.4X0.9N
C*PVJNR/L...16-CHP	CU-V-CHP	SRM3	T-8F	OR6.4X0.9N

INSERT SELECTION

Application	Precision finishing	Finishing	Medium cutting
	Grade	NS9530	GT9530
Chipbreaker shape	TF	TSF	TM
Cutting conditions	B004		

Application	Finishing	Medium cutting
	Grade	T6215
Chipbreaker shape	SF	SM
Cutting conditions	B006	

Application	Finishing	Medium cutting	Medium to heavy cutting
	Grade	T515	T515
Chipbreaker shape	All-round	All-round	All-round
Cutting conditions	B008		

Application	Precision finishing
Grade	DX120
Chipbreaker shape	DIA with rake
Cutting conditions	B010

Application	Precision finishing	Finishing	Medium cutting
	Grade	BX470	AH8005
Chipbreaker shape	CBN	HRF	HRM
Cutting conditions	B012		

Application	Precision finishing	Finishing
	Grade	BXA10
Chipbreaker shape	CBN	CBN
Cutting conditions	B014	

Reference pages: C-PVJNR/L-CHP: Inserts → **B098 -**, **B110**, CBN → **B186 -**, PCD → **B188**
Parts for coolant hose → **C115**

Screw-on toolholder with 93° approach angle, for DXGU inserts

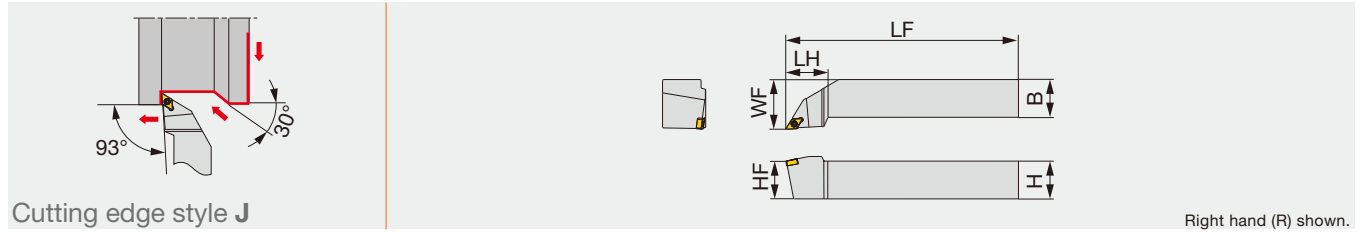

Designation	H	B	LF	LH	HF	WF	RE**	Insert	Torque*
JSDJXR/L2020K07	20	20	125	27	20	25	0.4	DXGU0703**L/R...	0.9
JSDJXR/L2525M07	25	25	150	27	25	32	0.4	DXGU0703**L/R...	0.9

*Torque: Recommended clamping torque (N·m) **RE: Standard corner radius
 Note: Use right-hand toolholders (R) with left-hand inserts (L); and left-hand toolholders (L) with right-hand inserts (R).

JSDJ2XR/L

Screw-on toolholder with 93° approach angle, for DXGU inserts

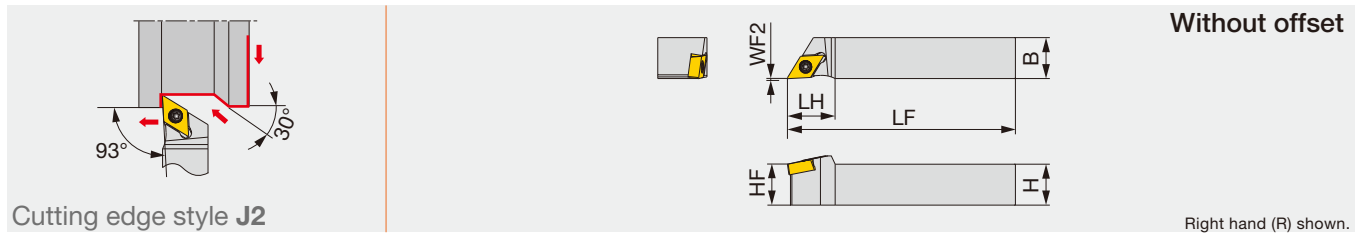

Designation	H	B	LF	LH	HF	WF2	RE**	Insert	Torque*
JSDJ2XR/L1010X07	10	10	120	14	10	0	0.2	DXGU0703**L/R...	0.9
JSDJ2XR/L1212F07	12	12	85	14	12	0	0.2	DXGU0703**L/R...	0.9
JSDJ2XR/L1212X07	12	12	120	14	12	0	0.2	DXGU0703**L/R...	0.9
JSDJ2XR/L1616X07	16	16	120	18	16	0	0.2	DXGU0703**L/R...	0.9
JSDJ2XR/L2020H07	20	20	100	18	20	0	0.2	DXGU0703**L/R...	0.9

*Torque: Recommended clamping torque (N·m) **RE: Standard corner radius
 Note: Use right-hand toolholders (R) with left-hand inserts (L); and left-hand toolholders (L) with right-hand inserts (R).

SPARE PARTS

Designation	Clamping screw	Wrench
JSDJXR/L...	SR34-514	T-7F
JSDJ2XR/L...		

INSERT SELECTION

Swiss lathes

Application	Finishing		Medium cutting	
	SH725	AH725	SH725	AH725
Grade	JSS	JTS	JSS	JTS
Chipbreaker shape				
Cutting conditions	C118			

Small CNC lathes

Application	Finishing		Medium cutting	
	AH725	AH725	AH8015	AH8015
Grade	SS	TS	SS	TS
Chipbreaker shape				
Cutting conditions	C118			

Reference pages: JSDJXR/L, JSDJ2XR/L: Inserts → **B128** -
 Standard cutting conditions → **C118**

SDJCR/L

Screw-on toolholder with 93° approach angle, for positive 55° rhombic inserts

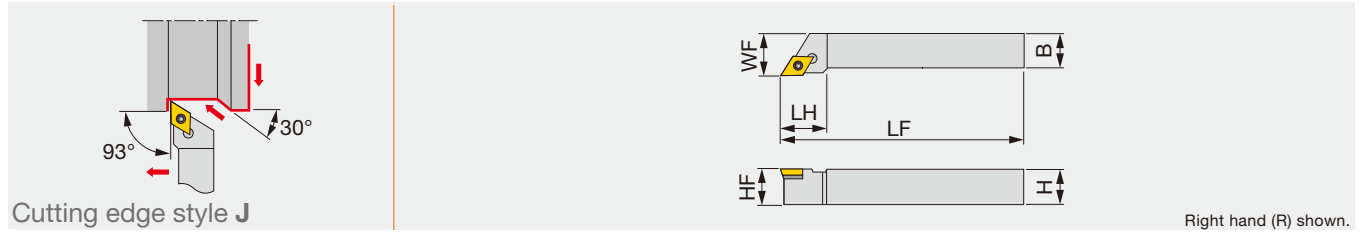

Designation	H	B	LF	LH	HF	WF	RE**	Insert
SDJCR1616H11	16	16	100	20	16	20	0.8	DC**11T3...
SDJCR/L2020K11	20	20	125	20.5	20	25	0.8	DC**11T3...
SDJCR/L2525M11	25	25	150	21.5	25	32	0.8	DC**11T3...

**RE: Standard corner radius

SPARE PARTS

Designation	Clamping screw	Shim screw	Shim	Wrench1	Wrench2
SDJCR/L...	CSTB-3.5L	DTS5-3.5	SSD32	P-3.5	T-15F

TUNGCAP

C-SDJCR/L-CHP

Screw-on toolholder, with 93° approach angle, for positive 55° rhombic inserts, with high pressure coolant capability

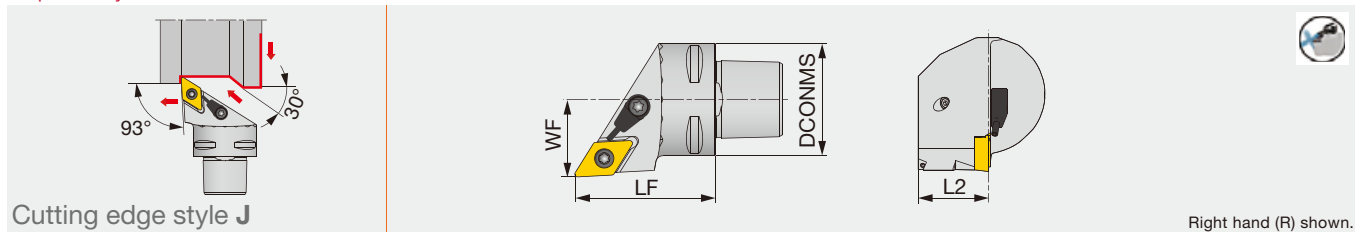

Designation	DCONMS	LF	L2	WF	RE	Insert
C3SDJCR/L22040-11-CHP	32	40	20	22	0.8	DC**11T3...

Applicable for 14 MPa coolant
Cannot be used for boring

SPARE PARTS

Designation	Clamping screw	Coolant unit	Wrench
C3SDJCR/L22040-11-CHP	CSTB-4S	S-CU-CHP	T-15F

INSERT SELECTION

Application	Finishing	Finishing to medium cutting	Medium cutting
	Grade	NS9530	T9215
Chipbreaker shape	PSS	PS	PM
Cutting conditions	B016		

Application	Precision finishing	Finishing	Finishing to medium cutting	Medium cutting
	Grade	GH330	AH6225	AH6225
Chipbreaker shape	W**	PSS	PS	PM
Cutting conditions	B018			

Application	Finishing to medium cutting
	Grade
Chipbreaker shape	CM
Cutting conditions	B020

Application	Precision finishing	Finishing	Medium cutting
	Grade	DX120	DX140
Chipbreaker shape	DIA	DIA with rake	AL
Cutting conditions	B022		

Application	Finishing	Finishing to medium cutting
	Grade	AH8015
Chipbreaker shape	PSS	PS
Cutting conditions	B024	

Application	Precision finishing	Finishing
	Grade	BXA10
Chipbreaker shape	CBN	CBN
Cutting conditions	B026	

Reference pages: SDJCR/L: Inserts → B121 -, CBN → B194, PCD → B214

C-SDJCR/L-CHP: Inserts → B121 -, CBN → B194, PCD → B214, Parts for coolant hose → C115

Screw-on toolholder with 93° approach angle, for VXGU inserts

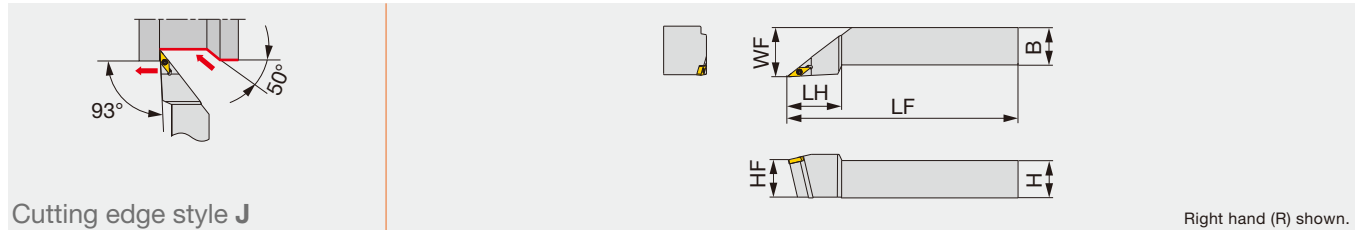

Cutting edge style J

Right hand (R) shown.

Designation	H	B	LF	LH	HF	WF	RE**	Insert	Torque*
JSVJXR/L2020K09	20	20	125	35	20	25	0.4	VXGU09T2**L/R...	0.9
JSVJXR/L2525M09	25	25	150	35	25	32	0.4	VXGU09T2**L/R...	0.9

*Torque: Recommended clamping torque (N·m) **RE: Standard corner radius

Note: Use right-hand toolholders (R) with left-hand inserts (L); and left-hand toolholders (L) with right-hand inserts (R).

JSVJ2XR/L

Screw-on toolholder with 93° approach angle, for VXGU inserts

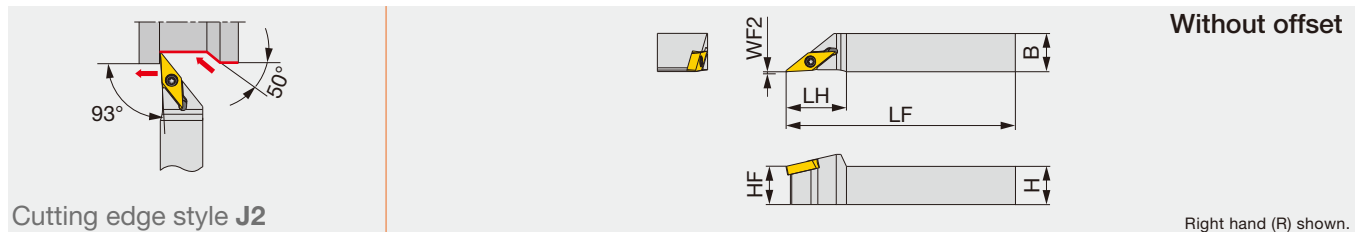

Cutting edge style J2

Without offset

Right hand (R) shown.

Designation	H	B	LF	LH	HF	WF2	RE**	Insert	Torque*
JSVJ2XR/L1010X09	10	10	120	17	10	0	0.2	VXGU09T2**L/R...	0.9
JSVJ2XR/L1212F09	12	12	85	19	12	0	0.2	VXGU09T2**L/R...	0.9
JSVJ2XR/L1212X09	12	12	120	19	12	0	0.2	VXGU09T2**L/R...	0.9
JSVJ2XR/L1616X09	16	16	120	19	16	0	0.2	VXGU09T2**L/R...	0.9
JSVJ2XR/L2020H09	20	20	100	19	20	0	0.2	VXGU09T2**L/R...	0.9

*Torque: Recommended clamping torque (N·m) **RE: Standard corner radius

Note: Use right-hand toolholders (R) with left-hand inserts (L); and left-hand toolholders (L) with right-hand inserts (R).

SPARE PARTS

Designation	Clamping screw	Wrench
JSVJXR/L...	SR34-508	T-7F
JSVJ2XR/L...		

INSERT SELECTION

P	Application	Finishing	M	Application	Finishing
	Grade	SH725		Grade	SH725
	Chipbreaker shape	JRP		Chipbreaker shape	JRP
	Cutting conditions	C118		Cutting conditions	C118

Reference pages: JSVJXR/L, JSVJ2XR/L: Inserts → B155

Standard cutting conditions → C118

SVJCR/L

Screw-on toolholder with 93° approach angle, for positive 35° rhombic inserts

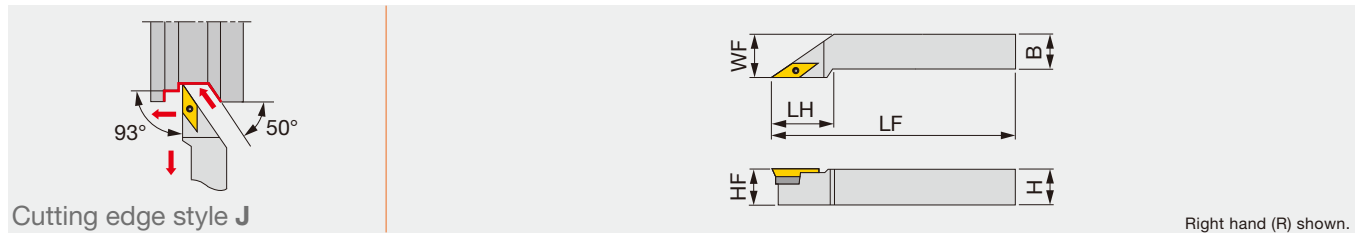

Cutting edge style J

Right hand (R) shown.

Designation	H	B	LF	LH	HF	WF	RE**	Insert
SVJCR/L1616H16	16	16	100	32	16	20	0.8	VC**1604...
SVJCR/L2020K16	20	20	125	32	20	25	0.8	VC**1604...
SVJCR/L2525M16	25	25	150	40	25	32	0.8	VC**1604...

**RE: Standard corner radius

TUNGCAP C-SVJCR/L

Screw-on toolholder, with 93° approach angle, for positive 35° rhombic inserts

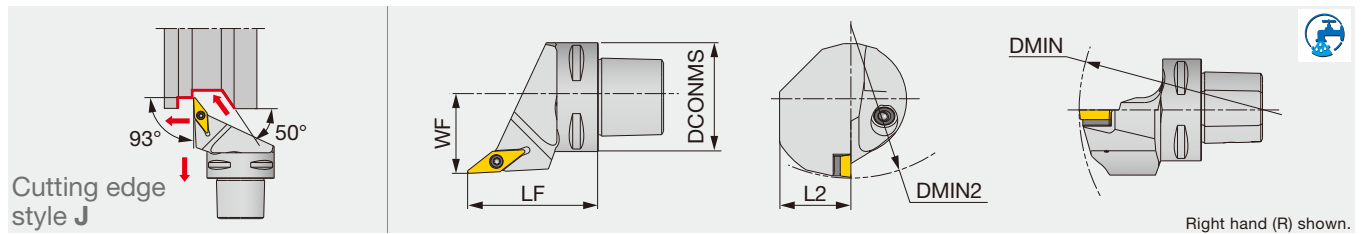

Cutting edge style J

Right hand (R) shown.

Designation	DCONMS	LF	L2	WF	DMIN	DMIN2	RE	Insert
C3SVJCR/L22040-11N ⁽²⁾	32	40	20	22	-	-	0.4	VC**1103...
C5SVJCL35060-16 ⁽¹⁾	50	60	32	35	-	-	0.8	VC**1604...
C5SVJCR/L35060-16N ⁽²⁾	50	60	32	35	170	160	0.8	VC**1604...
C6SVJCR/L45065-16 ⁽¹⁾	63	65	41	45	-	-	0.8	VC**1604...
C6SVJCR/L45065-16N ⁽²⁾	63	65	41	45	170	190	0.8	VC**1604...

The items without DMIN and DMIN2 cannot be used for boring.
(1) Applicable for 3 MPa coolant (2) Applicable for 7 MPa coolant

SPARE PARTS

Designation	Clamping screw	Coolant parts	Shim	Shim screw	Wrench 1	Wrench 2
SVJCR/L...	CSTB-3.5L	-	SSV32	DTS5-3.5	P-3.5	T-15F
C3SVJC*22040-11N	CSTB-2.5	SATZ-M8X1-M3	-	-	-	T-8F
C5SVJC*35060-16	CSTB-3.5L	EZ104	SSV32	DTS5-3.5	P-3.5	T-15F
C5SVJC*35060-16N	CSTB-3.5L	SATZ-M10X1-M5	SSV32	DTS5-3.5	P-3.5	T-15F
C6SVJC*45065-16	CSTB-3.5L	EZ104	SSV32	DTS5-3.5	P-3.5	T-15F
C6SVJC*45065-16N	CSTB-3.5L	SATZ-M10X1-M5	SSV32	DTS5-3.5	P-3.5	T-15F

Reference pages: SVJCR/L, C-SVJCR/L: Inserts → **B152 -**, CBN → **B209**, PCD → **B220**

INSERT SELECTION

P	Application	Finishing	Finishing to medium cutting	M	Application	Finishing	Finishing to medium cutting
	Grade	NS9530	T9215		Grade	AH6225	AH6225
	Chipbreaker shape	PSS	PS		Chipbreaker shape	PSS	PS
	Cutting conditions	B016			Cutting conditions	B018	

K	Application	Finishing to medium cutting	N	Application	Precision finishing	Finishing	Medium cutting
	Grade	T515		Grade	DX120	DX140	KS05F
	Chipbreaker shape	CM		Chipbreaker shape	DIA	with rake DIA	AL
	Cutting conditions	B020		Cutting conditions	B022		

S	Application	Finishing	Finishing to medium cutting	H	Application	Precision finishing	Finishing
	Grade	AH8015	AH8015		Grade	BXA10	BXA20
	Chipbreaker shape	PSS	PS		Chipbreaker shape	CBN	CBN
	Cutting conditions	B024			Cutting conditions	B026	

Y-PRO SERIES SYJBR/L

Screw-on toolholder with 93° approach angle, for positive 25° rhombic inserts

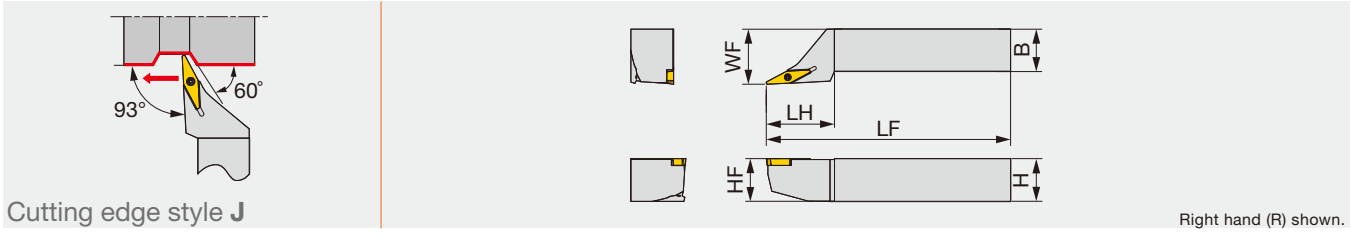

Designation	H	B	LF	LH	HF	WF	RE**	Insert
SYJBR/L2020K16	20	20	125	35	20	25	0.8	YWMT16T3...
SYJBR/L2525M16	25	25	150	40	25	32	0.8	YWMT16T3...

**RE: Standard corner radius

SPARE PARTS

Designation	Clamping screw	Wrench
SYJBR/L...	CSTB-2.5L080	T-8F

INSERT SELECTION

P	Application	Finishing to medium cutting	M	Application	Finishing to medium cutting	K	Application	Finishing to medium cutting	S	Application	Finishing to medium cutting
	Grade	T9225		Grade	AH8015		Grade	GT9530		Grade	AH8015
	Breaker Shape	ZM		Breaker Shape	ZM		Breaker Shape	ZM		Breaker Shape	ZM
	Cutting conditions	B016		Cutting conditions	B018		Cutting conditions	B020		Cutting conditions	B024

Reference pages: SYJBR/L: Inserts → **B159**

Double-clamp toolholder with 72.5° approach angle, for negative 35°/25° rhombic inserts

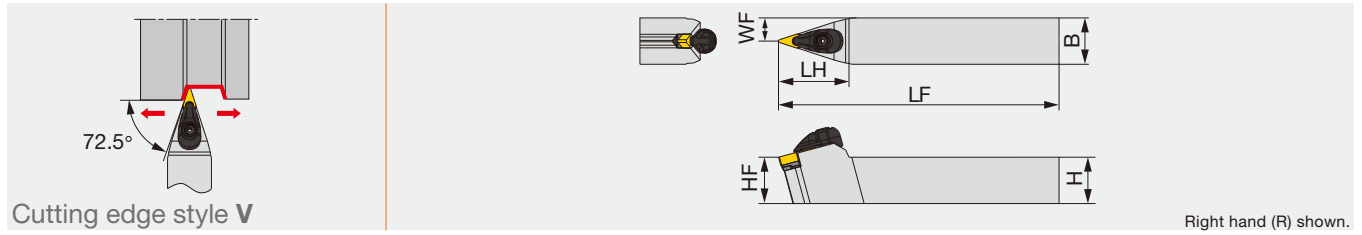

Designation	H	B	LF	LH	HF	WF	RE**	Insert	Torque*
AVVNN2020K1204-A	20	20	125	38	20	10	0.8	VN**1204...	3
AVVNN2020K16-A	20	20	125	46	20	10	0.8	VN**/YN**1604...	3
AVVNN2525M1204-A	25	25	150	38	25	13	0.8	VN**1204...	3
AVVNN2525M16-A	25	25	150	46	25	12.5	0.8	VN**/YN**1604...	3

*Torque: Recommended clamping torque (N-m) **RE: Standard corner radius

Designation	Clamp	Clamp screw	Spring	Spring pin	Shim	Shim screw	Wrench
AVVNN**1204-A	ACP3L-E	ACS-5W	BP-7	SP-2.5	ASV222	CSTB-3.0	T-15F
AVVNN**16-A	ACP3L	ACS-5W	BP-7	SP-2.5	ASV322	CSTB-3.5	T-15F

ISO ETURN

PVVNN-Eco

Lever-lock toolholder with 72.5° approach angle, for negative 35° rhombic inserts

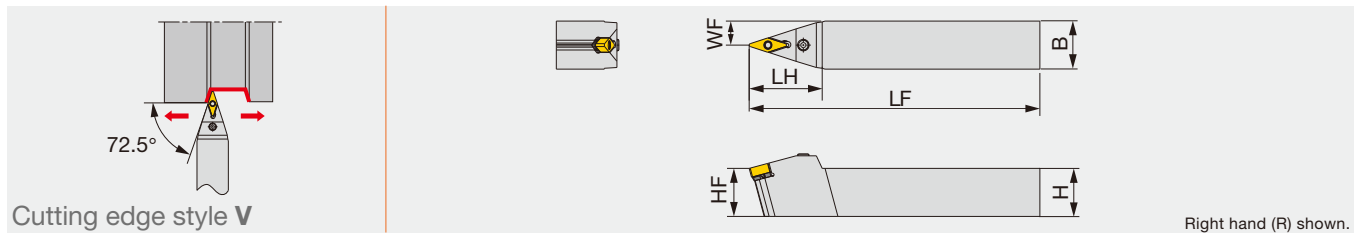

Designation	H	B	LF	LH	HF	WF	RE**	Insert	Torque*
PVVNN2020K1204	20	20	125	38	20	10	0.8	VN**1204...	2
PVVNN2525M1204	25	25	150	38	25	12.5	0.8	VN**1204...	2

*Torque: Recommended clamping torque (N-m) **RE: Standard corner radius

Designation	Shim	Clamping screw	Wrench	Spring pin	Lever
PVVNN**1204	LSV212	LCS3V	P-2.5	LSP3	LCL3V

INSERT SELECTION

P	Application	Precision finishing	Finishing	Medium cutting	M	Application	Finishing	Medium cutting
	Grade	NS9530	GT9530	T9215		Grade	T6215	AH6225
	Chipbreaker shape	TF	TSF	TM		Chipbreaker shape	SF	SM
	Cutting conditions	B004				Cutting conditions	B006	
K	Application	Finishing	Medium cutting	Medium to heavy cutting	N	Application	Precision finishing	
	Grade	T515	T515	T515		Grade	DX120	
	Chipbreaker shape	All-round	All-round	All-round		Chipbreaker shape	DIA with rake	
	Cutting conditions	B008				Cutting conditions	B010	
S	Application	Precision finishing	Finishing	Medium cutting	H	Application	Precision finishing	Finishing
	Grade	BX470	AH8005	AH8005		Grade	BXA10	BXA20
	Chipbreaker shape	CBN	HRF	HRM		Chipbreaker shape	CBN	CBN
	Cutting conditions	B012				Cutting conditions	B014	

Reference pages: AVVNN: Inserts → B098 -, B110, CBN → B186 -, PCD → B188
 PVVNN-Eco: Inserts → B098 -

Double-clamp toolholder with 72.5° approach angle, for negative 35° rhombic ceramic inserts with dimple

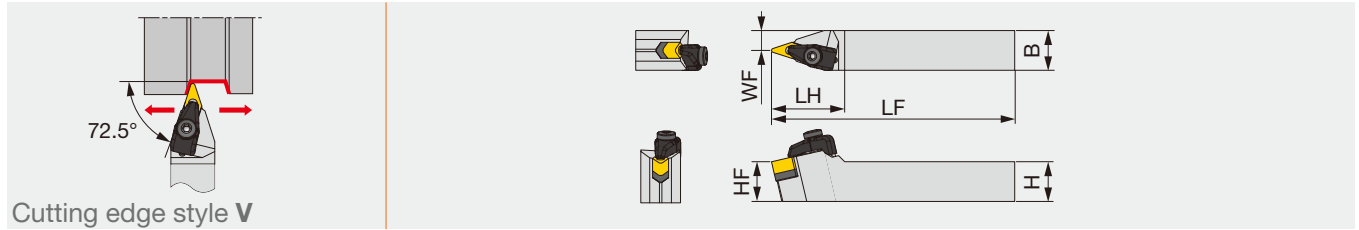

Designation	H	B	LF	LH	HF	WF	RE**	Insert	Torque*
CVVNN2525M1607-RD	25	25	150	46	25	12.5	1.2	VN*D160712	4

*Torque: Recommended clamping torque (N·m)
 **RE: Standard corner radius

SPARE PARTS

Designation	Clamp	Clamp screw	Shim	Shim screw	Spring	Wrench1	Wrench2
CVVNN2525M1607-RD	CCP4-A	CCS4-A	CV34-A	BH-4-10-A	BP-5-A	P-3	P-4

INSERT SELECTION

K	Application	Finishing to medium cutting
	Grade	FX105
	Chipbreaker shape	
	Cutting conditions	C118

Reference pages: CVVNN-RD: Inserts → **B101**
 Standard cutting conditions → **C118**



SVVCN

Screw-on toolholder with 72.5° approach angle, for positive 35° rhombic inserts

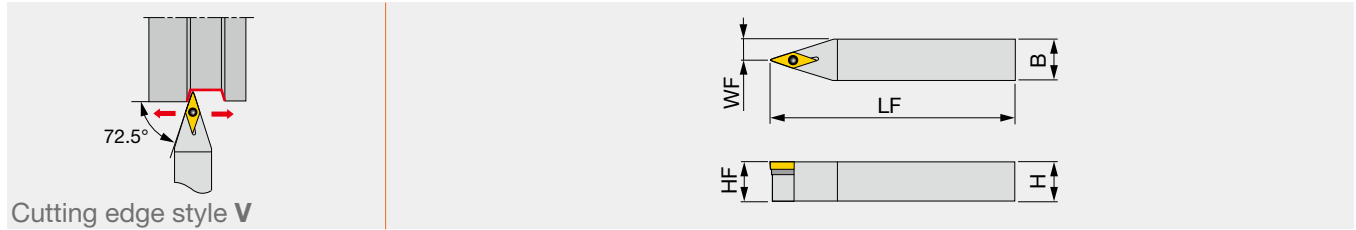

Designation	H	B	LF	HF	WF	RE**	Insert
SVVCN2020K16	20	20	125	20	10	0.8	VC**1604...
SVVCN2525M16	25	25	150	25	12.5	0.8	VC**1604...

**RE: Standard corner radius

SPARE PARTS

Designation	Clamping screw	Shim	Shim screw	Wrench 1	Wrench 2
SVVCN...	CSTB-3.5L	SSV32	DTS5-3.5	P-3.5	T-15F

TUNGCAP

C-SVVCN

Screw-on toolholder, with 72.5° approach angle, for positive 35° rhombic inserts

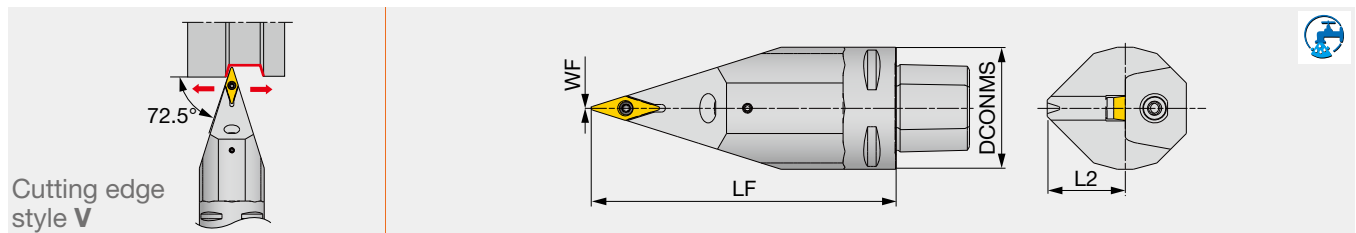

Designation	DCONMS	LF	L2	WF	RE	Insert
C5SVVCN00090-16 ⁽¹⁾	50	90	32	0	0.8	VC**1604...
C5SVVCN00090-16N ⁽²⁾	50	90	32	0	0.8	VC**1604...
C5SVVCN00125-16 ⁽¹⁾	50	125	32	0	0.8	VC**1604...
C5SVVCN00125-16N ⁽²⁾	50	125	32	0	0.8	VC**1604...
C6SVVCN00100-16N ⁽²⁾	63	100	37.5	0	0.8	VC**1604...
C6SVVCN00140-16N ⁽²⁾	63	140	37.5	0	0.8	VC**1604...

(1) Applicable for 3 MPa coolant (2) Applicable for 7 MPa coolant

SPARE PARTS

Designation	Clamping screw	Coolant parts	Shim	Shim screw	Wrench 1	Wrench 2
C5SVVCN00090-16	CSTB-3.5L	EZ104	SSV32	DTS5-3.5	P-3.5	T-15F
C5SVVCN00090-16N	CSTB-3.5L	SATZ-M10X1-M5	SSV32	DTS5-3.5	P-3.5	T-15F
C5SVVCN00125-16	CSTB-3.5L	EZ104	SSV32	DTS5-3.5	P-3.5	T-15F
C5SVVCN00125-16N	CSTB-3.5L	SATZ-M10X1-M5	SSV32	DTS5-3.5	P-3.5	T-15F
C6SVVCN00100-16N	CSTB-3.5L	SATZ-M10X1-M5	SSV32	DTS5-3.5	P-3.5	T-15F
C6SVVCN00140-16N	CSTB-3.5L	SATZ-M10X1-M5	SSV32	DTS5-3.5	P-3.5	T-15F

Reference pages: SVVCN, C-SVVCN: Inserts → **B152 -**, CBN → **B209**, PCD → **B220**

INSERT SELECTION

P	Application	Finishing	Finishing to medium cutting	M	Application	Finishing	Finishing to medium cutting	
	Grade	NS9530	T9215		Grade	AH6225	AH6225	
	Chipbreaker shape	PSS	PS		Chipbreaker shape	PSS	PS	
	Cutting conditions	B016			Cutting conditions	B018		
K	Application	Finishing to medium cutting		N	Application	Precision finishing	Finishing	Medium cutting
	Grade	T515			Grade	DX120	DX140	KS05F
	Chipbreaker shape	CM			Chipbreaker shape	DIA	with rake DIA	AL
	Cutting conditions	B020			Cutting conditions	B022		
S	Application	Finishing	Finishing to medium cutting	H	Application	Precision finishing	Finishing	
	Grade	AH8015	AH8015		Grade	BXA10	BXA20	
	Chipbreaker shape	PSS	PS		Chipbreaker shape	CBN	CBN	
	Cutting conditions	B024			Cutting conditions	B026		

Y-PRO SERIES SYIBN

Screw-on toolholder with 77.5° approach angle, for positive 25° rhombic inserts

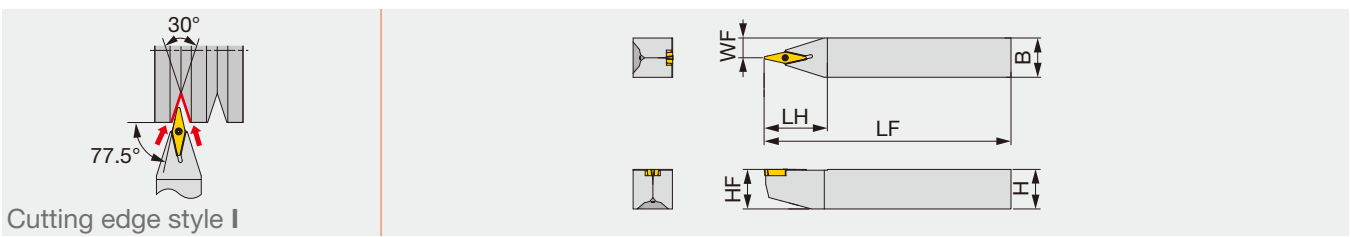

Designation	H	B	LF	LH	HF	WF	RE**	Insert
SYIBN2020K16	20	20	125	32	20	10	0.8	YWMT16T3...
SYIBN2525M16	25	25	150	40	25	12.5	0.8	YWMT16T3...

**RE : Standard corner radius

SPARE PARTS

Designation	Clamping screw	Wrench
SYIBN...	CSTB-2.5L080	T-8F

INSERT SELECTION

P	Application	Finishing to medium cutting	M	Application	Finishing to medium cutting	K	Application	Finishing to medium cutting	S	Application	Finishing to medium cutting
	Grade	T9225		Grade	AH8015		Grade	GT9530		Grade	AH8015
	Breaker Shape	ZM		Breaker Shape	ZM		Breaker Shape	ZM		Breaker Shape	ZM
	Cutting conditions	B016		Cutting conditions	B018		Cutting conditions	B020		Cutting conditions	B024

Reference pages: SYIBN: Inserts → **BB159**

STACR/L

Screw-on toolholder with 91° approach angle, for positive 60° triangular inserts

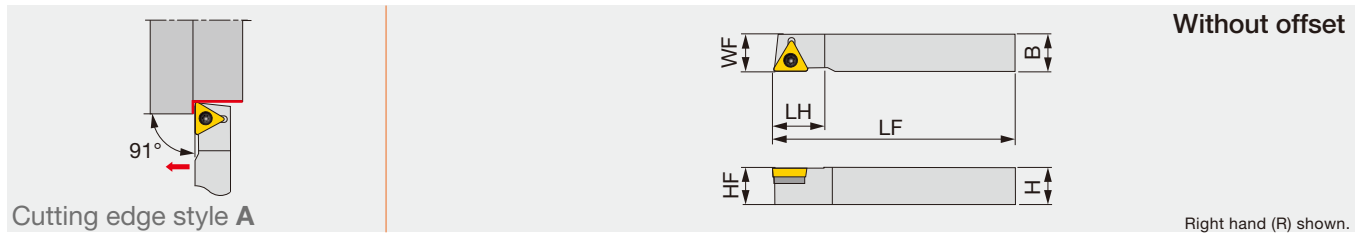

Designation	H	B	LF	LH	HF	WF	RE**	Insert
STACR/L1616H16	16	16	100	22.5	16	16	0.8	TC**16T3...

**RE: Standard corner radius

SPARE PARTS

Designation	Clamping screw	Shim screw	Shim	Wrench1	Wrench2
STACR/L...	CSTB-3.5L	DTS5-3.5	SST32	P-3.5	T-15F

INSERT SELECTION

P	Application	Finishing	Finishing to medium cutting	Medium cutting	M	Application	Finishing	Finishing to medium cutting	Medium cutting	
	Grade	T9215	T9215	T9215		Grade	AH725	AH6225	AH6225	
	Breaker Shape					Breaker Shape				
	Cutting conditions	B016				Cutting conditions	B018			
K	Application	Finishing to medium cutting	N	Application	Finishing to medium cutting	S	Application	Finishing	Finishing to medium cutting	Medium cutting
	Grade	T515		Grade	KS05F		Grade	AH725	AH6225	AH6225
	Breaker Shape			Breaker Shape			Breaker Shape			
	Cutting conditions	B020		Cutting conditions	B022		Cutting conditions	B024		

TURNTEC

TLANR/L

Screw-on toolholder for roughing with 93° approach angle, for negative tangential inserts

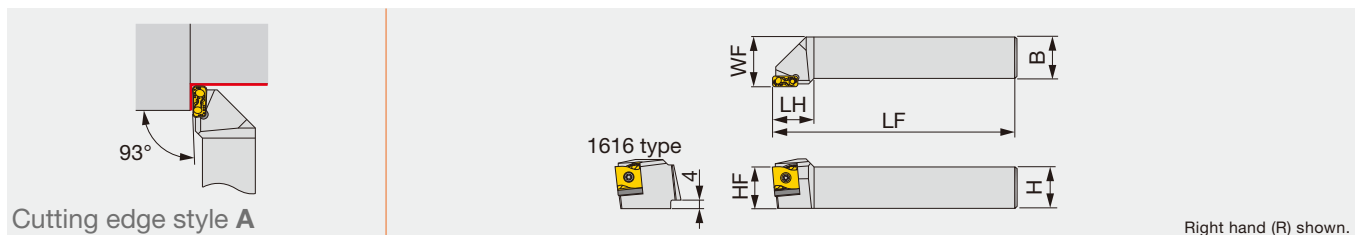

Designation	H	B	LF	LH	HF	WF	Insert
TLANR/L1616H12	16	16	100	20	16	20	LNMX1204**R/L...
TLANR/L1616M12S	16	16	150	20	16	20	LNMX1204**R/L...
TLANR/L2020K12	20	20	125	20	20	25	LNMX1204**R/L...
TLANR/L2020K16	20	20	125	25	20	25	LNMX1606**R/L...
TLANR/L2525M12	25	25	150	20	25	30	LNMX1204**R/L...
TLANR/L2525M16	25	25	150	25	25	30	LNMX1606**R/L...
TLANR/L3232P16	32	32	170	35	32	37	LNMX1606**R/L...
TLANR/L3232P24	32	32	170	35	32	38	LNMX2410**R/L...
TLANR/L4040R16	40	40	200	35	40	47	LNMX1606**R/L...
TLANR/L4040R24	40	40	200	40	40	47	LNMX2410**R/L...
TLANR/L5050S24	50	50	250	40	50	57	LNMX2410**R/L...

Reference pages: TLANR/L: Standard cutting conditions → C119

SPARE PARTS

Designation	Clamping screw	Shim screw	Shim	Spring	Wrench 1	Wrench 2
TLANR1616H12, TLANR1616M12S TLANR2020K12, TLANR2525M12	CSTB-3.5L115-S	CSTF-2L055-S	TSL12R	-	KEYV-T10	T-6F-S
TLANL1616H12, TLANL1616M12S TLANL2020K12, TLANL2525M12	CSTB-3.5L115-S	CSTF-2L055-S	TSL12L	-	KEYV-T10	T-6F-S
TLANR2020K16, TLANR2525M16 TLANR3232P16, TLANR4040R16	CSTB-4L115-S	-	TSL16R	PSP-16	KEYV-T15	-
TLANL2020K16, TLANL2525M16 TLANL3232P16, TLANL4040R16	CSTB-4L115-S	-	TSL16L	PSP-16	KEYV-T15	-
TLANR3232P24, TLANR4040R24 TLANR5050S24	CSTB-5L163-S	-	TSL24R	PSP-16	KEYV-T20	-
TLANL3232P24, TLANL4040R24 TLANL5050S24	CSTB-5L163-S	-	TSL24L	PSP-16	KEYV-T20	-

INSERT

LNMX12/16/24

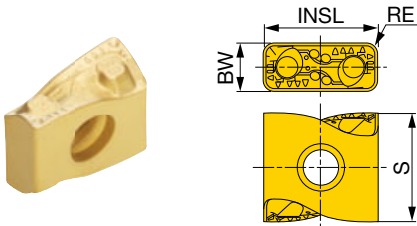

P Steel	★	★	★						
M Stainless	☆	☆	☆						
K Cast iron	☆	☆	☆						
N Non-ferrous									
S Superalloys									
H Hard materials									

★ : First choice
☆ : Second choice

Designation	HAND	RE	Coated			BW	INSL	S
			T9115	T9125	AH725			
LNMX120408R-TDR	R	0.8	●	●		4.8	12	11.6
LNMX120408L-TDR	L	0.8	●	●		4.8	12	11.6
LNMX120412R-TDR	R	1.2	●	●		4.8	12	11.6
LNMX120412L-TDR	L	1.2	●	●		4.8	12	11.6
LNMX160608R-TDR	R	0.8	●	●		6.4	16.2	13.5
LNMX160608L-TDR	L	0.8	●	●		6.4	16.2	13.5
LNMX160612R-TDR	R	1.2	●	●		6.4	16.2	13.5
LNMX160612L-TDR	L	1.2	●	●		6.4	16.2	13.5
LNMX160616R-TDR	R	1.6	●	●		6.4	16.2	13.5
LNMX160616L-TDR	L	1.6	●	●		6.4	16.2	13.5
LNMX241016R-TDR	R	1.6	●	●		9.4	24	20.5
LNMX241016L-TDR	L	1.6	●	●		9.4	24	20.5
LNMX241024R-TDR	R	2.4	●	●		9.4	24	20.5
LNMX241024L-TDR	L	2.4	●	●		9.4	24	20.5
LNMX160608R-MDR	R	0.8	●	●		6.4	16.2	13.5
LNMX160608L-MDR	L	0.8	●	●		6.4	16.2	13.5
LNMX160612R-MDR	R	1.2	●	●		6.4	16.2	13.5
LNMX160612L-MDR	L	1.2	●	●		6.4	16.2	13.5
LNMX160608R-TWR	R	0.8	●	●		6.4	16.2	13.5
LNMX160608L-TWR	L	0.8	●	●		6.4	16.2	13.5
LNMX160612R-TWR	R	1.2	●	●		6.4	16.2	13.5
LNMX160612L-TWR	L	1.2	●	●		6.4	16.2	13.5

● : Line up

Reference pages: Standard cutting conditions → **C119**

SRACR/L

Screw-on toolholder with 91° approach angle, for positive round inserts

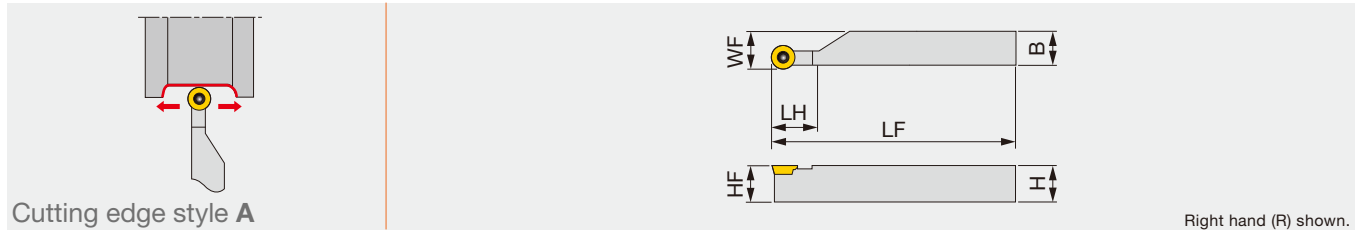

Designation	H	B	LF	LH	HF	WF	Insert
SRACR1010H05	10	10	100	10	10	10.3	RCMT0502...
SRACR/L1212H05	12	12	100	10	12	12.3	RCMT0502...
SRACR/L1212H06	12	12	100	12	12	12.4	RC*T0602...
SRACR1616H05	16	16	100	10	16	16.3	RCMT0502...
SRACR/L1616H06	16	16	100	12	16	16.4	RC*T0602...
SRACR/L1616H08	16	16	100	16	16	16.5	RC*T0803...
SRACR/L2020K05	20	20	125	10	20	20.3	RCMT0502...
SRACR/L2020K06	20	20	125	12	20	20.4	RC*T0602...
SRACR/L2020K08	20	20	125	16	20	20.5	RC*T0803...
SRACR/L2525M05	25	25	150	10	25	25.3	RCMT0502...
SRACR/L2525M06	25	25	150	12	25	25.4	RC*T0602...
SRACR/L2525M08	25	25	150	16	25	25.5	RC*T0803...

SPARE PARTS

Designation	Clamping screw	Wrench
SRACR/L1*1H05	CSTB-2.2R	T-7F
SRACR/L1212H06	CSTB-2.5	T-8F
SRACR1616H05	CSTB-2.2R	T-7F
SRACR/L1616H06	CSTB-2.5	T-8F
SRACR/L1616H08	CSTB-3	T-9F
SRACR/L2020K05	CSTB-2.2R	T-7F
SRACR/L2020K06	CSTB-2.5	T-8F
SRACR/L2020K08	CSTB-3	T-9F
SRACR/L2525M05	CSTB-2.2R	T-7F
SRACR/L2525M06	CSTB-2.5	T-8F
SRACR/L2525M08	CSTB-3	T-9F

INSERT SELECTION

P	Application	Finishing to medium cutting	heavy cutting	M	Application	heavy cutting
	Grade	T9215	T9215		Grade	T9215
	Chipbreaker shape				Chipbreaker shape	
Cutting conditions				B016		
Cutting conditions				B018		
K	Application	heavy cutting		N	Application	Finishing to medium cutting
	Grade	T9215			Grade	KS05F
	Chipbreaker shape				Chipbreaker shape	AL
Cutting conditions				B020		
Cutting conditions				B022		
S	Application	Finishing to medium cutting	heavy cutting			
	Grade	AH8015	AH8015			
	Chipbreaker shape					
Cutting conditions				B024		

Reference pages: SRACR/L: Inserts → **B130** -

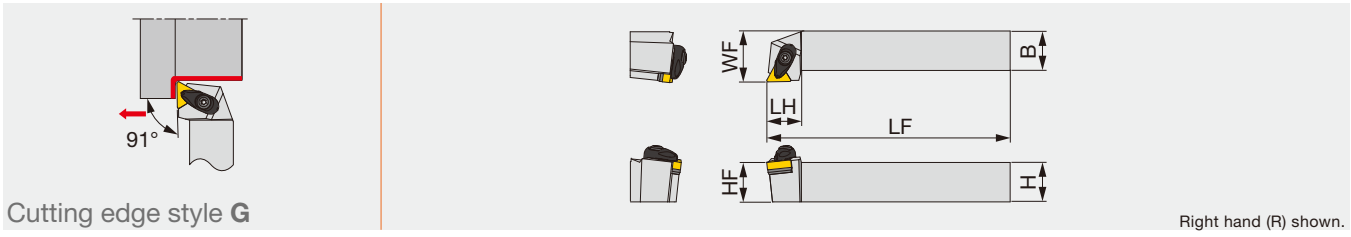

Designation	H	B	LF	LH	HF	WF	RE**	Insert	Torque*
ATG NR/L2020K16-A	20	20	125	22	20	25	0.8	TN**1604...	3
ATG NR/L2525M16-A	25	25	150	22	25	32	0.8	TN**1604...	3
ATG NR/L2525M22-A	25	25	150	26	25	32	0.8	TN**2204...	3

*Torque: Recommended clamping torque (N·m)
 **RE: Standard corner radius

SPARE PARTS

Designation	Clamp	Clamp screw	Spring	Spring pin	Shim	Shim screw	Wrench
ATG NR/L**16-A	ACP3S	ACS-5W	BP-7	SP-2.5	AST322	CSTB-3.5	T-15F
ATG NR/L**22-A	ACP4S	ACS-5W	BP-7	SP-2.5	AST422	CSTB-3.5	T-15F

INSERT SELECTION

Application	Precision finishing	Finishing	Medium cutting	Medium to heavy cutting
	Grade	NS9530	GT9530	T9215
Chipbreaker shape	TF	TSF	TM	TH
Cutting conditions	B004			

Application	Finishing	Medium cutting
	Grade	T6215
Chipbreaker shape	SF	SM
Cutting conditions	B006	

Application	Finishing	Medium cutting	Medium to heavy cutting
	Grade	T515	T515
Chipbreaker shape	All-round	All-round	All-round
Cutting conditions	B008		

Application	Precision finishing	Finishing	Medium cutting
	Grade	DX120	DX140
Chipbreaker shape	DIA	DIA with rake	P
Cutting conditions	B010		

Application	Precision finishing	Finishing	Medium cutting
	Grade	BX470	AH8005
Chipbreaker shape	CBN	HRF	HRM
Cutting conditions	B012		

Application	Precision finishing	Finishing
	Grade	BXA10
Chipbreaker shape	CBN	CBN
Cutting conditions	B014	

Reference pages: ATG NR/L: Inserts → B087 -, CBN → B182 -, PCD → B212



DTGNR/L

"One-Double" toolholder with 91° approach angle, for negative 60° triangular inserts

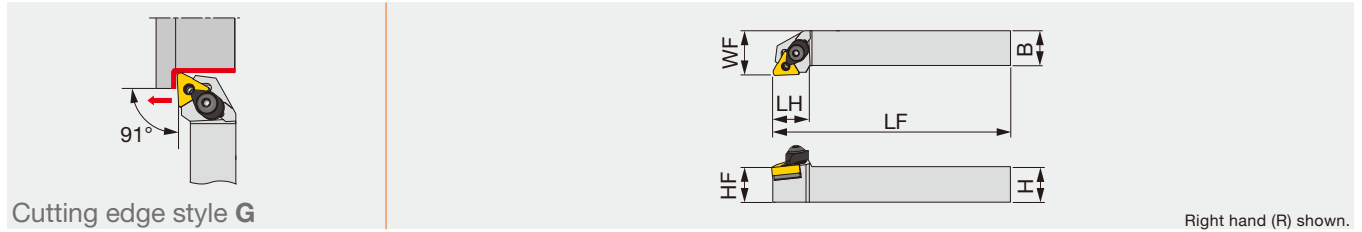

Designation	H	B	LF	LH	HF	WF	RE**	Insert
DTGNR/L2020K16	20	20	125	21	20	25	0.8	TN**1604...
DTGNR/L2525M16	25	25	150	21	25	32	0.8	TN**1604...
DTGNR/L2525M22	25	25	150	28	25	32	0.8	TN**2204...

Note: Except for 57-type chipbreaker inserts
**RE: Standard corner radius

SPARE PARTS									
Designation	Clamp	Lever	Piston	Clamp screw	Shim	Spring	Spring pin	Wrench 1	Wrench 2
DTGNR/L**16	DCPM-33	LCL33	DPIS33	DLCS33	LST317	BP-9	LSP3	P-2.5	P-3
DTGNR/L**22	DCPM-43	DLCL43	DPIS43	DLCS43	LST42	BP-10	LSP4	P-3	P-4

ISO TURN PTGNR/L

Lever-lock toolholder with 91° approach angle, for negative triangular inserts

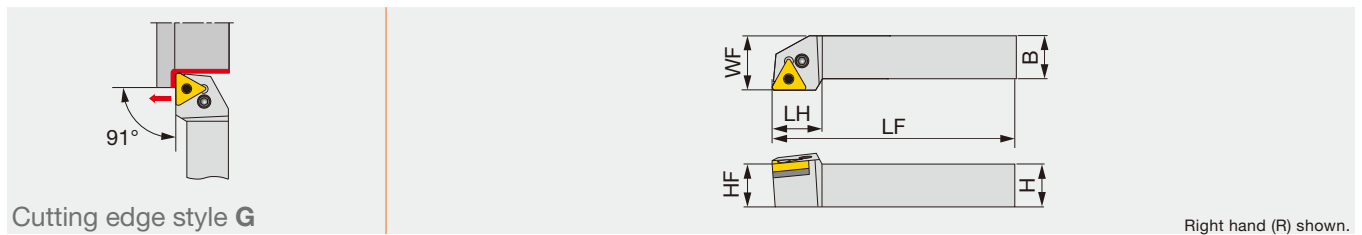

Designation	H	B	LF	LH	HF	WF	RE**	Insert	Torque*
PTGNR/L1616	16	16	100	22	16	20	0.8	TN**1604...	2
PTGNR/L2020K1104	20	20	125	20	20	25	0.8	TN**1104...	2
PTGNR/L2020	20	20	125	22	20	25	0.8	TN**1604...	2
PTGNR/L2525M1104	25	25	150	20	25	32	0.8	TN**1104...	2
PTGNR/L2525M3	25	25	150	22	25	32	0.8	TN**1604...	2
PTGNR/L2525M4	25	25	150	28	25	32	0.8	TN**2204...	3
PTGNR3225P4	32	25	170	28	32	32	0.8	TN**2204...	3

*Torque: Recommended clamping torque (N·m) **RE: Standard corner radius

SPARE PARTS					
Designation	Shim	Clamping screw	Wrench	Spring pin	Lever
PTGNR/L1616, 2020	LST317	LCS3	P-2.5	LSP3	LCL3
PTGNR/L**1104	-	LCS23A	P-2.5	-	LCL23
PTGNR/L2525M3	LST317	LCS3	P-2.5	LSP3	LCL3
PTGNR/L2525M4	LST42	LCS4	P-3	LSP4	LCL4
PTGNR3225P4	LST42	LCS4	P-3	LSP4	LCL4

Reference pages: DTGNR/L, PTGNR/L: Inserts → **B087 -**, CBN → **B182 -**, PCD → **B212**

Lever lock toolholders – 91° approach angle.
For negative triangle insert. High-pressure coolant capability.

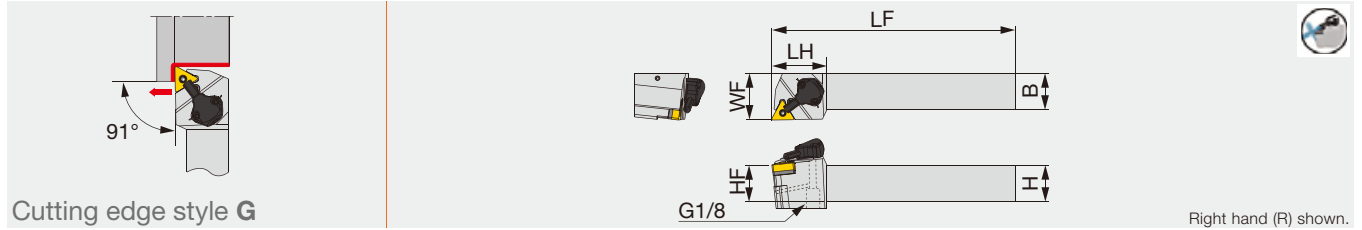

Designation	H	B	LF	LH	HF	WF	RE**	Insert	Torque*
PTGNR/L2020K1104-CHP	20	20	125	38	20	32	0.8	TN**1104...	2
PTGNR/L2020K16-CHP	20	20	125	38	20	32	0.8	TN**1604...	2
PTGNR/L2525M1104-CHP	25	25	150	38	25	32	0.8	TN**1104...	2
PTGNR/L2525M16-CHP	25	25	150	38	25	32	0.8	TN**1604...	2

*Torque: Recommended torque (N·m) for clamping
**RE: Standard corner radius

Designation	Shim	Clamping screw	Wrench 1	Spring pin	Lever
PTGNR/L**1104-CHP	-	LCS23A	P-2.5	LSP3	LCL23
PTGNR/L**16-CHP	LST317	LCS3	P-2.5	LSP3	LCL3

Designation	Coolant unit	Mounting screw	Wrench 2	O-ring	Coolant screw	Wrench 3
PTGNR/L**1104-CHP	CU-CW-CHP	SRM3	T-8F	OR6.4X0.9N	SRM4X4TL360	P-2
PTGNR/L**16-CHP	CU-CW-CHP	SRM3	T-8F	OR6.4X0.9N	SRM4X4TL360	P-2

INSERT SELECTION

Application	Precision finishing	Finishing	Medium cutting	Medium to heavy cutting
	Grade	NS9530	GT9530	T9215
Chipbreaker shape	TF	TSF	TM	TH
Cutting conditions	B004			

Application	Finishing	Medium cutting
	Grade	T6215
Chipbreaker shape	SF	SM
Cutting conditions	B006	

Application	Finishing	Medium cutting	Medium to heavy cutting
	Grade	T515	T515
Chipbreaker shape	All-round	All-round	All-round
Cutting conditions	B008		

Application	Precision finishing	Finishing	Medium cutting
	Grade	DX120	DX140
Chipbreaker shape	DIA	DIA with rake	P
Cutting conditions	B010		

Application	Precision finishing	Finishing	Medium cutting
	Grade	BX470	AH8005
Chipbreaker shape	CBN	HRF	HRM
Cutting conditions	B012		

Application	Precision finishing	Finishing
	Grade	BXA10
Chipbreaker shape	CBN	CBN
Cutting conditions	B014	

Reference pages: PTGNR/L-CHP: Inserts → **B087** -, CBN → **B182** -, PCD → **B212**
Parts for coolant hose → **C115**

Double-clamp toolholder with 91° approach angle, for negative round inserts

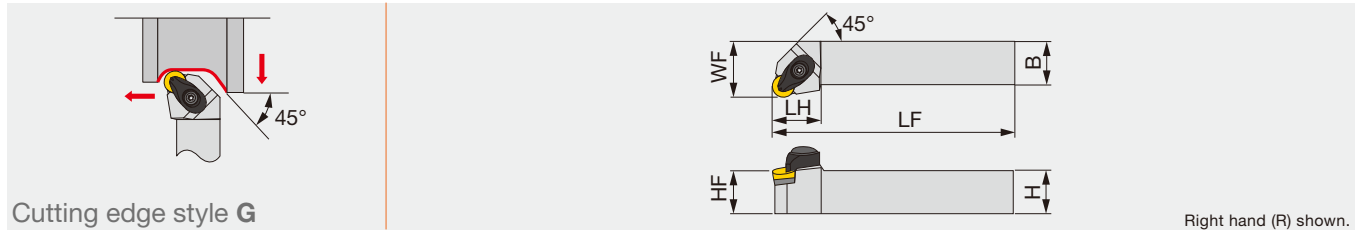

Designation	H	B	LF	LH	HF	WF	RE**	Insert	Torque*
ARGNR/L2525M12-A	25	25	150	28	25	32	6.35	RN**120400	3

*Torque: Recommended clamping torque (N·m)
 **RE: Standard corner radius

SPARE PARTS	Clamp	Clamp screw	Spring	Spring pin	Shim	Shim screw	Wrench
Designation	ACP4S	ACS-5W	BP-7	SP-2.5	ASR420	CSTB-3.5	T-15F

DRGNR/L

"One-Double" toolholder with 91° approach angle, for negative round inserts

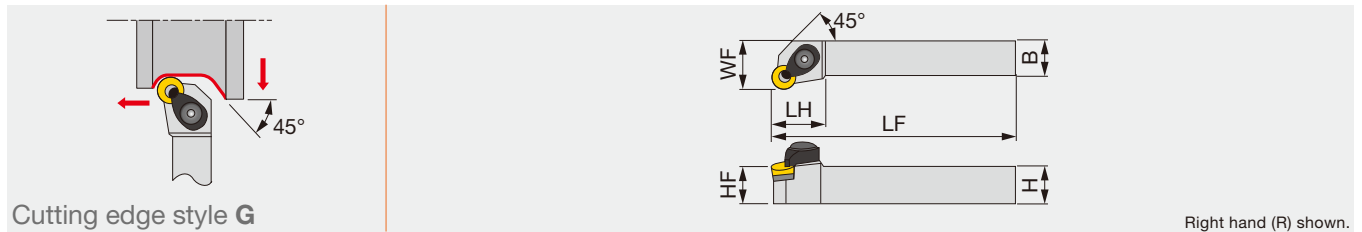

Designation	H	B	LF	LH	HF	WF	RE**	Insert
DRGNR/L2525M12	25	25	150	28	25	32	6.35	RN**120400

**RE: Standard corner radius

SPARE PARTS	Clamp	Lever	Piston	Clamp screw	Shim	Spring	Spring pin	Wrench 1	Wrench 2
Designation	DCPM-43	DLCL43	DPIS43	DLCS43	LSR42	BP-10	LSP4	P-3	P-4

PRGNR/L

Lever-lock toolholder with 91° approach angle, for negative round inserts

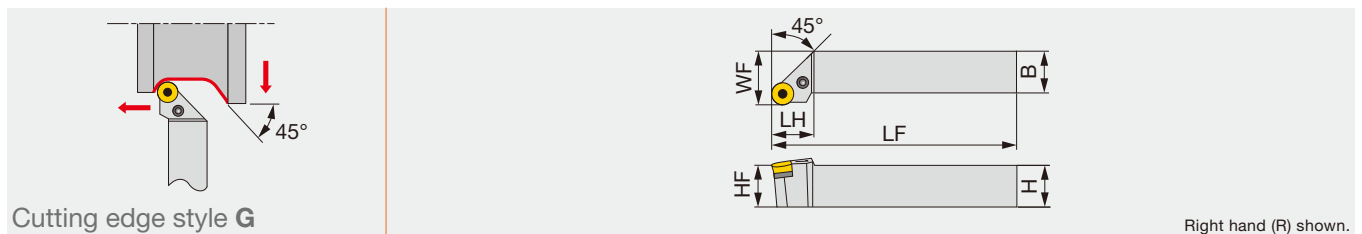

Designation	H	B	LF	LH	HF	WF	RE**	Insert
PRGNR/L2020	20	20	125	19	20	25	4.76	RNMG090300-61
PRGNR/L2525M4	25	25	150	25	25	32	6.35	RN**120400

**RE: Standard corner radius

SPARE PARTS	Shim	Clamping screw	Wrench	Spring pin	Lever
Designation	LSR32	LCS3	P-2.5	LSP3	LCL3
Designation	LSR42	LCS4	P-3	LSP4	LCL4

Reference pages: ARGNR/L, DRGNR/L, PRGNR/L: Inserts → **B076**

INSERT SELECTION

P	Applicadtion	Heavy cutting	M	Applicadtion	Heavy cutting	K	Applicadtion	Heavy cutting
	Grade	T9215		Grade	T9215		Grade	T9215
	Chipbreaker Shape	61		Chipbreaker Shape	61		Chipbreaker Shape	61
	Cutting conditions	B004		Cutting conditions	B006		Cutting conditions	B008
N	Applicadtion	Heavy cutting	S	Applicadtion	Heavy cutting	H	Applicadtion	Finishing to medium cutting
	Grade	TH10		Grade	TH10		Grade	LX11
	Chipbreaker Shape	61		Chipbreaker Shape	61		Chipbreaker Shape	
	Cutting conditions	B010		Cutting conditions	B012		Cutting conditions	B014

TRGNR/L-F

Toolholder with carbide clamping plate, with 90° approach angle, for negative round ceramic inserts without hole

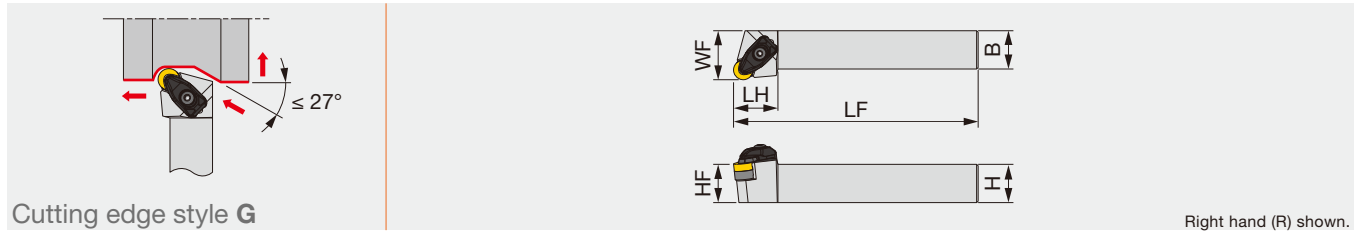

Designation	H	B	LF	LH	HF	WF	RE**	Insert
TRGNR/L2525M1207-F	25	25	150	29	25	32	6.35	RNGN1207...

**RE: Standard corner radius

SPARE PARTS

Designation	Clamp	Clamp screw	Shim	Shim screw	Spring	Wrench 1	Wrench 2
TRGNR/L2525M1207-F	DCLS-4F	DLS-4A	S-43	BH-M5X0.8X0.8	DSP-4A	T-15F	P-3

INSERT

RNGN-E/T1

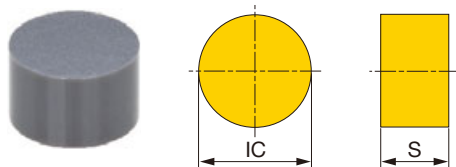

P Steel									
M Stainless									
K Cast iron									
N Non-ferrous									
S Superalloys	★	★							
H Hard materials									

★ : First choice

Designation	Edge prep.*	Ceramic								RE	IC	S	
		TS200	TS300										
RNGN120700-E	E	●	●								-	12.7	7.94
RNGN120700-T1	T1	●	●								-	12.7	7.94

* Types of cutting edge preparations

● : Line up

E: Low cutting force

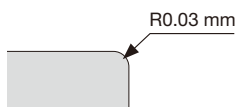

T1: Strong cutting edge

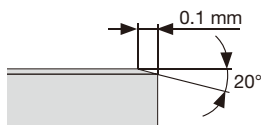

PRGCR/L

Lever-lock toolholder with 91° approach angle, for positive round inserts

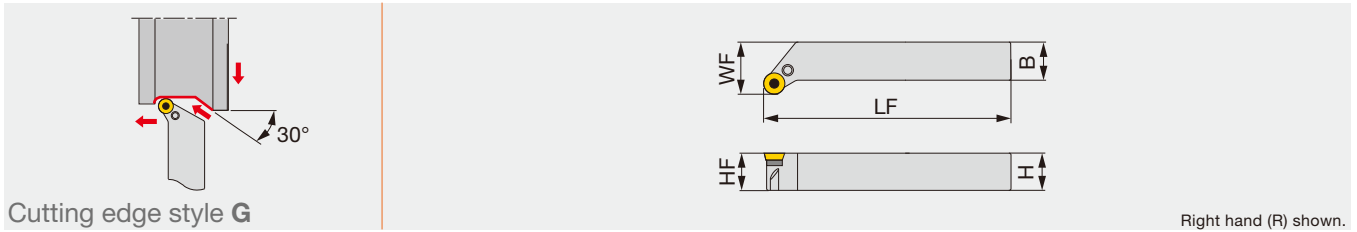

Right hand (R) shown.

Designation	H	B	LF	HF	WF	Insert
PRGCR/L2020K10	20	20	125	20	25	RCMM1003...
PRGCR/L2525M12	25	25	150	25	32	RCM*1204...
PRGCR/L3225P16	32	25	170	32	32	RCM*1606...
PRGCR/L3232P20	32	32	170	32	40	RCM*2006...

SPARE PARTS

Designation	Shim	Clamping screw	Wrench	Spring pin	Lever
PRGCR/L2020K10	LSR32C	LCS2	P-2	LSP3	LCL3C
PRGCR/L2525M12	LSR42C	LCS3	P-2.5	LSP3	LCL4C
PRGCR/L3225P16	LSR53C	LCS5	P-3	LSP4	LCL5C
PRGCR/L3232P20	LSR63C	LCS5	P-3	LSP6C	LCL6C

INSERT SELECTION

P	Application	Finishing to medium cutting	heavy cutting	M	Application	heavy cutting	
	Grade	T9215	T9215		Grade	T9215	
	Chipbreaker shape				Chipbreaker shape		
Cutting conditions			B016	Cutting conditions			B018
K	Application	heavy cutting		N	Application	Finishing to medium cutting	
	Grade	T9215			Grade	KS05F	
	Chipbreaker shape				Chipbreaker shape		
Cutting conditions			B020	Cutting conditions			B022
S	Application	Finishing to medium cutting	heavy cutting				
	Grade	AH8015	AH8015				
	Chipbreaker shape						
Cutting conditions			B024				

Reference pages: PRGCR/L: Inserts → **B130** -

SRGCR/L

Screw-on toolholder with 91° approach angle, for positive round inserts

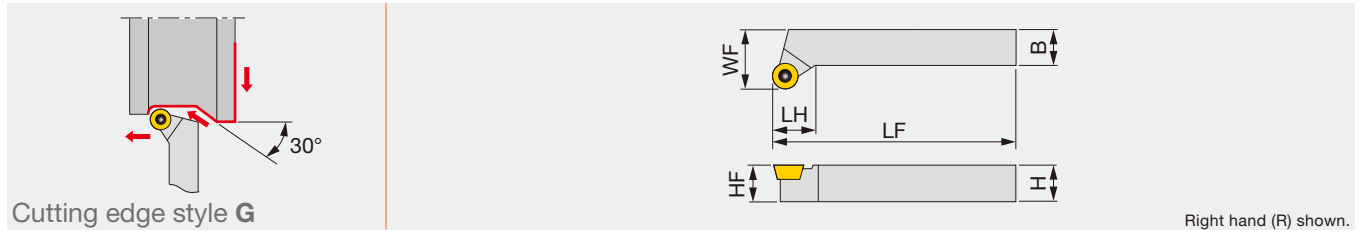

Designation	H	B	LF	LH	HF	WF	Insert
SRGCR1212H05	12	12	100	9.5	12	16	RCMT0502...
SRGCR/L1212H06	12	12	100	10	12	16	RC*T0602...
SRGCR/L1616H05	16	16	100	9.5	16	20	RCMT0502...
SRGCR/L1616H06	16	16	100	10	16	20	RC*T0602...
SRGCR/L1616H08	16	16	100	11	16	20	RC*T0803...
SRGCR/L2020K05	20	20	125	11.2	20	25	RCMT0502...
SRGCR/L2020K06	20	20	125	12	20	25	RC*T0602...
SRGCR/L2020K08	20	20	125	12.7	20	25	RC*T0803...
SRGCR/L2020K10	20	20	125	14	25	25	RC*T1003...
SRGCR/L2525M05	25	25	150	14.7	25	32	RCMT0502...
SRGCR/L2525M06	25	25	150	15	25	32	RC*T0602...
SRGCR/L2525M08	25	25	150	16.2	25	32	RC*T0803...
SRGCR/L2525M10	25	25	150	17.5	25	32	RC*T1003...

Designation	Clamping screw	Shim screw	Shim	Wrench 1	Wrench 2
SRGCR1212H05	CSTB-2.2R	-	-	-	T-7F
SRGCR/L1212H06	CSTB-2.5	-	-	-	T-8F
SRGCR/L1616H05	CSTB-2.2R	-	-	-	T-7F
SRGCR/L1616H06	CSTB-2.5	-	-	-	T-8F
SRGCR/L1616H08	CSTB-3	-	-	-	T-9F
SRGCR/L2020K05	CSTB-2.2R	-	-	-	T-7F
SRGCR/L2020K06	CSTB-2.5	-	-	-	T-8F
SRGCR/L2020K08	CSTB-3	-	-	-	T-9F
SRGCR/L2020K10	CSTB-3.5L	DTS5-3.5	SSR32	P-3.5	T-15F
SRGCR/L2525M05	CSTB-2.2R	-	-	-	T-7F
SRGCR/L2525M06	CSTB-2.5	-	-	-	T-8F
SRGCR/L2525M08	CSTB-3	-	-	-	T-9F
SRGCR/L2525M10	CSTB-3.5L	DTS5-3.5	SSR32	P-3.5	T-15F

INSERT SELECTION

P	Application	Finishing to medium cutting	heavy cutting	M	Application	heavy cutting
	Grade	T9215	T9215		Grade	T9215
	Chipbreaker shape				Chipbreaker shape	
Cutting conditions				B016		
Cutting conditions				B018		
K	Application	heavy cutting	N	Application	Finishing to medium cutting	
	Grade	T9215		Grade	KS05F	
	Chipbreaker shape			Chipbreaker shape		
Cutting conditions				B020		
Cutting conditions				B022		
S	Application	Finishing to medium cutting	heavy cutting			
	Grade	AH8015	AH8015			
	Chipbreaker shape					
Cutting conditions				B024		

Reference pages: SRGCR/L: Inserts → B130 -

Grade A
 Insert B
 Ext. Toolholder C
 Int. Toolholder D
 Threading E
 Grooving F
 Miniature tool G
 Milling cutter H
 Endmill I
 Drilling tool J
 Tooling System K
 User's Guide L
 Index M

Screw-on toolholder with 91° approach angle, for positive round inserts

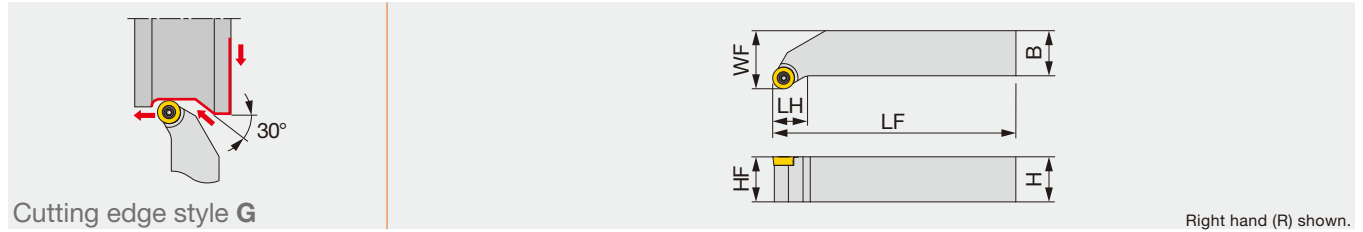

Right hand (R) shown.

Designation	H	B	LF	LH	HF	WF	Insert	Torque*
SRGCR/L2525M12-6F	25	25	150	18.6	25	32	RCMT1204M0-6RS/-6RM	3

*Torque: Recommended clamping torque (N·m)

SPARE PARTS

Designation	Clamping screw	Lubricant	Wrench
SRGCR/L2525M12-6F	CSTB-4	M-1000	T-15F

INSERT

RCMT

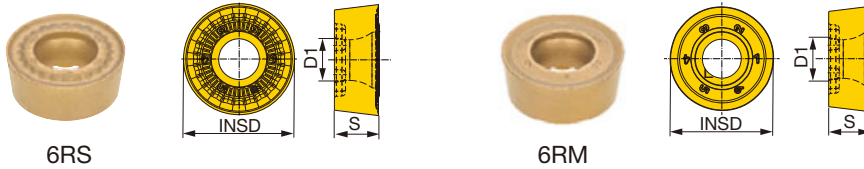

	P	M	K	N	S	H
Steel	★	★				★
Stainless	☆					
Cast iron	☆	☆				☆
Non-ferrous						
Superalloys						
Hard materials						

★ : First choice
☆ : Second choice

Designation	Coated		Cermet		INSD	S	D1
	T9215	T9225	NS9530				
RCMT1204M0-6RS	●	●	●		12	4.76	5.16
RCMT1204M0-6RM	●	●	●		12	4.76	5.16

● : Line up

Double-clamp toolholder with 95°/117.5° approach angle, for negative 80°/35° triangular inserts

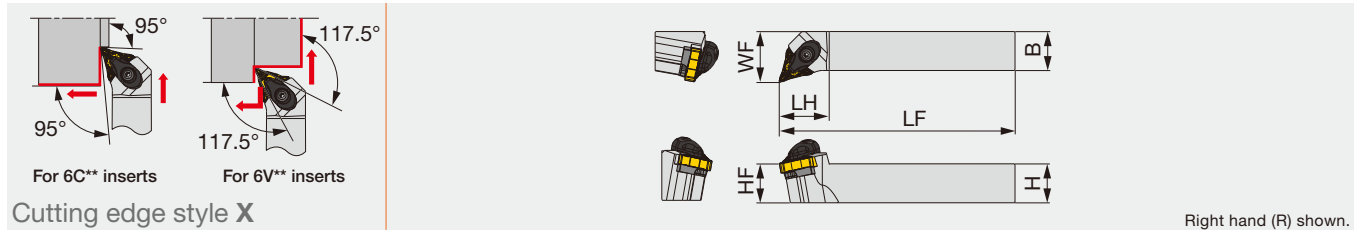

Designation	H	B	LF	LH	HF	WF	RE**	Insert	Torque*
ATXOR/L2020K25-A	20	20	125	32	20	25	0.8	6C/6V-TOMG2506...	3
ATXOR/L2525M25-A	25	25	150	32	25	32	0.8	6C/6V-TOMG2506...	3
ATXOR/L3232P25-A	32	32	170	32	32	40	0.8	6C/6V-TOMG2506...	3

Torque*: Recommended clamping torque (N·m)
RE**: Standard corner radius

SPARE PARTS

Designation	Clamp	Clamp screw	Spring	Spring pin	Shim	Shim screw	Wrench
ATXOR/L**25-A	ACP4S	ACS-5W	BP-7	SP-2.5	LST33 KS15F	CSTB-3.5	T-15F

INSERT

6V-TOMG**F-TSF

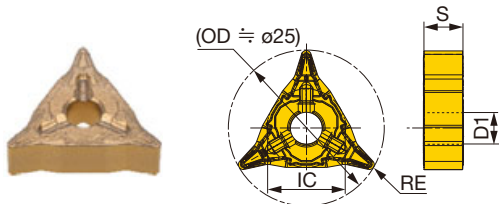

6C-TOMG**M-TM

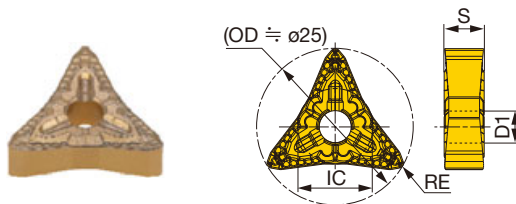

P	Steel	★	★					
M	Stainless	☆	☆					
K	Cast iron	☆						
N	Non-ferrous							
S	Superalloys		★					
H	Hard materials							

★ : First choice
☆ : Second choice

Designation	RE	Coated			IC	S	D1
		T9215	T9225	AH8015			
6V-TOMG250604F-TSF	0.4	●	●	●	12.7	6.35	5.16
6V-TOMG250608F-TSF	0.8	●	●	●	12.7	6.35	5.16
6C-TOMG250608M-TM	0.8	●	●	●	12.1	6.35	5.16
6C-TOMG250612M-TM	1.2	●	●	●	12.1	6.35	5.16

Please note, when machining with pull face-turning method, that 6V-TOMG2506... insert may interfere with the workpiece whose external diameter is 70 mm or smaller and that 6C-TOMG2506... insert 30 mm or smaller.

● : Line up



Screw-on toolholder with 105° approach angle, for positive triangular inserts

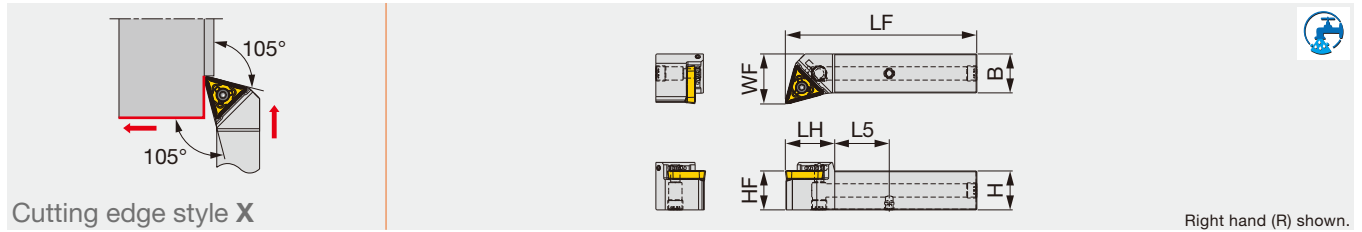

Designation	H	B	LF	LH	HF	WF	L5	Insert	Torque*
STXCR/L2525X29-CHP-MC	25	25	122	32	25	32	35	3C-TCMT29X6...	5

Torque*: Recommended clamping torque (N-m)

SPARE PARTS

Designation	Clamping screw	Grip	Torx bit	Coolant plug
STXCR/L2525X29-CHP-MC	CSTB-5	H-TB2W	BT20M	PLUGG1/8-6.5TL360

INSERT

3C-TCMT**-TM

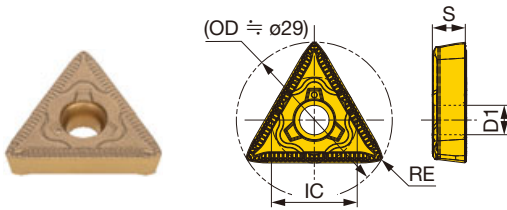

P	Steel	★								
M	Stainless	☆								
K	Cast iron	☆								
N	Non-ferrous									
S	Superalloys									
H	Hard materials									

★ : First choice
☆ : Second choice

Designation	RE	Coated								IC	S	D1
		T9215										
3C-TCMT29X608-TM	0.8	●								16	6.15	5.5

Please note that 3C-TCMT... insert is not recommended for pull face-turning method (pulling the insert away from the part center).

● : Line up

Lever-lock toolholder with 48.5° approach angle, for negative 108° pentagonal inserts

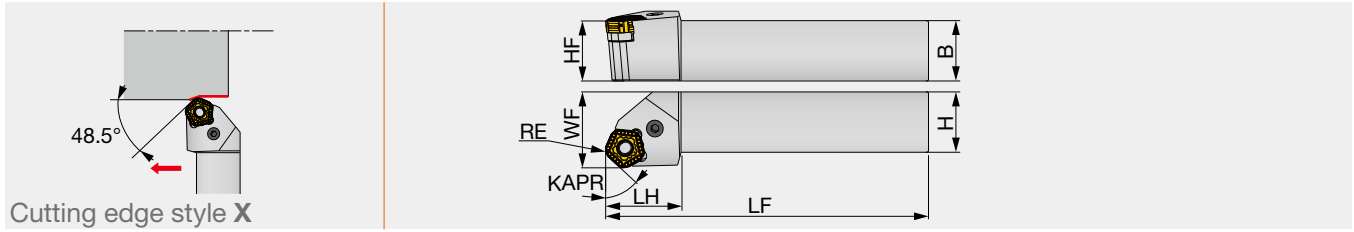

Designation	H	B	LF	LH	HF	WF	KAPR	RE	Insert
PPXOR/L2525M11-HD	25	25	150	35	25	32	48.5	1.2	POMG110612...
PPXOR/L3232P13-HD	32	32	170	40	32	40	48.5	1.2	POMG130612...

Note : Since the corner angle of TurnTenFeed insert is 108°, the workpiece corner may require additional post-process to remove stock to achieve a right angle.

PPXOR/L-HF

Lever-lock toolholder with 22.5° approach angle, for negative 108° pentagonal inserts

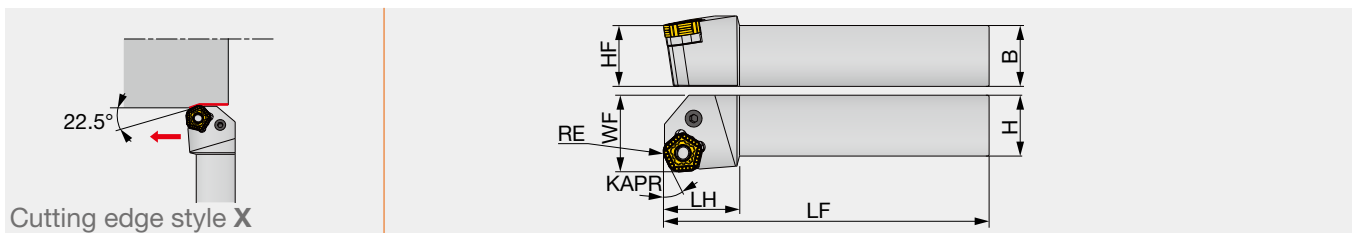

Designation	H	B	LF	LH	HF	WF	KAPR	RE	Insert
PPXOR/L2525M11-HF	25	25	150	35	25	32	22.5	1.2	POMG110612...
PPXOR/L3232P13-HF	32	32	170	40	32	40	22.5	1.2	POMG130612...

Note : Since the corner angle of TurnTenFeed insert is 108°, the workpiece corner may require additional post-process to remove stock to achieve a right angle.

SPARE PARTS

Designation	Shim	Spring pin	Lever	Clamping screw	Wrench
PPXOR/L2525M11-H*	LSPO53	LSP5	LCL5	LCS5	P-3
PPXOR/L3232P13-H*	LSPO63	LSP6	LCL6	LCS6	P-4

INSERT

POMG-MNW

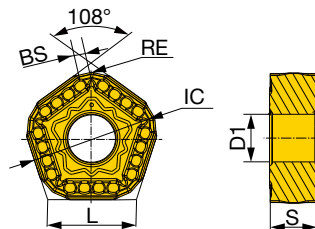

	P	M	K	N	S	H
Steel	★	★				
Stainless	☆		☆			
Cast iron	☆	☆				
Non-ferrous						
Superalloys			★			
Hard materials						

★ : First choice
☆ : Second choice

Designation	RE	Coated			IC	L	BS	S	D1
		T9215	T9225	AH8015					
POMG110612-MNW	1.2	●	●	●	15.875	11.53	1.5	6.35	6.35
POMG130612-MNW	1.2	●	●	●	19.05	13.84	2	6.35	7.93

● : Line up

Reference pages: Standard cutting conditions → [C117](#)



Double-clamp toolholder for roughing with 20° approach angle, for positive 80° trigon inserts

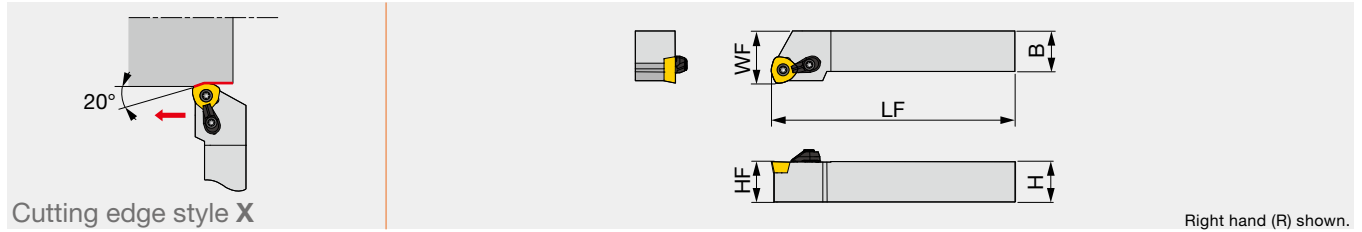

Right hand (R) shown.

Designation	H	B	LF	HF	WF	Insert
XWXPR/L2525M09	25	25	150	25	32	WPMT090725ZPR/L-ML
XWXPR/L3232P09	32	32	170	32	40	WPMT090725ZPR/L-ML
XWXPR/L4040S09	40	40	250	40	50	WPMT090725ZPR/L-ML

SPARE PARTS			
Designation	Clamp set	Clamping screw	Wrench
XWXPR/L...	CSY-20	CSPB-5	IP-20T

Note: Each insert is either right- or left-handed. Please be sure not to use a wrong insert.

INSERT

WPMT09-ML

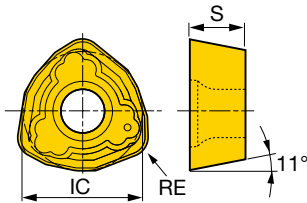

P Steel	★	★	★																	
M Stainless	☆	☆	☆																	
K Cast iron	☆	☆	☆																	
N Non-ferrous																				
S Superalloys																				
H Hard materials																				

★ : First choice
☆ : Second choice

Designation	RE	Coated										IC	S	
		T9215	T9225	AH120										
WPMT090725ZPR-ML	2.5	●	●	●									15	7
WPMT090725ZPL-ML	2.5	●	●	●									15	7

● : Line up

Reference pages: Standard cutting conditions → C117

Screw-on Y-axis turning toolholder with TungCap connection, for positive triangular inserts

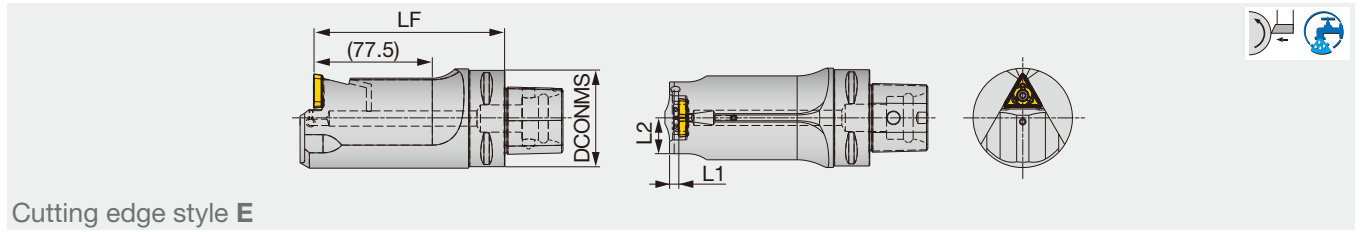

Cutting edge style E

Designation	SS	DCONMS	LF	L1	L2	RE	Insert	Torque*
C6STECHN00125-29-Y-CHP	C6	63	125	6	23.5	0.8	3C-TCMT29X6...	5

Torque*: Recommended clamping torque (N-m)

SPARE PARTS

Designation	Clamping screw	Grip	Torx bit
C6STECHN00125-29-Y-CHP	CSTB-5	H-TB2W	BT20M

INSERT

3C-TCMT**-TM

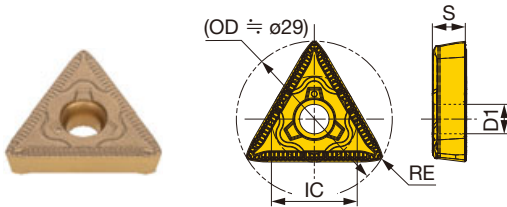

P	Steel	★							
M	Stainless	☆							
K	Cast iron	☆							
N	Non-ferrous								
S	Superalloys								
H	Hard materials								

★ : First choice
☆ : Second choice

Designation	RE	Coated						IC	S	D1
3C-TCMT29X608-TM	0.8	●						16	6.15	5.5

Please note that 3C-TCMT... insert is not recommended for pull face-turning method (pulling the insert away from the part center).

● : Line up

Screw-on Y-axis turning toolholder with TungCap connection, for positive 55° rhombic inserts

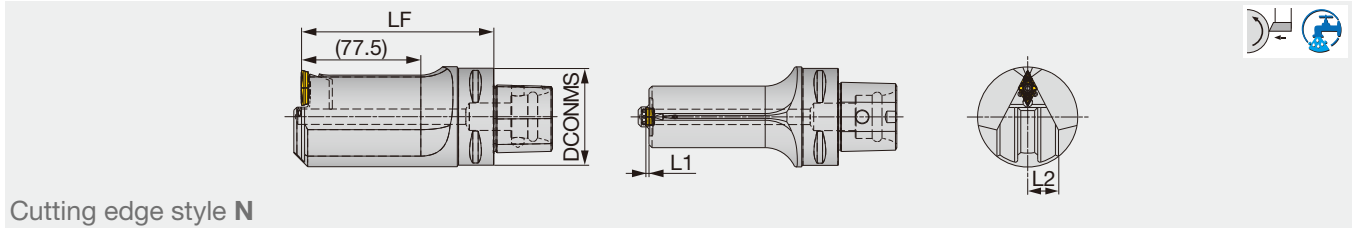

Cutting edge style N

Designation	SS	DCONMS	LF	L1	L2	RE	Insert	Torque*
C6SDNCHN00125-13-Y-CHP	C6	63	125	2	20	0.4	2D-DCMT13T4...	3.5

Torque*: Recommended clamping torque (N-m)

SPARE PARTS

Designation	Clamping screw	Grip	Torx bit
C6SDNCHN00125-13-Y-CHP	CSTB-4M	H-TB2W	BT15M

INSERT

2D-DCMT**-ZF

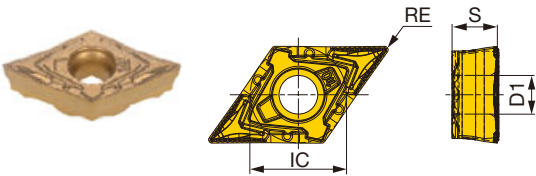

	P	M	K	N	S	H
Steel	★					
Stainless	☆					
Cast iron	☆					
Non-ferrous						
Superalloys						
Hard materials						

★ : First choice
☆ : Second choice

Designation	RE	Coated								IC	S	D1
		T9215										
2D-DCMT13T404-ZF	0.4	●								11	5.16	4.4

Please note that 2D-DCMT... insert is not recommended for pull face-turning method (pulling the insert away from the part center).

● : Line up

Double-clamp toolholder, with 62.5° approach angle, for negative 55°/45° rhombic inserts

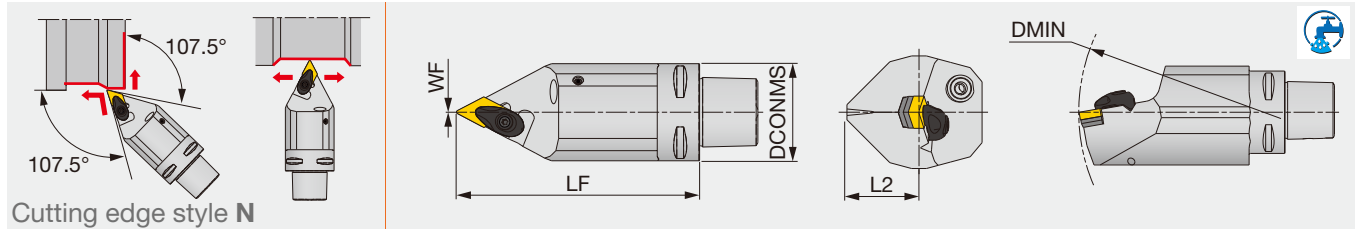

Designation	DCONMS	LF	L2	WF	DMIN	RE	Insert
C5ADNNN00090-15 ⁽¹⁾	50	90	32	0	-	0.8	DN**/FNGA1504(06)...
C5ADNNN00090-15N ⁽²⁾	50	90	32	0	165	0.8	DN**/FNGA1504(06)...
C5ADNNN00125-15 ⁽¹⁾	50	125	32	0	-	0.8	DN**/FNGA1504(06)...
C5ADNNN00125-15N ⁽²⁾	50	125	32	0	165	0.8	DN**/FNGA1504(06)...
C6ADNNN00100-15N ⁽²⁾	63	100	37.5	0	190	0.8	DN**/FNGA1504(06)...
C6ADNNN00140-15N ⁽²⁾	63	140	37.5	0	190	0.8	DN**/FNGA1504(06)...

The items without DMIN cannot be used for boring
 (1) Applicable for 3 MPa coolant (2) Applicable for 7 MPa coolant

Designation	Clamp	Clamp screw	Coolant parts	Shim	Shim screw	Spring	Spring pin	Wrench
C5ADNNN00090-15	ACP4S	ACS-5W	EZ104	ASD432	CSTB-3.5	BP-7	SP-2.5	T-15F
C5ADNNN00090-15N	ACP4S	ACS-5W	SATZ-M10X1-M5	ASD432	CSTB-3.5	BP-7	SP-2.5	T-15F
C5ADNNN00125-15	ACP4S	ACS-5W	EZ104	ASD432	CSTB-3.5	BP-7	SP-2.5	T-15F
C5ADNNN00125-15N	ACP4S	ACS-5W	SATZ-M10X1-M5	ASD432	CSTB-3.5	BP-7	SP-2.5	T-15F
C6ADNNN00100-15N	ACP4S	ACS-5W	SATZ-M10X1-M5	ASD432	CSTB-3.5	BP-7	SP-2.5	T-15F
C6ADNNN00140-15N	ACP4S	ACS-5W	SATZ-M10X1-M5	ASD432	CSTB-3.5	BP-7	SP-2.5	T-15F

Option: ASD423 (Shim for DN**1506**)

INSERT SELECTION

P	Application	Precision finishing	Finishing	Medium cutting	Medium to heavy cutting
	Grade	NS9530	GT9530	T9215	T9215
	Chipbreaker shape	TF	TSF	TM	TH
	Cutting conditions	B004			
M	Application	Finishing	Medium cutting	Medium to heavy cutting	
	Grade	T6215	AH6225	AH6225	
	Chipbreaker shape	SF	SM	SH	
	Cutting conditions	B006			
K	Application	Finishing	Medium cutting	Medium to heavy cutting	
	Grade	T515	T515	T515	
	Chipbreaker shape	All-round	All-round	All-round	
	Cutting conditions	B008			
N	Application	Precision finishing	Finishing	Medium cutting	
	Grade	DX120	DX140	TH10	
	Chipbreaker shape	DIA	with rake DIA	P	
	Cutting conditions	B010			
S	Application	Precision finishing	Finishing	Medium cutting	
	Grade	BX470	AH8005	AH8005	
	Chipbreaker shape	CBN	HRF	HRM	
	Cutting conditions	B012			
H	Application	Precision finishing	Finishing		
	Grade	BXA10	BXA20		
	Chipbreaker shape	CBN	CBN		
	Cutting conditions	B014			

Reference pages: C-ADNNN: Inserts → **B066 -**, CBN → **B172 -**, PCD → **B211**
 Parts for coolant hose → **C115**



Double-clamp toolholder with 63° approach angle, for negative 55° rhombic ceramic inserts with dimple

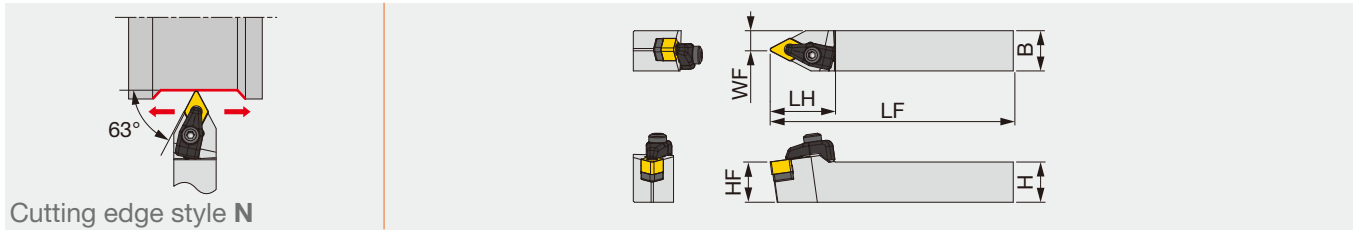

Designation	H	B	LF	LH	HF	WF	RE**	Insert	Torque*
CDNNN2525M1507-RD	25	25	150	40	25	12.5	1.2	DN*D1507...	4

*Torque: Recommended clamping torque (N·m)
 **RE: Standard corner radius

SPARE PARTS

Designation	Clamp	Clamp screw	Shim	Shim screw	Spring	Wrench1	Wrench2
CDNNN2525M1507-RD	CCP4-A	CCS4-A	CD44-A	BH5-10-A	BP-5-A	P-3	P-4

- L
- J
- V
- I
- A
- G
- X
- E
- N**
- D
- S
- K
- F
- Q
- H
- B
- R
- Special

INSERT SELECTION

K	Application	Finishing to medium cutting
	Grade	FX105
	Chipbreaker shape	
	Cutting conditions	C118

Reference pages: CDNNN-RD: Inserts → **B074**
 Standard cutting conditions → **C118**

SDNCN

Screw-on toolholder with 62.5° approach angle, for positive 55° rhombic inserts

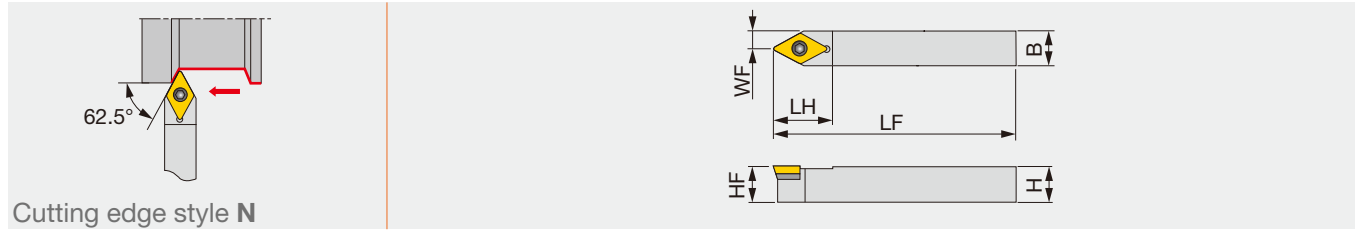

Designation	H	B	LF	LH	HF	WF	RE**	Insert
SDNCN1616H11	16	16	100	21	16	8	0.8	DC**11T3...
SDNCN2020K11	20	20	125	21	20	10	0.8	DC**11T3...
SDNCN2525M11	25	25	150	21	25	12.5	0.8	DC**11T3...

**RE: Standard corner radius

SPARE PARTS

Designation	Clamping screw	Shim screw	Shim	Wrench1	Wrench2
SDNCN...	CSTB-3.5L	DTS5-3.5	SSD32	P-3.5	T-15F

INSERT SELECTION

P

Application	Finishing	Finishing to medium cutting	Medium cutting
Grade	NS9530	T9215	T9215
Chipbreaker shape	PSS	PS	PM
Cutting conditions	B016		

M

Application	Precision finishing	Finishing	Finishing to medium cutting	Medium cutting
Grade	GH330	AH6225	AH6225	AH6225
Chipbreaker shape	W**	PSS	PS	PM
Cutting conditions	B018			

K

Application	Finishing to medium cutting
Grade	T515
Chipbreaker shape	CM
Cutting conditions	B020

N

Application	Precision finishing	Finishing	Medium cutting
Grade	DX120	DX140	KS05F
Chipbreaker shape	DIA	with rake DIA	AL
Cutting conditions	B022		

S

Application	Finishing	Finishing to medium cutting
Grade	AH8015	AH8015
Chipbreaker shape	PSS	PS
Cutting conditions	B024	

H

Application	Precision finishing	Finishing
Grade	BXA10	BXA20
Chipbreaker shape	CBN	CBN
Cutting conditions	B026	

Reference pages: SDNCN:Inserts → B121 -, CBN → B193 -, PCD → B214

Grade
A
Insert
B
Ext. Toolholder
C
Int. Toolholder
D
Threading
E
Grooving
F
Miniature tool
G
Milling cutter
H
Endmill
I
Drilling tool
J
Tooling System
K
User's Guide
L
Index
M

Double-clamp toolholder with 45° approach angle, for negative square inserts

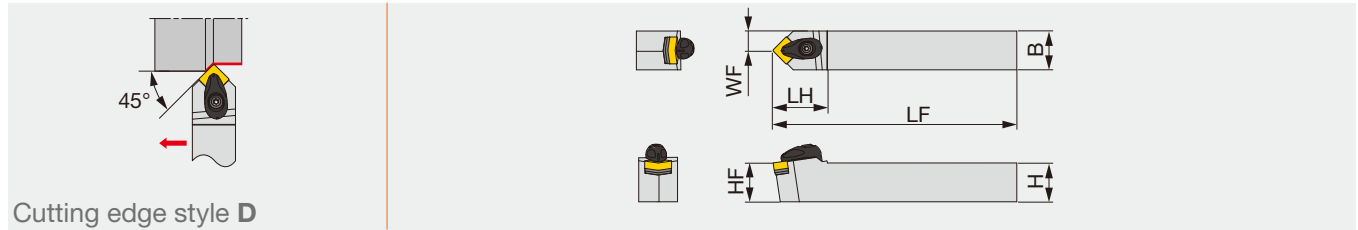

Designation	H	B	LF	LH	HF	WF	RE**	Insert	Torque*
ASDNN2020K12-A	20	20	125	35	20	10	0.8	SN**1204...	3
ASDNN2525M12-A	25	25	150	35	25	12.5	0.8	SN**1204...	3

*Torque: Recommended clamping torque (N·m) **RE: Standard corner radius

SPARE PARTS							
Designation	Clamp	Clamp screw	Spring	Spring pin	Shim	Shim screw	Wrench
ASDNN**12-A	ACP4S	ACS-5W	BP-7	SP-2.5	ASS422	CSTB-3.5	T-15F

DSDNN

One-Double toolholder with 45° approach angle, for negative square inserts

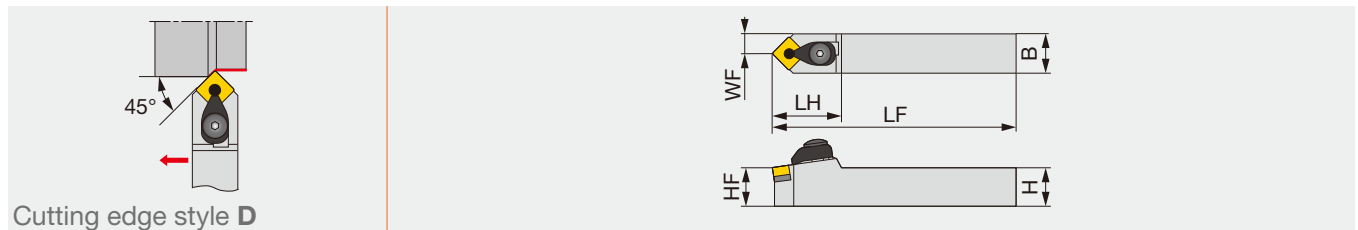

Designation	H	B	LF	LH	HF	WF	RE**	Insert
DSDNN2020K12	20	20	125	36	20	10	0.8	SN**1204...
DSDNN2525M12	25	25	150	36	25	12.5	0.8	SN**1204...

Note: Except for TRS, TU, TUS, 57, and 65-type chipbreaker inserts

**RE: Standard corner radius

SPARE PARTS									
Designation	Clamp	Lever	Piston	Clamp screw	Shim	Spring	Spring pin	Wrench 1	Wrench 2
DSDNN...	DCPM-43	DLCL43	DPIS43	DLCS43	LSS42	BP-10	LSP4	P-3	P-4

PSDNN

Lever-lock toolholder with 45° approach angle, for positive round inserts

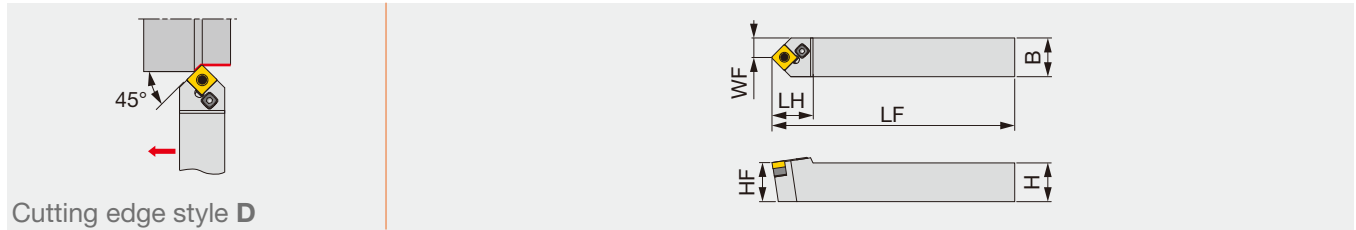

Designation	H	B	LF	LH	HF	WF	RE**	Insert
PSDNN1616	16	16	100	22	16	8	0.8	SN**0903...
PSDNN2020	20	20	125	30	20	10.3	0.8	SN**1204...
PSDNN2525	25	25	150	30	25	12.8	0.8	SN**1204...

**RE: Standard corner radius

SPARE PARTS					
Designation	Shim	Clamping screw	Wrench	Spring pin	Lever
PSDNN1616	LSS33	LCS3	P-2.5	LSP3L	LCL3
PSDNN2020	LSS42	LCS4	P-3	LSP4	LCL4
PSDNN2525	LSS42	LCS4	P-3	LSP4	LCL4

INSERT SELECTION

Application	Precision finishing	Finishing	Medium cutting	Medium to heavy cutting
	Grade	Grade	Grade	Grade
	NS9530	GT9530	T9215	T9215
Chipbreaker Shape	TF	TSF	TM	TH
Cutting conditions	B004			

Application	Finishing	Medium cutting	Medium to heavy cutting
	Grade	Grade	Grade
	T6215	AH6225	AH6225
Chipbreaker Shape	SF	SM	SH
Cutting conditions	B006		

Application	Finishing	Medium cutting	Medium to heavy cutting
	Grade	Grade	Grade
	T515	T515	T515
Chipbreaker Shape	All-round	All-round	All-round
Cutting conditions	B008		

Application	Finishing	Medium cutting
	Grade	Grade
	DX140	TH10
Chipbreaker Shape	DIA	P
Cutting conditions	B010	

Application	Precision finishing	Finishing	Medium cutting
	Grade	Grade	Grade
	BX480	AH8005	AH8005
Chipbreaker Shape	CBN	HRF	HRM
Cutting conditions	B012		

Reference pages: PSDNN: Inserts → **B077 -**, CBN → **B180**, PCD → **B211**

Grade
Insert
Ext. Toolholder
Int. Toolholder
Threading
Grooving
Miniature tool
Milling cutter
Endmill
Drilling tool
Tooling System
User's Guide
Index

PRDCN

Lever-lock toolholder with 45° approach angle, for positive round inserts

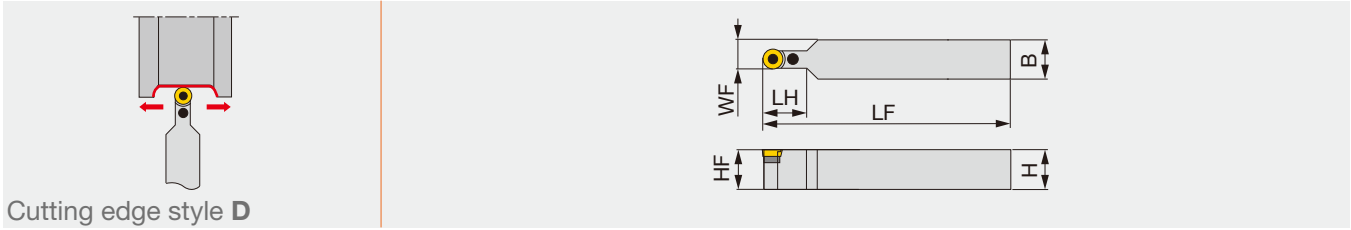

Designation	H	B	LF	LH	HF	WF	Insert
PRDCN2020K10	20	20	125	22.5	20	15	RCMM1003...
PRDCN2525M12	25	25	150	24	25	18.5	RCM*1204...
PRDCN3225P12	32	25	170	24	32	18.5	RCM*1204...
PRDCN3225P16	32	25	170	28	32	20.5	RCM*1606...
PRDCN3232P20	32	32	170	32	32	26	RCM*2006...
PRDCN4040R25	40	40	200	42	40	32.5	RCM*2507...

SPARE PARTS

Designation	Shim	Clamping screw	Wrench	Spring pin	Lever
PRDCN2020K10	LSR32C	LCS2	P-2	LSP3	LCL3C
PRDCN**25*12	LSR42C	LCS3	P-2.5	LSP3	LCL4C
PRDCN3225P16	LSR53C	LCS5	P-3	LSP4	LCL5C
PRDCN3232P20	LSR63C	LCS5	P-3	LSP6C	LCL6C
PRDCN4040R25	LSR84C	LCS8C	P-4	LSP6	LCL8C

INSERT SELECTION

P	Application	Finishing to medium cutting	Heavy cutting	M	Application	Heavy cutting
	Grade	T9215	T9215		Grade	T9215
	Chipbreaker Shape				Chipbreaker Shape	
	Cutting conditions	B016			Cutting conditions	B018
K	Application	Heavy cutting		N	Application	Finishing to medium cutting
	Grade	T9215			Grade	KS05F
	Chipbreaker Shape				Chipbreaker Shape	
	Cutting conditions	B020			Cutting conditions	B022
S	Application	Finishing to medium cutting	Heavy cutting			
	Grade	AH8015	AH8015			
	Chipbreaker Shape					
	Cutting conditions	B024				

Reference pages: PRDCN: Inserts → **B131**

SRDCN

Screw-on toolholder with 45° approach angle, for positive round inserts

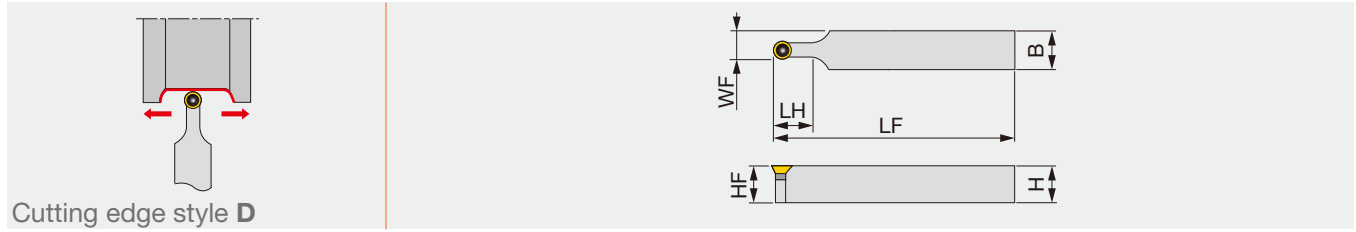

Designation	H	B	LF	LH	HF	WF	Insert
SRDCN2020K06	20	20	125	12	20	13	RC*T0602...
SRDCN2020K08	20	20	125	16	20	14	RC*T0803...
SRDCN2020K10	20	20	125	20.3	25	15	RC*T1003...
SRDCN2525M06	25	25	150	12	25	15.5	RC*T0602...
SRDCN2525M08	25	25	150	16	25	16.5	RC*T0803...
SRDCN2525M10	25	25	150	20.3	25	17.5	RC*T1003...

SPARE PARTS

Designation	Clamping screw	Shim screw	Shim	Wrench 1	Wrench 2
SRDCN2020K06	CSTB-2.5	-	-	-	T-8F
SRDCN2020K08	CSTB-3	-	-	-	T-9F
SRDCN2020K10	CSTB-3.5L	DTS5-3.5	SSR32	P-3.5	T-15F
SRDCN2525M06	CSTB-2.5	-	-	-	T-8F
SRDCN2525M08	CSTB-3	-	-	-	T-9F
SRDCN2525M10	CSTB-3.5L	DTS5-3.5	SSR32	P-3.5	T-15F

INSERT SELECTION

P	Application	Finishing to medium cutting	Heavy cutting	M	Application	Heavy cutting
	Grade	T9215	T9215		Grade	T9215
	Chipbreaker	RS	61		Chipbreaker	61
	Shape				Shape	
	Cutting conditions	B016			Cutting conditions	B018
K	Application	Heavy cutting		N	Application	Finishing to medium cutting
	Grade	T9215			Grade	KS05F
	Chipbreaker	61			Chipbreaker	AL
	Shape				Shape	
	Cutting conditions	B020			Cutting conditions	B022
S	Application	Finishing to medium cutting	Heavy cutting			
	Grade	AH8015	AH8015			
	Chipbreaker	RS	61			
	Shape					
	Cutting conditions	B024				

Reference pages: SRDCN: Inserts → **B131**

Screw-on toolholder with 45° approach angle, for positive round inserts

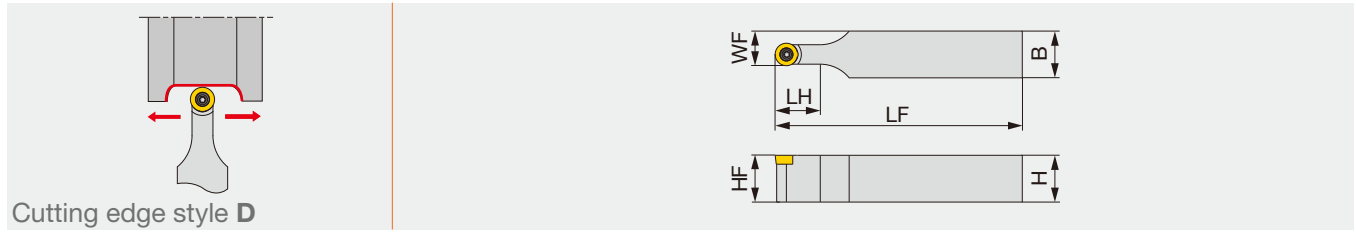

Designation	H	B	LF	LH	HF	WF	Insert	Torque*
SRDCN2525M12-6F	25	25	150	24.1	25	18.5	RCMT1204M0-6RS/-6RM	3

*Torque: Recommended clamping torque (N·m)

SPARE PARTS

Designation	Clamping screw	Lubricant	Wrench
SRDCN2525M12-6F	CSTB-4	M-1000	T-15F

INSERT

RCMT

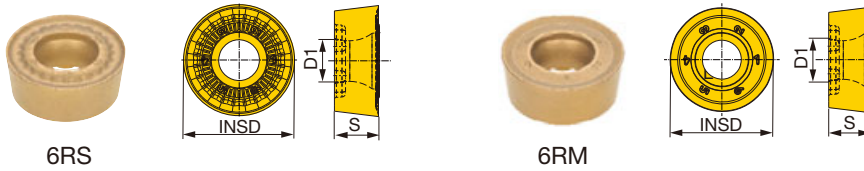

	Steel	Stainless	Cast iron	Non-ferrous	Superalloys	Hard materials
6RS	★	★	☆			
6RM			☆			

★ : First choice
☆ : Second choice

Designation	Coated		Cermet		INSD	S	D1
	T9215	T9225	NS9530				
RCMT1204M0-6RS	●	●	●		12	4.76	5.16
RCMT1204M0-6RM	●	●	●		12	4.76	5.16

● : Line up

TRDCN

Toolholder with carbide clamping plate, with 45° approach angle, for positive round ceramic inserts with V-bottom shape

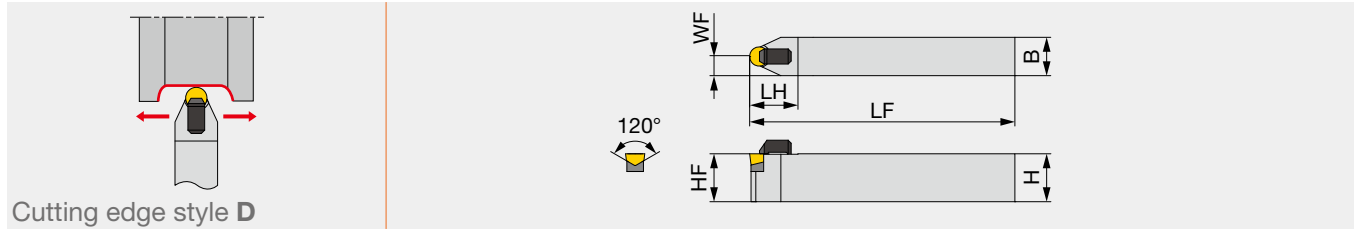

Designation	H	B	LF	LH	HF	WF	RE**	Insert
TRDCN3225P09-120	32	25	170	30	32	12.5	4.76	RCGX090700...
TRDCN3225P12-120	32	25	170	32	32	12.5	6.35	RCGX120700...

**RE: Standard corner radius

Designation	Clamp	Clamp screw	Shim	Shim screw	Wrench 1	Wrench 2
TRDCN3225P09-120	BCL6-20A	BH-M6X1X25	CBRS-09	BH-M2.5X0.45X10	P-4	P-1.5
TRDCN3225P12-120	BCL6	BH-M6X1X25	CBRS-12	BH-M2.5X0.45X10	P-4	P-1.5

INSERT

RCGX-E/T1

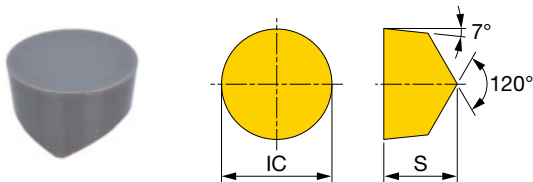

P Steel								
M Stainless								
K Cast iron								
N Non-ferrous								
S Superalloys	★	★						
H Hard materials								

★ : First choice

Designation	Edge prep.*	Ceramic										RE	IC	S	
		TS200	TS300												
RCGX090700-E	E	●	●										-	9.525	7.94
RCGX090700-T1	T1	●	●										-	9.525	7.94
RCGX120700-E	E	●	●										-	12.7	7.94
RCGX120700-T1	T1	●	●										-	12.7	7.94

* Types of cutting edge preparations

● : Line up

E: Low cutting force

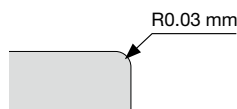

T1: Strong cutting edge

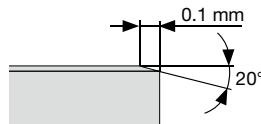

Double-clamp toolholder with 45° approach angle (S-style), for negative square inserts

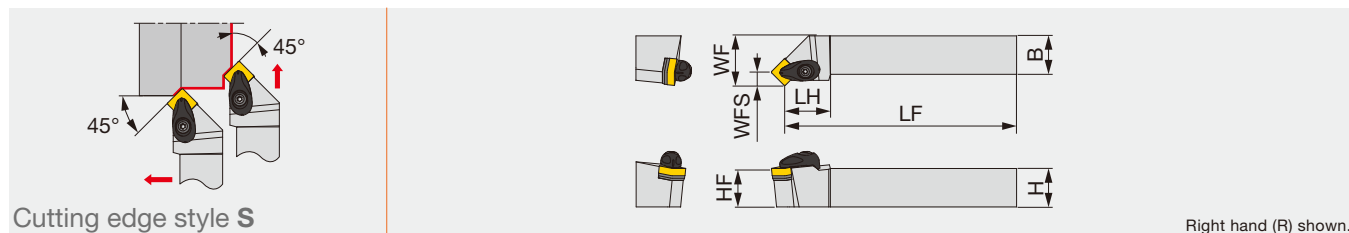

Cutting edge style S

Right hand (R) shown.

Designation	H	B	LF	LH	HF	WF	WFS	RE**	Insert	Torque*
ASSNR/L2020K12-A	20	20	125	30	20	25	8.3	0.8	SN**1204...	3
ASSNR/L2525M12-A	25	25	150	30	25	32	8.3	0.8	SN**1204...	3
ASSNR/L2525M15-A	25	25	150	25	25	32	10.3	1.2	SN**1506...	6.4
ASSNR/L3232P15-A	32	32	170	25	32	40	10.3	1.2	SN**1506...	6.4
ASSNR/L3232P19-A	32	32	170	27.5	32	40	12.5	1.2	SN**1906...	6.4
ASSNR/L4040S19-A	40	40	250	27.5	40	50	12.5	1.2	SN**1906...	6.4

*Torque: Recommended clamping torque (N-m)

**RE: Standard corner radius

SPARE PARTS

Designation	Clamp	Clamp screw	Spring	Spring pin	Shim	Shim screw	Wrench 1	Wrench 2
ASSNR/L**12-A	ACP4S	ACS-5W	BP-7	SP-2.5	ASS422	CSTB-3.5	T-15F	-
ASSNR/L**15-A	ACP5S	ACS-6W	BP-8.8	SP-2.5	ASS533	CSTB-5	-	KEYV-T20
ASSNR/L**19-A	ACP6S	ACS-6W	BP-8.8	SP-2.5	ASS634	CSTB-5	-	KEYV-T20

DSSNR/L

"One-Double" toolholder with 45° approach angle, for negative square inserts

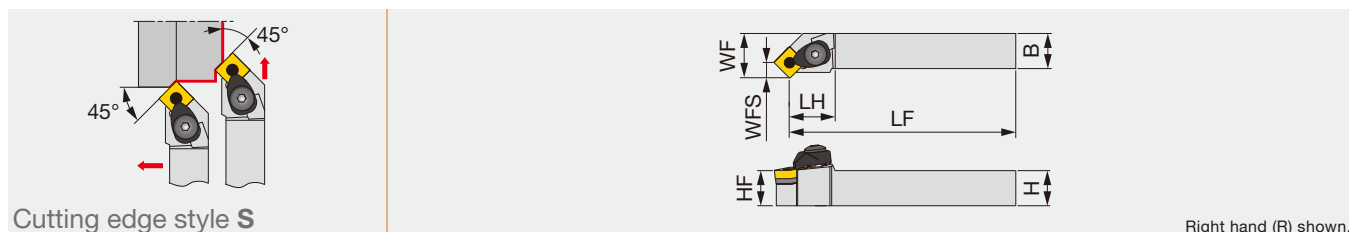

Cutting edge style S

Right hand (R) shown.

Designation	H	B	LF	LH	HF	WF	WFS	RE**	Insert
DSSNR/L2020K12	20	20	125	34.3	20	25	8.3	0.8	SN**1204...
DSSNR/L2525M12	25	25	150	34.3	25	32	8.3	0.8	SN**1204...

Note: Except for TRS, TU, TUS, 57, and 65-type chipbreaker inserts

**RE : Standard corner radius

SPARE PARTS

Designation	Clamp	Lever	Piston	Clamp screw	Shim	Spring	Spring pin	Wrench 1	Wrench 2
DSSNR/L...	DCPM-43	DLCL43	DPIS43	DLCS43	LSS42	BP-10	LSP4	P-3	P-4

Reference pages: ASSNR/L, DSSNR/L: Inserts → **B077 -**, CBN → **B180**, PCD → **B211**

PSSNR/L

Lever-lock toolholder with 45° approach angle, for positive round inserts

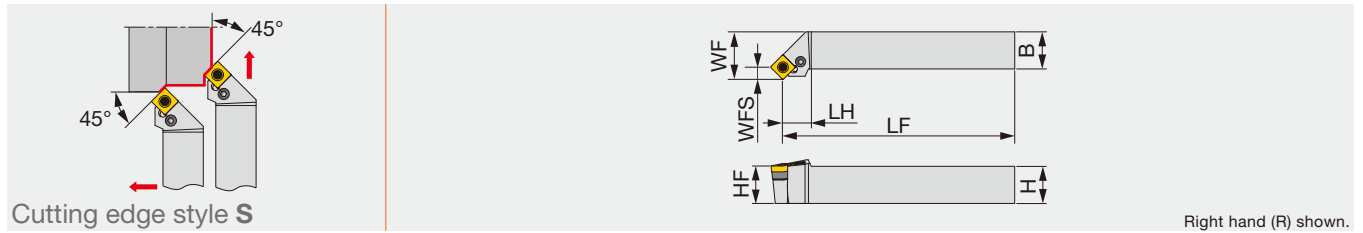

Designation	H	B	LF	LH	HF	WF	WFS	RE**	Insert
PSSNR/L1616	16	16	94	16	16	20	6.1	0.8	SN**0903...
PSSNR/L2020	20	20	116	21	20	25	8.3	0.8	SN**1204...
PSSNR/L2525	25	25	141	21	25	32	8.3	0.8	SN**1204...
PSSNR/L3225	32	25	161	21	32	32	8.3	0.8	SN**1204...
PSSNR/L3232	32	32	157.5	27.5	32	40	12.5	1.2	SN**1906...

**RE: Standard corner radius

SPARE PARTS					
Designation	Shim	Clamping screw	Wrench	Spring pin	Lever
PSSNR/L1616	LSS33	LCS3	P-2.5	LSP3L	LCL3
PSSNR/L2020	LSS42	LCS4	P-3	LSP4	LCL4
PSSNR/L**25	LSS42	LCS4	P-3	LSP4	LCL4
PSSNR/L3232	LSS63	LCS6	P-4	LSP6	LCL6

INSERT SELECTION

Application	Precision finishing	Finishing	Medium cutting	Medium to heavy cutting
	Grade	NS9530	GT9530	T9215
Chipbreaker Shape	TF	TSF	TM	TH
Cutting conditions	B004			

Application	Finishing	Medium cutting	Medium to heavy cutting
	Grade	T6215	AH6225
Chipbreaker Shape	SF	SM	SH
Cutting conditions	B006		

Application	Finishing	Medium cutting	Medium to heavy cutting
	Grade	T515	T515
Chipbreaker Shape	All-round	All-round	All-round
Cutting conditions	B008		

Application	Finishing	Medium cutting
	Grade	DX140
Chipbreaker Shape	DIA	P
Cutting conditions	B010	

Application	Precision finishing	Finishing	Medium cutting
	Grade	BX480	AH8005
Chipbreaker Shape	CBN	HRF	HRM
Cutting conditions	B012		

Reference pages: PSSNR/L: Inserts → B077 -, CBN → B180, PCD → B211



Double-clamp toolholder with 45° approach angle, for negative square ceramic inserts with dimple

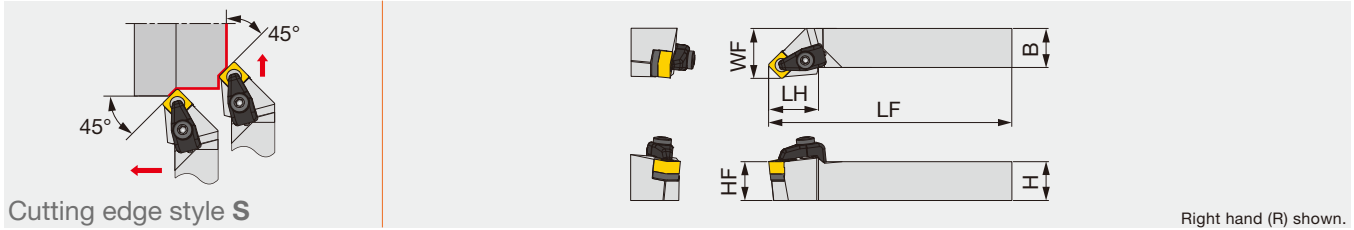

Designation	H	B	LF	LH	HF	WF	RE**	Insert	Torque*
CSSNR/L2525M1207-RD	25	25	150	32	25	32	1.2	SN*D1207...	4

*Torque: Recommended clamping torque (N-m)
**RE : Standard corner radius

SPARE PARTS

Designation	Clamp	Clamp screw	Shim	Shim screw	Spring	Wrench 1	Wrench 2
CSSNR/L2525M1207-RD	CCP4-A	CCS4-A	CS44-A	BH5-10-A	BP-5-A	P-3	P-4

- L
- J
- V
- I
- A
- G
- X
- E
- N
- D
- S**
- K
- F
- Q
- H
- B
- R
- Special

INSERT SELECTION

K	Application	Finishing to medium cutting
	Grade	FX105
	Chipbreaker Shape	
	Cutting conditions	C118

Reference pages: CSSNR/L-RD: Insert → **B085**
Standard cutting conditions → **C118**

Double-clamp toolholder with 45° approach angle, for negative 120° hexagonal ceramic inserts with dimple

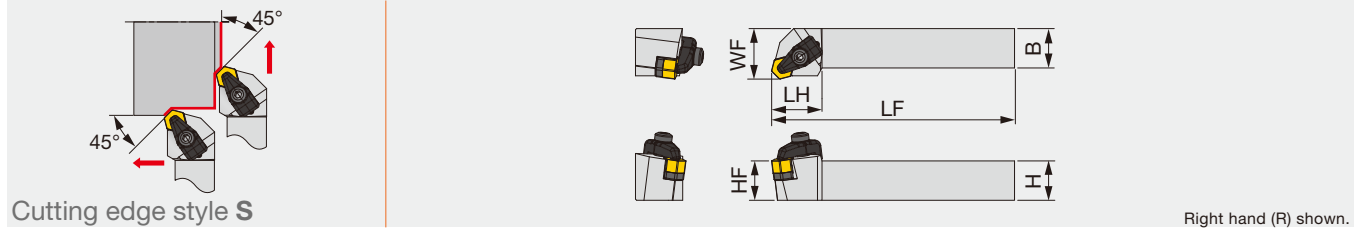







Right hand (R) shown.

Designation	H	B	LF	LH	HF	WF	RE**	Insert	Torque*
CHSNR2525M0507-RD	25	25	150	32	25	32	1.2	HN*D0507...	4

*Torque: Recommended clamping torque (N·m)

**RE: Standard corner radius

SPARE PARTS

Designation							
CHSNR2525M0507-RD	CCP4-A	CCS4-A	CH44-A	BH-40050-A	BP-5-A	P-3	P-4

INSERT SELECTION

K	Application	Finishing to medium cutting
	Grade	FX105
	Chipbreaker Shape	
	Cutting conditions	C118

Reference pages: CHSNR/L-RD: Inserts → **B111**

Standard cutting conditions → **C118**

Double-clamp toolholder with 75° approach angle, for negative square inserts

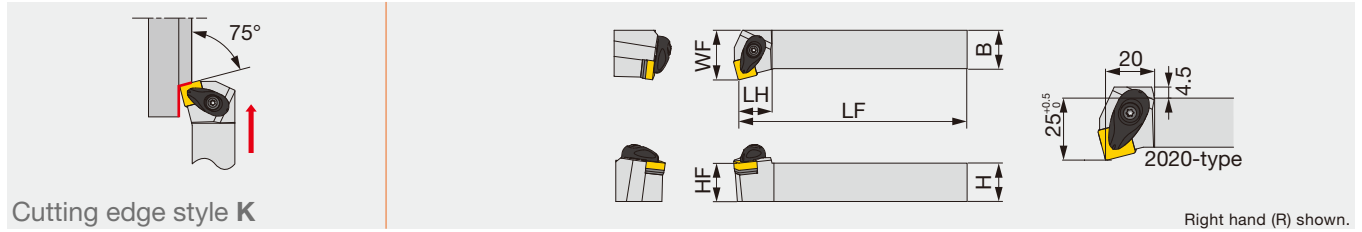

Designation	H	B	LF	LH	HF	WF	RE**	Insert	Torque*
ASKNR/L2020K12-A	20	20	125	20	20	25	0.8	SN**1204...	3
ASKNR/L2525M12-A	25	25	150	22	25	32	0.8	SN**1204...	3

*Torque: Recommended clamping torque (N·m)

**RE : Standard corner radius

SPARE PARTS

Designation	Clamp	Clamp screw	Spring	Spring pin	Shim	Shim screw	Wrench
ASKNR/L**12-A	ACP4S	ACS-5W	BP-7	SP-2.5	ASS422	CSTB-3.5	T-15F

DSKNR/L

"One-Double" toolholder with 75° approach angle, for negative square inserts

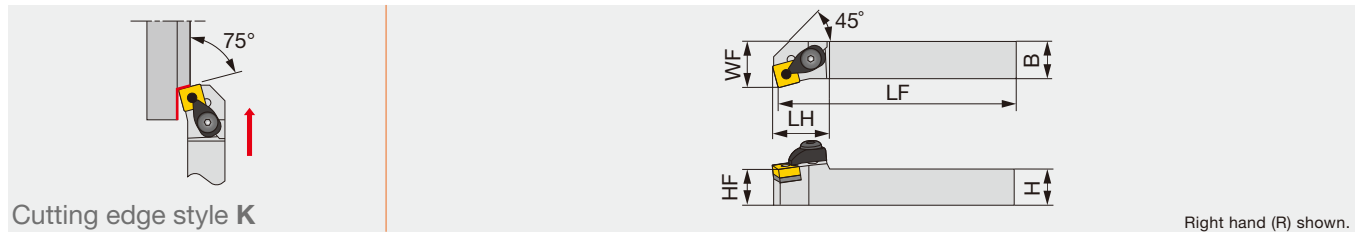

Designation	H	B	LF	LH	HF	WF	RE**	Insert
DSKNR/L2020K12	20	20	125	31	20	25	0.8	SN**1204...
DSKNR/L2525M12	25	25	150	31	25	32	0.8	SN**1204...

Note: Except for TRS, TU, TUS, 57, and 65-type chipbreaker inserts

**RE : Standard corner radius

SPARE PARTS

Designation	Clamp	Lever	Piston	Clamp screw	Shim	Spring	Spring pin	Wrench 1	Wrench 2
DSKNR/L...	DCPM-43	DLCL43	DPIS43	DLCS43	LSS42	BP-10	LSP4	P-3	P-4

PSKNR/L

Lever-lock toolholder with 75° approach angle, for negative square inserts

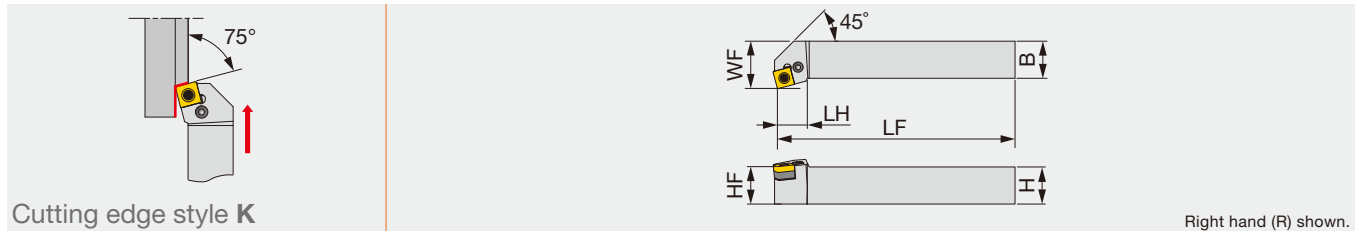

Designation	H	B	LF	LH	HF	WF	RE**	Insert
PSKNR/L1616	16	16	100	17	16	25	0.8	SN**0903...
PSKNR/L2020	20	20	125	22	20	25	0.8	SN**1204...
PSKNR/L2525	25	25	150	22	25	32	0.8	SN**1204...
PSKNR3232	32	32	170	40	32	40	1.2	SN**1906...

**RE : Standard corner radius

SPARE PARTS					
Designation	Shim	Clamping screw	Wrench	Spring pin	Lever
PSKNR/L1616	LSS33	LCS3	P-2.5	LSP3L	LCL3
PSKNR/L2*2*	LSS42	LCS4	P-3	LSP4	LCL4
PSKNR3232	LSS63	LCS6	P-4	LSP6	LCL6

INSERT SELECTION

Application	Precision finishing	Finishing	Medium cutting	Medium to heavy cutting
	Grade	Grade	Grade	Grade
Grade	NS9530	GT9530	T9215	T9215
Chipbreaker Shape	TF	TSF	TM	TH
Image				
Cutting conditions	B004			

Application	Finishing	Medium cutting	Medium to heavy cutting
	Grade	Grade	Grade
Grade	T6215	AH6225	AH6225
Chipbreaker Shape	SF	SM	SH
Image			
Cutting conditions	B006		

Application	Finishing	Medium cutting	Medium to heavy cutting
	Grade	Grade	Grade
Grade	T515	T515	T515
Chipbreaker Shape	All-round	All-round	All-round
Image			
Cutting conditions	B008		

Application	Finishing	Medium cutting
	Grade	Grade
Grade	DX140	TH10
Chipbreaker Shape	DIA	P
Image		
Cutting conditions	B010	

Application	Precision finishing	Finishing	Medium cutting
	Grade	Grade	Grade
Grade	BX480	AH8005	AH8005
Chipbreaker Shape	CBN	HRF	HRM
Image			
Cutting conditions	B012		

Reference pages: PSKNR/L: Inserts → B077 -, CBN → B180, PCD → B211

Grade
Insert
Ext. Toolholder
Int. Toolholder
Threading
Grooving
Miniature tool
Milling cutter
Endmill
Drilling tool
Tooling System
User's Guide
Index



TSKNR/L-F

Toolholder with carbide clamping plate, with 75° approach angle, for negative square ceramic inserts without hole

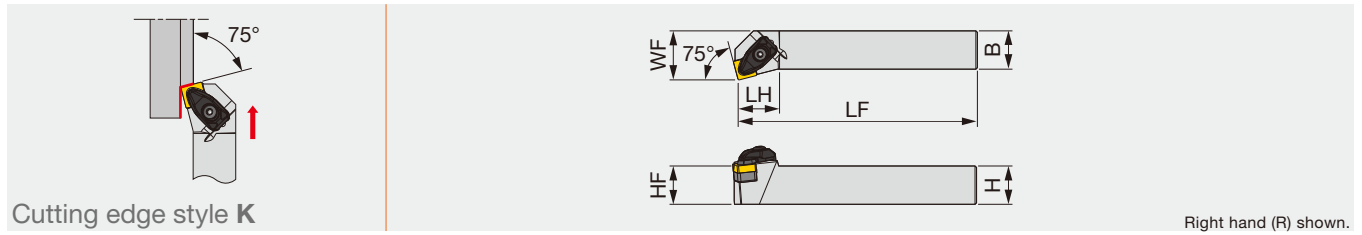

Designation	H	B	LF	LH	HF	WF	RE**	Insert
TSKNR/L2525M1207-F	25	25	150	27	25	32	0.8	SNGN1207...

**RE: Standard corner radius

SPARE PARTS

Designation	Clamp	Clamp screw	Shim	Shim screw	Spring	Wrench 1	Wrench 2
TSKNR/L2525M1207-F	DCLS-4F	DLS-4A	TSS-42	BH-40050-A	DSP-4A	T-15F	P-3

INSERT

SNGN-T1

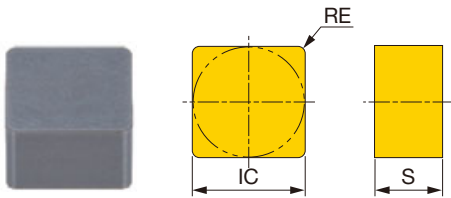

P Steel							
M Stainless							
K Cast iron							
N Non-ferrous							
S Superalloys	★	★					
H Hard materials							

★ : First choice

Designation	Edge prep.*	Ceramic								RE	IC	S	
		TS200	TS300										
SNGN120712-T1	T1	●									1.2	12.7	7.94

* Types of cutting edge preparations

● : Line up

E: Low cutting force

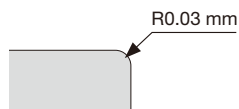

T1: Strong cutting edge

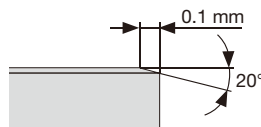

PCFNR/L

Lever-lock type toolholder for facing with 91° approach angle, for negative 80°/70° rhombic inserts

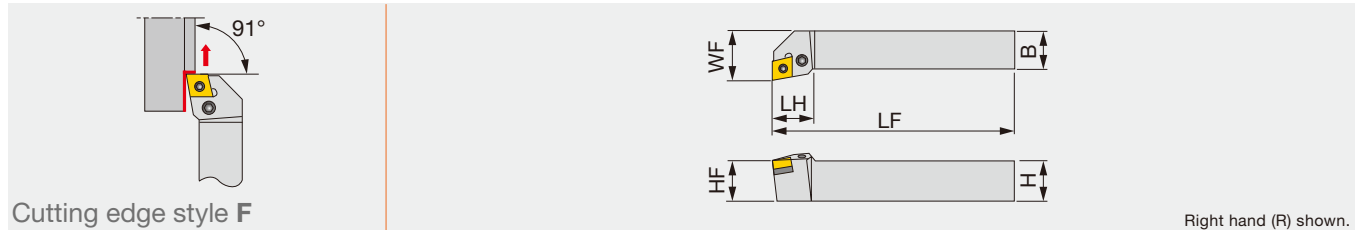

Right hand (R) shown.

Designation	H	B	LF	LH	HF	WF	RE**	Insert
PCFNR/L2020	20	20	125	28	20	25	0.8	CN**/GNGA1204...
PCFNR/L2525	25	25	150	28	25	32	0.8	CN**/GNGA1204...

**RE : Standard corner radius

SPARE PARTS

Designation	Shim	Clamping screw	Wrench	Spring pin	Lever
PCFNR/L...	LSC42 D30	LCS4	P-3	LSP4	LCL4

INSERT SELECTION

P	Application	Precision finishing	Finishing	Medium cutting	Medium to heavy cutting
	Grade	NS9530	GT9530	T9215	T9215
	Chipbreaker shape	TF	TSF	TM	TH
	Cutting conditions	B004			
M	Application	Finishing	Medium cutting	Medium to heavy cutting	
	Grade	T6215	AH6225	AH6225	
	Chipbreaker shape	SF	SM	SH	
	Cutting conditions	B006			
K	Application	Finishing	Medium cutting	Medium to heavy cutting	
	Grade	T515	T515	T515	
	Chipbreaker shape	All-round	All-round	All-round	
	Cutting conditions	B008			
N	Application	Precision finishing	Finishing	Medium cutting	
	Grade	DX120	DX140	TH10	
	Chipbreaker shape	DIA	with rake DIA	P	
	Cutting conditions	B010			
S	Application	Precision finishing	Finishing	Medium cutting	
	Grade	BX470	AH8005	AH8005	
	Chipbreaker shape	CBN	HRF	HRM	
	Cutting conditions	B012			
H	Application	Precision finishing	Finishing		
	Grade	BXA10	BXA20		
	Chipbreaker shape	CBN	CBN		
	Cutting conditions	B014			

Reference pages: PCFNR/L: Inserts → B054 -, CBN → B168 -, B178, PCD → B211



Double-clamp toolholder for facing with 91° approach angle, for negative 60° triangular inserts

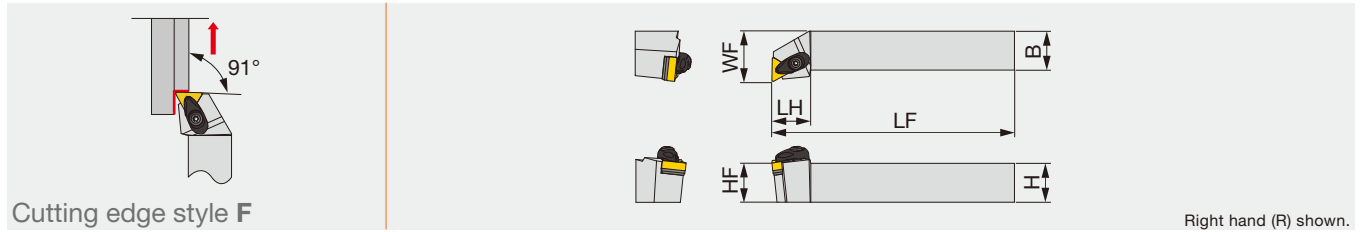

Designation	H	B	LF	LH	HF	WF	RE**	Insert	Torque*
ATFNR/L2020K16-A	20	20	125	25	20	25	0.8	TN**1604...	3
ATFNR/L2525M16-A	25	25	150	25	25	32	0.8	TN**1604...	3
ATFNR/L2525M22-A	25	25	150	29	25	32	0.8	TN**2204...	3

*Torque: Recommended clamping torque (N·m)
 **RE : Standard corner radius

SPARE PARTS

Designation	Clamp	Clamp screw	Spring	Spring pin	Shim	Shim screw	Wrench
ATFNR/L**16-A	ACP3S	ACS-5W	BP-7	SP-2.5	AST322	CSTB-3.5	T-15F
ATFNR/L**22-A	ACP4S	ACS-5W	BP-7	SP-2.5	AST422	CSTB-3.5	T-15F

DTFNR/L

"One-Double" toolholder with 91° approach angle, for negative 60° triangular inserts

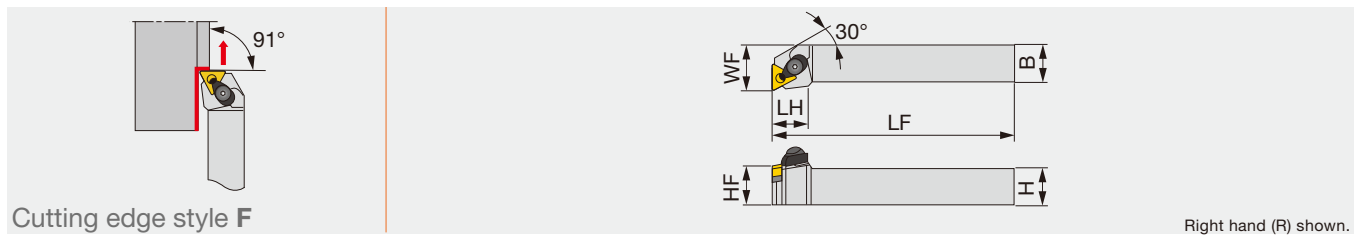

Designation	H	B	LF	LH	HF	WF	RE**	Insert
DTFNR/L2020K16	20	20	125	23	20	25	0.8	TN**1604...
DTFNR/L2525M16	25	25	150	23	25	32	0.8	TN**1604...
DTFNR/L2525M22	25	25	150	31	25	32	0.8	TN**2204...

Note: Except for 57-type chipbreaker inserts
 **RE : Standard corner radius

SPARE PARTS

Designation	Clamp	Lever	Piston	Clamp screw	Shim	Spring	Spring pin	Wrench 1	Wrench 2
DTFNR/L**16	DCPM-33	LCL33	DPIS33	DLCS33	LST317	BP-9	LSP3	P-2.5	P-3
DTFNR/L**22	DCPM-43	DLCL43	DPIS43	DLCS43	LST42	BP-10	LSP4	P-3	P-4

PTFNR/L

Lever-lock toolholder with 91° approach angle, for negative triangular inserts

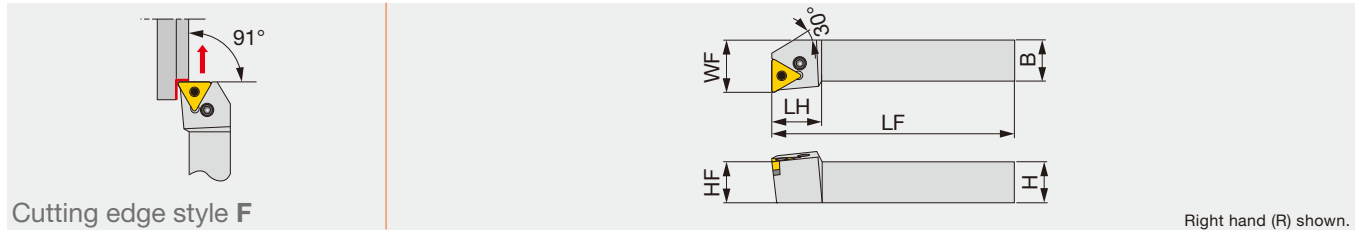

Designation	H	B	LF	LH	HF	WF	RE**	Insert	Torque*
PTFNR/L1616	16	16	100	22	16	20	0.8	TN**1604...	2
PTFNR/L2020K1104	20	20	125	16	20	25	0.8	TN**1104...	2
PTFNR/L2020	20	20	125	22	20	25	0.8	TN**1604...	2
PTFNR/L2525M1104	25	25	150	22	25	32	0.8	TN**1104...	2
PTFNR/L2525M3	25	25	150	22	25	32	0.8	TN**1604...	2
PTFNR/L2525M4	25	25	150	28	25	32	0.8	TN**2204...	3
PTFNR/L3225P4	32	25	170	28	32	32	0.8	TN**2204...	3

*Torque: Recommended clamping torque (N-m)
 **RE : Standard corner radius

SPARE PARTS

Designation	Shim	Clamping screw 1	Clamping screw 2	Wrench	Spring pin	Lever
PTFNR/L1616, 2020	LST317	-	LCS3	P-2.5	LSP3	LCL3
PTFNR/L**1104	-	LCS23A	-	P-2.5	-	LCL23
PTFNR/L2525M3	LST317	-	LCS3	P-2.5	LSP3	LCL3
PTFNR/L**25*4	LST42	-	LCS4	P-3	LSP4	LCL4

INSERT SELECTION

Application	Precision finishing	Finishing	Medium cutting	Medium to heavy cutting
	Grade	NS9530	GT9530	T9215
Chipbreaker shape	TF	TSF	TM	TH
Cutting conditions	B004			

Application	Finishing	Medium cutting
	Grade	T6215
Chipbreaker shape	SF	SM
Cutting conditions	B006	

Application	Finishing	Medium cutting	Medium to heavy cutting
	Grade	T515	T515
Chipbreaker shape	All-round	All-round	All-round
Cutting conditions	B008		

Application	Precision finishing	Finishing	Medium cutting
	Grade	DX120	DX140
Chipbreaker shape	DIA	with rake DIA	P
Cutting conditions	B010		

Application	Precision finishing	Finishing	Medium cutting
	Grade	BX470	AH8005
Chipbreaker shape	CBN	HRF	HRM
Cutting conditions	B012		

Application	Precision finishing	Finishing
	Grade	BXA10
Chipbreaker shape	CBN	CBN
Cutting conditions	B014	

Reference pages: PTFNR/L: Inserts → B087 -, CBN → B182 -, PCD → B212



Screw-on toolholder for roughing with 93° approach angle, for negative tangential inserts

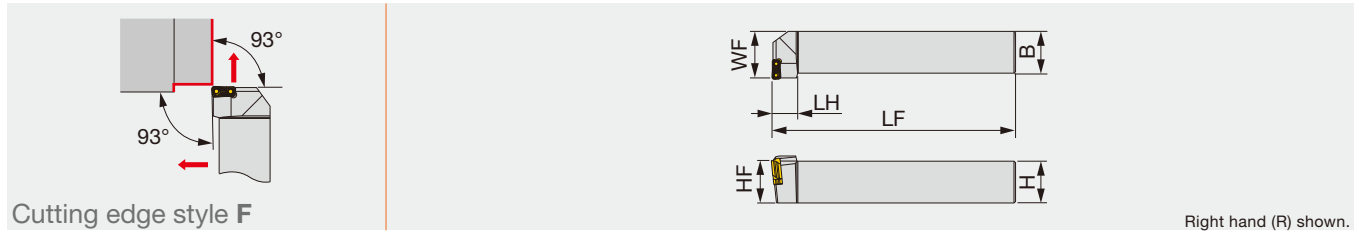

Designation	H	B	LF	LH	HF	WF	Insert
TLFNR/L2525M16	25	25	150	20	25	30	LNMX1606**L/R...
TLFNR/L3232P16	32	32	170	20	32	37	LNMX1606**L/R...

Note: Use right-hand toolholders (R) with left-hand inserts (L); and left-hand toolholders (L) with right-hand inserts (R).

SPARE PARTS

Designation	Clamping screw	Shim	Spring pin	Wrench
TLFNR2525M16	CSTB-4L115-S	TSL16L	PSP-16	KEYV-T15
TLFNL2525M16	CSTB-4L115-S	TSL16R	PSP-16	KEYV-T15
TLFNR3232P16	CSTB-4L115-S	TSL16L	PSP-16	KEYV-T15
TLFNL3232P16	CSTB-4L115-S	TSL16R	PSP-16	KEYV-T15

INSERT

LNMX12/16/24

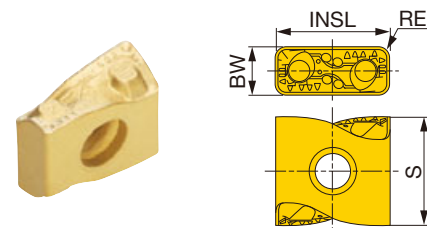

	★	★	★				
P Steel	★	★	★				
M Stainless	☆	☆	☆				
K Cast iron	☆	☆	☆				
N Non-ferrous							
S Superalloys							
H Hard materials							

★ : First choice
☆ : Second choice

Designation	HAND	RE	Coated			BW	INSL	S
			T9115	T9125	AH725			
LNMX120408R-TDR	R	0.8	●	●		4.8	12	11.6
LNMX120408L-TDR	L	0.8	●	●		4.8	12	11.6
LNMX120412R-TDR	R	1.2	●	●		4.8	12	11.6
LNMX120412L-TDR	L	1.2	●	●		4.8	12	11.6
LNMX160608R-TDR	R	0.8	●	●		6.4	16.2	13.5
LNMX160608L-TDR	L	0.8	●	●		6.4	16.2	13.5
LNMX160612R-TDR	R	1.2	●	●		6.4	16.2	13.5
LNMX160612L-TDR	L	1.2	●	●		6.4	16.2	13.5
LNMX160616R-TDR	R	1.6	●	●		6.4	16.2	13.5
LNMX160616L-TDR	L	1.6	●	●		6.4	16.2	13.5
LNMX241016R-TDR	R	1.6	●	●		9.4	24	20.5
LNMX241016L-TDR	L	1.6	●	●		9.4	24	20.5
LNMX241024R-TDR	R	2.4	●	●		9.4	24	20.5
LNMX241024L-TDR	L	2.4	●	●		9.4	24	20.5
LNMX160608R-MDR	R	0.8	●	●		6.4	16.2	13.5
LNMX160608L-MDR	L	0.8	●	●		6.4	16.2	13.5
LNMX160612R-MDR	R	1.2	●	●		6.4	16.2	13.5
LNMX160612L-MDR	L	1.2	●	●		6.4	16.2	13.5
LNMX160608R-TWR	R	0.8	●	●		6.4	16.2	13.5
LNMX160608L-TWR	L	0.8	●	●		6.4	16.2	13.5
LNMX160612R-TWR	R	1.2	●	●		6.4	16.2	13.5
LNMX160612L-TWR	L	1.2	●	●		6.4	16.2	13.5

● : Line up

Reference pages: TLFNR/L: Standard cutting conditions → C119

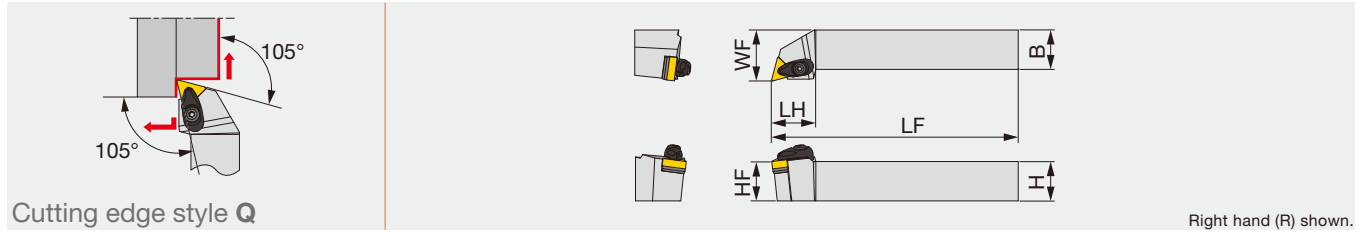

Cutting edge style Q

Right hand (R) shown.

Designation	H	B	LF	LH	HF	WF	RE**	Insert	Torque*
ATQNR/L2020K16-A	20	20	125	28	20	25	0.8	TN**1604...	3
ATQNR/L2525M16-A	25	25	150	28	25	32	0.8	TN**1604...	3

*Torque: Recommended clamping torque (N-m)

**RE : Standard corner radius

SPARE PARTS

Designation	Clamp	Clamp screw	Spring	Spring pin	Shim	Shim screw	Wrench
ATQNR/L**16-A	ACP3S	ACS-5W	BP-7	SP-2.5	AST322	CSTB-3.5	T-15F

INSERT SELECTION

Application	Precision finishing	Finishing	Medium cutting	Medium to heavy cutting
	Grade	NS9530	GT9530	T9215
Chipbreaker shape	TF	TSF	TM	TH
Cutting conditions	B004			

Application	Finishing	Medium cutting
	Grade	T6215
Chipbreaker shape	SF	SM
Cutting conditions	B006	

Application	Finishing	Medium cutting	Medium to heavy cutting
	Grade	T515	T515
Chipbreaker shape	All-round	All-round	All-round
Cutting conditions	B008		

Application	Precision finishing	Finishing	Medium cutting
	Grade	DX120	DX140
Chipbreaker shape	DIA	with rake DIA	P
Cutting conditions	B010		

Application	Precision finishing	Finishing	Medium cutting
	Grade	BX470	AH8005
Chipbreaker shape	CBN	HRF	HRM
Cutting conditions	B012		

Application	Precision finishing	Finishing
	Grade	BXA10
Chipbreaker shape	CBN	CBN
Cutting conditions	B014	

Reference pages: ATQNR/L: Inserts → B087 -, CBN → B182 -, PCD → B212



Double-clamp toolholder with 107.5° approach angle, for negative 55°/45° rhombic inserts

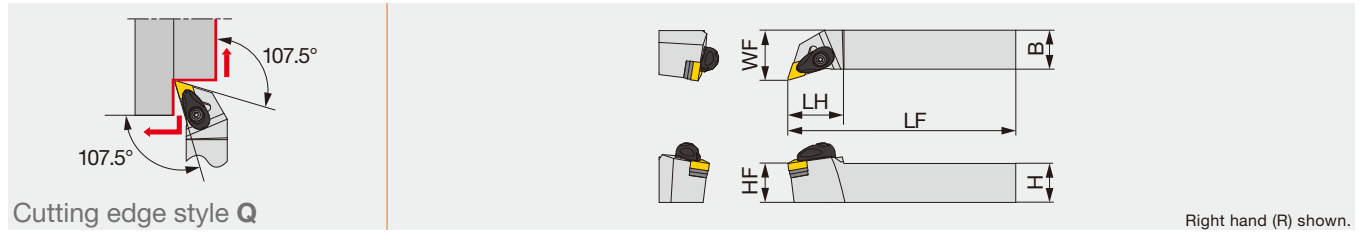

Designation	H	B	LF	LH	HF	WF	RE**	Insert	Torque*
ADQNR/L2020K1104-A	20	20	125	30	20	25	0.8	DN**/FNMG1104...	3
ADQNR/L2020K15-A	20	20	125	32	20	25	0.8	DN**/FNGA1504...	3
ADQNR/L2020K1506-A	20	20	125	32	20	25	0.8	DN**/FNGA1506...	3
ADQNR/L2525M1104-A	25	25	150	30	25	32	0.8	DN**/FNMG1104...	3
ADQNR/L2525M15-A	25	25	150	36	25	32	0.8	DN**/FNGA1504...	3
ADQNR/L2525M1506-A	25	25	150	36	25	32	0.8	DN**/FNGA1506...	3

*Torque: Recommended clamping torque (N·m)
 **RE : Standard corner radius

C-ADQNR/L

Double-clamp toolholder, with 107.5° approach angle, for negative 55°/45° rhombic inserts

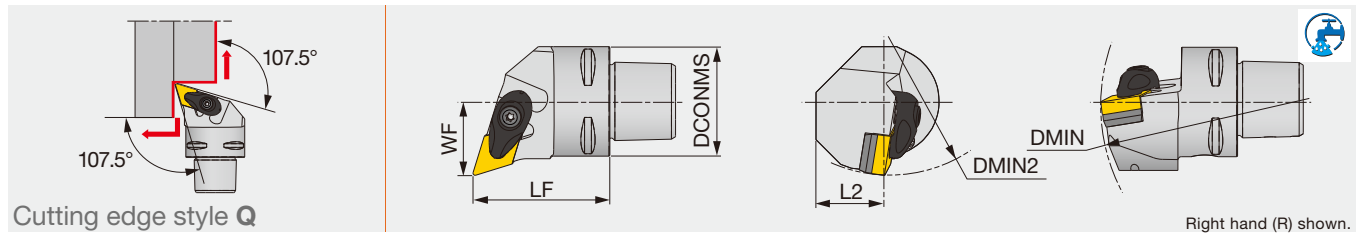

Designation	DCONMS	LF	L2	WF	DMIN	DMIN2	RE	Insert
C3ADQNR/L22040-15N	32	40	20	22	121	85	0.8	DN**/FNGA1504...
C4ADQNR/L27050-15N	40	50	25	27	145	110	0.8	DN**/FNGA1504...

Applicable for 7 MPa coolant

Option: ASD423 (Shim for DN**1506**)

SPARE PARTS

Designation	Clamp	Clamp screw	Spring	Spring pin	Shim	Shim screw	Wrench
ADQNR/L**1104-A	ACP3S-E	ACS-5W	BP-7	SP-2.5	ASD322	CSTB-3.5	T-15F
ADQNR/L**15-A	ACP4S	ACS-5W	BP-7	SP-2.5	ASD432	CSTB-3.5	T-15F
ADQNR/L**1506-A	ACP4S	ACS-5W	BP-7	SP-2.5	ASD423	CSTB-3.5	T-15F
C*ADQNR/L**15N	ACP4S	ACS-5W	BP-7	SP-2.5	ASD432	CSTB-3.5	T-15F

Reference pages: ADQNR/L, C-ADQNR/L: Inserts → B066 -, B075, CBN → B172 -, B176 -, PCD → B211

DDQNR/L

"One-Double" toolholder with 107.5° approach angle, for negative 55°/45° rhombic inserts

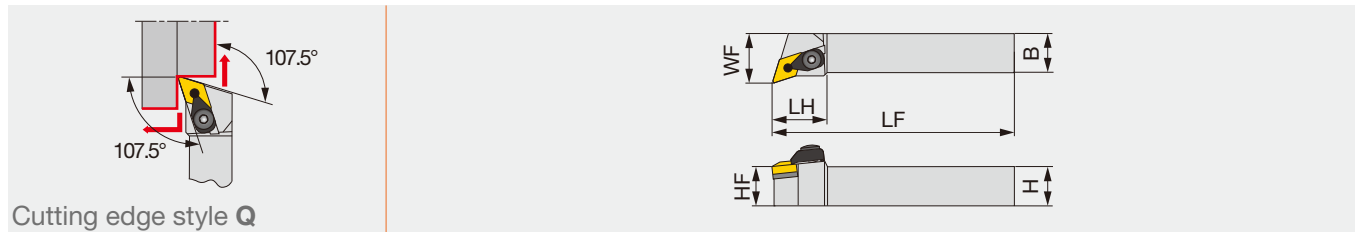

Designation	H	B	LF	LH	HF	WF	RE**	Insert
DDQNR/L2020K15	20	20	125	35	20	25	0.8	DN**/FNGA1504...
DDQNR/L2020K1506	20	20	125	35	20	25	0.8	DN**/FNGA1506...
DDQNR/L2525M15	25	25	150	35	25	32	0.8	DN**/FNGA1504...
DDQNR/L2525M1506	25	25	150	35	25	32	0.8	DN**/FNGA1506...
DDQNR/L3225P15	32	25	170	35	32	32	0.8	DN**/FNGA1504...
DDQNR/L3225P1506	32	25	170	35	32	32	0.8	DN**/FNGA1506...

Note: Except for 57-type chipbreaker inserts

**RE : Standard corner radius

SPARE PARTS

Designation	Clamp	Lever	Piston	Clamp screw	Shim	Spring	Spring pin	Wrench 1	Wrench 2
DDQNR/L**15	DCPM-43	DLCL43	DPIS43	DLCS43	LSD42	BP-10	LSP4	P-3	P-4
DDQNR/L**1506	DCPM-43	DLCL43	DPIS44	DLCS43	LSD42	BP-10	LSP4	P-3	P-4

PDQNR/L

Lever-lock toolholder with 107.5° approach angle, for negative 55°/45° rhombic inserts

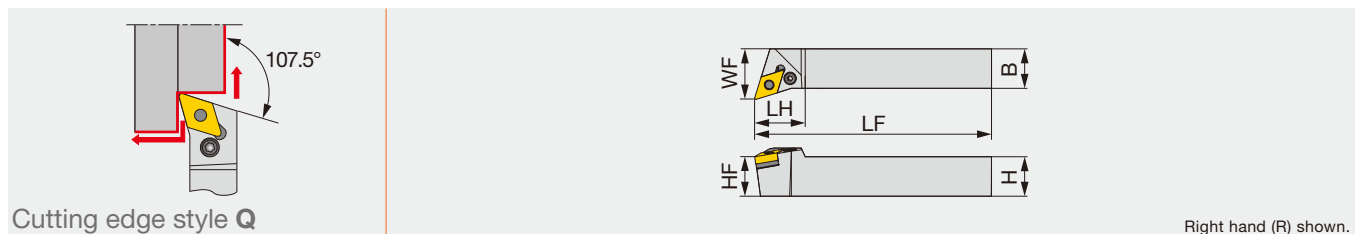

Right hand (R) shown.

Designation	H	B	LF	LH	HF	WF	RE**	Insert
PDQNR/L2525	25	25	150	32	25	32	0.8	DN**/FNGA1504...

**RE : Standard corner radius

SPARE PARTS

Designation	Shim	Clamping screw	Wrench	Spring pin	Lever
PDQNR/L...	LSD42 D30	LCS4	P-3	LSP4	LCL4

INSERT SELECTION

P	Application	Precision finishing	Finishing	Medium cutting	Medium to heavy cutting
	Grade	NS9530	GT9530	T9215	T9215
	Chipbreaker shape	TF	TSF	TM	TH
	Cutting conditions	B004			
M	Application	Finishing	Medium cutting	Medium to heavy cutting	
	Grade	T6215	AH6225	AH6225	
	Chipbreaker shape	SF	SM	SH	
	Cutting conditions	B006			
K	Application	Finishing	Medium cutting	Medium to heavy cutting	
	Grade	T515	T515	T515	
	Chipbreaker shape	All-round	All-round	All-round	
	Cutting conditions	B008			
N	Application	Precision finishing	Finishing	Medium cutting	
	Grade	DX120	DX140	TH10	
	Chipbreaker shape	DIA	DIA with rake	P	
	Cutting conditions	B010			
S	Application	Precision finishing	Finishing	Medium cutting	
	Grade	BX470	AH8005	AH8005	
	Chipbreaker shape	CBN	HRF	HRM	
	Cutting conditions	B012			
H	Application	Precision finishing	Finishing		
	Grade	BXA10	BXA20		
	Chipbreaker shape	CBN	CBN		
	Cutting conditions	B014			

Reference pages: DDQNR/L, PDQNR/L: Inserts → B066 -, B075, CBN → B172 -, B176 -, PCD → B211

TURNING

AVQNR/L

Double-clamp toolholder with 117.5° approach angle, for negative 35°/25° rhombic inserts

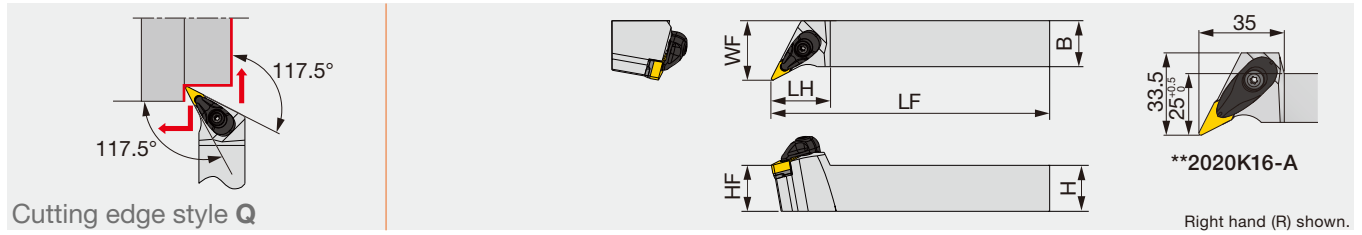

Designation	H	B	LF	LH	HF	WF	RE**	Insert	Torque*
AVQNR/L2020K1204-A	20	20	125	32	20	25	0.8	VN**1204...	3
AVQNR/L2020K16-A	20	20	125	35	20	25	0.8	VN**/YN**1604...	3
AVQNR/L2525M1204-A	25	25	150	32	25	32	0.8	VN**1204...	3
AVQNR/L2525M16-A	25	25	150	35	25	32	0.8	VN**/YN**1604...	3

*Torque: Recommended clamping torque (N-m) **RE: Standard corner radius

C-AVQNR/L

Double-clamp toolholder, with 117.5° approach angle, for negative 35°/25° rhombic inserts

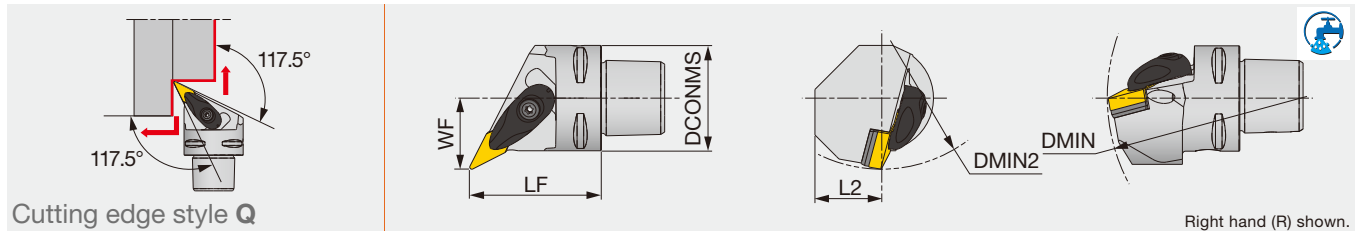

Designation	DCONMS	LF	L2	WF	DMIN	DMIN2	RE	Insert
C4AVQNR/L27050-16N	40	50	25	27	145	110	0.8	VN**/YN**1604...

Applicable for 7 MPa coolant

SPARE PARTS

Designation	Clamp	Clamp screw	Spring	Spring pin	Shim	Shim screw	Wrench
AVQNR/L**1204-A	ACP3L-E	ACS-5W	BP-7	SP-2.5	ASV222	CSTB-3.0	T-15F
AVQNR/L**16-A	ACP3L	ACS-5W	BP-7	SP-2.5	ASV322	CSTB-3.5	T-15F
C4AVQNR/L**16N	ACP3L	ACS-5W	BP-7	SP-2.5	ASV322	CSTB-3.5	T-15F

ISO ETURN

PVQNR/L-Eco

Lever-lock toolholder with 117.5° approach angle, for negative 35° rhombic inserts

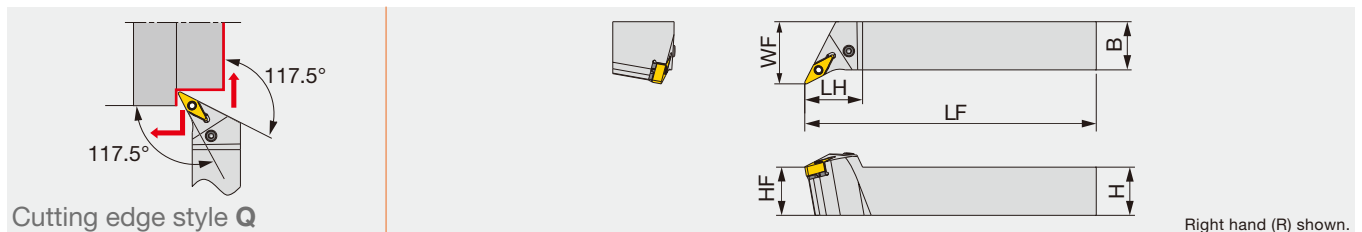

Designation	H	B	LF	LH	HF	WF	RE**	Insert	Torque*
PVQNR/L2020K1204	20	20	125	30	20	25	0.8	VN**1204...	2
PVQNR/L2525M1204	25	25	150	30	25	32	0.8	VN**1204...	2

*Torque: Recommended clamping torque (N-m) **RE: Standard corner radius

SPARE PARTS

Designation	Shim	Clamping screw	Wrench	Spring pin	Lever
PVQNR/L**1204	LSV212	LCS3V	P-2.5	LSP3	LCL3V

Reference pages: AVQNR/L, C-AVQNR/L: Inserts → **B098 -**, B110, CBN → **B186 -**, PCD → **B188**
 PVQNR/L-Eco: Inserts → **B098 -**

Lever lock toolholders – 117.5° approach angle.
For negative 35°/25° rhombic insert. High-pressure coolant capability.

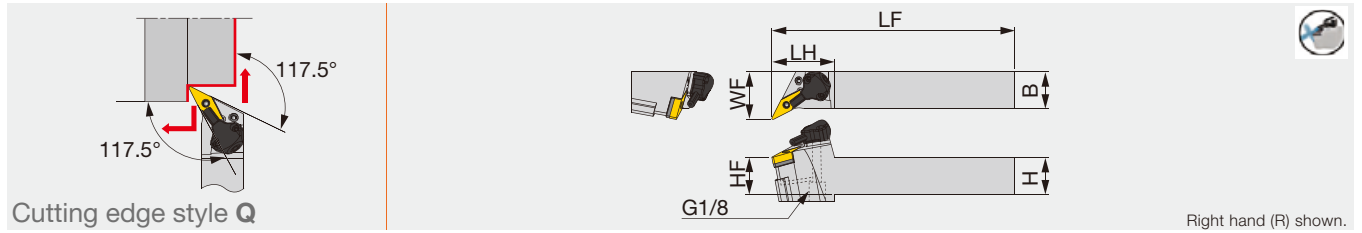

Designation	H	B	LF	LH	HF	WF	RE**	Insert	Torque*
PVQNR/L2020K16-CHP	20	20	125	42.5	20	32	0.8	VN**/YN**1604...	2
PVQNR/L2525M16-CHP	25	25	150	42.5	25	32	0.8	VN**/YN**1604...	2

*Torque: Recommended torque (N·m) for clamping
**RE: Standard corner radius

SPARE PARTS

Designation	Shim	Clamping screw	Wrench 1	Spring pin	Lever
PVQNR/L**16-CHP	LSV317	LCS3V	P-2.5	LSP3	LCL3V

SPARE PARTS

Designation	Coolant unit	Mounting screw	Wrench 2	O-ring	Coolant screw	Wrench 3
PVQNR/L**16-CHP	CU-V-CHP	SRM3	T-8F	OR6.4X0.9N	SRM4X4TL360	P-2

INSERT SELECTION

Application	Precision finishing	Finishing	Medium cutting
	Grade	NS9530	GT9530
Chipbreaker shape	TF	TSF	TM
Cutting conditions	B004		

Application	Finishing	Medium cutting
	Grade	T6215
Chipbreaker shape	SF	SM
Cutting conditions	B006	

Application	Finishing	Medium cutting	Medium to heavy cutting
	Grade	T515	T515
Chipbreaker shape	All-round	All-round	All-round
Cutting conditions	B008		

Application	Precision finishing
	Grade
Chipbreaker shape	DIA
Cutting conditions	B010

Application	Precision finishing	Finishing	Medium cutting
	Grade	BX470	AH8005
Chipbreaker shape	CBN	HRF	HRM
Cutting conditions	B012		

Application	Precision finishing	Finishing
	Grade	BXA10
Chipbreaker shape	CBN	CBN
Cutting conditions	B014	

Reference pages: PVQNR/L-CHP: Inserts → **B098 -**, CBN → **B186 -**, PCD → **B212**
Parts for coolant hose → **C115**

SDQCR/L

Screw-on toolholder with 107.5° approach angle, for positive 55° rhombic inserts

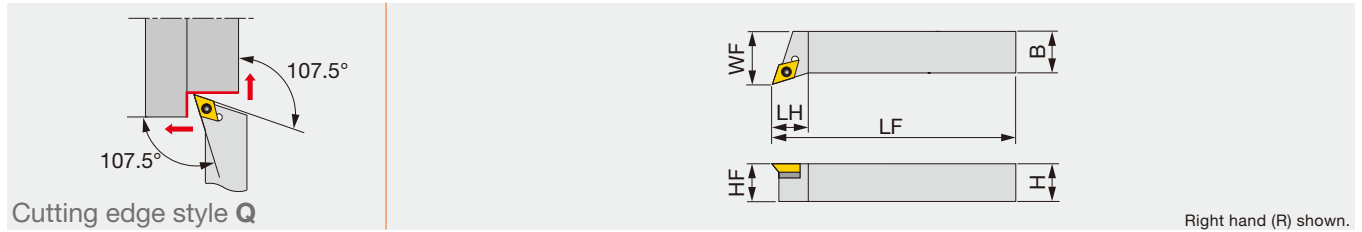

Designation	H	B	LF	LH	HF	WF	RE**	Insert
SDQCR/L2020K11	20	20	125	20.5	20	25	0.8	DC**11T3...
SDQCR2525M11	25	25	150	21.5	25	32	0.8	DC**11T3...

**RE : Standard corner radius

SPARE PARTS

Designation	Clamping screw	Shim screw	Shim	Wrench 1	Wrench 2
SDQCR/L...	CSTB-3.5L	DTS5-3.5	SSD32	P-3.5	T-15F

INSERT SELECTION

P	Application	Finishing	Finishing to medium cutting	Medium cutting
	Grade	NS9530	T9215	T9215
	Chipbreaker shape	PSS	PS	PM
	Cutting conditions	B016		

M	Application	Precision finishing	Finishing	Finishing to medium cutting	Medium cutting
	Grade	GH330	AH6225	AH6225	AH6225
	Chipbreaker shape	W**	PSS	PS	PM
	Cutting conditions	B018			

K	Application	Finishing to medium cutting
	Grade	T515
	Chipbreaker shape	CM
	Cutting conditions	B020

N	Application	Precision finishing	Finishing	Medium cutting
	Grade	DX120	DX140	KS05F
	Chipbreaker shape	DIA	DIA with rake	AL
	Cutting conditions	B022		

S	Application	Finishing	Finishing to medium cutting
	Grade	AH8015	AH8015
	Chipbreaker shape	PSS	PS
	Cutting conditions	B024	

H	Application	Precision finishing	Finishing
	Grade	BXA10	BXA20
	Chipbreaker shape	CBN	CBN
	Cutting conditions	B026	

Reference pages: SDQCR/L: Inserts → B121 -, CBN → B194, PCD → B214

SVQCR/L

Screw-on toolholder with 117.5° approach angle, for positive 35° rhombic inserts

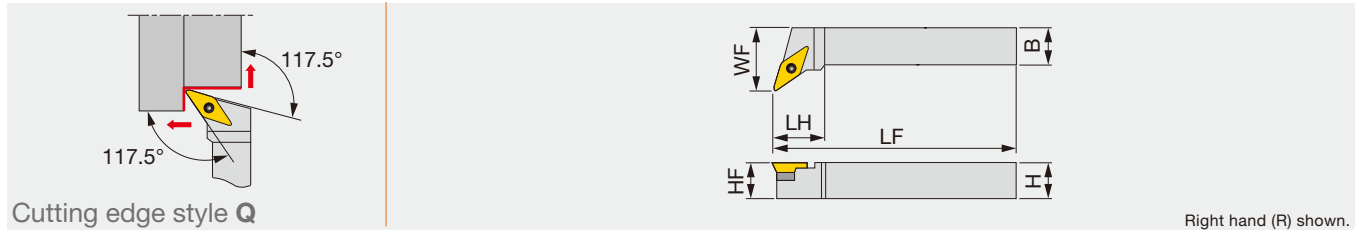

Designation	H	B	LF	LH	HF	WF	RE**	Insert
SVQCR/L2020K16	20	20	125	35	20	27	0.8	VC**1604...
SVQCR/L2525M16	25	25	150	35	25	32	0.8	VC**1604...

**RE : Standard corner radius

SPARE PARTS

Designation	Clamping screw	Shim screw	Shim	Wrench 1	Wrench 2
SVQCR/L...	CSTB-3.5L	DTS5-3.5	SSV32	P-3.5	T-15F

INSERT SELECTION

P	Application	Finishing	Finishing to medium cutting	M	Application	Finishing	Finishing to medium cutting	
	Grade	NS9530	T9215		Grade	AH6225	AH6225	
	Chipbreaker shape	PSS	PS		Chipbreaker shape	PSS	PS	
	Cutting conditions	B016			Cutting conditions	B018		
K	Application	Finishing to medium cutting		N	Application	Precision finishing	Finishing	Medium cutting
	Grade	T515			Grade	DX120	DX140	KS05F
	Chipbreaker shape	CM			Chipbreaker shape	DIA	with rake DIA	AL
	Cutting conditions	B020			Cutting conditions	B022		
S	Application	Finishing	Finishing to medium cutting	H	Application	Precision finishing	Finishing	
	Grade	AH8015	AH8015		Grade	BXA10	BXA20	
	Chipbreaker shape	PSS	PS		Chipbreaker shape	CBN	CBN	
	Cutting conditions	B024			Cutting conditions	B026		

Reference pages: SVQCR/L: Inserts → B152 -, CBN → B209, PCD → B220



Y-PRO SERIES

SYQBR/L

Screw-on toolholder with 122.5° approach angle, for positive 25° rhombic inserts

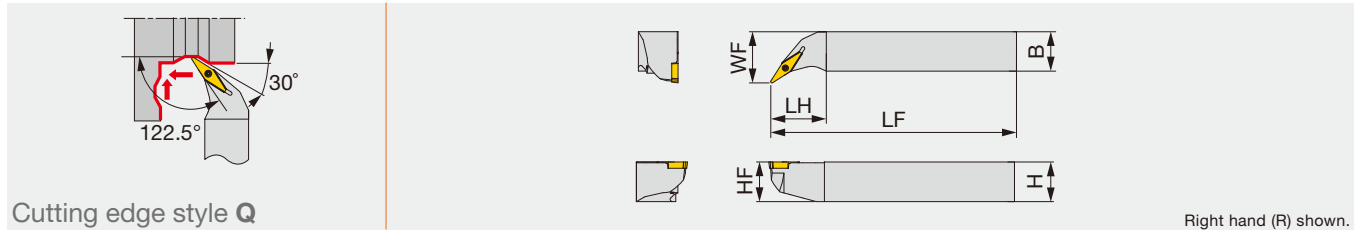

Right hand (R) shown.

Designation	H	B	LF	LH	HF	WF	RE**	Insert
SYQBR/L2020K16	20	20	125	35	20	27	0.8	YWMT16T3...
SYQBR/L2525M16	25	25	150	35	25	32	0.8	YWMT16T3...

**RE : Standard corner radius

SPARE PARTS

Designation	Clamping screw	Wrench
SYQBR/L...	CSTB-2.5L080	T-8F

INSERT SELECTION

Application	Finishing to medium cutting	Application	Finishing to medium cutting	Application	Finishing to medium cutting	Application	Finishing to medium cutting
Grade	T9225	Grade	AH8015	Grade	GT9530	Grade	AH8015
Breaker Shape	ZM	Breaker Shape	ZM	Breaker Shape	ZM	Breaker Shape	ZM
Cutting conditions	B016	Cutting conditions	B018	Cutting conditions	B020	Cutting conditions	B024

SVHCR/L

Screw-on toolholder with 107.5° approach angle, for positive 35° rhombic inserts

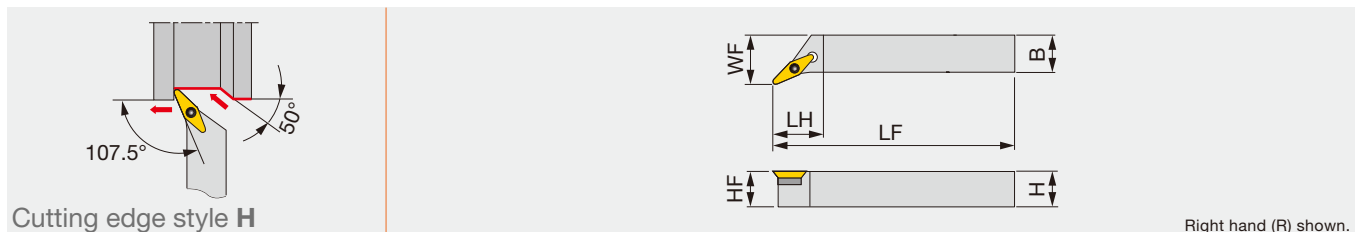

Right hand (R) shown.

Designation	H	B	LF	LH	HF	WF	RE**	Insert
SVHCR/L2525M22	25	25	150	33.8	25	32	0.8	VCG*2205...

**RE : Standard corner radius

SPARE PARTS

Designation	Clamping screw	Shim screw	Shim	Wrench 1	Wrench 2
SVHCR/L2525M22	CSTB-4.5L110P	DTS6-4.5	SSV42	P-4.5	T-15F

INSERT SELECTION

Application	Finishing to medium cutting	Application	Finishing to medium cutting
Grade	KS05F	Grade	KS05F
Chipbreaker Shape	AL	Chipbreaker Shape	AL
Cutting conditions	B020	Cutting conditions	B022
Application	Finishing to medium cutting		
Grade	KS05F		
Chipbreaker Shape	AL		
Cutting conditions	B024		

Reference pages: SYQBR/L: Inserts → [B159](#), SVHCR/L: Inserts → [B153](#)

Screw-on toolholder with 100° approach angle, for positive 25° rhombic inserts

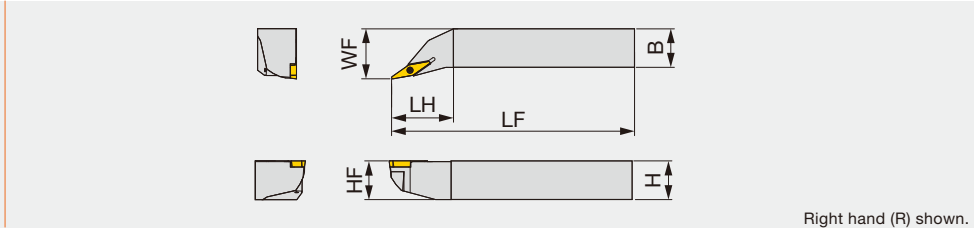
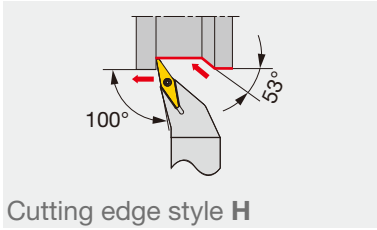

Right hand (R) shown.

Designation	H	B	LF	LH	HF	WF	RE**	Insert
SYHBR/L2020K16	20	20	125	35	20	27	0.8	YWMT16T3...
SYHBR/L2525M16	25	25	150	40	25	32	0.8	YWMT16T3...

**RE : Standard corner radius

SPARE PARTS

Designation	Clamping screw	Wrench
SYHBR/L...	CSTB-2.5L080	T-8F



INSERT SELECTION

P

Application	Finishing to medium cutting
Grade	T9225
Breaker Shape	ZM
Cutting conditions	B016

M

Application	Finishing to medium cutting
Grade	AH8015
Breaker Shape	ZM
Cutting conditions	B018

K

Application	Finishing to medium cutting
Grade	GT9530
Breaker Shape	ZM
Cutting conditions	B020

S

Application	Finishing to medium cutting
Grade	AH8015
Breaker Shape	ZM
Cutting conditions	B024



PCBNR/L

Lever-lock toolholder with 75° approach angle, for negative 80° rhombic inserts

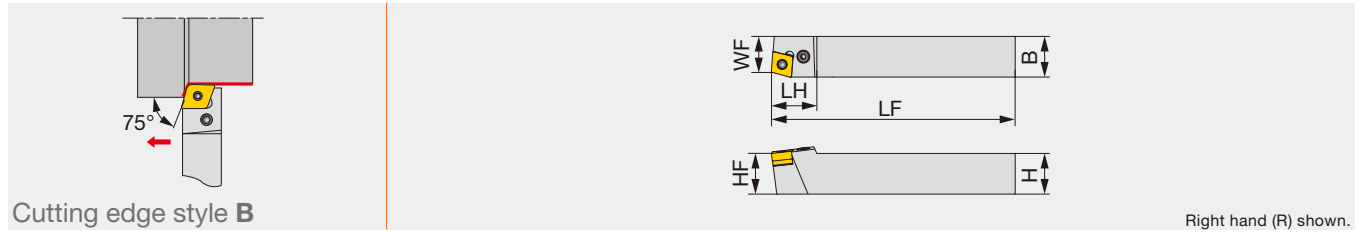

Designation	H	B	LF	LH	HF	WF	RE**	Insert
PCBNR/L2525	25	25	150	28	25	22	0.8	CN**1204...

Note: 100° corner is used.
**RE: Standard corner radius

SPARE PARTS					
Designation	Shim	Clamping screw	Wrench	Spring pin	Lever
PCBNR/L2525	LSC42	LCS4	P-3	LSP4	LCL4

INSERT SELECTION

P	Application	Precision finishing	Finishing	Medium cutting	Medium to heavy cutting
	Grade	NS9530	GT9530	T9215	T9215
Chipbreaker Shape	TF	TSF	TM	TH	
Cutting conditions	B004				

M	Application	Finishing	Medium cutting	Medium to heavy cutting
	Grade	T6215	AH6225	AH6225
Chipbreaker shape	SF	SM	SH	
Cutting conditions	B006			

K	Application	Finishing	Medium cutting	Medium to heavy cutting
	Grade	T515	T515	T515
Chipbreaker Shape	All-round	All-round	All-round	
Cutting conditions	B008			

N	Application	Medium cutting
	Grade	TH10
Chipbreaker Shape	P	
Cutting conditions	B010	

S	Application	Finishing	Medium cutting
	Grade	AH8005	AH8005
Chipbreaker Shape	HRF	HRM	
Cutting conditions	B012		

Reference pages: PCBNR/L: Inserts → B054 -, CBN → B168 -, PCD → B211

Double-clamp toolholder with 75° approach angle, for negative square inserts

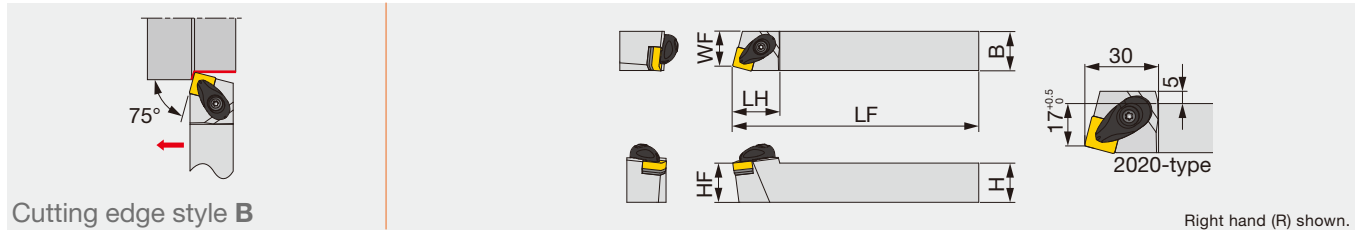

Right hand (R) shown.

Designation	H	B	LF	LH	HF	WF	RE**	Insert	Torque*
ASBNR/L2020K12-A	20	20	125	30	20	17	0.8	SN**1204...	3
ASBNR/L2525M12-A	25	25	150	30	25	22	0.8	SN**1204...	3
ASBNR/L2525M15-A	25	25	150	42.5	25	22	1.2	SN**1506...	6.4
ASBNR/L3232P15-A	32	32	170	42.5	32	27	1.2	SN**1506...	6.4
ASBNR/L3232P19-A	32	32	170	47.5	32	27	1.2	SN**1906...	6.4
ASBNR/L4040S19-A	40	40	250	47.5	40	35	1.2	SN**1906...	6.4

*Torque: Recommended clamping torque (N·m)

**RE: Standard corner radius

SPARE PARTS

Designation	Clamp	Clamp screw	Spring	Spring pin	Shim	Shim screw	Wrench 1	Wrench 2
ASBNR/L**12-A	ACP4S	ACS-5W	BP-7	SP-2.5	ASS422	CSTB-3.5	T-15F	-
ASBNR/L**15-A	ACP5S	ACS-6W	BP-8.8	SP-2.5	ASS533	CSTB-5	-	KEYV-T20
ASBNR/L**19-A	ACP6S	ACS-6W	BP-8.8	SP-2.5	ASS634	CSTB-5	-	KEYV-T20

INSERT SELECTION

Application	Precision finishing	Finishing	Medium cutting	Medium to heavy cutting
	Grade	Grade	Grade	Grade
	NS9530	GT9530	T9215	T9215
Chipbreaker Shape	TF	TSF	TM	TH
Images				
Cutting conditions	B004			

Application	Finishing	Medium cutting	Medium to heavy cutting
	Grade	Grade	Grade
	T6215	AH6225	AH6225
Chipbreaker Shape	SF	SM	SH
Images			
Cutting conditions	B006		

Application	Finishing	Medium cutting	Medium to heavy cutting
	Grade	Grade	Grade
	T515	T515	T515
Chipbreaker Shape	All-round	All-round	All-round
Images			
Cutting conditions	B008		

Application	Finishing	Medium cutting
	Grade	Grade
	DX140	TH10
Chipbreaker Shape	DIA	P
Images		
Cutting conditions	B010	

Application	Precision finishing	Finishing	Medium cutting
	Grade	Grade	Grade
	BX480	AH8005	AH8005
Chipbreaker Shape	CBN	HRF	HRM
Images			
Cutting conditions	B012		

Reference pages: ASBNR/L: Inserts → B075 -, B077 -, CBN → B180, B182, PCD → B211



DSBNR/L

"One-Double" toolholder with 75° approach angle, for negative square inserts

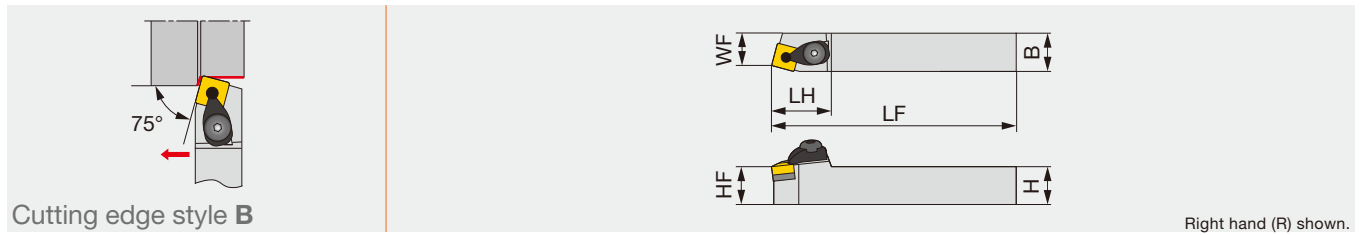

Designation	H	B	LF	LH	HF	WF	RE**	Insert
DSBNR/L2020K12	20	20	125	35	20	17	0.8	SN**1204...
DSBNR/L2525M12	25	25	150	35	25	22	0.8	SN**1204...

Note: Except for TRS, TU, TUS, 57, and 65-type chipbreaker inserts
**RE: Standard corner radius

SPARE PARTS									
Designation	Clamp	Lever	Piston	Clamp screw	Shim	Spring	Spring pin	Wrench 1	Wrench 2
DSBNR/L...	DCPM-43	DLCL43	DPIS43	DLCS43	LSS42	BP-10	LSP4	P-3	P-4

PSBNR/L

Lever-lock toolholder with 75° approach angle, for negative square inserts

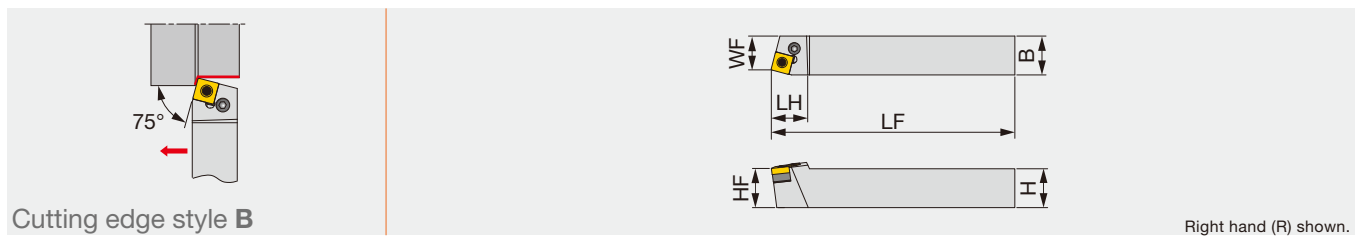

Designation	H	B	LF	LH	HF	WF	RE**	Insert
PSBNR/L1616	16	16	100	22	16	13	0.8	SN**0903...
PSBNR/L2020	20	20	125	28	20	17	0.8	SN**1204...
PSBNR/L2525	25	25	150	24	25	22	0.8	SN**1204...
PSBNR/L3232	32	32	170	40	32	27	1.2	SN**1906...

**RE: Standard corner radius

SPARE PARTS					
Designation	Shim	Clamping screw	Wrench	Spring pin	Lever
PSBNR/L1616	LSS33	LCS3	P-2.5	LSP3L	LCL3
PSBNR/L2*2*	LSS42	LCS4	P-3	LSP4	LCL4
PSBNR/L3232	LSS63	LCS6	P-4	LSP6	LCL6

INSERT SELECTION

P	Application	Precision finishing	Finishing	Medium cutting	Medium to heavy cutting	M	Application	Finishing	Medium cutting	Medium to heavy cutting
	Grade	NS9530	GT9530	T9215	T9215		Grade	T6215	AH6225	AH6225
	Chipbreaker Shape	TF	TSF	TM	TH		Chipbreaker Shape	SF	SM	SH
	Cutting conditions	B004					Cutting conditions	B006		
K	Application	Finishing	Medium cutting	Medium to heavy cutting	N	Application	Finishing	Medium cutting		
	Grade	T515	T515	T515		Grade	DX140	TH10		
	Chipbreaker Shape	All-round	All-round	All-round		Chipbreaker Shape	DIA	P		
	Cutting conditions	B008				Cutting conditions	B010			
S	Application	Precision finishing	Finishing	Medium cutting	N	Application	Finishing	Medium cutting		
	Grade	BX480	AH8005	AH8005		Grade	DX140	TH10		
	Chipbreaker Shape	CBN	HRF	HRM		Chipbreaker Shape	DIA	P		
	Cutting conditions	B012				Cutting conditions	B010			

Reference pages: DSBNR/L, PSBNR/L: Inserts → **B077 -**, CBN → **B180 -**, **B182 -**, PCD → **B211**

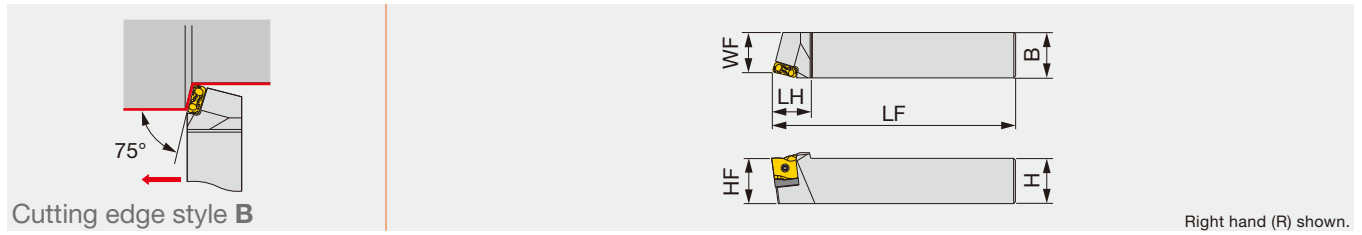

Designation	H	B	LF	LH	HF	WF	Insert
TLBNR/L4040R24	40	40	200	35	40	35	LNMX2410**R/L...

SPARE PARTS

Designation	Clamping screw	Shim	Spring pin	Wrench
TLBNR4040R24	CSTB-5L163-S	TSL24R	PSP-16	KEYV-T20
TLBNL4040R24	CSTB-5L163-S	TSL24L	PSP-16	KEYV-T20

INSERT
LNMX12/16/24

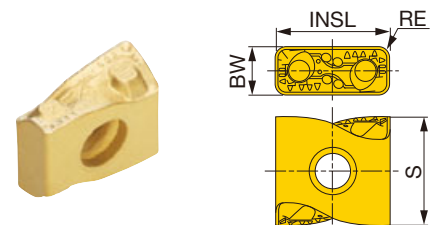

P Steel	★	★	★						
M Stainless	☆		☆						
K Cast iron	☆	☆	☆						
N Non-ferrous									
S Superalloys									
H Hard materials									

★ : First choice
☆ : Second choice

Designation	HAND	RE	Coated			BW	INSL	S
			T9115	T9125	AH725			
LNMX120408R-TDR	R	0.8	●	●		4.8	12	11.6
LNMX120408L-TDR	L	0.8	●	●		4.8	12	11.6
LNMX120412R-TDR	R	1.2	●	●		4.8	12	11.6
LNMX120412L-TDR	L	1.2	●	●		4.8	12	11.6
LNMX160608R-TDR	R	0.8	●	●		6.4	16.2	13.5
LNMX160608L-TDR	L	0.8	●	●		6.4	16.2	13.5
LNMX160612R-TDR	R	1.2	●	●		6.4	16.2	13.5
LNMX160612L-TDR	L	1.2	●	●		6.4	16.2	13.5
LNMX160616R-TDR	R	1.6	●	●		6.4	16.2	13.5
LNMX160616L-TDR	L	1.6	●	●		6.4	16.2	13.5
LNMX241016R-TDR	R	1.6	●	●		9.4	24	20.5
LNMX241016L-TDR	L	1.6	●	●		9.4	24	20.5
LNMX241024R-TDR	R	2.4	●	●		9.4	24	20.5
LNMX241024L-TDR	L	2.4	●	●		9.4	24	20.5
LNMX160608R-MDR	R	0.8	●	●		6.4	16.2	13.5
LNMX160608L-MDR	L	0.8	●	●		6.4	16.2	13.5
LNMX160612R-MDR	R	1.2	●	●		6.4	16.2	13.5
LNMX160612L-MDR	L	1.2	●	●		6.4	16.2	13.5
LNMX160608R-TWR	R	0.8	●	●		6.4	16.2	13.5
LNMX160608L-TWR	L	0.8	●	●		6.4	16.2	13.5
LNMX160612R-TWR	R	1.2	●	●		6.4	16.2	13.5
LNMX160612L-TWR	L	1.2	●	●		6.4	16.2	13.5

● : Line up

Reference pages: Standard cutting conditions → **C119**

Grade **A**
 Insert **B**
 Ext. Toolholder **C**
 Int. Toolholder **D**
 Threading **E**
 Grooving **F**
 Miniature tool **G**
 Milling cutter **H**
 Endmill **I**
 Drilling tool **J**
 Tooling System **K**
 User's Guide **L**
 Index **M**

HSRNR/L

Retract-pin toolholder with 75° approach angle, for negative square inserts

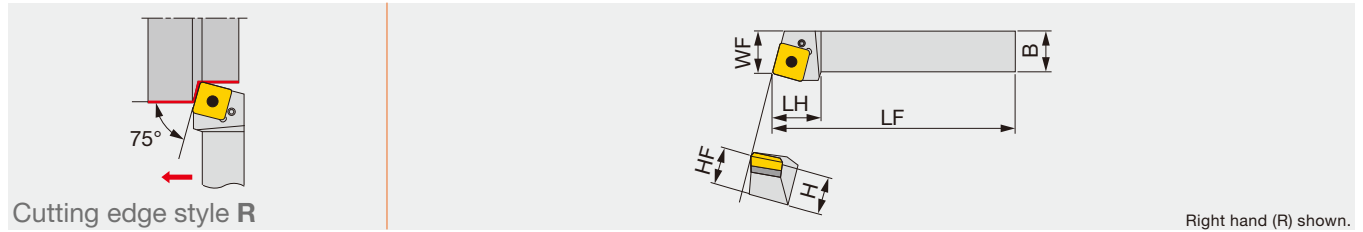

Right hand (R) shown.

Designation	H	B	LF	LH	HF	WF	RE**	Insert
HSRNR/L4040R	40	40	200	50	40	43	1.6	SNMM3109...
HSRNR/L5050S	50	50	250	60	50	53	1.6	SNMM3109...

**RE: Standard corner radius

SPARE PARTS

Designation	Pin	Clamping screw	Shim	Wrench
HSRNR/L...	SW99	LS-8	NAS-04	P-4

INSERT SELECTION

P	Application	Heavy cutting
	Grade	T9225
	Chipbreaker Shape	65 
	Cutting conditions	B004

Reference pages: HSRNR/L: Inserts → **B083**

Double-clamp toolholder, with 50° approach angle, for negative 80°/70° rhombic inserts

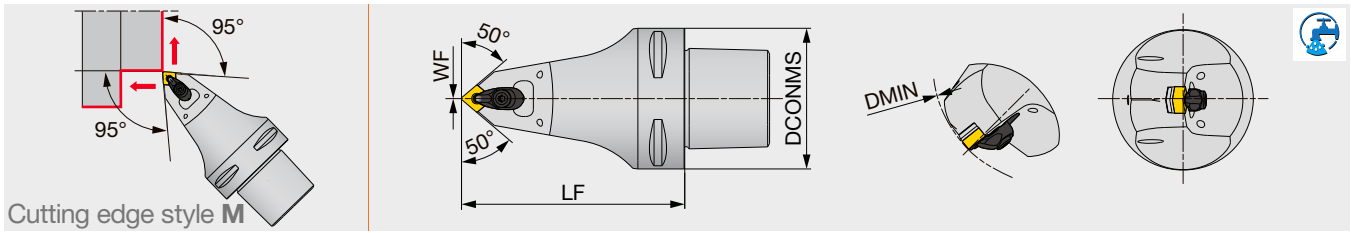

Designation	DCONMS	LF	WF	DMIN	RE**	Insert
C6ACMNN00100-0904N	63	100	0	110	0.8	CN**/GNMG0904...
C6ACMNN00140-0904N	63	140	0	110	0.8	CN**/GNMG0904...

**RE: The holder measurements are true with this insert radius
Applicable for 7 MPa coolant

SPARE PARTS

Designation	Clamp	Clamp screw	Shim	Shim screw	Spring	Spring pin	Wrench
C6ACMNN001*-0904N	ACP3S-E	ACS-5W	ASC322	CSTB-3.5	BP-7	SP-2.5	T-15F

INSERT SELECTION

Application	Precision finishing	Finishing	Medium cutting	Medium to heavy cutting
	Grade	NS9530	GT9530	T9215
Chipbreaker shape	TF	TSF	TM	TH
Cutting conditions	B004			

Application	Finishing	Medium cutting	Medium to heavy cutting
	Grade	T6215	AH6225
Chipbreaker shape	SF	SM	SH
Cutting conditions	B006		

Application	Finishing	Medium cutting	Medium to heavy cutting
	Grade	T515	T515
Chipbreaker shape	All-round	All-round	All-round
Cutting conditions	B008		

Application	Precision finishing	Finishing	Medium cutting
	Grade	DX120	DX140
Chipbreaker shape	DIA	with rake DIA	P
Cutting conditions	B010		

Application	Precision finishing	Finishing	Medium cutting
	Grade	BX470	AH8005
Chipbreaker shape	CBN	HRF	HRM
Cutting conditions	B012		

Application	Precision finishing	Finishing
	Grade	BXA10
Chipbreaker shape	CBN	CBN
Cutting conditions	B014	

Reference pages: C-ACMNN: Inserts → **B054, B075**, CBN → **B168**
Parts for coolant hose → **C115**



Lever lock toolholder with TungCap connection.
For negative 80°/70° rhombic insert. High-pressure coolant capability.

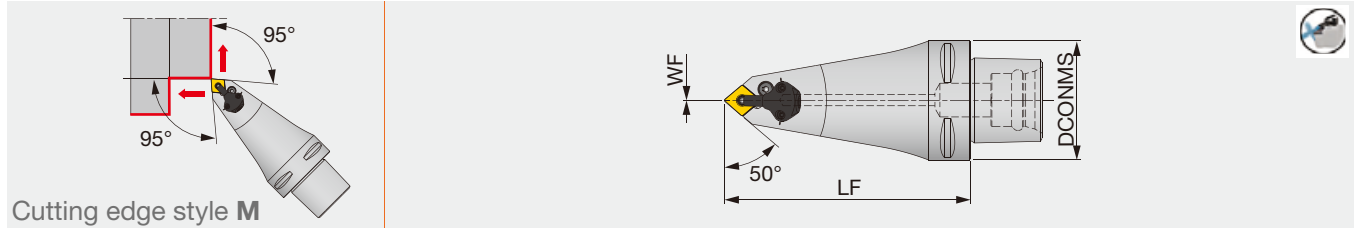

Designation	DCONMS	LF	WF	RE**	Insert	Torque*
C6PCMNN00130-12-CHP	63	130	0	0.8	CN**/GNGA1204...	3

*Torque: Recommended torque (N·m) for clamping
Applicable for 14 MPa pressure coolant
**RE: Standard corner radius

For external turning only.

SPARE PARTS

Designation	Shim	Clamping screw	Wrench 1	Spring pin	Lever
C6PCMNN00130-12-CHP	LSC42	LCS4	P-3	LSP4	LCL4

SPARE PARTS

Designation	Coolant unit	Mounting screw	Wrench 2	O-ring
C6PCMNN00130-12-CHP	CU-CW-CHP	SRM3	T-8F	OR6.4X0.9N

INSERT SELECTION

Application	Precision finishing	Finishing	Medium cutting	Medium to heavy cutting
	Grade	NS9530	GT9530	T9215
Chipbreaker shape	TF	TSF	TM	TH
Cutting conditions	B004			

Application	Finishing	Medium cutting	Medium to heavy cutting
	Grade	T6215	AH6225
Chipbreaker shape	SF	SM	SH
Cutting conditions	B006		

Application	Finishing	Medium cutting	Medium to heavy cutting
	Grade	T515	T515
Chipbreaker shape	All-round	All-round	All-round
Cutting conditions	B008		

Application	Precision finishing	Finishing	Medium cutting
	Grade	DX120	DX140
Chipbreaker shape	DIA	with rake DIA	P
Cutting conditions	B010		

Application	Precision finishing	Finishing	Medium cutting
	Grade	BX470	AH8005
Chipbreaker shape	CBN	HRF	HRM
Cutting conditions	B012		

Application	Precision finishing	Finishing
	Grade	BXA10
Chipbreaker shape	CBN	CBN
Cutting conditions	B014	

Reference pages: C-PCMNN-CHP: Inserts → **B054**, CBN → **B168 -**, PCD → **B211**
Parts for coolant hose → **C115**

Lever lock toolholder with TungCap connection.
For negative 55°/45° rhombic insert. High-pressure coolant capability.

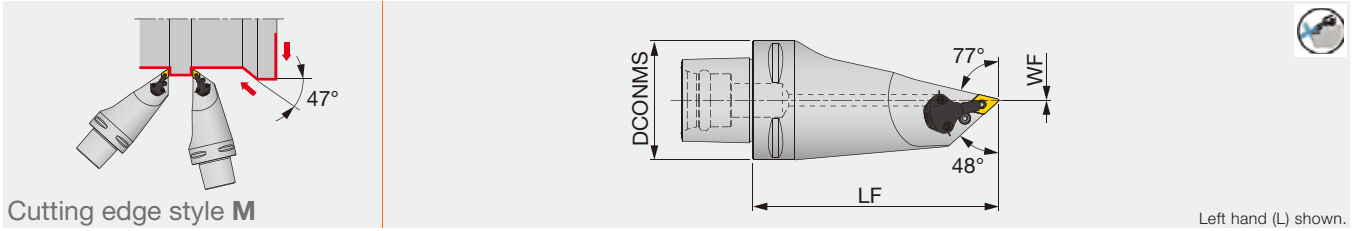

Designation	DCONMS	LF	WF	RE **	Insert	Torque*
C6PDMNL00130-1104-CHP	63	130	0	0.8	DN**/FNMG1104...	2

*Torque: Recommended torque (N-m) for clamping
Applicable for 14 MPa pressure coolant
**RE: Standard corner radius

For external turning only.

SPARE PARTS

Designation	Shim	Clamping screw	Wrench 1	Spring pin	Lever
C6PDMNL00130-1104-CHP	ELSD32	LCS3	P-2.5	LSP3	LCL33L

SPARE PARTS

Designation	Coolant unit	Mounting screw	Wrench 2	O-ring
C6PDMNL00130-1104-CHP	CU-D-CHP	SRM3	T-8F	OR6.4X0.9N

INSERT SELECTION

Application	Finishing	Medium cutting
	Grade	T9215
Chipbreaker shape	TSF	TM
Cutting conditions	B004	

Application	Finishing	Medium cutting
	Grade	AH6225
Chipbreaker shape	SS	SM
Cutting conditions	B006	

Application	Medium cutting
Grade	T515
Chipbreaker shape	TM
Cutting conditions	B008

Reference pages: C-PDMNL-CHP: Inserts → **B066 - , B075**, CBN → **B172**
Parts for coolant hose → **C115**

Double-clamp toolholder with 62.5° approach angle, for negative 55°/45° rhombic inserts

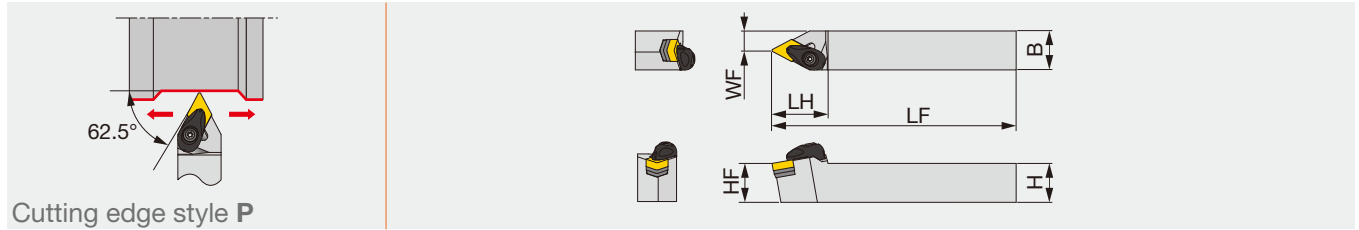

Designation	H	B	LF	LH	HF	WF	RE**	Insert	Torque*
ADPNN2020K15-A	20	20	125	36	20	7.5	0.8	DN**/FNGA1504...	3
ADPNN2525M15-A	25	25	150	36	25	12.5	0.8	DN**/FNGA1504...	3

*Torque: Recommended clamping torque (N-m)
**RE: Standard corner radius

SPARE PARTS

Designation	Clamp	Clamp screw	Spring	Spring pin	Shim	Shim screw	Wrench
ADPNN**15-A	ACP4S	ACS-5W	BP-7	SP-2.5	ASD432	CSTB-3.5	T-15F

PDPNN

Lever-lock toolholder with 62.5° approach angle, for negative 55°/45° rhombic inserts

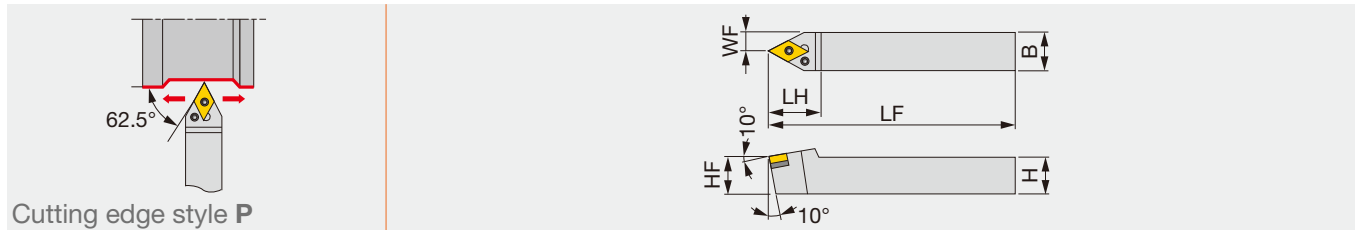

Designation	H	B	LF	LH	HF	WF	RE**	Insert
PDPNN2525	25	25	150	36	25	12.5	0.8	DN**/FNGA1504...
PDPNN2525M15E	25	25	150	36	25	12.5	0.8	DN**/FNGA1506...

**RE: Standard corner radius

SPARE PARTS

Designation	Shim	Clamping screw	Wrench	Spring pin	Lever
PDPNN2525	LSD42	LCS4	P-3	LSP4	LCL4
PDPNN2525M15E	ELSD42	ELCS4	P-3	LSP4S	LCL44

INSERT SELECTION

Application	Precision finishing	Finishing	Medium cutting	Medium to heavy cutting
	Grade	NS9530	GT9530	T9215
Chipbreaker shape	TF	TSF	TM	TH
Cutting conditions	B004			

Application	Finishing	Medium cutting	Medium to heavy cutting
	Grade	T6215	AH6225
Chipbreaker shape	SF	SM	SH
Cutting conditions	B006		

Application	Finishing	Medium cutting	Medium to heavy cutting
	Grade	T515	T515
Chipbreaker shape	All-round	All-round	All-round
Cutting conditions	B008		

Application	Precision finishing	Finishing	Medium cutting
	Grade	DX120	DX140
Chipbreaker shape	DIA	DIA with rake	P
Cutting conditions	B010		

Application	Precision finishing	Finishing	Medium cutting
	Grade	BX470	AH8005
Chipbreaker shape	CBN	HRF	HRM
Cutting conditions	B012		

Application	Precision finishing	Finishing
	Grade	BXA10
Chipbreaker shape	CBN	CBN
Cutting conditions	B014	

Reference pages: ADPNN, PDPNN: Inserts → B066 -, CBN → B172 -, B176, PCD → B211

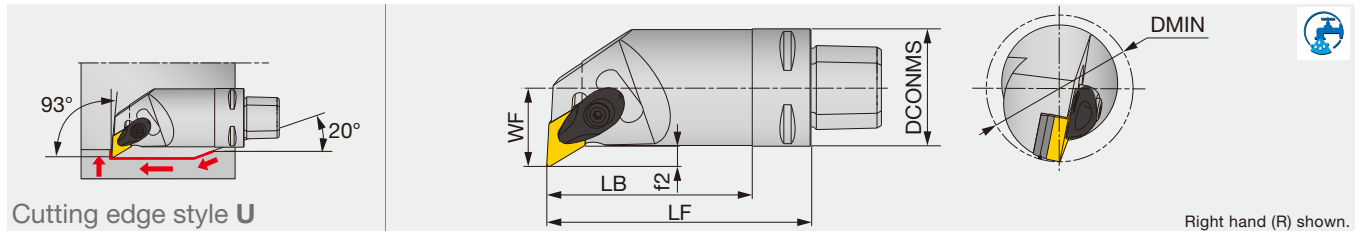

Designation	DMIN	DCONMS	LF	LB	WF	f2	RE	Insert
C4ADUNR20070-15	38	40	70	50	20	5	0.8	DN**/FNGA1504...
C4ADUNR27090-15	50	40	90	-	27	7	0.8	DN**/FNGA1504...

Applicable for 7 MPa coolant

SPARE PARTS

Designation	Clamp	Clamp screw	Shim	Shim screw	Spring	Spring pin	Wrench
C*ADUNR/L...	ACP4S	ACS-5W	ASD432	CSTB-3.5	BP-7	SP-2.5	T-15F

Option: ASD423 (Shim for DN**1506**)

INSERT SELECTION

Application	Precision finishing	Finishing	Medium cutting	Medium to heavy cutting
	Grade	NS9530	GT9530	T9215
Chipbreaker shape	TF	TSF	TM	TH
Cutting conditions	B004			

Application	Finishing	Medium cutting	Medium to heavy cutting
	Grade	T6215	AH6225
Chipbreaker shape	SF	SM	SH
Cutting conditions	B006		

Application	Finishing	Medium cutting	Medium to heavy cutting
	Grade	T515	T515
Chipbreaker shape	All-round	All-round	All-round
Cutting conditions	B008		

Application	Precision finishing	Finishing	Medium cutting
	Grade	DX120	DX140
Chipbreaker shape	DIA	DIA with rake	P
Cutting conditions	B010		

Application	Precision finishing	Finishing	Medium cutting
	Grade	BX470	AH8005
Chipbreaker shape	CBN	HRF	HRM
Cutting conditions	B012		

Application	Precision finishing	Finishing
	Grade	BXA10
Chipbreaker shape	CBN	CBN
Cutting conditions	B014	

Reference pages: C-ADUNR/L: Inserts → B066 -, CBN → B172 -, B176, PCD → B211
Parts for coolant hose → C115



Lever-lock toolholder, with 93° approach angle, for negative 60° triangular inserts, with high pressure coolant capability

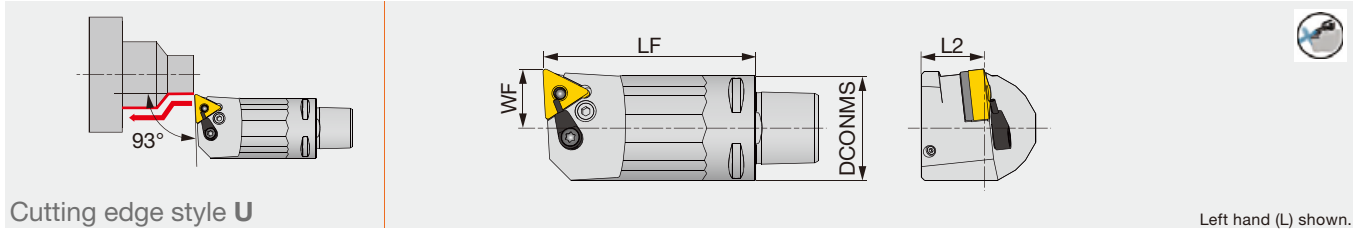

Cutting edge style U

Left hand (L) shown.

Designation	DCONMS	LF	L2	WF	RE	Insert
C3PTUNL18040-16-CHP	32	40	19	18	0.8	TN**1604...
C3PTUNL18065-16-CHP	32	65	19	18	0.8	TN**1604...

Applicable for 14 MPa coolant
Cannot be used for boring

SPARE PARTS

Designation	Coolant unit	Shim	Lever	Clamping screw	Spring pin	Wrench
C3PTUNL...	S-CU-CHP	LST317	LCL3	LCS3	LSP3	P-2.5

INSERT SELECTION

Application	Precision finishing	Finishing	Medium cutting	Medium to heavy cutting
	Grade	NS9530	GT9530	T9215
Chipbreaker shape	TF	TSF	TM	TH
Cutting conditions	B004			

Application	Finishing	Medium cutting
	Grade	T6215
Chipbreaker shape	SF	SM
Cutting conditions	B006	

Application	Finishing	Medium cutting	Medium to heavy cutting
	Grade	T515	T515
Chipbreaker shape	All-round	All-round	All-round
Cutting conditions	B008		

Application	Precision finishing	Finishing	Medium cutting
	Grade	DX120	DX140
Chipbreaker shape	DIA	with rake DIA	P
Cutting conditions	B010		

Application	Precision finishing	Finishing	Medium cutting
	Grade	BX470	AH8005
Chipbreaker shape	CBN	HRF	HRM
Cutting conditions	B012		

Application	Precision finishing	Finishing
	Grade	BXA10
Chipbreaker shape	CBN	CBN
Cutting conditions	B014	

Reference pages: C-PTUNL-CHP: Inserts → **B087** -, CBN → **B182** -, PCD → **B212**
Parts for coolant hose → **C115**

Screw-on toolholder, with 93° approach angle, for positive 55° rhombic inserts, with high pressure coolant capability

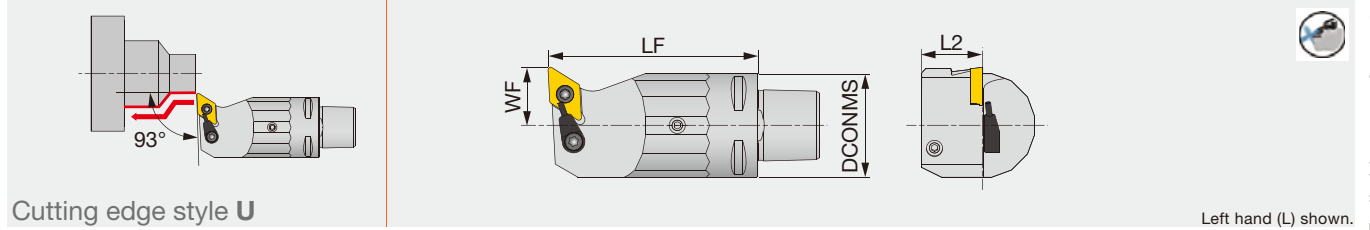

Cutting edge style **U**

Left hand (L) shown.

Designation	DCONMS	LF	L2	WF	RE	Insert
C3SDUCL18040-11-CHP	32	40	19	18	0.8	DC**11T3...
C3SDUCL18065-11-CHP	32	65	19	18	0.8	DC**11T3...

Applicable for 14 MPa coolant
Cannot be used for boring

SPARE PARTS

Designation	Clamping screw	Coolant unit	Wrench
C3SDUCL...	CSTB-4S	S-CU-CHP	T-15F

INSERT SELECTION

Application	Finishing	Finishing to medium cutting	Medium cutting
	Grade	NS9530	T9215
Chipbreaker shape	PSS	PS	PM
Cutting conditions	B016		

Application	Precision finishing	Finishing	Finishing to medium cutting	Medium cutting
	Grade	GH330	AH6225	AH6225
Chipbreaker shape	W**	PSS	PS	PM
Cutting conditions	B018			

Application	Finishing to medium cutting
	Grade
Chipbreaker shape	CM
Cutting conditions	B020

Application	Precision finishing	Finishing	Medium cutting
	Grade	DX120	DX140
Chipbreaker shape	DIA	with rake DIA	AL
Cutting conditions	B022		

Application	Finishing	Finishing to medium cutting
	Grade	AH8015
Chipbreaker shape	PSS	PS
Cutting conditions	B024	

Application	Precision finishing	Finishing
	Grade	BXA10
Chipbreaker shape	CBN	CBN
Cutting conditions	B026	

Reference pages: C-SDUCL-CHP: Inserts → **B121** -, CBN → **B194**, PCD → **B214**
Parts for coolant hose → **C115**



Screw-on toolholder, with 93° approach angle, for positive 35° rhombic inserts, with high pressure coolant capability

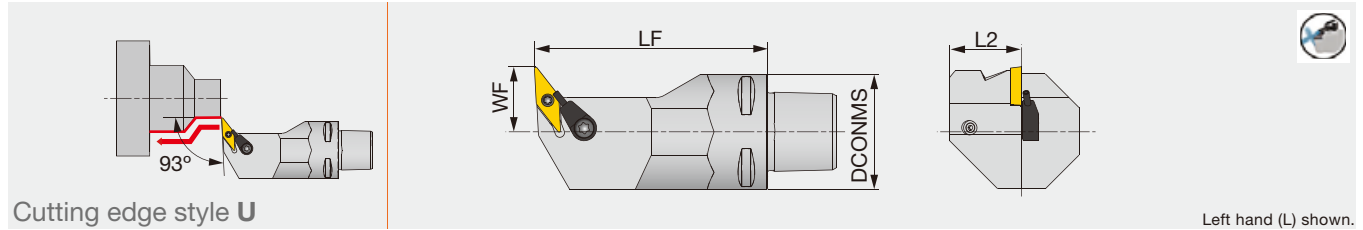

Left hand (L) shown.

Designation	DCONMS	LF	L2	WF	RE	Insert
C3SVUCL18065-11-CHP	32	65	20	18	0.4	VC**1103...

Applicable for 14 MPa coolant
Cannot be used for boring

SPARE PARTS

Designation	Clamping screw	Coolant unit	Wrench
C3SVUCL18065-11-CHP	CSTB-2.5	S-CU-CHP	T-8F

INSERT SELECTION

Application	Finishing	Finishing to medium cutting
	Grade	NS9530
Chipbreaker shape	PSS	PS
Cutting conditions	B016	

Application	Finishing	Finishing to medium cutting
	Grade	AH6225
Chipbreaker shape	PSS	PS
Cutting conditions	B018	

Application	Finishing to medium cutting
	Grade
Chipbreaker shape	CM
Cutting conditions	B020

Application	Precision finishing	Finishing	Medium cutting
	Grade	DX120	DX140
Chipbreaker shape	DIA	with rake DIA	AL
Cutting conditions	B022		

Application	Finishing	Finishing to medium cutting
	Grade	AH8015
Chipbreaker shape	PSS	PS
Cutting conditions	B024	

Application	Precision finishing	Finishing
	Grade	BXA10
Chipbreaker shape	CBN	CBN
Cutting conditions	B026	

Reference pages: C-SVUCL-CHP: Inserts → **B152**

Parts for coolant hose → **C115**

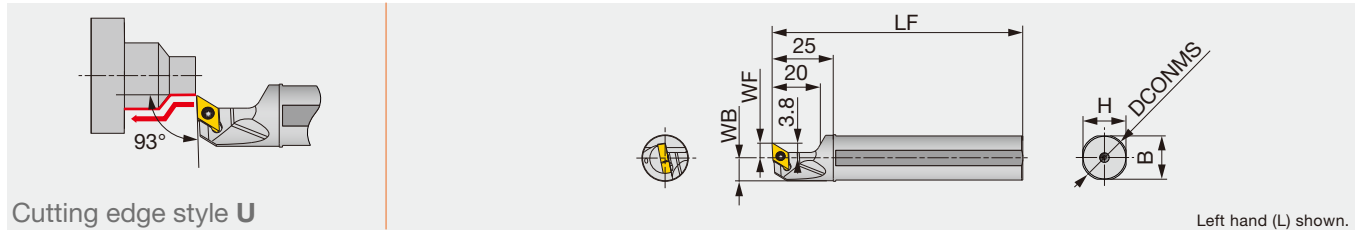

Designation	DCONMS	WF	LF	H	B	WB	RE**	Insert	Torque*
JS14H-SDUXL07	14	6	100	13	13	6.75	0.2	DXGU0703**L...	0.9
JS159F-SDUXL07	15.875	6	85	15	15	7.687	0.2	DXGU0703**L...	0.9
JS16F-SDUXL07	16	6	85	15	15	7.75	0.2	DXGU0703**L...	0.9
JS19G-SDUXL07	19.05	6	90	18	18	9.275	0.2	DXGU0703**L...	0.9
JS19X-SDUXL07	19.05	6	120	18	18	9.275	0.2	DXGU0703**L...	0.9
JS20G-SDUXL07	20	6	90	19	19	9.75	0.2	DXGU0703**L...	0.9
JS20X-SDUXL07	20	6	120	19	19	9.75	0.2	DXGU0703**L...	0.9
JS22X-SDUXL07	22	10	120	21	21	10.75	0.2	DXGU0703**L...	0.9
JS25H-SDUXL07	25	10	100	24	24	12.25	0.2	DXGU0703**L...	0.9
JS254X-SDUXL07	25.4	10	120	24	24	12.45	0.2	DXGU0703**L...	0.9

*Torque: Recommended clamping torque (N·m) **RE: Standard corner radius
Note: Use left-hand toolholders (L) with left-hand inserts (L).

SPARE PARTS

Designation	Clamping screw	Wrench
JS**-SDUXL07	SR34-514	T-7F

INSERT SELECTION

Swiss lathes

Application	Finishing		Medium cutting	
	Grade	SH725	Grade	AH725
Chipbreaker shape	JSS	JTS	JSS	JTS
Cutting conditions	C118			

Small CNC lathes

Application	Finishing		Medium cutting	
	Grade	AH725	Grade	AH8015
Chipbreaker shape	SS	TS	SS	TS
Cutting conditions	C118			

Reference pages: JS-SDUXL: Inserts → **B126** -
Standard cutting conditions → **C118**

Screw-on round-shank toolholder with 93° approach angle, for VXGU inserts

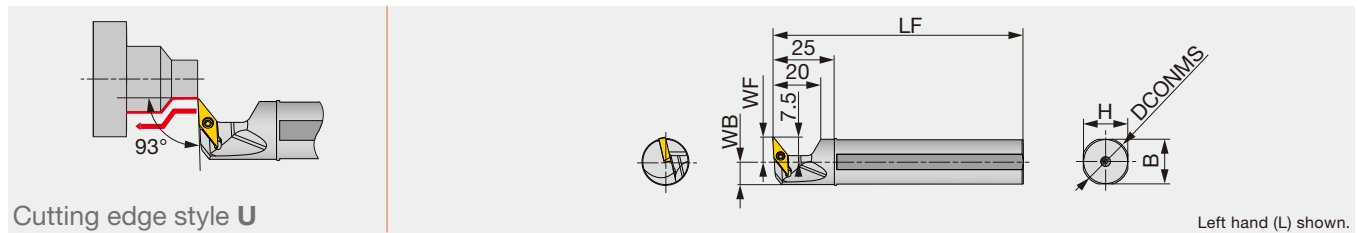

Designation	DCONMS	WF	LF	H	B	WB	RE**	Insert	Torque*
JS159F-SVUXL09	15.875	10	85	15	15	7.7	0.2	VXGU09T2**L...	0.9
JS16F-SVUXL09	16	10	85	15	15	7.7	0.2	VXGU09T2**L...	0.9
JS19G-SVUXL09	19.05	10	90	18	18	9.2	0.2	VXGU09T2**L...	0.9
JS19X-SVUXL09	19.05	10	120	18	18	9.2	0.2	VXGU09T2**L...	0.9
JS20G-SVUXL09	20	10	90	19	19	9.7	0.2	VXGU09T2**L...	0.9
JS20X-SVUXL09	20	10	120	19	19	9.7	0.2	VXGU09T2**L...	0.9
JS22X-SVUXL09	22	10	120	21	21	10.7	0.2	VXGU09T2**L...	0.9
JS25H-SVUXL09	25	10	100	24	24	12.2	0.2	VXGU09T2**L...	0.9
JS254X-SVUXL09	25.4	10	120	24	24	12.4	0.2	VXGU09T2**L...	0.9

*Torque: Recommended clamping torque (N·m) **RE: Standard corner radius
Note: Use left-hand toolholders (L) with left-hand inserts (L).

SPARE PARTS

Designation	Clamping screw	Wrench
JS**-SVUXL09	SR34-508	T-7F

INSERT SELECTION

Application	Finishing	Application	Finishing
	Grade		SH725
Chipbreaker shape	JRP	Chipbreaker shape	JRP
Cutting conditions	C118	Cutting conditions	C118

Reference pages: JS-SVUXL: Inserts → **B155**
Standard cutting conditions → **C118**



PARTS FOR COOLANT HOSE

Connecting hose

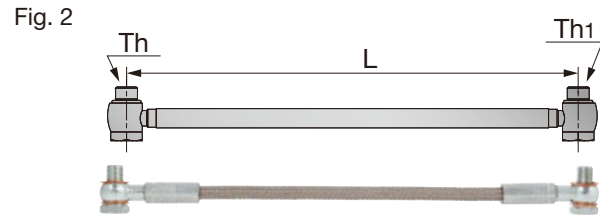
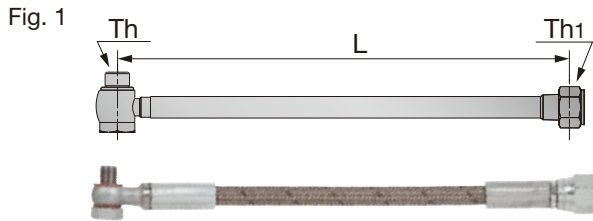

Designation	L	Th	Th1	Max. pressure (Mpa)	Fig.
CHP-HOSE-G1/8-7/16-200BS	200	G1/8"-28 BSPP	7/16"-20 UNF	26	1
CHP-HOSE-G1/8-7/16-250BS	250	G1/8"-28 BSPP	7/16"-20 UNF	26	1
CHP-HOSE-5/16-7/16-200BS	200	5/16"-24UNF	7/16"-20 UNF	20	1
CHP-HOSE-5/16-G1/8-200BS	200	5/16"-24UNF	G1/8"-28 BSPP	20	1
CHP-HOSE-G1/8-G1/8-200BB	200	G1/8"-28 BSPP	G1/8"-28 BSPP	26	2
CHP-HOSE-G1/8-G1/8-250BB	250	G1/8"-28 BSPP	G1/8"-28 BSPP	26	2

Connector

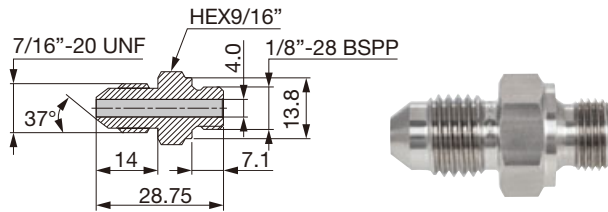

Designation
CHP-NIPPLE-G1/8-7/16UNF

Seal washer

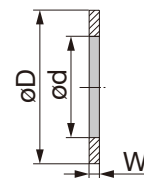

Designation	øD	ød	W
CHP-COPPER-SEAL1/8	15	10	1
CHP-COPPER-SEAL5/16	11.9	8.15	1.35
CHP-COPPER-SEAL5/16-2.5	9.4	8	2.5

Connector for small lathe with seal washer

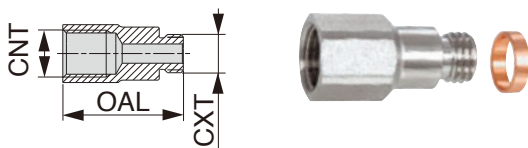

Designation	CNT	CXT	OAL
CHP-CONNECTOR5/16-G1/8	G1/8"-28 BSPP	5/16"-24 UNF	25
CHP-CONNECTOR-G1/8-R1/8	G1/8"-28 BSPP	R1/8"-28 BSPT	25

Connector elbow

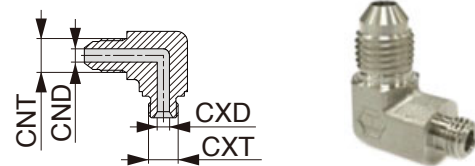

Designation	CNT	CND	CXT	CXD
CHP-ELBOW-90-G1/8-7/16UNF	7/16"-20 UNF	4.4	1/8"-28 BSPP	4
CHP-ELBOW-90-5/16-7/16UNF	7/16"-20 UNF	4.4	5/16"-24 UNF	4

Technical Guide

STANDARD CUTTING CONDITIONS

ADD^{ULTI}TURN

Double-sided 6-corner insert

ISO	Operation	Chipbreaker	Grade	Depth of cut: a_p (mm)		Feed: f (mm/rev)		Cutting speed V_c (m/min)
				Front turning	Back turning	Front turning	Back turning	
P	Finishing	TSF	T9215	0.2 - 1.5	0.2 - 1.5	0.08 - 0.4	0.2 - 1.2	150 - 400
		TSF	T9225	0.2 - 1.5	0.2 - 1.5	0.08 - 0.4	0.2 - 1.2	80 - 300
	Medium to heavy cutting	TM	T9215	0.5 - 2.5	0.5 - 2.5	0.2 - 0.6	0.4 - 1.2	150 - 400
		TM	T9225	0.5 - 2.5	0.5 - 2.5	0.2 - 0.6	0.4 - 1.2	80 - 300
M	Finishing	TSF	T9215	0.2 - 1.5	0.2 - 1.5	0.08 - 0.4	0.2 - 1.2	100 - 250
		TSF	AH8015	0.2 - 1.5	0.2 - 1.5	0.08 - 0.4	0.2 - 1.2	90 - 190
	Medium to heavy cutting	TM	T9215	0.5 - 2.5	0.5 - 2.5	0.2 - 0.6	0.4 - 1.2	100 - 250
		TM	AH8015	0.5 - 2.5	0.5 - 2.5	0.2 - 0.6	0.4 - 1.2	90 - 190
K	Finishing	TSF	T9215	0.2 - 1.5	0.2 - 1.5	0.08 - 0.4	0.2 - 1.2	140 - 500
	Medium to heavy cutting	TM	T9215	0.5 - 2.5	0.5 - 2.5	0.2 - 0.6	0.4 - 1.2	140 - 500
S	Finishing	TSF	AH8015	0.2 - 1.5	0.2 - 1.5	0.08 - 0.4	0.2 - 1.2	20 - 80
	Medium to heavy cutting	TM	AH8015	0.5 - 2.5	0.5 - 2.5	0.2 - 0.6	0.4 - 1.2	20 - 80

Single-sided 3-corner insert

ISO	Operation	Chipbreaker	Grade	Depth of cut: a_p (mm)		Feed: f (mm/rev)		Cutting speed V_c (m/min)
				Front turning	Back turning	Front turning	Back turning	
P	Medium to heavy cutting	TM	T9215	0.5 - 4	0.5 - 2	0.2 - 0.6	0.4 - 2	150 - 400
M	Medium to heavy cutting	TM	T9215	0.5 - 4	0.5 - 2	0.2 - 0.6	0.4 - 2	100 - 250
K	Medium to heavy cutting	TM	T9215	0.5 - 4	0.5 - 2	0.2 - 0.6	0.4 - 2	140 - 500

ADD^{AXIS}TURN

ISO	Operation	Chipbreaker	Grade	Cutting speed V_c (m/min)
P	Finishing	ZF	T9215	150 - 400
	Medium to heavy cutting	TM	T9215	150 - 400
M	Finishing	ZF	T9215	100 - 250
	Medium to heavy cutting	TM	T9215	100 - 250
K	Finishing	ZF	T9215	140 - 500
	Medium to heavy cutting	TM	T9215	140 - 500

Reference pages: ATXOR/L → **C065**, STXCR/L-CHP-MC → **C066**,
C6STECN-Y-CHP → **C069**, C6SDNCN-Y-CHP → **C070**

STANDARD CUTTING CONDITIONS

TURN^{TEN}FEED

For HD holder
(High Depth of Cut)

ISO	Insert	Depth of cut ap (mm)	Feed f (mm/rev)	Cutting speed: Vc (m/min)	
				T9215	T9225
P	POMG110612-MNW	0.8 - 5.5	0.4 - 1.2	150 - 400	120 - 300
	POMG130612-MNW	1 - 7	0.4 - 1.3	150 - 400	120 - 300

ISO	Insert	Depth of cut ap (mm)	Feed f (mm/rev)	Cutting speed: Vc (m/min)
				AH8015
M	POMG110612-MNW	0.8 - 5.5	0.4 - 1.2	50 - 150
	POMG130612-MNW	1 - 7	0.4 - 1.3	50 - 150
S	POMG110612-MNW	0.8 - 5.5	0.4 - 1.2	20 - 80
	POMG130612-MNW	1 - 7	0.4 - 1.3	20 - 80

For HF holder
(High Feed)

ISO	Insert	Depth of cut ap (mm)	Feed f (mm/rev)	Cutting speed: Vc (m/min)	
				T9215	T9225
P	POMG110612-MNW	1 - 2.5	0.5 - 1.5	150 - 400	120 - 300
	POMG130612-MNW	1 - 3	0.5 - 2	150 - 400	120 - 300

ISO	Insert	Depth of cut ap (mm)	Feed f (mm/rev)	Cutting speed: Vc (m/min)
				AH8015
M	POMG110612-MNW	1 - 2.5	0.5 - 1.5	50 - 150
	POMG130612-MNW	1 - 3	0.5 - 2	50 - 150
S	POMG110612-MNW	1 - 2.5	0.5 - 1.5	20 - 80
	POMG130612-MNW	1 - 3	0.5 - 2	20 - 80

Technical Guide

STANDARD CUTTING CONDITIONS

MINIFORCE TURN

Applications	ISO	Workpiece material	Priority	Chipbreaker	Grade	Cutting speed Vc (m/min)	Depth of cut ap (mm)	Feed f (mm/rev)
Swiss lathes	P	Low carbon steel SS400, etc. E275A, etc. Carbon steel S45C, etc. C45, etc. Low alloy steel SCM415, etc. 18CrMo4, etc. Alloy steel SCM440, etc. 42CrMo4, etc.	First choice	JS	SH725	50 - 180	0.1 - 3	0.03 - 0.1
			Sharpness	JSS	SH725	50 - 180	0.1 - 1.5	0.03 - 0.1
	M	Stainless steel (Austenitic) SUS304, etc. X5CrNi18-9, etc. Stainless steel (Martensitic and ferritic) SUS430, etc. X6Cr17, etc. Stainless steel (Precipitation hardened) SUS630, etc. X5CrNiCuNb16-4, etc.	First choice	JS	SH725	50 - 180	0.1 - 1.25	0.03 - 0.1
			Sharpness	JSS	SH725	50 - 180	0.1 - 1.5	0.03 - 0.1
Small CNC lathes	P	Low carbon steel SS400, etc. E275A, etc. Carbon steel S45C, etc. C45, etc. Low alloy steel SCM415, etc. 18CrMo4, etc. Alloy steel SCM440, etc. 42CrMo4, etc.	First choice	SS	AH725	50 - 180	0.15 - 1.5	0.05 - 0.2
				TS	AH725	50 - 180	0.3 - 2	0.08 - 0.3
			Surface quality	SS	NS9530	50 - 200	0.15 - 1.5	0.05 - 0.2
				TS	NS9530	50 - 200	0.3 - 2	0.08 - 0.3
	Wear resistance	SS	GT9530	50 - 250	0.15 - 1.5	0.05 - 0.2		
		TS	GT9530	50 - 250	0.3 - 2	0.08 - 0.3		
M	Stainless steel (Austenitic) SUS304, etc. X5CrNi18-9, etc. Stainless steel (Martensitic and ferritic) SUS430, etc. X6Cr17, etc. Stainless steel (Precipitation hardened) SUS630, etc. X5CrNiCuNb16-4, etc.	First choice	SS	AH725	50 - 150	0.15 - 1.5	0.05 - 0.2	
			Fracture resistance	TS	AH725	50 - 150	0.3 - 2	0.08 - 0.3

DIMPLEFX

ISO	Workpiece material	Grade	Cutting speed Vc (m/min)	Depth of cut ap (mm)	Feed f (mm/rev)
K	Grey cast irons	FX105	700 (300 - 1000)	1 (0.05 - 3)	0.3 (0.05 - 0.6)
	Ductile cast irons	FX105	200 (100 - 300)	1 (0.05 - 3)	0.2 (0.05 - 0.4)

Reference pages: CCLNR/L-RD → **C022**, JSWLXR/L, JSWL2XR/L → **C029**,
 CDJNR/L-RD → **C040**, JSDJXR/L, JSDJ2XR/L → **C045**
 JSVJXR/L, JSVJ2XR/L → **C047**, CVVNN-RD → **C051**, CDNNN-RD → **C072**,
 CSSNR/L → **C082**, CHSNR/L → **C083**, JS-SDUXL, JS-SVUXL → **C114**



STANDARD CUTTING CONDITIONS

TURNTEC

LNMX1204

*Values in red are for facing.

ISO	Workpiece material	Chip breaker	Grade	Cutting speed Vc (m/min)	Depth of cut: ap (mm)		Feed: f (mm/rev)	
					RE : 0.8	RE : 1.2	RE : 0.8	RE : 1.2
P	Steel S45C, SCM415, etc. C45, 18CrMo4, etc.	TDR	T9115	120 - 250	0.5 - 5 0.5 - 2.2	0.8 - 5 0.8 - 2.2	0.15 - 0.6	0.25 - 0.8
		TDR	T9125	80 - 180	0.5 - 5 0.5 - 2.2	0.8 - 5 0.8 - 2.2	0.15 - 0.6	0.25 - 0.8
M	Stainless steel SUS304, SUS316, etc. X5CrNi18-9, X5CrNiMo17-12-2, etc.	TDR	T9115	100 - 180	0.5 - 5 0.5 - 2.2	0.8 - 5 0.8 - 2.2	0.15 - 0.6	0.25 - 0.8
		TDR	T9125	80 - 180	0.5 - 5 0.5 - 2.2	0.8 - 5 0.8 - 2.2	0.15 - 0.6	0.25 - 0.8

LNMX1606

ISO	Workpiece material	Chip breaker	Grade	Cutting speed Vc (m/min)	Depth of cut: ap (mm)			Feed: f (mm/rev)		
					RE : 0.8	RE : 1.2	RE : 1.6	RE : 0.8	RE : 1.2	RE : 1.6
P	Steel S45C, SCM415, etc. C45, 18CrMo4, etc.	TDR	T9115	120 - 250	0.5 - 5 0.5 - 3.2	0.8 - 6 0.8 - 3.2	1 - 8 1 - 3.2	0.15 - 0.6	0.25 - 0.8	0.3 - 1
		TDR	T9125	80 - 180	0.5 - 5 0.5 - 3.2	0.8 - 6 0.8 - 3.2	1 - 8 1 - 3.2	0.15 - 0.6	0.25 - 0.8	0.3 - 1
		TWR	T9115	120 - 250	1 - 8 1 - 3.2	0.8 - 6 0.8 - 3.2	-	0.15 - 0.6	0.25 - 0.8	-
		TWR	T9125	80 - 180	1 - 8 1 - 3.2	0.8 - 6 0.8 - 3.2	-	0.15 - 0.6	0.25 - 0.8	-
M	Stainless steel SUS304, SUS316, etc. X5CrNi18-9, X5CrNiMo17-12-2, etc.	TDR	T9115	100 - 180	0.5 - 5 0.5 - 3.2	0.8 - 6 0.8 - 3.2	1 - 8 1 - 3.2	0.15 - 0.6	0.25 - 0.8	0.3 - 1
		TDR	T9125	80 - 180	0.5 - 5 0.5 - 3.2	0.8 - 6 0.8 - 3.2	1 - 8 1 - 3.2	0.15 - 0.6	0.25 - 0.8	0.3 - 1
		MDR	T9115	100 - 150	1.5 - 6 0.5 - 3.2	1.5 - 7 0.8 - 3.2	-	0.1 - 0.5	0.15 - 0.7	-
		MDR	AH725	50 - 150	1.5 - 6 0.5 - 3.2	1.5 - 7 0.8 - 3.2	-	0.1 - 0.5	0.15 - 0.7	-
		TWR	T9115	100 - 180	0.5 - 5 0.5 - 3.2	0.8 - 6 0.8 - 3.2	-	0.15 - 0.6	0.25 - 0.8	-
		TWR	T9125	80 - 180	0.5 - 5 0.5 - 3.2	0.8 - 6 0.8 - 3.2	-	0.15 - 0.6	0.25 - 0.8	-

LNMX2410

ISO	Workpiece material	Chip breaker	Grade	Cutting speed Vc (m/min)	Depth of cut: ap (mm)		Feed: f (mm/rev)	
					RE : 1.6	RE : 2.4	RE : 1.6	RE : 2.4
P	Steel S45C, SCM415, etc. C45, 18CrMo4, etc.	TDR	T9115	120 - 250	4 - 15 1 - 4.5	5 - 15 1 - 4.5	0.3 - 1	0.3 - 1.1
		TDR	T9125	80 - 150	4 - 15 1 - 4.5	5 - 15 1 - 4.5	0.3 - 1	0.3 - 1.1
M	Stainless steel SUS304, SUS316, etc. X5CrNi18-9, X5CrNiMo17-12-2, etc.	TDR	T9115	100 - 180	4 - 15 1 - 4.5	5 - 15 1 - 4.5	0.3 - 1	0.3 - 1.1
		TDR	T9125	80 - 150	4 - 15 1 - 4.5	5 - 15 1 - 4.5	0.3 - 1	0.3 - 1.1

TURNFEED

ISO	Workpiece material	Grade	Chipbreaker	Cutting speed Vc (m/min)	Depth of cut ap (mm)	Feed f (mm/rev)
P	Mild and low carbon steels SS400, SM490, etc. E275A, C15E4, etc. < 180 HB	T9225	ML	100 - 300	0.5 - 2.5	0.5 - 2.5
	Carbon and alloy steels S55C, SCM440, etc. C55, 42CrMo4, etc. < 300HB	T9215	ML	120 - 350	0.5 - 2.5	0.5 - 2.5
M	Stainless steels SUS304, SUS316, etc. X5CrNi18-9, X5CrNiMo17-12-3, etc. < 250 HB	T9225	ML	100 - 300	0.5 - 2.5	0.5 - 2.5
K	Grey and ductile cast irons FC250, FCD400, etc. 250, 400-15S, etc.	AH120	ML	100 - 250	0.5 - 2.5	0.5 - 2.5

Note: When the side cutting edge is used for facing, the maximum feed is limited to within 1 mm/rev.

Reference pages: TLANR/L → C054, XWXPR/L → C068,
TLFNR/L → C090, TLBNR/L → C103

Technical Guide

STANDARD CUTTING CONDITIONS

Y-PRO SERIES

For negative insert

ISO	Operation	Chipbreaker	Grades	Depth of cut ap (mm)	Feed f (mm/rev)	Cutting speed: Vc (m/min)		
						Low carbon steels, alloy steels	Medium carbon steels, alloy steels	High carbon steels, alloy steels
P	Finishing	ZF	GT9530	0.2 - 1.5	0.03 - 0.2	150 - 300	150 - 300	150 - 300
			NS9530	0.2 - 1.5	0.03 - 0.2	150 - 300	150 - 300	150 - 300
			T9225	0.2 - 1.5	0.03 - 0.2	120 - 300	120 - 300	100 - 250
			T9235	0.2 - 1.5	0.03 - 0.2	50 - 200	50 - 200	50 - 150
	Finishing to medium	ZM	GT9530	0.7 - 2	0.15 - 0.4	150 - 300	150 - 300	150 - 300
			NS9530	0.7 - 2	0.15 - 0.4	150 - 300	150 - 300	150 - 300
			T9225	0.7 - 2	0.15 - 0.4	120 - 300	120 - 300	100 - 250
			T9235	0.7 - 2	0.15 - 0.4	50 - 200	50 - 200	50 - 150
Stainless steels								
M	Finishing	ZF	AH8015	0.2 - 1.5	0.03 - 0.2	50 - 150	50 - 150	50 - 150
	Finishing to medium	ZM	AH8015	0.7 - 2	0.15 - 0.4	50 - 150	50 - 150	50 - 150
Casrt iron								
K	Finishing	ZF	T9225	0.2 - 1.5	0.03 - 0.2	140 - 500	140 - 500	140 - 500
	Finishing to medium	ZM	T9225	0.7 - 2	0.15 - 0.4	140 - 500	140 - 500	140 - 500
Heat-resistant alloys								
S	Finishing	ZF	AH8015	0.2 - 1.5	0.03 - 0.2	20 - 80	20 - 80	20 - 80
	Finishing to medium	ZM	AH8015	0.7 - 2	0.15 - 0.4	20 - 80	20 - 80	20 - 80

For positive insert

ISO	Operation	Chipbreaker	Grades	Depth of cut ap (mm)	Feed f (mm/rev)	Cutting speed: Vc (m/min)		
						Low carbon steels, alloy steels	Medium carbon steels, alloy steels	High carbon steels, alloy steels
P	Finishing to medium	ZF	GT9530	0.2 - 1.5	0.05 - 0.25	150 - 300	150 - 300	150 - 300
			T9225	0.2 - 1.5	0.05 - 0.25	100 - 300	80 - 300	80 - 250
		ZM	GT9530	0.5 - 2	0.05 - 0.3	150 - 300	150 - 300	150 - 300
			T9225	0.5 - 2	0.05 - 0.3	100 - 300	80 - 300	80 - 250
Stainless steels								
M	Finishing to medium	ZF	AH8015	0.2 - 1.5	0.05 - 0.25	50 - 150	50 - 150	50 - 150
		ZM	AH8015	0.5 - 2	0.05 - 0.3	50 - 150	50 - 150	50 - 150
Casrt iron								
K	Finishing to medium	ZF	T9225	0.2 - 1.5	0.05 - 0.25	140 - 500	140 - 500	140 - 500
		ZM	T9225	0.5 - 2	0.05 - 0.3	140 - 500	140 - 500	140 - 500
Heat-resistant alloys								
S	Finishing to medium	ZF	AH8015	0.2 - 1.5	0.05 - 0.25	20 - 80	20 - 80	20 - 80
		ZM	AH8015	0.5 - 2	0.05 - 0.3	20 - 80	20 - 80	20 - 80

FIXTURN

ISO	Workpiece material	Chipbreaker	Grade	Cutting Speed Vc (m/min)	Depth of cut ap (mm)	Feed f (mm/rev)
P	Steels S45C, SCM415, etc. C45, 18CrMo4, etc.	6RS	T9215	120 - 350	0.5 - 2	0.5 - 1
		6RS	T9225	100 - 300	0.5 - 2	0.5 - 1
		6RS	NS9530	150 - 250	0.5 - 2	0.5 - 1
		6RM	T9215	120 - 350	1 - 3	0.5 - 1
		6RM	T9225	100 - 300	1 - 3	0.5 - 1
		6RM	NS9530	150 - 250	1 - 3	0.5 - 1

Reference pages: SYJBR/L → C049, SYIBN → C053, SRGCR/L-6F → C064, SRDCR/L-6F → C078
SYQBR/L, SVHCR/L → C098

Internal Toolholder



Internal Toolholder - Content structure

- Indexable toolholders are listed by cutting edge shape.
- Toolholders in the catalog are our standard items.

How to use the page

- Method 1** Select the cutting edge shape described at the left end of each page, jump to the page on the left index, and choose a designation you need (4) in the dimension table (3). Applicable inserts are shown in (6) and (8).
- Method 2** Select the cutting edge on D003 and check the details on the product page.
- Method 3** Select the series name of a toolholder on D003 and check the details on each page.
- Method 4** Select an item from Quick Guide on D004 - D009.

2 BOREMEISTER
S-SVLCR/L-H
Screw-on clamp exchangeable boring head, for positive 35° rhombic inserts

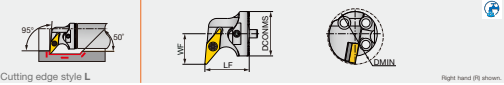

Cutting edge style L

1 **1**

Designation	DMIN	DCONMS	WF	LF	Shank	Insert
S30-SVLCR/L-ET-H	40	32	22	32	D32	VC**1604...
S40-SVLCR/L-ET-H	50	42	32	42	D50, D50, D50	VC**1604...

Note: Use (6) toolholders (B/LCP*) with left-hand inserts (L) and left-hand (R) (B/LCL*) with right-hand inserts (R).

4 **3** **6**

SPARE PARTS

Designation	Clamping screw	Wrench	Clamp	Shank force
S30-SVLCR/L-ET-H	SR18-20P	T-155	TVC3-3P	SRTIC-3P
S40-SVLCR/L-ET-H	SR18-20P	T-155	TVC3-3P	SRTIC-3P

INSERT SELECTION

Application	Finishing to medium cutting	Finishing to medium cutting	Application	Finishing to medium cutting	Finishing to medium cutting
Grade: H9300 Breaker Shape: PS5	Grade: T9215 Breaker Shape: PS5	Grade: T9215 Breaker Shape: PS5	Application: Chipbreaker Grade: PS5	Application: Chipbreaker Grade: PS5	Application: Chipbreaker Grade: PS5
Grade: CM Breaker Shape: TS	Grade: DA Breaker Shape: TS	Grade: DA Breaker Shape: TS	Application: Precision finishing Grade: DA	Application: Precision finishing Grade: DA	Application: Precision finishing Grade: DA
Grade: AH005 Breaker Shape: PS	Grade: AH015 Breaker Shape: PS	Grade: AH015 Breaker Shape: PS	Application: Precision finishing Grade: BXA10	Application: Precision finishing Grade: BXA20	Application: Precision finishing Grade: BXA30

Reference pages: S-SVLCR/L-H: Insert → B152, CBN → B209, PCD → B220
Shank → D090 - D092

D020 tungaloy.com

MINIFURN
A/E-SCLXR/L
Screw-on boring bar, for CXMU inserts



Cutting edge style L

5



Designation	Material	DMIN	DCONMS	WF	LF	LH	H	GAMP	GAMP	RE**	Insert	Torque*
A10K-SCLXR/L06-D120	Steel	12	10	6	125	20	9	-10°	-14.5°	0.4	CXMU0603**L/R...	0.9
A12M-SCLXR/L06-D140	Steel	14	12	7	150	24	11	-10°	-12.5°	0.4	CXMU0603**L/R...	0.9
A16Q-SCLXR/L06-D180	Steel	18	16	9	180	32	15	-10°	-9.5°	0.4	CXMU0603**L/R...	0.9
A20R-SCLXR/L06-E220	Steel	22	20	11	200	36	18	-10°	-8°	0.4	CXMU0603**L/R...	0.9
E10M-SCLXR/L06-D120	Carbide	12	10	6	150	25	9	-10°	-14.5°	0.4	CXMU0603**L/R...	0.9
E12Q-SCLXR/L06-D140	Carbide	14	12	7	180	27	11	-10°	-12.5°	0.4	CXMU0603**L/R...	0.9
E16R-SCLXR/L06-D180	Carbide	18	16	9	200	32	15	-10°	-9.5°	0.4	CXMU0603**L/R...	0.9
E20S-SCLXR/L06-E220	Carbide	22	20	11	250	36	18	-10°	-8°	0.4	CXMU0603**L/R...	0.9

* Torque: Recommended clamping torque (N·m) ** RE: Standard corner radius
Use right-hand toolholders (R) with left-hand inserts (L) and left-hand toolholders (L) with right-hand inserts (R).

7 **SPARE PARTS**

Designation	Clamping screw	Wrench
A/E-SCLXR/L...	SR34-S14	T-7F

- Use the right hand toolholder (R) for the left hand insert (L)
- Use the left hand toolholder (L) for the right hand insert (R)

Right hand toolholder with left hand insert shown Left hand toolholder with right hand insert shown

8 **INSERT SELECTION**

Application	Finishing to medium cutting	Finishing to medium cutting	Application	Finishing to medium cutting	Finishing to medium cutting
Grade: T9215 Breaker Shape: TS	Grade: T9215 Breaker Shape: TS	Grade: T9215 Breaker Shape: TS	Application: Chipbreaker Grade: TS	Application: Chipbreaker Grade: TS	Application: Chipbreaker Grade: TS
Grade: CM Breaker Shape: TS	Grade: DA Breaker Shape: TS	Grade: DA Breaker Shape: TS	Application: Precision finishing Grade: DA	Application: Precision finishing Grade: DA	Application: Precision finishing Grade: DA
Grade: AH005 Breaker Shape: PS	Grade: AH015 Breaker Shape: PS	Grade: AH015 Breaker Shape: PS	Application: Precision finishing Grade: BXA10	Application: Precision finishing Grade: BXA20	Application: Precision finishing Grade: BXA30

Reference pages: A/E-SCLXR/L: Insert → B120
Standard cutting conditions → D096

Tungaloy D021

- 1** : Cutting edge shape
- 2** : Series name of indexable boring bars
- 3** : Dimension table
- 4** : Toolholder designation
e.g. To select right-handed steel shank with minimum machining diameter $\phi 13$









→ **A10K-SDXXR07-D130**

- 5** : Dimension drawing (conforming to ISO13399)
- 6** : Applicable insert
- 7** : Spare parts
- 8** : Insert selection
- 9** : Reference pages

When ordering

- Please specify the designation and quantity.
e.g. **A12M-SDZXRL07-D140 ... 1** (one boring bar per package)
- * Inserts are not included. Please order those separately.

Main products

L		D014
X		D034
J		D038
A		D040
K		D041
F		D045
U		D052
Q		D076
Z		D084
OTHERS		D090



BOREMEISTER

Boring head suitable for L/D=10



Shank \varnothing 16 - 60 mm

D010



MINIFORCE

Economical double-sided inserts with excellent sharpness



Shank \varnothing 10 - 20 mm

D013



ISOETURN

Small-sized "Eco" insert series for maximized profits



Shank \varnothing 16 - 32 mm

D025 -, D031 -
D049 -, D067
D069 -, D074



STREAMJETBAR

Highly rigid toolholders providing good chip evacuation



Shank \varnothing 4 - 50 mm

D011



Y-PRO SERIES

Inserts with 25° corner angle for profiling



Shank \varnothing 12 - 16 mm

D064, D083



TURNINGA

Highly rigid clamping system with excellent repeatability



Shank \varnothing 25 - 50 mm

D030, D033, D044
D051, D072, D075



TUNGTURN

Toolholders for high pressure coolant supply



D026, D071



TUNGBOREMINI

Multifunctional tool for drilling, external turning and internal turning



Shank \varnothing 8 - 12 mm

D012

Sleeve

D092 -

Internal Toolholder - Quick Guide

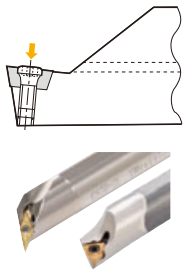
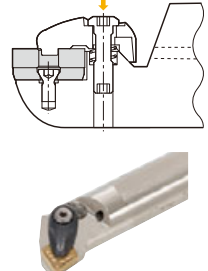
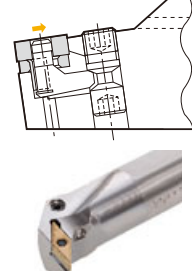
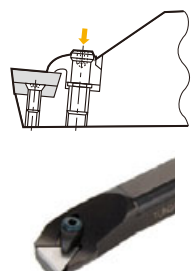
Screw-on	Double clamping	Lever-lock	Clamp-on
 <p>STREAMJETBAR MINIFURN</p>	 <p>TURNINGA</p>	 <p>ISOEFURN</p>	
<ul style="list-style-type: none"> • Simple clamping mechanism. • Smart shape without overhang area. • Minimum bore diameter: $\varnothing 4.5$ mm. • Good cutting action by using positive inserts. • Carbide shanks that have excellent resistance to chatter. • “Tsuppari-Ichiban” shanks (reinforced with carbide plates) are also stocked. 	<ul style="list-style-type: none"> • Increased clamping rigidity contributes to superior cutting edge positioning accuracy & longer tool life. • Enlarged insert holding area of the clamp allows more accurate cutting edge positioning. It delivers high performance even when using VNMG type (35° corner angle) inserts, which tend to destabilize cutting edge positioning. • Simple structure keeps cost low. Easy clamping with only one wrench. 	<ul style="list-style-type: none"> • Negative rake, lever-lock type, round shank boring bars. • The insert is positively held into a two wall pocket, excelling in indexing accuracy. • Minimum bore diameter: $\varnothing 20$ mm. • “Tsuppari-Ichiban” shanks that are reinforced with carbide plates are also stocked. 	<ul style="list-style-type: none"> • Clamp-on type insert locking mechanism assures secure holding & accurate indexing. • For inserts without a hole, it provides stronger cutting edge strength than S-type tools & can withstand heavier cutting conditions. • Minimum bore diameter: $\varnothing 16$ mm

Tool selection according to the ratio of length to tool diameter (L/D) for different shank materials

Steel shank	Carbide reinforced	Carbide shank	BoreMeister
L/D ≤ 3	L/D ≤ 4	L/D ≤ 5	L/D ≤ 10

For custom tooling inquiries, contact Tungaloy

Positive type

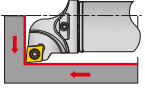
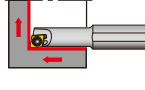
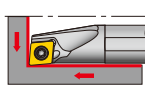
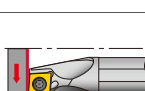
Application	Style	Designation	Insert	Material	Through coolant	ISO Insert	BOREMEISTER	STREAMJETBAR	Min. bore diameter DMIN (mm)						Page	
									0	10	20	30	40	50		
Boring & internal facing		S-SCLCR/L-H	CC...	Steel Carbide	<input type="radio"/>	<input checked="" type="checkbox"/>	<input checked="" type="checkbox"/>	<input type="checkbox"/>	<input type="checkbox"/>	<input type="checkbox"/>	<input type="checkbox"/>	<input type="checkbox"/>	<input type="checkbox"/>	<input type="checkbox"/>	<input type="checkbox"/>	D017
		SEXPR/L	EP...	Steel Carbide	<input type="radio"/>	<input checked="" type="checkbox"/>	<input type="checkbox"/>	<input checked="" type="checkbox"/>	<input type="checkbox"/>	<input type="checkbox"/>	<input type="checkbox"/>	<input type="checkbox"/>	<input type="checkbox"/>	<input type="checkbox"/>	<input type="checkbox"/>	D034 D035
		SCLCR/L	CC...	Steel Carbide Reinforced	<input type="radio"/>	<input checked="" type="checkbox"/>	<input type="checkbox"/>	<input checked="" type="checkbox"/>	<input type="checkbox"/>	<input type="checkbox"/>	<input type="checkbox"/>	<input type="checkbox"/>	<input type="checkbox"/>	<input type="checkbox"/>	<input type="checkbox"/>	D014 - D016
		SCLPR/L	CP...	Steel Carbide Reinforced	<input type="radio"/>	<input checked="" type="checkbox"/>	<input type="checkbox"/>	<input checked="" type="checkbox"/>	<input type="checkbox"/>	<input type="checkbox"/>	<input type="checkbox"/>	<input type="checkbox"/>	<input type="checkbox"/>	<input type="checkbox"/>	<input type="checkbox"/>	D018 D019

Positive type

Application	Style	Designation	Insert	Material	Through coolant	ISO Insert	Min. bore diameter DMIN (mm)						Page
							0	10	20	30	40	50	
Boring & internal profiling		S-SDUCR/L-H	DC...	Steel Carbide	○	✓	✓		ø20		ø50		D057
		S-SVUCR/L-H	VC...	Steel Carbide	○	✓	✓		ø27		ø31		D063
		S-SVLCR/L-H	VC...	Steel Carbide	○	✓	✓			ø40	ø50		D020
		S-DDUNR/L-H	DN...	Steel Carbide	○	✓	✓			ø40	ø50		D073
		S-DVUNR/L-H	VN...	Steel Carbide	○	✓	✓				ø52		D075
		SDUCR/L	DC...	Steel Carbide	○	✓	✓		ø13		ø32		D056
		SDUPR/L	DP...	Steel Carbide	○		✓		ø15		ø22		D058
		SVUCR/L	VC...	Steel Carbide Reinforced	○	✓	✓		ø16		ø32		D061
		SVUBR/L	VB...	Steel Carbide Reinforced	○	✓	✓		ø20		ø32		D059
		SDQCR/L	DC...	Steel Carbide Reinforced	○	✓	✓		ø13		ø30		D076 D077
		SDQPR/L	DP...	Steel Carbide	○		✓		ø15		ø22		D078
		SVQCR/L	VC...	Steel Carbide Reinforced	○	✓	✓		ø13.5		ø21.5		D081
		SVQBR/L	VC...	Steel Carbide Reinforced	○	✓	✓		ø17		ø30.5		D079

Grade
Insert
Ext. Toolholder
Int. Toolholder
Threading
Grooving
Miniature tool
Milling cutter
Endmill
Drilling tool
Tooling System
User's Guide
Index



Internal Toolholder - Quick Guide





Positive type

Application	Style	Designation	Insert	Material	Through coolant	ISO Insert	Min. bore diameter DMIN (mm)						Page
							0	10	20	30	40	50	
Boring & internal profiling		SYUBR/L	YW...	Steel	○	✓	ø20						D064
				Carbide	○		ø20 ø24.5						
Boring		SWUBR/L	WB...	Steel	○	✓	ø6 ø8						D052
				Carbide	○		ø6 ø8						
Boring		STUPR/L	TP...	Steel	○	✓	ø8 ø34						D053 - D055
				Carbide	○		ø8 ø27						
Blind hole boring		STFPR/L	TP...	Steel	○	✓	ø10 ø27						D046
				Carbide	○		ø10 ø22						
Blind hole boring		STFCR/L	TC...	Steel	○	✓	ø12 ø18						D045
				Carbide	○		ø12 ø18						
Through boring		SSKPR	SP...	Steel	○	✓	ø20 ø31						D041
Boring, un-dercutting & profiling		SYQBR/L	YW...	Steel	○	✓	ø17 ø21.5						D083
				Carbide	○		ø17 ø21.5						
Back boring		SDZCR/L	DC...	Steel	○	✓	ø14 ø25						D085
				Carbide	○		ø18 ø22						
Back boring		SVZCR/L	VC...	Steel	○	✓	ø16						D088
				Carbide	○		ø16						
Back boring		SVZBR/L	VB...	Steel	○	✓	ø20 ø40						D087
				Carbide	○		ø20 ø40						
Internal sphere cutting		SEZPR/L	EP...	Steel	○	✓	ø5.5 ø6.5						D084
				Carbide	○		ø5.5 ø6.5						
Internal sphere cutting		SVJCR/L	VC...	Steel	○	✓	ø16 ø20						D039
				Carbide	○		ø16 ø20						
Internal sphere cutting		SVJBR/L	VB...	Steel	○	✓	ø25 ø30						D038
				Carbide	○		ø25 ø30						



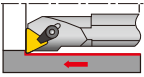

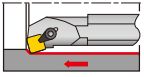



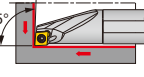

STREAMJETBAR

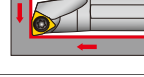
Positive type

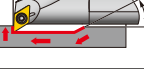
Clamp on

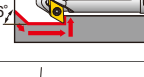
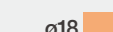
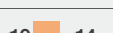
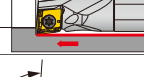
Application	Style	Designation	Insert	Material	Through coolant	ISO Insert	Min. bore diameter DMIN (mm)					Page
							0	10	20	30	40	
Blind hole boring		CTFPR/L	TP... Without hole	Steel		✓						D047
				Carbide								
Through boring		CSKPR/L	SP... Without hole	Steel		✓						D042

Positive double side

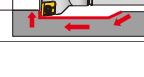
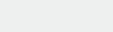
Application	Style	Designation	Insert	Material	Through coolant	TUNGBÄMINI	BOREMEISTER	MINIFÜRN	Min. bore diameter DMIN (mm)					Page
									0	10	20	30	40	
Boring & internal facing		SCLXR/L	CX...	Steel	○			✓						D021
				Carbide										
Boring & internal facing		SWLXR/L	WX...	Steel	○			✓						D023
				Carbide										
Boring & internal profiling		SDXXR/L	DX...	Steel	○			✓						D036
Back boring		SDZXR/L	DX...	Steel	○			✓						D086
				Carbide										
Boring		A/E-SXUOR/L	XOMU	Steel	○	✓								D065
				Carbide										
Boring		TBM	XOMU	Steel	○	✓								D065
Boring & internal profiling		S-SXUOR05-H	XOMU	Steel	○	✓	✓							D066

Grade

Insert

Ext. Toolholder

Int. Toolholder

Threading

Grooving

Miniature tool

Milling cutter

Endmill

Drilling tool

Tooling System

User's Guide

Index

A

B

C

D

E

F

G

H

I

J

K

L

M

Internal Toolholder - Quick Guide

Negative type

Lever lock

Application	Style	Designation	Insert	Material	Through coolant	ISO Insert	ISO FURN	STREAMJETBAR	TUNGJET	Min. bore diameter DMIN (mm)					Page
										20	30	40	50	60	
Boring & internal facing		PCLNR/L	CN..., GN...	Steel Reinforced	○	✓	✓	✓	✓	ø20	ø20	ø63	ø63	D025 - D028	
		PWLNR/L	WN...	Steel	○	✓	✓	✓		ø20		ø50		D031 D032	
Boring & internal profiling		PDUNR/L	DN..., FN...	Steel Reinforced	○	✓	✓	✓	✓	ø25		ø63	ø63	D069 D070	
		PVUNR/L	VN..., YN...	Steel	○	✓	✓	✓			ø37	ø50		D074	
Boring		PTUNR/L	TN...	Steel Reinforced	○	✓	✓	✓		ø20	ø40		ø63	D067	
		PTFNR/L	TN...	Steel	○	✓	✓	✓		ø32			ø63	D049 D050	
Through boring		PSKNR/L	SN...	Steel	○	✓		✓			ø40		ø63	D043	
Back boring		PDZNR/L	DN...	Steel	○	✓		✓			ø40		ø63	D088 D089	

Negative type

Double clamp

Applica- tion	Style	Designation	Insert	Material	Through coolant	ISO Insert			Min. bore diameter DMIN (mm)							Page
						ISO	ISO	TURNING	20	30	40	50	60	70		
Boring & internal facing		ACLNR/L	CN..., GN...	Steel	○	✓	✓	✓	ø32	[Bar chart showing range from 30 to 60 mm]					ø63	D030
		AWLNR/L	WN...	Steel	○	✓	✓	✓	ø32	[Bar chart showing range from 30 to 60 mm]					ø63	D033
Boring & internal profiling		ADUNR/L	DN..., FN...	Steel	○	✓	✓	✓	ø32	[Bar chart showing range from 30 to 60 mm]					ø63	D072
		AVUNR/L	VN...	Steel	○	✓		✓	ø40	[Bar chart showing range from 40 to 50 mm]		ø50	D075			
Boring		ATFNR/L	TN...	Steel	○	✓		✓	ø32	[Bar chart showing range from 32 to 40 mm]		ø40	D051			
		ASKNR/L	SN...	Steel	○	✓		✓	ø32	[Bar chart showing range from 32 to 40 mm]		ø40	D044			

Screw-on

Applica- tion	Style	Designation	Insert	Material	Through coolant	TURNTEC			Min. bore diameter DMIN (mm)						Page	
						TURNTEC	TURNTEC	TURNTEC	40	50	60	70	80	90		
Boring & internal facing		S-TLANR/L	LNMX	Steel	○	✓			ø53	[Bar chart showing range from 53 to 85 mm]					ø85	D040

Grade

Insert

Ext. Toolholder

Int. Toolholder

Threading

Grooving

Miniature tool

Milling cutter

Endmill

Drilling tool

Tooling System

User's Guide

Index





Unique anti-vibration mechanism in the tool body reduces vibration during deep hole boring with long overhangs of up to **L/D = 10**

Vibration Dampening Mechanism

When cutting forces create vibration on boring bar set up with long overhangs, the bar's dampening mechanism counters the tool's motion and cancels the vibration. The dampening mechanism consists of a weight supported by spring elements. The vibrations die out quickly eliminating noise and chatter marks.

- Concept image of dampening

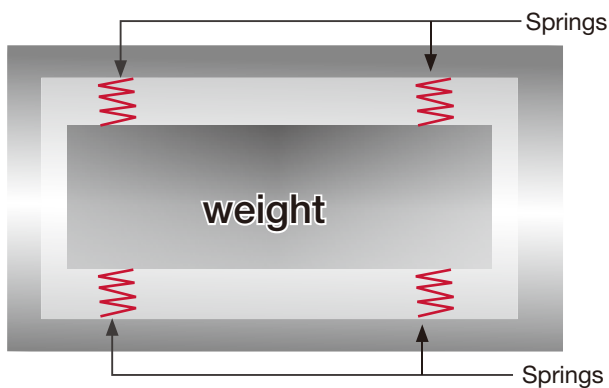

- Tool vibrations with and without vibration damper

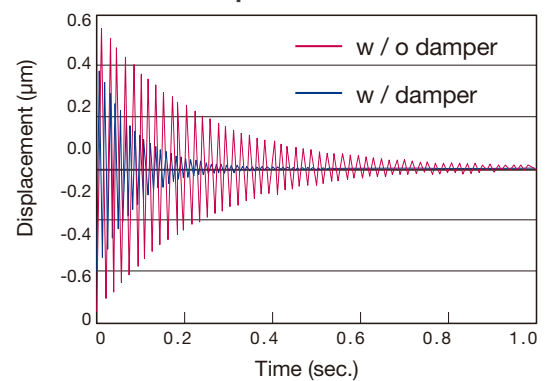

Standard Lineup

BoreMeister is comprised of the anti-vibration bar and interchangeable boring head, featuring serrated interfaces for high precision indexing. They are connected by screws, allowing the fitting of a wide range of cutting heads for great flexibility.

- Minimum bore diameter : ø20 mm

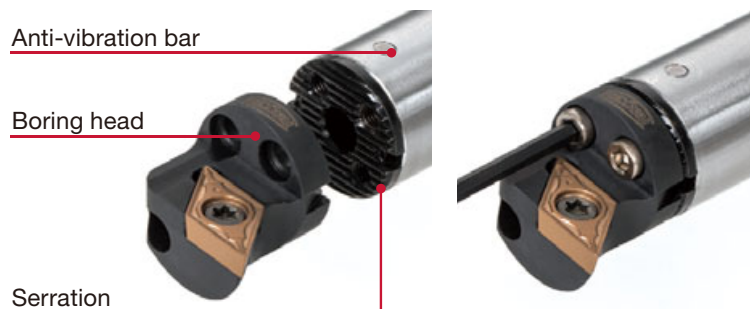

STREAMJETBAR



Engineered for tool strength and optimal chip evacuation

- Tool body of special alloy steel, designed to reduce chatter !

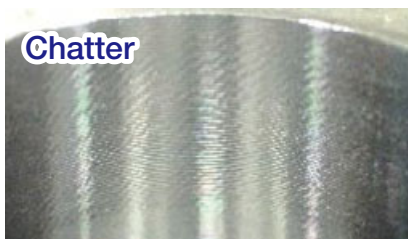

Chatter

Competitor



Excellent surface quality with no chatter

STREAMJETBAR

- Minimum bore diameter from $\varnothing 4.5$ mm
- Steel and carbide shank available
- New pocket design for excellent chip evacuation

Cutting performance

The excellent chip evacuation minimizes tool failure caused by recutting chips and poor chip control. Damage to the work surface from chips is also eliminated.

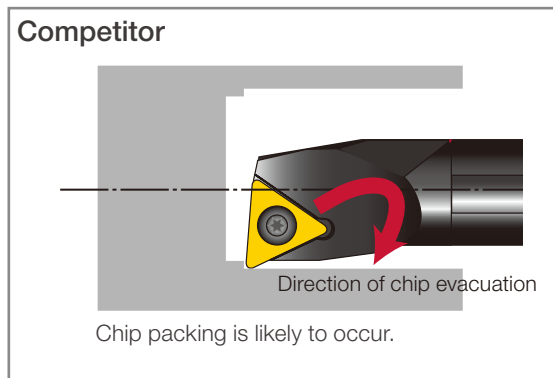
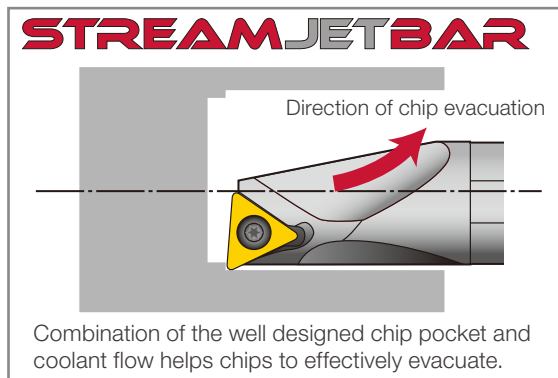

Reference pages: [D014](#), [D018](#), [D025](#), [D031](#), [D034](#), [D036](#), [D038](#), [D041](#), [D043](#), [D045](#), [D046](#), [D049](#), [D052](#), [D053](#), [D056](#), [D058](#), [D059](#), [D061](#), [D067](#), [D069](#), [D074](#), [D076](#), [D078](#), [D079](#), [D081](#), [D084](#), [D085](#), [D087 - D089](#), [D093 - D095](#)

TUNGB^{ORE}MINI



Reduced machine downtime thanks to eliminating the need for tool changes. Multifunctional Tool for Drilling and Turning.

Minimum number of tools for maximum productivity

- A single TungBoreMini tool can handle multiple operations such as ID turning after drilling without exchanging the tools
- Allows drilling and hole enlargement on various materials, instead of using a drill and turning tool
- Can be used just like a standard ISO turning tool for ID, OD, and/or face turning applications

No rotating tools in lathe



Conventional Tooling - 3 Tools

Accelerated Tooling - 1 Tool

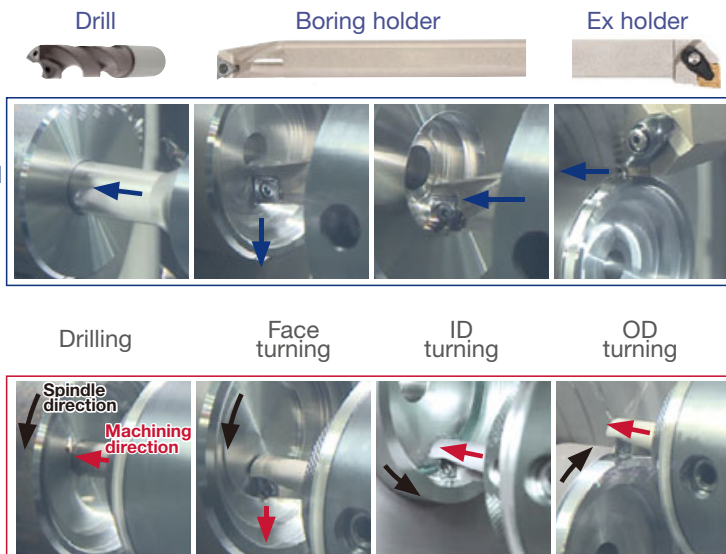

TUNGB^{ORE}MINI



PVD grade: AH725

AH725 features a super tough substrate with a new PVD coating layer.

Special surface technology

PREMIUMTEC

Coating layer with excellent adhesion strength
PVD coating

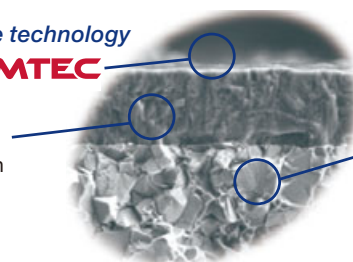

Remarkable toughness
Fine grain carbide

Reference pages: **D065**

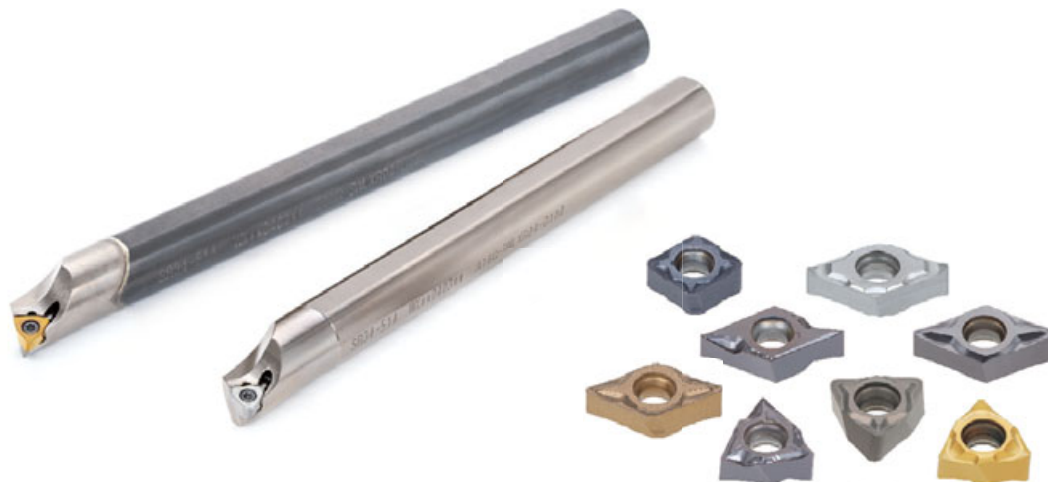

Economical double-sided positive insert

Innovative geometry and seat interface ensures stability and high performance.

Insert

CXMU0603... 4 edges, rhombic 80°

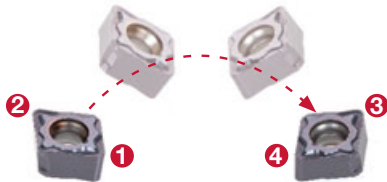

DXM/GU0703... 4 edges, rhombic 55°

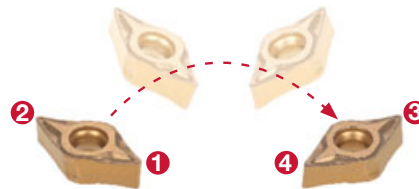

WXGU0403... 6 positive cutting edges

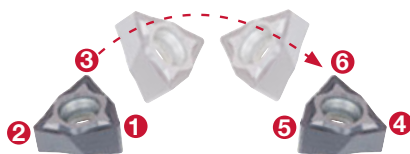

Low cutting force machining with high rake angle

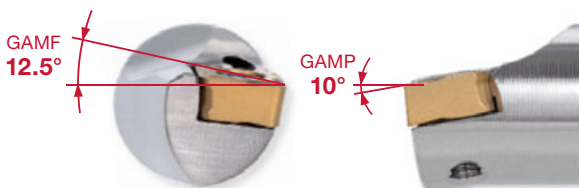

MINIFORCE
A12M-SCLXR06-D140

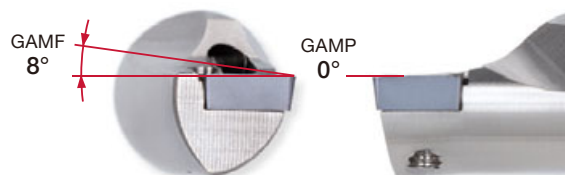

Conventional
A12M-SCLCR06-D140

STREAMJETBAR

A/E-SCLCR/L

Screw-on boring bar, for positive 80° rhombic inserts

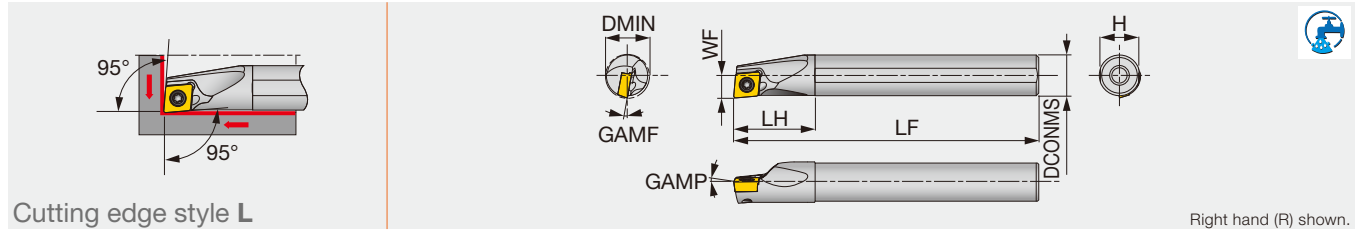

Designation	Material	DMIN	DCONMS	WF	LF	LH	H	GAMP	GAMF	RE**	Insert	Torque*
A04F-SCLCR/L03-D050	Steel	5	4	2.5	80	8	3.8	0°	-15°	0.2	CC**03X1...	0.6
A05F-SCLCR/L03-D060	Steel	6	5	3	80	9	4.8	0°	-13°	0.2	CC**03X1...	0.6
A06G-SCLCR/L04-D070	Steel	7	6	3.5	90	11	5.75	0°	-13°	0.2	CC**04T1...	0.6
A07G-SCLCR/L04-D080	Steel	8	7	4	90	12	6.75	0°	-11°	0.2	CC**04T1...	0.6
A08H-SCLCR/L06-D100	Steel	10	8	5.5	100	16	7.5	0°	-13°	0.4	CC**0602...	1.2
A10F-SCLCR06-D120	Steel	12	10	6	80	20	9	0°	-10°	0.4	CC**0602...	1.2
A10K-SCLCR/L06-D120	Steel	12	10	6	125	20	9	0°	-10°	0.4	CC**0602...	1.2
A12H-SCLCR06-D140	Steel	14	12	7	100	24	11	0°	-8°	0.4	CC**0602...	1.2
A12M-SCLCR/L06-D140	Steel	14	12	7	150	24	11	0°	-8°	0.4	CC**0602...	1.2
A12H-SCLCR06-D160	Steel	16	12	9	100	24	11	0°	-7°	0.4	CC**0602...	1.2
A12M-SCLCR/L06-D160	Steel	16	12	9	150	24	11	0°	-7°	0.4	CC**0602...	1.2
A16K-SCLCR09-D180	Steel	18	16	9	125	32	15	0°	-9°	0.8	CC**09T3...	3
A16Q-SCLCR/L09-D180	Steel	18	16	9	180	32	15	0°	-10°	0.8	CC**09T3...	3
A16K-SCLCR09-D200	Steel	20	16	11	125	32	15	0°	-9°	0.8	CC**09T3...	3
A16Q-SCLCR/L09-D200	Steel	20	16	11	180	32	15	0°	-9°	0.8	CC**09T3...	3
A20R-SCLCR/L09-D220	Steel	22	20	11	200	32	18	0°	-8°	0.8	CC**09T3...	3
A25S-SCLCR/L09-D270	Steel	27	25	13.5	250	45	23	0°	-6°	0.8	CC**09T3...	3
E04G-SCLCR/L03-D050	Carbide	5	4	2.5	90	9	3.8	0°	-15°	0.2	CC**03X1...	0.6
E05G-SCLCR/L03-D060	Carbide	6	5	3	90	10	4.8	0°	-13°	0.2	CC**03X1...	0.6
E06H-SCLCR/L04-D070	Carbide	7	6	3.5	100	12	5.75	0°	-13°	0.2	CC**04T1...	0.6
E07H-SCLCR/L04-D080	Carbide	8	7	4	100	14	6.75	0°	-11°	0.2	CC**04T1...	0.6
E08G-SCLCR06-D100	Carbide	10	8	5.5	90	22	7.5	0°	-13°	0.4	CC**0602...	1.2
E08K-SCLCR/L06-D100	Carbide	10	8	5.5	125	22	7.5	0°	-13°	0.4	CC**0602...	1.2
E10F-SCLCR06-D120	Carbide	12	10	6	80	25	9	0°	-10°	0.4	CC**0602...	1.2
E10H-SCLCR06-D120	Carbide	12	10	6	100	25	9	0°	-10°	0.4	CC**0602...	1.2
E10M-SCLCR/L06-D120	Carbide	12	10	6	150	25	9	0°	-10°	0.4	CC**0602...	1.2
E12G-SCLCR06-D140	Carbide	14	12	7	90	27	11	0°	-8°	0.4	CC**0602...	1.2
E12J-SCLCR06-D140	Carbide	14	12	7	110	27	11	0°	-8°	0.4	CC**0602...	1.2
E12Q-SCLCR/L06-D140	Carbide	14	12	7	180	27	11	0°	-8°	0.4	CC**0602...	1.2
E12G-SCLCR06-D160	Carbide	16	12	9	90	27	11	0°	-7°	0.4	CC**0602...	1.2
E12J-SCLCR06-D160	Carbide	16	12	9	110	27	11	0°	-7°	0.4	CC**0602...	1.2
E12Q-SCLCR/L06-D160	Carbide	16	12	9	180	27	11	0°	-7°	0.4	CC**0602...	1.2
E16H-SCLCR09-D180	Carbide	18	16	9	100	32	15	0°	-10°	0.8	CC**09T3...	3
E16L-SCLCR09-D180	Carbide	18	16	9	130	32	15	0°	-10°	0.8	CC**09T3...	3
E16R-SCLCR/L09-D180	Carbide	18	16	9	200	32	15	0°	-10°	0.8	CC**09T3...	3
E16H-SCLCR09-D200	Carbide	20	16	11	100	32	15	0°	-9°	0.8	CC**09T3...	3
E16L-SCLCR09-D200	Carbide	20	16	11	130	32	15	0°	-9°	0.8	CC**09T3...	3
E16R-SCLCR/L09-D200	Carbide	20	16	11	200	32	15	0°	-9°	0.8	CC**09T3...	3
E20S-SCLCR09-D220	Carbide	22	20	11	250	36	18	0°	-8°	0.8	CC**09T3...	3
E25T-SCLCR09-D270	Carbide	27	25	13.5	300	45	23	0°	-6°	0.8	CC**09T3...	3

*Torque: Recommended clamping torque (N-m)

**RE: Standard corner radius

Note: Use right-hand toolholders (SCLCR**) with left-hand inserts (L); and left-hand toolholders (SCLCL**) with right-hand inserts (R).

Reference pages: A/E-SCLCR/L: Insert → **B112 -**, CBN → **B189 -**, PCD → **B213**

SPARE PARTS



Designation	Clamping screw	Wrench
A**-SCLCR/L03-D...	CSTA-1.6	T-6F
A**-SCLCR/L04-D...	CSTB-2	T-6F
A**-SCLCR/L06-D...	CSTB-2.5S	T-8F
A**-SCLCR/L09-D...	CSTB-4S	T-15F
E**-SCLCR/L03-D...	CSTA-1.6	T-6F
E**-SCLCR/L04-D...	CSTB-2	T-6F
E**-SCLCR/L06-D...	CSTB-2.5S	T-8F
E16**-SCLCR/L09-D...	CSTB-4L060	T-15F
E2**-SCLCR/L09-D...	CSTB-4S	T-15F

INSERT SELECTION

Application	Precision finishing		Finishing		Finishing to medium cutting			
	Grade	SH725	NS9530	SH725	T9215			
Breaker Shape	JP		PSS		JS		PS	
Cutting conditions	B016							

Application	Medium cutting	
Grade	T9215	
Breaker Shape	PM	
Cutting conditions	B016	

Application	Finishing to medium cutting	
Grade	T515	
Breaker Shape	CM	
Cutting conditions	B020	

Application	Precision finishing		Finishing	Finishing to medium cutting		
	Grade	BX470	AH8005	AH8015		
Breaker Shape	CBN		PS		PS	
Cutting conditions	B024					

Application	Precision finishing		Finishing		Finishing to medium cutting			
	Grade	SH725	AH6225	SH725	AH6225			
Chipbreaker shape	JP		PSS		JS		PS	
Cutting conditions	B018							

Application	Medium cutting	
Grade	AH6225	
Chipbreaker shape	PM	
Cutting conditions	B018	

Application	Precision finishing		Finishing	Medium cutting		
	Grade	DX120	DX140	KS05F		
Breaker Shape	DIA		^{with rake} DIA		AL	
Cutting conditions	B022					

Application	Precision finishing		Finishing	
	Grade	BXA10	BXA20	
Breaker Shape	HP		HS	
Cutting conditions	B026			

T-SCLCR/L

Screw-on boring bar, for positive 80° rhombic inserts (Tsuppari-Ichiban)

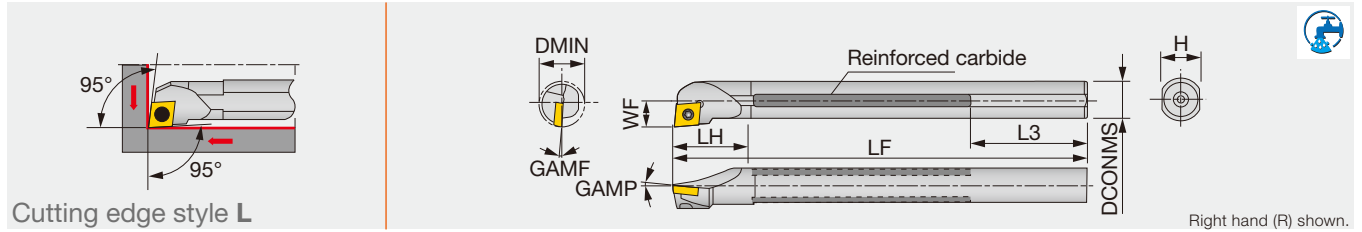

Designation	Material	DMIN	CNT	DCONMS	WF	LF	LH	L3	H	GAMF	GAMP	RE**	Insert	Torque*
T12M-SCLCR/L06	Reinforced	16	—	12	9	150	22	59	11	-10°	0°	0.4	CC**0602...	1.2
T16Q-SCLCR/L09	Reinforced	20	—	16	11	180	27	59	15	-10°	0°	0.8	CC**09T3...	3
T20R-SCLCR/L09C	Reinforced	25	Rc1/4	20	13	200	35	49	18	-8°	0°	0.8	CC**09T3...	3
T25S-SCLCR/L09C	Reinforced	32	Rc1/4	25	17	250	40	64	23	-6°	0°	0.8	CC**09T3...	3

*Torque: Recommended clamping torque (N-m)

**RE: Standard corner radius

*The hole specification of applicable inserts conforms to ISO standard.

Note: Use right-hand toolholders (SCLCR**) with left-hand inserts (L); and left-hand toolholders (SCLCL**) with right-hand inserts (R).

SPARE PARTS

Designation	Clamping screw	Wrench
T12M-SCLCR/L06	CSTB-2.5	T-8F
T16Q-SCLCR/L09	CSTB-4S	T-15F
T20R-SCLCR/L09C	CSTB-4S	T-15F
T25S-SCLCR/L09C	CSTB-4S	T-15F

INSERT SELECTION

P	Application	Precision finishing	Finishing		Finishing to medium cutting
	Grade	SH725	NS9530	SH725	T9215
	Breaker Shape				
	Cutting conditions	B016			
M	Application	Precision finishing	Finishing		Finishing to medium cutting
	Grade	SH725	AH6225	SH725	AH6225
	Chipbreaker shape				
	Cutting conditions	B018			
P	Application	Medium cutting			
	Grade	T9215			
	Breaker Shape				
	Cutting conditions	B016			
M	Application	Medium cutting			
	Grade	AH6225			
	Chipbreaker shape				
	Cutting conditions	B018			
K	Application	Finishing to medium cutting			
	Grade	T515			
	Breaker Shape				
	Cutting conditions	B020			
N	Application	Precision finishing	Finishing	Medium cutting	
	Grade	DX120	DX140	KS05F	
	Breaker Shape				
	Cutting conditions	B022			
S	Application	Precision finishing	Finishing	Finishing to medium cutting	
	Grade	BX470	AH8005	AH8015	
	Breaker Shape				
	Cutting conditions	B024			
H	Application	Precision finishing	Finishing		
	Grade	BXA10	BXA20		
	Breaker Shape				
	Cutting conditions	B026			

Reference pages: T-SCLCR/L: Insert → **B112 -**, CBN → **B189 -**, PCD → **B213**

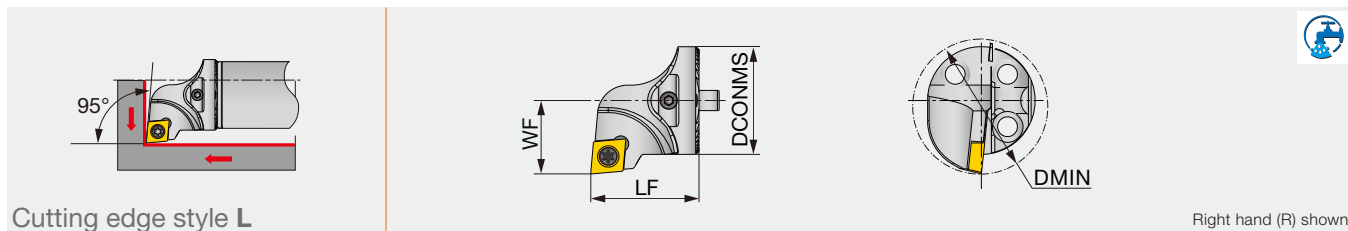

Cutting edge style L

Right hand (R) shown.

Designation	DMIN	DCONMS	WF	LF	Shank	Insert
S16-SCLCR/L06-H	20	16	11	20	D/G16	CC**0602...
S20-SCLCR/L09-H	25	20	13	20	D/G20	CC**09T3...
S25-SCLCR/L09-H	32	25	17	22	D25	CC**09T3...
S32-SCLCR/L09-H	40	32	22	32	D32	CC**09T3...
S40-SCLCR/L12T-H	50	40	27	38	D40, D50, D60	CC**1204...

Note: Use right-hand toolholders (SCLCR**) with left-hand inserts (L); and left-hand toolholders (SCLCL**) with right-hand inserts (R).

Designation	Clamping screw	Wrench	Shim	Shim screw
S16-SCLCR/L06-H	SR14-548	T-7/5	-	-
S20-SCLCR/L09-H	SR16-236	T-15/5	-	-
S25-SCLCR/L09-H	SR16-236	T-15/5	-	-
S32-SCLCR/L09-H	SR16-236	T-15/5	-	-
S40-SCLCR/L12T-H	SR16-212	T-20/5	TCC4-2	SRTC-4

INSERT SELECTION

P	Application	Precision finishing	Finishing		Finishing to medium cutting
	Grade	SH725	NS9530	SH725	T9215
	Breaker Shape	JP	PSS	JS	PS
	Images				
Cutting conditions: B016					
M	Application	Precision finishing	Finishing		Finishing to medium cutting
	Grade	SH725	AH6225	SH725	AH6225
	Chipbreaker shape	JP	PSS	JS	PS
	Images				
Cutting conditions: B018					
P	Application	Medium cutting			
	Grade	T9215			
	Breaker Shape	PM			
	Image				
Cutting conditions: B016					
M	Application	Medium cutting			
	Grade	AH6225			
	Chipbreaker shape	PM			
	Image				
Cutting conditions: B018					
K	Application	Finishing to medium cutting			
	Grade	T515			
	Breaker Shape	CM			
	Image				
Cutting conditions: B020					
N	Application	Precision finishing	Finishing	Medium cutting	
	Grade	DX120	DX140	KS05F	
	Breaker Shape	DIA	with rake DIA	AL	
	Images				
Cutting conditions: B022					
S	Application	Precision finishing	Finishing	Finishing to medium cutting	
	Grade	BX470	AH8005	AH8015	
	Breaker Shape	CBN	PS	PS	
	Images				
Cutting conditions: B024					
H	Application	Precision finishing	Finishing		
	Grade	BXA10	BXA20		
	Breaker Shape	HP	HS		
	Images				
Cutting conditions: B026					

Reference pages: S-SCLCR/L-H: Insert → **B112 -**, CBN → **B189 -**, PCD → **B213**
Shank → **D090 - D092**



STREAMJETBAR

A/E-SCLPR/L

Screw-on boring bar, for positive 80° rhombic inserts

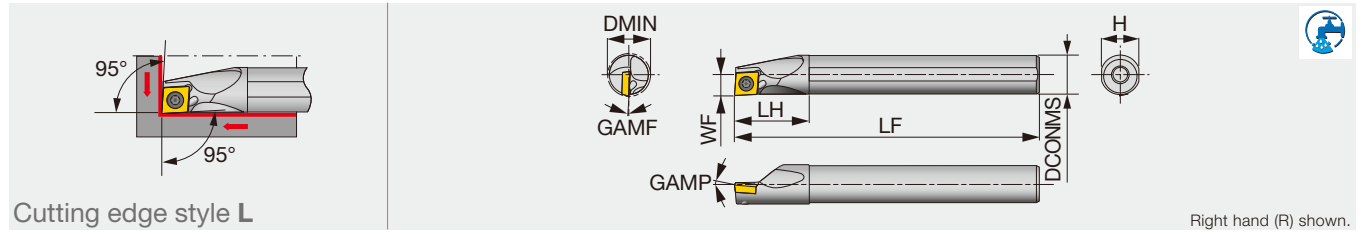

Right hand (R) shown.

Designation	Material	DMIN	DCONMS	WF	LF	LH	H	GAMP	GAMF	RE**	Insert	Torque*
A08H-SCLPR/L06-D100	Steel	10	8	5.5	100	16	7.5	5°	-8°	0.4	CP**0602...	1.2
A10K-SCLPR/L06-D120	Steel	12	10	6	125	20	9	5°	-5°	0.4	CP**0602...	1.2
A10K-SCLPR/L08-D120	Steel	12	10	6	125	20	9	5°	-5°	0.4	CP**0802...	1.4
A12M-SCLPR/L06-D140	Steel	14	12	7	150	24	11	5°	-4°	0.4	CP**0602...	1.2
A12M-SCLPR/L08-D140	Steel	14	12	7	150	24	11	5°	-4°	0.4	CP**0802...	1.4
A12M-SCLPR/L08-D160	Steel	16	12	9	150	24	11	5°	-3°	0.4	CP**0802...	1.4
A16Q-SCLPR/L09-D180	Steel	18	16	9	180	32	15	5°	-3.5°	0.8	CP**0903...	3
A16Q-SCLPR/L09-D200	Steel	20	16	11	180	32	15	5°	-3°	0.8	CP**0903...	3
A20R-SCLPR/L09-D220	Steel	22	20	11	200	36	18	5°	-2°	0.8	CP**0903...	3
A25S-SCLPR/L09-D270	Steel	27	25	13.5	250	45	23	5°	-1°	0.8	CP**0903...	3
E08K-SCLPR/L06-D100	Carbide	10	8	5.5	125	22	7.5	5°	-8°	0.4	CP**0602...	1.2
E10M-SCLPR/L06-D120	Carbide	12	10	6	150	25	9	5°	-5°	0.4	CP**0602...	1.2
E10H-SCLPR08-D120	Carbide	12	10	6	100	25	9	5°	-5°	0.4	CP**0802...	1.4
E10M-SCLPR/L08-D120	Carbide	12	10	6	150	25	9	5°	-5°	0.4	CP**0802...	1.4
E12Q-SCLPR/L06-D140	Carbide	14	12	7	180	27	11	5°	-4°	0.4	CP**0602...	1.2
E12G-SCLPR08-D140	Carbide	14	12	7	90	27	11	5°	-4°	0.4	CP**0802...	1.4
E12J-SCLPR08-D140	Carbide	14	12	7	110	27	11	5°	-4°	0.4	CP**0802...	1.4
E12Q-SCLPR/L08-D140	Carbide	14	12	7	180	27	11	5°	-4°	0.4	CP**0802...	1.4
E12G-SCLPR08-D160	Carbide	16	12	9	90	27	11	5°	-3°	0.4	CP**0802...	1.4
E12J-SCLPR08-D160	Carbide	16	12	9	110	27	11	5°	-3°	0.4	CP**0802...	1.4
E12Q-SCLPR/L08-D160	Carbide	16	12	9	180	27	11	5°	-3°	0.4	CP**0802...	1.4
E16H-SCLPR09-D180	Carbide	18	16	9	100	32	15	5°	-3.5°	0.8	CP**0903...	3
E16L-SCLPR09-D180	Carbide	18	16	9	130	32	15	5°	-3.5°	0.8	CP**0903...	3
E16R-SCLPL09-D180	Carbide	18	16	9	200	32	15	5°	-3.5°	0.8	CP**0903...	3
E16H-SCLPR09-D200	Carbide	20	16	11	100	32	15	5°	-3°	0.8	CP**0903...	3
E16L-SCLPR09-D200	Carbide	20	16	11	130	32	15	5°	-3°	0.8	CP**0903...	3
E16R-SCLPL09-D200	Carbide	20	16	11	200	32	15	5°	-3°	0.8	CP**0903...	3

*Torque: Recommended clamping torque (N·m)

**RE: Standard corner radius

Note: Use right-hand toolholders (SCLPR**) with left-hand inserts (L); and left-hand toolholders (SCLPL**) with right-hand inserts (R).

SPARE PARTS



Designation	Clamping screw	Wrench
A**-SCLPR/L06-D...	CSTB-2.5S	T-8F
A10K-SCLPR/L08-D120	CSTB-3L042	T-9F
A12M-SCLPR/L08-D...	CSTB-3L050	T-9F
A**-SCLPR/L09-D...	CSTB-4L060	T-15F
E**-SCLPR/L06-D...	CSTB-2.5S	T-8F
E10*-SCLPR/L08-D...	CSTB-3L042	T-9F
E12*-SCLPR/L08-D...	CSTB-3L050	T-9F
E16*-SCLPR/L09-D...	CSTB-4L060	T-15F

Reference pages: A/E-SCLPR/L: Insert → **B118 -**, CBN → **B192**

T-SCLPR/L

Screw-on boring bar, for positive 80° rhombic inserts (Tsuppari-Ichiban)

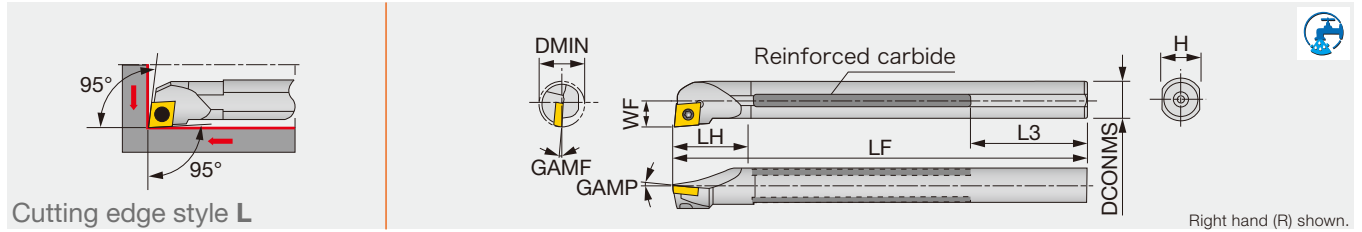

Designation	Material	DMIN	CNT	DCONMS	WF	LF	LH	L3	H	GAMF	GAMP	RE**	Insert	Torque*
T12M-SCLPR08-D14	Reinforced	14	-	12	7	150	22	59	11	-4°	5°	0.4	CP**0802...	1.4
T12M-SCLPR/L08	Reinforced	16	-	12	9	150	25	59	11	-3°	5°	0.4	CP**0802...	1.4
T16Q-SCLPR09-D18	Reinforced	18	-	16	9	180	27	59	15	-3.5°	5°	0.8	CP**0903...	3
T16Q-SCLPR/L09	Reinforced	20	-	16	11	180	30	59	15	-4°	5°	0.8	CP**0903...	3
T20R-SCLPR09C-D22	Reinforced	22	Rc1/4	20	11	200	35	49	18	-2°	5°	0.8	CP**0903...	3
T20R-SCLPR/L09	Reinforced	25	-	20	13	200	35	49	18	-2°	5°	0.8	CP**0903...	3
T25S-SCLPR09C-D27	Reinforced	27	Rc1/4	25	13.5	250	40	64	23	-1°	5°	0.8	CP**0903...	3
T25S-SCLPR/L09	Reinforced	32	-	25	17	250	40	64	23	0°	5°	0.8	CP**0903...	3

*Torque: Recommended clamping torque (N-m)

**RE: Standard corner radius

Note: Use right-hand toolholders (SCLPR**) with left-hand inserts (L); and left-hand toolholders (SCLPL**) with right-hand inserts (R).

SPARE PARTS

Designation	Clamping screw	Wrench
T12M-SCLPR/L08...	CSTB-3L050	T-9F
T16Q-SCLPR09-D18	CSTB-4L060	T-15F
T16Q-SCLPR/L09	CSTB-4S	T-15F
T20R-SCLPR09C-D22	CSTB-4L060	T-15F
T20R-SCLPR/L09	CSTB-4S	T-15F
T25S-SCLPR09C-D27	CSTB-4L060	T-15F
T25S-SCLPR/L09	CSTB-4S	T-15F

INSERT SELECTION

Application	Finishing	Finishing to medium cutting	Medium cutting
	Grade	NS9530	T9215
Breaker Shape	PSS	PS	PM
Images			
Cutting conditions	B016		

Application	Finishing	Finishing to medium cutting	Medium cutting
	Grade	AH6225	AH6225
Chipbreaker shape	PSS	PS	PM
Images			
Cutting conditions	B018		

Application	Finishing to medium cutting
Grade	T515
Breaker Shape	CM
Image	
Cutting conditions	B020

Application	Finishing
Grade	DX140
Breaker Shape	DIA
Image	
Cutting conditions	B022

Application	Finishing	Finishing to medium cutting
	Grade	AH8005
Breaker Shape	PSS	PS
Images		
Cutting conditions	B024	

Reference pages: T-SCLPR/L: Insert → B118 -, CBN → B192



Screw-on clamp exchangeable boring head, for positive 35° rhombic inserts

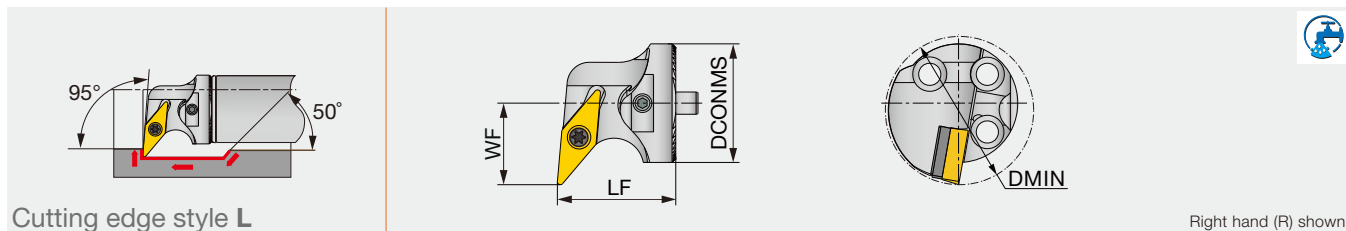

Cutting edge style L

Right hand (R) shown.

Designation	DMIN	DCONMS	WF	LF	Shank	Insert
S32-SVLCR/L16T-H	40	32	22	32	D32	VC**1604...
S40-SVLCR/L16T-H	50	40	27	32	D40, D50, D60	VC**1604...

Note: Use right-hand toolholders (SVLCR**) with left-hand inserts (L); and left-hand toolholders (SVLCL**) with right-hand inserts (R).

SPARE PARTS				
Designation	Clamping screw	Wrench	Shim	Shim screw
S32-SVLCR/L16T-H	SR16-236P	T-15/5	TVC 3-1P	SRTC-3P
S40-SVLCR/L16T-H	SR16-236P	T-15/5	TVC 3-1P	SRTC-3P

INSERT SELECTION

P	Application	Finishing	Finishing to medium cutting
	Grade	NS9530	T9215
	Breaker Shape	PSS	PS
Cutting conditions		B016	

M	Application	Finishing	Finishing to medium cutting
	Grade	AH6225	AH6225
	Chipbreaker shape	PSS	PS
Cutting conditions		B018	

K	Application	Finishing to medium cutting
	Grade	T515
	Breaker Shape	CM
Cutting conditions		B020

N	Application	Precision finishing	Finishing	Medium cutting
	Grade	DX120	DX140	KS05F
	Breaker Shape	DIA	with rake DIA	AL
Cutting conditions		B022		

S	Application	Finishing	Finishing to medium cutting
	Grade	AH8005	AH8015
	Breaker Shape	PS	PS
Cutting conditions		B024	

H	Application	Precision finishing	Finishing
	Grade	BXA10	BXA20
	Breaker Shape	CBN	CBN
Cutting conditions		B026	

Reference pages: S-SVLCR/L-H: Insert → **B152 -**, CBN → **B209**, PCD → **B220**
Shank → **D090 - D092**

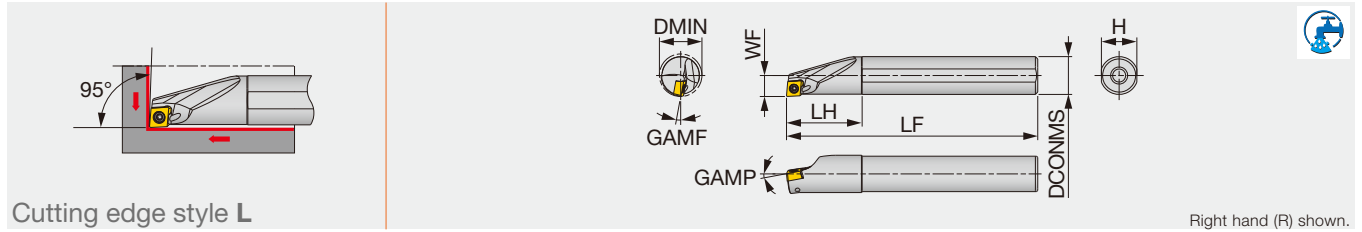

Designation	Material	DMIN	DCONMS	WF	LF	LH	H	GAMP	GAMP	RE**	Insert	Torque*
A10K-SCLXR/L06-D120	Steel	12	10	6	125	20	9	-10°	-14.5°	0.4	CXMU0603**L/R...	0.9
A12M-SCLXR/L06-D140	Steel	14	12	7	150	24	11	-10°	-12.5°	0.4	CXMU0603**L/R...	0.9
A16Q-SCLXR/L06-D180	Steel	18	16	9	180	32	15	-10°	-9.5°	0.4	CXMU0603**L/R...	0.9
A20R-SCLXR/L06-D220	Steel	22	20	11	200	36	18	-10°	-8°	0.4	CXMU0603**L/R...	0.9
E10M-SCLXR/L06-D120	Carbide	12	10	6	150	25	9	-10°	-14.5°	0.4	CXMU0603**L/R...	0.9
E12Q-SCLXR/L06-D140	Carbide	14	12	7	180	27	11	-10°	-12.5°	0.4	CXMU0603**L/R...	0.9
E16R-SCLXR/L06-D180	Carbide	18	16	9	200	32	15	-10°	-9.5°	0.4	CXMU0603**L/R...	0.9
E20S-SCLXR/L06-D220	Carbide	22	20	11	250	36	18	-10°	-8°	0.4	CXMU0603**L/R...	0.9

*Torque: Recommended clamping torque (N-m) **RE: Standard corner radius
Use right-hand toolholders (R) with left-hand inserts (L); and left-hand toolholders (L) with right-hand inserts (R).

SPARE PARTS		
Designation	Clamping screw	Wrench
A/E**SCLXR/L...	SR34-514	T-7F

- 1 Use the right hand toolholder (R) for the left hand insert (L)
- 2 Use the left hand toolholder (L) for the right hand insert (R)



1 Right hand toolholder with left hand insert shown



2 Left hand toolholder with right hand insert shown

INSERT SELECTION

P	Application	Finishing to medium cutting	Medium cutting	M	Application	Finishing to medium cutting	Medium cutting
	Grade	T9215	T9215		Grade	AH8015	AH8015
Breaker Shape	TS	TS	Breaker Shape	TS	TS	TS	
Cutting conditions				Cutting conditions			
B096				B096			
K	Application	Finishing to medium cutting	Medium cutting	S	Application	Finishing to medium cutting	Medium cutting
	Grade	T9215	T9215		Grade	AH8015	AH8015
Breaker Shape	TS	TS	Breaker Shape	TS	TS	TS	
Cutting conditions				Cutting conditions			
B096				B096			

Reference pages: A/E-SCLXR/L: Insert → B120
Standard cutting conditions → D096

Screw-on clamp exchangeable boring head, for CXMU inserts

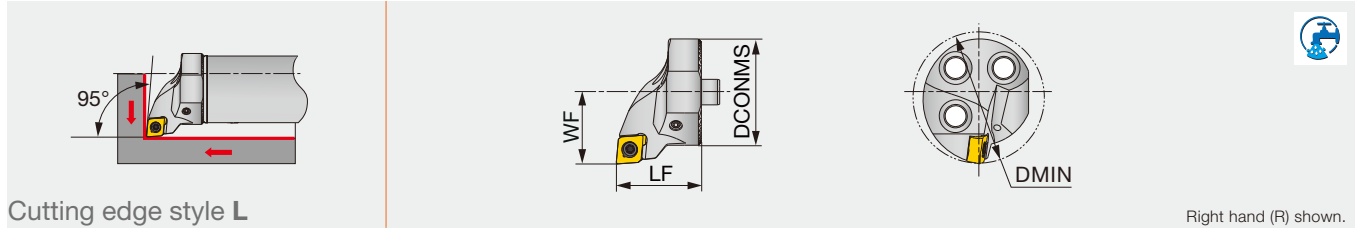

Cutting edge style L

Right hand (R) shown.

Designation	DMIN	DCONMS	WF	LF	Shank	Insert
S25-SCLXR/L06-H	32	25	17	20	D25	CXMU0603**L/R...
S32-SCLXR/L06-H	40	32	22	32	D32	CXMU0603**L/R...
S40-SCLXR/L06-H	50	40	27	32	D40, D50, D60	CXMU0603**L/R...

Note: Use right-hand toolholders (SCLXR**) with left-hand inserts (L); and left-hand toolholders (SCLXL**) with right-hand inserts (R).

SPARE PARTS

Designation	Clamping screw	Wrench
S**-SCLXR/L06-H	SR34-514	T-7F

INSERT SELECTION

Application	Finishing to medium cutting		Medium cutting
	Grade	Grade	
Grade	T9215	T9215	T9215
Breaker Shape	TS	TS	TS
Cutting conditions B096			

Application	Finishing to medium cutting		Medium cutting
	Grade	Grade	
Grade	AH8015	AH8015	AH8015
Breaker Shape	TS	TS	TS
Cutting conditions B096			

Application	Finishing to medium cutting		Medium cutting
	Grade	Grade	
Grade	T9215	T9215	T9215
Breaker Shape	TS	TS	TS
Cutting conditions B096			

Application	Finishing to medium cutting		Medium cutting
	Grade	Grade	
Grade	AH8015	AH8015	AH8015
Breaker Shape	TS	TS	TS
Cutting conditions B096			

Reference pages: S-SCLXR/L-H: Insert → **B120**, Shank → **D090 - D092**
Standard cutting conditions → **D096**

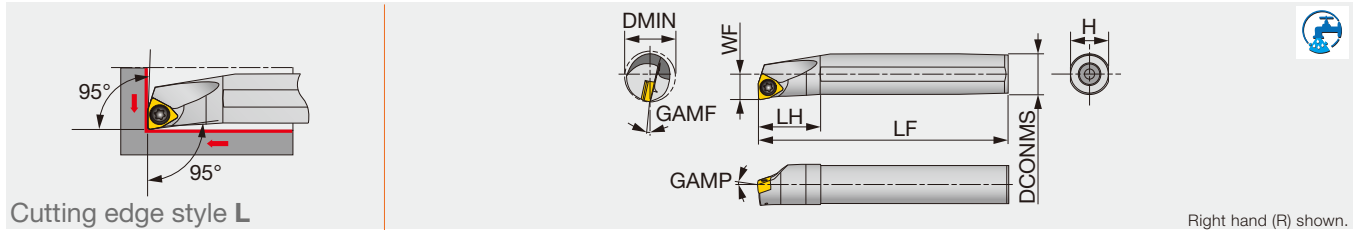

Right hand (R) shown.

Designation	Material	DMIN	DCONMS	WF	LF	LH	H	GAMP	GAMP	RE**	Insert	Torque*
A10K-SWLXR/L04-D120	Steel	12	10	6	125	20	9	-10°	-16°	0.4	WXGU0403**L/R...	0.9
A12M-SWLXR/L04-D140	Steel	14	12	7	150	24	11	-10°	-14°	0.4	WXGU0403**L/R...	0.9
A16Q-SWLXR/L04-D180	Steel	18	16	9	180	32	15	-10°	-11°	0.4	WXGU0403**L/R...	0.9
A20R-SWLXR/L04-D220	Steel	22	20	11	200	36	18	-10°	-10°	0.4	WXGU0403**L/R...	0.9
E10M-SWLXR/L04-D120	Carbide	12	10	6	150	25	9	-10°	-16°	0.4	WXGU0403**L/R...	0.9
E12Q-SWLXR/L04-D140	Carbide	14	12	7	180	27	11	-10°	-14°	0.4	WXGU0403**L/R...	0.9
E16R-SWLXR/L04-D180	Carbide	18	16	9	200	32	15	-10°	-11°	0.4	WXGU0403**L/R...	0.9
E20S-SWLXR/L04-D220	Carbide	22	20	11	250	36	18	-10°	-10°	0.4	WXGU0403**L/R...	0.9

*Torque: Recommended clamping torque (N-m) **RE: Standard corner radius

Note: Use right-hand toolholders (R) with left-hand inserts (L); and left-hand toolholders (L) with right-hand inserts (R)

SPARE PARTS

Designation	Clamping screw	Wrench
A/E**-SWLXR/L...	SR34-514	T-7F

INSERT SELECTION

P	Application	Precision finishing	Finishing		Finishing to medium cutting
	Grade	SH725	SH725	NS9530	AH8015
	Breaker Shape	JS	JTS	SS	TS
	Cutting conditions	B096			
M	Application	Precision finishing	Finishing		Finishing to medium cutting
	Grade	SH725	SH725	AH8015	AH8015
	Breaker Shape	JS	JTS	SS	TS
	Cutting conditions	B096			
P	Application	Medium cutting			
	Grade	AH8015			
	Breaker Shape	TS			
	Cutting conditions	B096			
M	Application	Medium cutting			
	Grade	AH8015			
	Breaker Shape	TS			
	Cutting conditions	B096			
K	Application	Precision finishing	Finishing		Finishing to medium cutting
	Grade	SH725	SH725	NS9530	AH8015
	Breaker Shape	JS	JTS	SS	TS
	Cutting conditions	B096			
N	Application	Finishing	Finishing to medium cutting	Medium cutting	
	Grade	KS05F	KS05F	KS05F	
	Breaker Shape	SS	TS	TS	
	Cutting conditions	B096			
K	Application	Medium cutting			
	Grade	AH8015			
	Breaker Shape	TS			
	Cutting conditions	B096			
S	Application	Precision finishing	Finishing		Finishing to medium cutting
	Grade	SH725	SH725	AH8015	AH8015
	Breaker Shape	JS	JTS	SS	TS
	Cutting conditions	B096			
H	Application	Finishing	Finishing to medium cutting	Medium cutting	
	Grade	BXA10	BXA20	BXA20	
	Breaker Shape	HP			
	Cutting conditions	B096			
S	Application	Medium cutting			
	Grade	AH8015			
	Breaker Shape	TS			
	Cutting conditions	B096			

Reference pages: A/E-SWLXR/L: Insert → **B157** -

Standard cutting conditions → **D096**

Screw-on clamp exchangeable boring head, for WXGU inserts

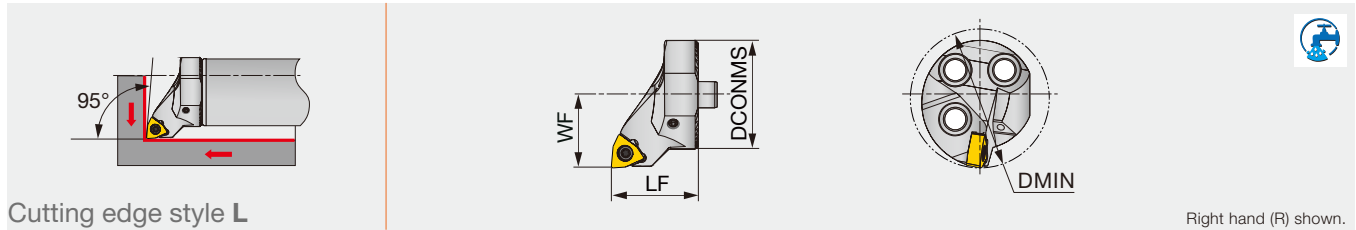

Cutting edge style L

Right hand (R) shown.

Designation	DMIN	DCONMS	WF	LF	Shank	Insert
S25-SWLXR/L04-H	32	25	17	20	D25	WXGU...
S32-SWLXR/L04-H	40	32	22	32	D32	WXGU...
S40-SWLXR/L04-H	50	40	27	32	D40, D50, D60	WXGU...

Note: Use right-hand toolholders (SWLXR**) with left-hand inserts (L); and left-hand toolholders (SWLXL**) with right-hand inserts (R).

SPARE PARTS

Designation	Clamping screw	Wrench
S**-SWLXR/L04-H	SR34-514	T-7F

INSERT SELECTION

P	Application	Precision finishing	Finishing		Finishing to medium cutting
	Grade	SH725	SH725	NS9530	AH8015
	Breaker Shape	JS	JTS	SS	TS
	Cutting conditions	B096			
M	Application	Precision finishing	Finishing		Finishing to medium cutting
	Grade	SH725	SH725	AH8015	AH8015
	Breaker Shape	JS	JTS	SS	TS
	Cutting conditions	B096			
P	Application	Medium cutting			
	Grade	AH8015			
	Breaker Shape	TS			
	Cutting conditions	B096			
M	Application	Medium cutting			
	Grade	AH8015			
	Breaker Shape	TS			
	Cutting conditions	B096			
K	Application	Precision finishing	Finishing		Finishing to medium cutting
	Grade	SH725	SH725	NS9530	AH8015
	Breaker Shape	JS	JTS	SS	TS
	Cutting conditions	B096			
N	Application	Finishing	Finishing to medium cutting	Medium cutting	
	Grade	KS05F	KS05F	KS05F	
	Breaker Shape	SS	TS	TS	
	Cutting conditions	B096			
K	Application	Medium cutting			
	Grade	AH8015			
	Breaker Shape	TS			
	Cutting conditions	B096			
S	Application	Precision finishing	Finishing		Finishing to medium cutting
	Grade	SH725	SH725	AH8015	AH8015
	Breaker Shape	JS	JTS	SS	TS
	Cutting conditions	B096			
H	Application	Finishing	Finishing to medium cutting	Medium cutting	
	Grade	BXA10	BXA20	BXA20	
	Breaker Shape	HP	CBN	CBN	
	Cutting conditions	B096			
S	Application	Medium cutting			
	Grade	AH8015			
	Breaker Shape	TS			
	Cutting conditions	B096			

Reference pages: S-SWLXR/L-H: Insert → **B157 -**, Shank → **D090 - D092**
Standard cutting conditions → **D096**

STREAMJETBAR

A-PCLNR/L

Lever-lock boring bar, for negative 80°/70° rhombic inserts

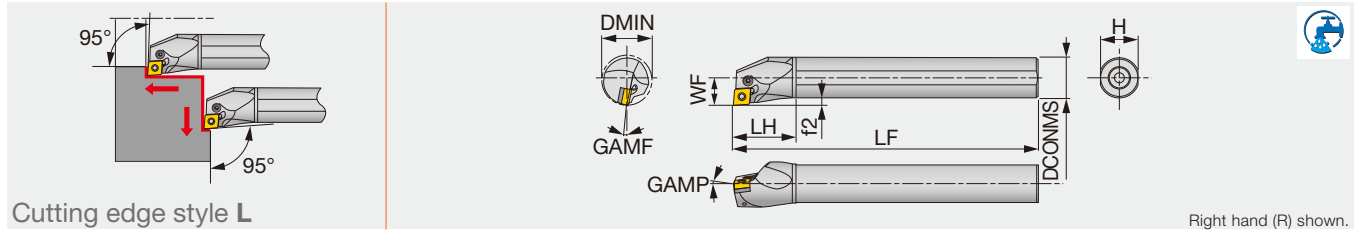

Cutting edge style L

Right hand (R) shown.

Designation	Material	DMIN	DCONMS	WF	LF	LH	H	f2	GAMP	GAMF	RE**	Insert	Torque*
A16M-PCLNR/L0904-D200	Steel	20	16	11	150	32	15	3	-6°	-16°	0.8	CN**/GNMG0904...	1.7
A20Q-PCLNR/L0904-D250	Steel	25	20	13	180	36	18	3	-6°	-12°	0.8	CN**/GNMG0904...	1.7
A16M-PCLNR/L09-D200	Steel	20	16	11	150	32	15	3	-6°	-14°	0.8	CN**0903...	1.7
A20Q-PCLNR/L09-D250	Steel	25	20	13	180	36	18	3	-6°	-12°	0.8	CN**0903...	1.7
A25R-PCLNR/L09-D320	Steel	32	25	17	200	45	23	4.5	-6°	-11°	0.8	CN**0903...	1.7
A25R-PCLNR/L12-D320	Steel	32	25	17	200	45	23	4.5	-6°	-13°	0.8	CN**/GNGA1204...	2.7
A32S-PCLNR/L12-D400	Steel	40	32	22	250	50	30	6	-6°	-11°	0.8	CN**/GNGA1204...	4.8
A40T-PCLNR/L12-D500	Steel	50	40	27	300	60	37	7	-6°	-10°	0.8	CN**/GNGA1204...	4.8
A50U-PCLNR/L12-D630	Steel	63	50	35	350	65	47	10	-6°	-8°	0.8	CN**/GNGA1204...	4.8

*Torque: Recommended clamping torque (N-m)

**RE: Standard corner radius

Note: Use right-hand toolholders (PCLNR**) with left-hand inserts (L); and left-hand toolholders (PCLNL**) with right-hand inserts (R).

SPARE PARTS

Designation	Shim	Clamping screw 1	Clamping screw 2	Wrench 1	Wrench 2	Spring pin	Lever	Oil supply attachment*	Screw for oil hole*
A16M-PCLNR/L0904-D200	-	-	LCS33	P-2F	-	-	LCL33N	-	SSHM3-4
A20Q-PCLNR/L0904-D250	-	-	LCS33	P-2F	-	-	LCL33N	EA-20	SSHM3-4
A**-PCLNR/L09-D**0	-	LCS22A	-	P-2F	-	-	LCL32N	EA-25	SSHM5-6
A25R-PCLNR/L12-D320	-	LCS43	-	-	P-2.5	-	LCL43N	EA-25	SSHM5-6
A32S-PCLNR12-D400	LSC42BR	-	LCS4	-	P-3	LSP4	LCL4	EA-32	SSHM5-6
A32S-PCLNL12-D400	LSC42BL	-	LCS4	-	P-3	LSP4	LCL4	-	SSHM6-6
A40T-PCLNR12-D500	LSC42BR	-	LCS4	-	P-3	LSP4	LCL4	-	SSHM6-6
A40T-PCLNL12-D500	LSC42BL	-	LCS4	-	P-3	LSP4	LCL4	-	SSHM6-6
A50U-PCLNR12-D630	LSC42BR	-	LCS4	-	P-3	LSP4	LCL4	-	SSHM6-6
A50U-PCLNL12-D630	LSC42BL	-	LCS4	-	P-3	LSP4	LCL4	-	SSHM6-6

*Optional

INSERT SELECTION

P	Application	Precision finishing	Finishing	Medium cutting	Medium to heavy cutting
	Grade	NS9530	GT9530	T9215	T9215
	Breaker Shape	TF	TSF	TM	TH
	Cutting conditions	B004			
M	Application	Finishing	Medium cutting	Medium to heavy cutting	
	Grade	T6215	AH6225	AH6225	
	Chipbreaker shape	SF	SM	SH	
	Cutting conditions	B006			
K	Application	Finishing	Medium cutting	Medium to heavy cutting	
	Grade	T515	T515	T515	
	Breaker Shape	All-round	All-round	All-round	
	Cutting conditions	B008			
N	Application	Precision finishing	Finishing	Medium cutting	
	Grade	DX120	DX140	TH10	
	Breaker Shape	DIA	with rake DIA	P	
	Cutting conditions	B010			
S	Application	Precision finishing	Finishing	Medium cutting	
	Grade	BX815	AH8005	AH8005	
	Breaker Shape	CBN	HRF	HRM	
	Cutting conditions	B012			
H	Application	Precision finishing	Finishing		
	Grade	BXA10	BXA20		
	Breaker Shape	HP	HS		
	Cutting conditions	B014			

Reference pages: A-PCLNR/L: Insert → B054 -, B075, CBN → B168 -, PCD → B211



Lever-lock boring bar with TungCap connection, with 95° approach angle, for negative 80°/70° rhombic inserts, with high pressure coolant capability

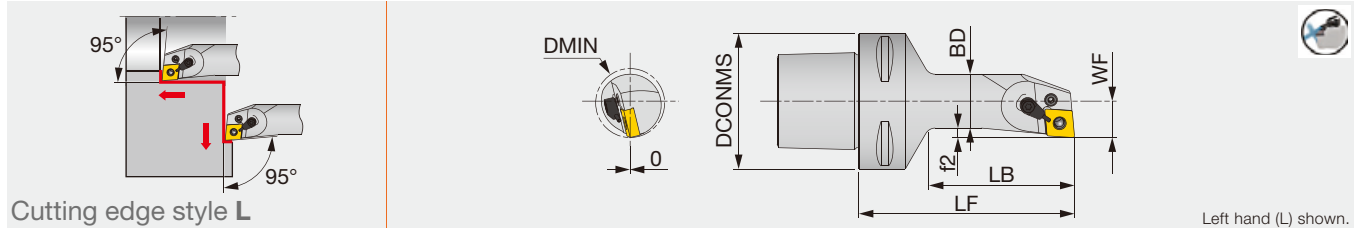

Designation	DMIN	DCONMS	BD	LF	LB	WF	f2	RE**	Insert
C6PCLNL17100-12-CHP	32	63	25	100	67.5	17	4.5	0.8	CN**/GNGA1204...

Applicable for 14 MPa coolant
**RE: Standard corner radius

SPARE PARTS

Designation	Clamping screw	Coolant unit	Wrench	Lever
C6PCLNL17100-12-CHP	LCS43	S-CU-CHP	P-2.5F	LCL43N

INSERT SELECTION

Application	Precision finishing	Finishing	Medium cutting	Medium to heavy cutting
	Grade	NS9530	GT9530	T9215
Breaker Shape	TF	TSF	TM	TH
Cutting conditions	B004			

Application	Finishing	Medium cutting	Medium to heavy cutting
	Grade	T6215	AH6225
Chipbreaker shape	SF	SM	SH
Cutting conditions	B006		

Application	Finishing	Medium cutting	Medium to heavy cutting
	Grade	T515	T515
Breaker Shape	All-round	All-round	All-round
Cutting conditions	B008		

Application	Precision finishing	Finishing	Medium cutting
	Grade	DX120	DX140
Breaker Shape	DIA	with rake DIA	P
Cutting conditions	B010		

Application	Precision finishing	Finishing	Medium cutting
	Grade	BX815	AH8005
Breaker Shape	CBN	HRF	HRM
Cutting conditions	B012		

Application	Precision finishing	Finishing
	Grade	BXA10
Breaker Shape	HP	HS
Cutting conditions	B014	

Reference pages: C-PCLNL-CHP: Insert → **B054** -, CBN → **B168** -, PCD → **B211**

S-PCLNR/L

Lever-lock boring bar, for negative 80°/70° rhombic inserts

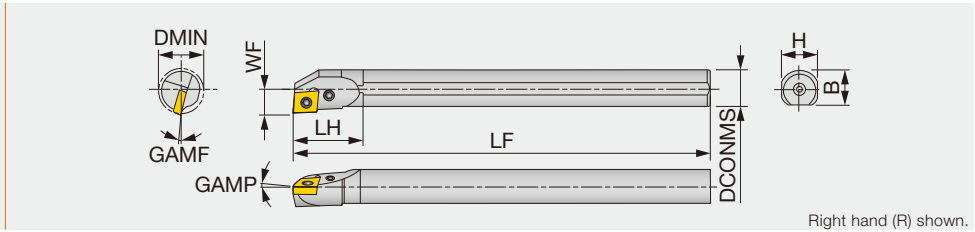
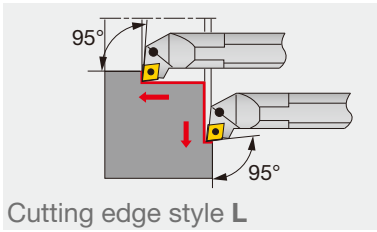

Designation	Material	DMIN	DCONMS	WF	LF	LH	H	B	GAMP	GAMF	RE**	Insert	Torque*
S16M-PCLNR/L09	Steel	20	16	11	150	30	15	15.5	-6°	-14°	0.8	CN**0903...	1.7
S20Q-PCLNR/L09	Steel	25	20	13	180	35	18	19	-6°	-12°	0.8	CN**0903...	1.7
S25R-PCLNR/L09	Steel	32	25	17	200	40	23	24	-6°	-11°	0.8	CN**0903...	1.7
S32S-PCLNR/L12	Steel	40	32	22	250	50	30	29.5	-6°	-11°	0.8	CN**/GNGA1204...	4.8
S40T-PCLNR/L12	Steel	50	40	27	300	55	37	37.5	-6°	-10°	0.8	CN**/GNGA1204...	4.8
S50U-PCLNR/L12	Steel	63	50	35	350	65	47	47.5	-6°	-8°	0.8	CN**/GNGA1204...	4.8

*Torque: Recommended clamping torque (N·m)

**RE: Standard corner radius

Note: Use right-hand toolholders (R) with left-hand inserts (L); and left-hand toolholders (L) with right-hand inserts (R).

SPARE PARTS

Designation	Shim	Clamping screw 1	Clamping screw 2	Wrench 1	Wrench 2	Spring pin	Lever
S**-PCLNR/L09	-	LCS22A	-	P-2F	-	-	LCL32N
S32S-PCLNR/L12	LSC42BR/L	-	LCS4	-	P-3	LSP4	LCL4
S40T-PCLNR/L12	LSC42BR/L	-	LCS4	-	P-3	LSP4	LCL4
S50U-PCLNR/L12	LSC42BR/L	-	LCS4	-	P-3	LSP4	LCL4

INSERT SELECTION

Application	Precision finishing	Finishing	Medium cutting	Medium to heavy cutting
	Grade	NS9530	GT9530	T9215
Breaker Shape	TF	TSF	TM	TH
Cutting conditions	B004			

Application	Finishing	Medium cutting	Medium to heavy cutting
	Grade	T6215	AH6225
Chipbreaker shape	SF	SM	SH
Cutting conditions	B006		

Application	Finishing	Medium cutting	Medium to heavy cutting
	Grade	T515	T515
Breaker Shape	All-round	All-round	All-round
Cutting conditions	B008		

Application	Precision finishing	Finishing	Medium cutting
	Grade	DX120	DX140
Breaker Shape	DIA	with rake DIA	P
Cutting conditions	B010		

Application	Precision finishing	Finishing	Medium cutting
	Grade	BX815	AH8005
Breaker Shape	CBN	HRF	HRM
Cutting conditions	B012		

Application	Precision finishing	Finishing
	Grade	BXA10
Breaker Shape	HP	HS
Cutting conditions	B014	

Reference pages: S-PCLNR/L: Insert → B054 -, CBN → B168 -, PCN → B211

Grade
Insert
Ext. Toolholder
Int. Toolholder
Threading
Grooving
Miniature tool
Milling cutter
Endmill
Drilling tool
Tooling System
User's Guide
Index



T-PCLNR

Lever-lock boring bar, for negative 80°/70° rhombic inserts (Tsupari-Ichiban)

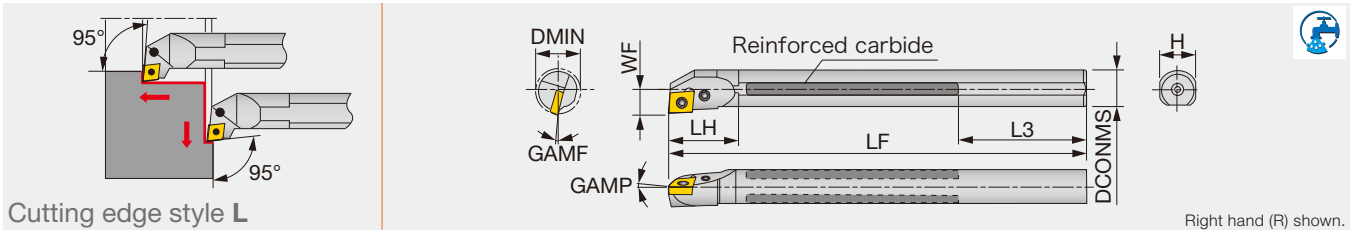

Cutting edge style L

Right hand (R) shown.

Designation	Material	DMIN	CNT	DCONMS	WF	LF	LH	L3	H	GAMP	GAMF	RE**	Insert	Torque*
T16Q-PCLNR09	Reinforced	20	-	16	11	180	27	59	15	-6°	-14°	0.8	CN**0903...	1.7
T20R-PCLNR09C	Reinforced	25	Rc1/4	20	13	200	35	49	18	-6°	-12°	0.8	CN**0903...	1.7
T25S-PCLNR09C	Reinforced	32	Rc1/4	25	17	250	40	64	23	-6°	-11°	0.8	CN**0903...	1.7
T32U-PCLNR12C	Reinforced	40	Rc1/2	32	22	350	50	103	30	-6°	-11°	0.8	CN**/GNGA1204...	4.8
T40V-PCLNR12C	Reinforced	50	Rc1/2	40	27	400	55	88	37	-6°	-10°	0.8	CN**/GNGA1204...	4.8
T50W-PCLNR12C	Reinforced	63	Rc1/2	50	35	450	65	63	47	-6°	-8°	0.8	CN**/GNGA1204...	4.8

*Torque: Recommended clamping torque (N-m)

**RE: Standard corner radius

Note: Use right-hand toolholders (R) with left-hand inserts (L); and left-hand toolholders (L) with right-hand inserts (R).

SPARE PARTS

Designation	Shim	Clamping screw 1	Clamping screw 2	Wrench 1	Wrench 2	Spring pin	Lever
T**-PCLNR09...	-	LCS22A	-	P-2F	-	-	LCL32N
T**-PCLNR12C	LSC42BR	-	LCS4	-	P-3	LSP4	LCL4

INSERT SELECTION

Application	Precision finishing	Finishing	Medium cutting	Medium to heavy cutting
	Grade	NS9530	GT9530	T9215
Breaker Shape	TF	TSF	TM	TH
Cutting conditions	B004			

Application	Finishing	Medium cutting	Medium to heavy cutting
	Grade	T6215	AH6225
Chipbreaker shape	SF	SM	SH
Cutting conditions	B006		

Application	Finishing	Medium cutting	Medium to heavy cutting
	Grade	T515	T515
Breaker Shape	All-round	All-round	All-round
Cutting conditions	B008		

Application	Precision finishing	Finishing	Medium cutting
	Grade	DX120	DX140
Breaker Shape	DIA	with rake DIA	P
Cutting conditions	B010		

Application	Precision finishing	Finishing	Medium cutting
	Grade	BX815	AH8005
Breaker Shape	CBN	HRF	HRM
Cutting conditions	B012		

Application	Precision finishing	Finishing
	Grade	BXA10
Breaker Shape	HP	HS
Cutting conditions	B014	

Reference pages: T-PCLNR: Insert → B054 -, CBN → B168 -, PCD → B211

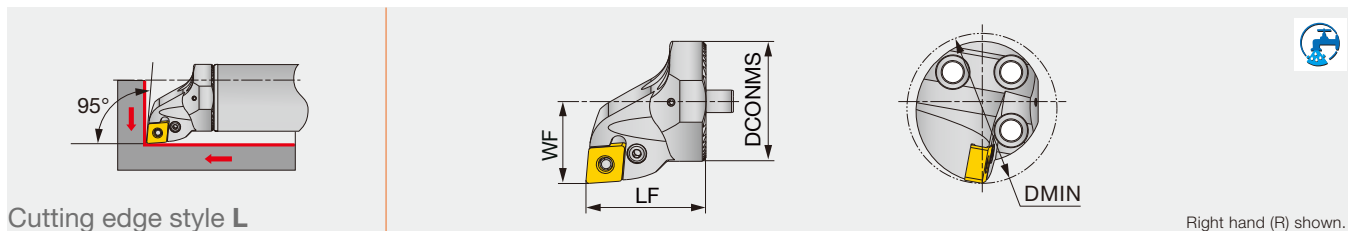

Cutting edge style L

Right hand (R) shown.

Designation	DMIN	DCONMS	WF	LF	Shank	Insert
S32-PCLNR/L09-H	40	32	22	32	D32	CN**/GNMG0904...
S40-PCLNR/L09-H	50	40	27	32	D40, D50, D60	CN**/GNMG0904...

Note: Use right-hand toolholders (PCLNR**) with left-hand inserts (L); and left-hand toolholders (PCLNL**) with right-hand inserts (R).

SPARE PARTS

Designation	Lever	Clamping screw	Shim	Spring pin	Wrench
S32-PCLNR/L09-H	LCL33N	LCS33	-	-	P-2F
S40-PCLNR/L09-H	LCL33	LCS3	LSC317	LSP3	P-2.5

INSERT SELECTION

P	Application	Finishing	Medium cutting
	Grade	T9215	T9215
	Chipbreaker shape	TSF	TM
	Cutting conditions	B004	

M	Application	Finishing	Medium cutting
	Grade	AH6225	AH6225
	Chipbreaker shape	SS	SM
	Cutting conditions	B006	

K	Application	Medium cutting
	Grade	T515
	Chipbreaker shape	TM
	Cutting conditions	B008

S	Application	Medium cutting
	Grade	AH8015
	Chipbreaker shape	TM
	Cutting conditions	B012

Reference pages: S-PCLNR/L-H: Insert → **B054 - B075**, CBN → **B168 -**, PCD → **B211**
Shank → **D090 - D092**



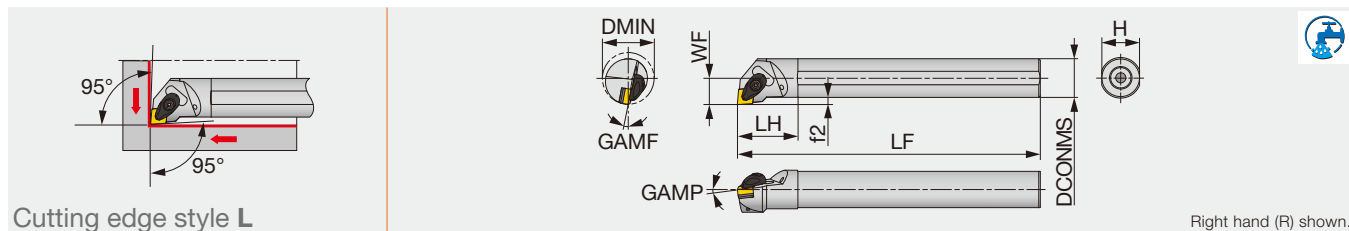

Cutting edge style L

Right hand (R) shown.

Designation	Material	DMIN	DCONMS	WF	LF	LH	H	f2	GAMP	GAMF	RE**	Insert	Torque*
A25R-ACLNR/L0904-D320	Steel	32	25	17	200	45	23	4.5	-6°	-13°	0.8	CN**/GNMG0904...	3
A32S-ACLNR/L0904-D400	Steel	40	32	22	250	50	30	6	-6°	-10°	0.8	CN**/GNMG0904...	3
A25R-ACLNR/L12-D320	Steel	32	25	17	200	45	23	4.5	-6°	-13°	0.8	CN**/GNGA1204...	3
A32S-ACLNR/L12-D400	Steel	40	32	22	250	50	30	6	-6°	-10°	0.8	CN**/GNGA1204...	3
A40T-ACLNR/L12-D500	Steel	50	40	27	300	55	37	7	-6°	-8°	0.8	CN**/GNGA1204...	3
A50U-ACLNR12-D630	Steel	63	50	35	350	65	47	10	-6°	-7°	0.8	CN**/GNGA1204...	3

*Torque: Recommended clamping torque (N-m)

**RE: Standard corner radius

SPARE PARTS

Designation	Clamp	Clamp screw	Spring	Spring pin	Shim	Shim screw	Wrench
A**-ACLNR/L0904-D...	ACP3S-E	ACS-5W	BP-7	SP-2.5	ASC322	CSTB-3.5	T-15F
A**-ACLNR/L12-D...	ACP4S	ACS-5W	BP-7	SP-2.5	ASC422	CSTB-3.5	T-15F

INSERT SELECTION

Application	Precision finishing	Finishing	Medium cutting	Medium to heavy cutting
	Grade	Grade	Grade	Grade
Grade	NS9530	GT9530	T9215	T9215
Breaker Shape	TF	TSF	TM	TH
Cutting conditions	B004			

Application	Finishing	Medium cutting	Medium to heavy cutting
	Grade	Grade	Grade
Grade	T6215	AH6225	AH6225
Chipbreaker shape	SF	SM	SH
Cutting conditions	B006		

Application	Finishing	Medium cutting	Medium to heavy cutting
	Grade	Grade	Grade
Grade	T515	T515	T515
Breaker Shape	All-round	All-round	All-round
Cutting conditions	B008		

Application	Precision finishing	Finishing	Medium cutting
	Grade	Grade	Grade
Grade	DX120	DX140	TH10
Breaker Shape	DIA	with rake DIA	P
Cutting conditions	B010		

Application	Precision finishing	Finishing	Medium cutting
	Grade	Grade	Grade
Grade	BX815	AH8005	AH8005
Breaker Shape	CBN	HRF	HRM
Cutting conditions	B012		

Application	Precision finishing	Finishing
	Grade	Grade
Grade	BXA10	BXA20
Breaker Shape	HP	HS
Cutting conditions	B014	

Reference pages: A-ACLNR/L: Insert → [B054 -](#), [B075](#), CBN → [B168 -](#), PCD → [B211](#)

STREAMJETBAR

A-PWLNRL

Lever-lock boring bar, for negative 80° trigon inserts

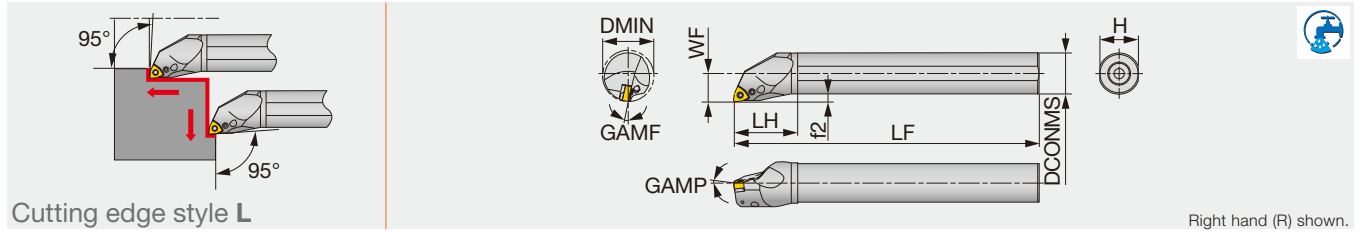

Cutting edge style L

Right hand (R) shown.

Designation	Material	DMIN	DCONMS	WF	LF	LH	H	f2	GAMP	GAMF	RE**	Insert	Torque*
A16M-PWLNRL/L0604-D200	Steel	20	16	11	150	32	15	3	-8°	-17°	0.8	WN**0604...	1.7
A20Q-PWLNRL/L0604-D250	Steel	25	20	13	180	36	18	3	-6°	-14°	0.8	WN**0604...	1.7
A16M-PWLNRL/L06-D200	Steel	20	16	11	150	32	15	3	-8°	-17°	0.8	WN**0604...	1.7
A20Q-PWLNRL/L06-D250	Steel	25	20	13	180	36	18	3	-6°	-14°	0.8	WN**0604...	1.7
A25R-PWLNRL/L06-D320	Steel	32	25	17	200	45	23	4.5	-6°	-12°	0.8	WN**0604...	2.7
A32S-PWLNRL/L06-D400	Steel	40	32	22	250	50	30	6	-6°	-11°	0.8	WN**0604...	2.7
A25R-PWLNRL/L08-D320	Steel	32	25	17	200	45	23	4.5	-6°	-13°	0.8	WN**0804...	2.7
A32S-PWLNRL/L08-D400	Steel	40	32	22	250	50	30	6	-6°	-11°	0.8	WN**0804...	4.8
A40T-PWLNRL/L08-D500	Steel	50	40	27	300	60	37	7	-6°	-10°	0.8	WN**0804...	4.8

*Torque: Recommended clamping torque (N-m) **RE: Standard corner radius

Note: Use right-hand toolholders (PWLNRL**) with left-hand inserts (L); and left-hand toolholders (PWLNL**) with right-hand inserts (R).

SPARE PARTS

Designation	Shim	Clamping screw 1	Clamping screw 2	Wrench 1	Wrench 2	Spring pin	Lever	Oil supply attachment*	Screw for oil hole*
A16M-PWLNRL/L0604-D200	-	-	LCS33	P-2F	-	-	LCL33N	-	SSHM3-4
A20Q-PWLNRL/L0604-D250	-	-	LCS33	P-2F	-	-	LCL33N	EA-20	SSHM3-4
A16M-PWLNRL/L06-D200	-	LCS33	-	P-2F	-	-	LCL33N	-	SSHM3-4
A20Q-PWLNRL/L06-D250	-	LCS33	-	P-2F	-	-	LCL33N	EA-20	SSHM3-4
A25R-PWLNRL/L06-D320	LSW312BR/L	-	LCS3B	-	P-2.5	LSP3	LCL3	EA-25	SSHM4-5
A32S-PWLNRL/L06-D400	LSW312BR/L	-	LCS3	-	P-2.5	LSP3	LCL3	EA-32	SSHM4-5
A25R-PWLNRL/L08-D320	-	LCS43	-	-	P-2.5	-	LCL43N	EA-25	SSHM4-5
A32S-PWLNRL/L08-D400	LSW42BR/L	-	LCS4	-	P-3	LSP4	LCL4	EA-32	SSHM4-5
A40T-PWLNRL/L08-D500	LSW42BR/L	-	LCS4	-	P-3	LSP4	LCL4	-	SSHM4-5

*Optional

INSERT SELECTION

P	Application	Precision finishing	Finishing	Medium cutting	Medium to heavy cutting	M	Application	Finishing	Medium cutting	Medium to heavy cutting
	Grade	NS9530	GT9530	T9215	T9215		Grade	T6215	AH6225	AH6225
	Breaker Shape	TF	TSF	TM	TH		Breaker Shape	SF	SM	SH
	Cutting conditions	B004					Cutting conditions	B006		
K	Application	Finishing	Medium cutting	Medium to heavy cutting		S	Application	Precision finishing	Finishing	Medium cutting
	Grade	T515	T515	T515			Grade	BX480	AH8005	AH8005
	Breaker Shape	All-round	All-round	All-round			Breaker Shape	CBN	HRF	HRM
	Cutting conditions	B008					Cutting conditions	B012		
H	Application	Precision finishing	Finishing							
	Grade	BXM10	BXM20							
	Breaker Shape	CBN	CBN							
	Cutting conditions	B014								

Reference pages: A-PWLNRL: Insert → B102 -, CBN → B187



S-PWLNLR/L

Lever-lock boring bar, for negative 80° trigon inserts

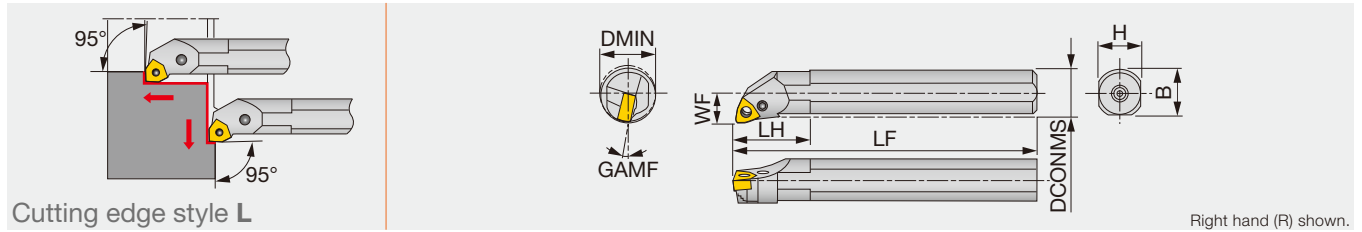

Designation	Material	DMIN	DCONMS	WF	LF	LH	H	B	GAMF	RE**	Insert
S16M-PWLNLR/L06	Steel	20	16	11	150	30	15	15.5	-17°	0.8	WN**0604...
S20Q-PWLNLR/L06	Steel	25	20	13	180	35	18	19	-14°	0.8	WN**0604...
S25R-PWLNLR/L06	Steel	32	25	17	200	40	23	24	-12°	0.8	WN**0604...

**RE : Standard corner radius

Note: Use right-hand toolholders (R) with left-hand inserts (L); and left-hand toolholders (L) with right-hand inserts (R).

Designation	Shim	Clamping screw 1	Clamping screw 2	Wrench 1	Wrench	Spring pin	Lever
S**-PWLNLR/L06	-	LCS33	-	P-2F	-	-	LCL33N
S25R-PWLNLR06	LSW312BR	-	LCS3B	-	P-2.5	LSP3	LCL3
S25R-PWLNLR06	LSW312BL	-	LCS3B	-	P-2.5	LSP3	LCL3

- L
- X
- J
- A
- K
- F
- U
- Q
- Z
- OTHERS

INSERT SELECTION

P

Application	Finishing	Medium cutting
Grade	T9215	T9215
Breaker Shape	TSF	TM
Cutting conditions	B004	

M

Application	Finishing	Medium cutting
Grade	AH6225	AH6225
Chipbreaker shape	SS	SM
Cutting conditions	B006	

K

Application	Medium cutting
Grade	T515
Breaker Shape	TM
Cutting conditions	B008

Reference pages: A-PWLNLR/L: Insert → B102 -, CBN → B187

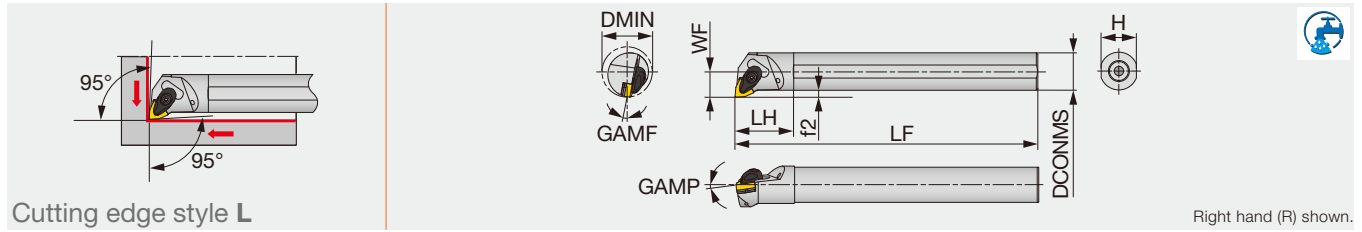

Designation	Material	DMIN	DCONMS	WF	LF	LH	H	f2	GAMP	GAMF	RE**	Insert	Torque*
A25R-AWLNR/L0604-D320	Steel	32	25	17	200	45	23	4.5	-6°	-13°	0.8	WN**0604...	3
A32S-AWLNR/L0604-D400	Steel	40	32	22	250	50	30	6	-6°	-10°	0.8	WN**0604...	3
A25R-AWLNR/L06-D320	Steel	32	25	17	200	45	23	4.5	-6°	-13°	0.8	WN**0604...	3
A32S-AWLNR/L06-D400	Steel	40	32	22	250	50	30	6	-6°	-10°	0.8	WN**0604...	3
A25R-AWLNR/L08-D320	Steel	32	25	17	200	45	23	4.5	-6°	-13°	0.8	WN**0804...	3
A32S-AWLNR/L08-D400	Steel	40	32	22	250	50	30	6	-6°	-10°	0.8	WN**0804...	3
A40T-AWLNR/L08-D500	Steel	50	40	27	300	55	37	7	-6°	-8°	0.8	WN**0804...	3
A50U-AWLNR/L08-D630	Steel	63	50	35	350	65	47	10	-6°	-7°	0.8	WN**0804...	3

*Torque: Recommended clamping torque (N-m)

**RE: Standard corner radius

SPARE PARTS

Designation	Clamp	Clamp screw	Spring	Spring pin	Shim	Shim screw	Wrench
A*-AWLNR/L0604-D...	ACP3S-E	ACS-5W	BP-7	SP-2.5	ASW322	CSTB-3.5	T-15F
A**-AWLNR/L06-D...	ACP3S	ACS-5W	BP-7	SP-2.5	ASW322	CSTB-3.5	T-15F
A**-AWLNR/L08-D...	ACP4S	ACS-5W	BP-7	SP-2.5	ASW422	CSTB-3.5	T-15F

INSERT SELECTION

P	Application	Precision finishing	Finishing	Medium cutting	Medium to heavy cutting	M	Application	Finishing	Medium cutting	Medium to heavy cutting		
	Grade	NS9530	GT9530	T9215	T9215		Grade	SF	T6215	SM	AH6225	AH6225
	Breaker Shape						Breaker Shape					
	Cutting conditions	B004					Cutting conditions	B006				
K	Application	Finishing	Medium cutting	Medium to heavy cutting	S	Application	Precision finishing	Finishing	Medium cutting			
	Grade	T515	T515	T515		Grade	BX480	AH8005	AH8005			
	Breaker Shape	All-round	All-round	All-round		Breaker Shape	CBN	HRF	HRM			
	Cutting conditions	B008				Cutting conditions	B012					
H	Application	Precision finishing	Finishing	M	Application	Precision finishing	Finishing	Medium cutting				
	Grade	BXM10	BXM20		Grade	BX480	AH8005	AH8005				
	Breaker Shape	CBN	CBN		Breaker Shape	CBN	HRF	HRM				
	Cutting conditions	B014			Cutting conditions	B012						

Reference pages: A-AWLNR/L: Insert → **B102** -, CBN → **B187**



STREAMJETBAR

A/E-SEXPR/L

Screw-on boring bar, for positive 75° rhombic inserts

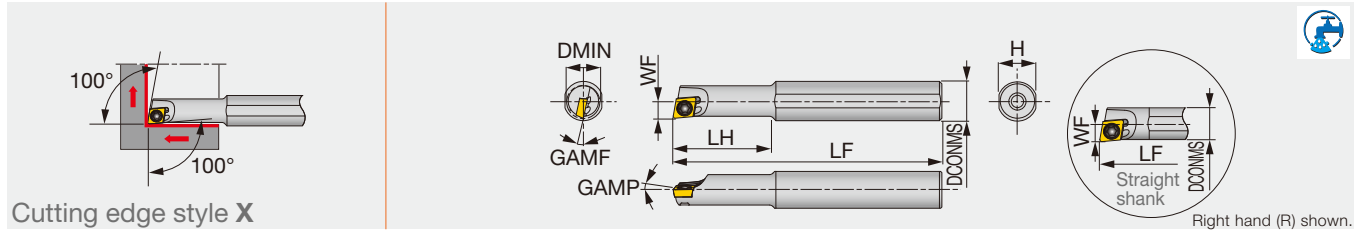

Designation	Material	DMIN	DCONMS	WF	LF	LH	H	GAMP	GAMF	RE**	Insert	Torque*
A04F-SEXPR/L03-D045	Steel	4.5	4	2.3	80	8	3.8	0°	-15°	0.2	EP**03X1...	0.6
A04F-SEXPR/L03-D050	Steel	5	4	2.5	80	8	3.8	0°	-13°	0.2	EP**03X1...	0.6
A05F-SEXPR/L04-D055	Steel	5.5	5	2.75	80	9	4.8	0°	-12°	0.4	EP**0401...	0.6
A06G-SEXPR/L04-D070	Steel	7	6	3.6	90	11	5.75	0°	-12°	0.4	EP**0401...	0.6
A08H-SEXPR/L04-D055	Steel	5.5	8	2.75	100	16	7.5	0°	-12°	0.4	EP**0401...	0.6
A08H-SEXPR/L04-D070	Steel	7	8	3.6	100	20	7.5	0°	-12°	0.4	EP**0401...	0.6
E04G-SEXPR/L03-D045	Carbide	4.5	4	2.3	90	9	3.8	0°	-15°	0.2	EP**03X1...	0.6
E04G-SEXPR/L03-D050	Carbide	5	4	2.5	90	9	3.8	0°	-13°	0.2	EP**03X1...	0.6
E05G-SEXPR/L04-D055	Carbide	5.5	5	2.75	90	10	4.8	0°	-12°	0.4	EP**0401...	0.6
E06H-SEXPR/L04-D070	Carbide	7	6	3.6	100	12	5.75	0°	-12°	0.4	EP**0401...	0.6
E08K-SEXPR/L04-D055	Carbide	5.5	8	2.75	125	28	7.5	0°	-12°	0.4	EP**0401...	0.6
E08K-SEXPR/L04-D070	Carbide	7	8	3.6	125	40	7.5	0°	-12°	0.4	EP**0401...	0.6

*Torque: Recommended clamping torque (N-m)

**RE : Standard corner radius

Note: Use right-hand toolholders (SEXPR**) with left-hand inserts (L); and left-hand toolholders (SEXPL**) with right-hand inserts (R).

Designation	Clamping screw	Wrench
A**-SEXPR/L03-D...	CSTA-1.6	T-6F
A**-SEXPR/L04-D...	CSTB-2	T-6F
E**-SEXPR/L03-D...	CSTA-1.6	T-6F
E**-SEXPR/L04-D...	CSTB-2	T-6F

INSERT SELECTION

Application	Finishing	Application	Finishing	Application	Finishing	Application	Finishing
Grade	SH725	Grade	SH725	Grade	SH725	Grade	SH725
Breaker Shape		Breaker Shape		Breaker Shape		Breaker Shape	
Cutting conditions	B016	Cutting conditions	B018	Cutting conditions	B020	Cutting conditions	B024
Application	Precision finishing	Application	Precision finishing	Application	Precision finishing	Application	Precision finishing
Grade	DX140	Grade	BX310	Grade	CBN	Grade	CBN
Breaker Shape	DIA JS	Breaker Shape		Breaker Shape		Breaker Shape	
Cutting conditions	B022	Cutting conditions	B026	Cutting conditions	B026	Cutting conditions	B026

Reference pages: A/E-SEXPR/L: Insert → **B128** -, CBN → **B195**, PCD → **B214**

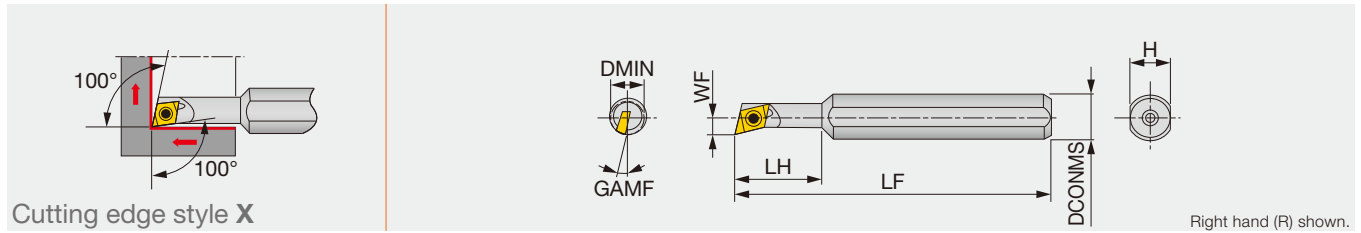

Designation	Material	DMIN	DCONMS	WF	LF	LH	H	GAMF	RE**	Insert	Torque*
JS08H-SEXPR045	Steel	5.5	8	2.7	100	16	7	12°	0.4	EP**0401...	0.6
JS08H-SEXPR047	Steel	7	8	3.6	100	20	7	12°	0.4	EP**0401...	0.6

SPARE PARTS

Designation	Clamping screw	Wrench
JS08H-SEXPR04...	CSTB-2	T-6F

*Torque: Recommended clamping torque (N·m)

**RE : Standard corner radius

Note: Use right-hand toolholders (SEXPR**) with left-hand inserts (L); and left-hand toolholders (SEXPL**) with right-hand inserts (R).

INSERT SELECTION

P	Application	Finishing	M	Application	Finishing	K	Application	Finishing	S	Application	Finishing
	Grade	SH725		Grade	SH725		Grade	SH725		Grade	SH725
	JS			JS			JS			JS	
	Breaker Shape			Breaker Shape			Breaker Shape			Breaker Shape	
	Cutting conditions	B016		Cutting conditions	B018		Cutting conditions	B020		Cutting conditions	B024
N	Application	Precision finishing	Finishing	H	Application	Precision finishing					
	Grade	DX140	SH725		Grade	BX310					
	DIA		JS		CBN						
	Breaker Shape			Breaker Shape							
	Cutting conditions	B022		Cutting conditions	B026						



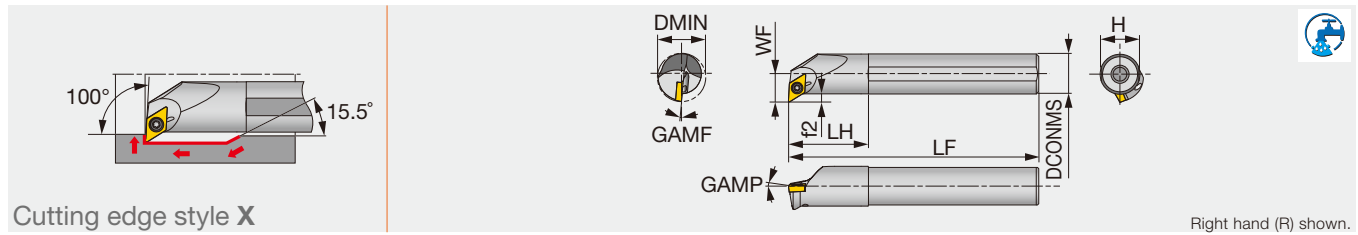

Cutting edge style X

Right hand (R) shown.

Designation	Material	DMIN	DCONMS	WF	LF	LH	H	f2	GAMP	GAMF	RE**	Insert	Torque*
A10K-SDXXR/L07-D130	Steel	13	10	7.6	125	20	9	2.6	-14°	-16°	0.4	DXG/MU0703**L/R...	0.9
A12M-SDXXR/L07-D160	Steel	16	12	8.6	150	24	11	2.6	-14°	-14°	0.4	DXG/MU0703**L/R...	0.9
A16Q-SDXXR/L07-D200	Steel	20	16	10.6	180	32	15	2.6	-13°	-13°	0.4	DXG/MU0703**L/R...	0.9
A20R-SDXXR/L07-D240	Steel	24	20	12.6	200	36	18	2.6	-13°	-12°	0.4	DXG/MU0703**L/R...	0.9
E10M-SDXXR/L07-D130	Carbide	13	10	7.6	150	25	9	2.6	-14°	-16°	0.4	DXG/MU0703**L/R...	0.9
E12Q-SDXXR/L07-D160	Carbide	16	12	8.6	180	27	11	2.6	-14°	-14°	0.4	DXG/MU0703**L/R...	0.9
E16R-SDXXR/L07-D200	Carbide	20	16	10.6	200	32	15	2.6	-13°	-13°	0.4	DXG/MU0703**L/R...	0.9
E20S-SDXXR/L07-D240	Carbide	24	20	12.6	250	36	18	2.6	-13°	-12°	0.4	DXG/MU0703**L/R...	0.9

*Torque: Recommended clamping torque (N-m) **RE : Standard corner radius

Note: Use right-hand toolholders (R) with left-hand inserts (L); and left-hand toolholders (L) with right-hand inserts (R)

SPARE PARTS

Designation	Clamping screw	Wrench
A/E**-SDXXR/L...	SR34-514	T-7F

S-SDXXR/L-H

Screw-on clamp exchangeable boring head, for DXG/MU inserts

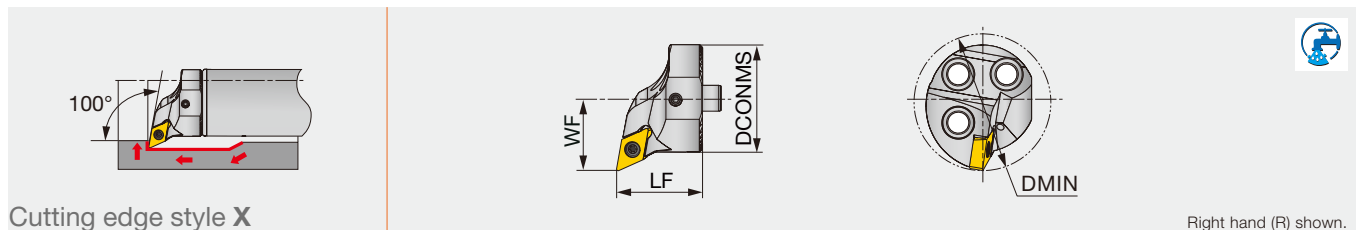

Cutting edge style X

Right hand (R) shown.





Designation	DMIN	DCONMS	WF	LF	Shank	Insert
S25-SDXXR/L07-H	32	25	17	20	D25	DXG/MU0703**L/R...
S32-SDXXR/L07-H	40	32	22	32	D32	DXG/MU0703**L/R...
S40-SDXXR/L07-H	50	40	27	32	D40, D50, D60	DXG/MU0703**L/R...





Note: Use right-hand toolholders (SDXXR**) with left-hand inserts (L); and left-hand toolholders (SDXXL**) with right-hand inserts (R).

SPARE PARTS

Designation	Clamping screw	Wrench
S**-SDXXR/L07-H	SR34-514	T-7F





INSERT SELECTION



P	Application	Precision finishing	Finishing		Finishing to medium cutting
	Grade	SH725	SH725	NS9530	T9215
	Breaker Shape	JS 	JTS 	SS 	TS 
	Cutting conditions	B096			

M	Application	Precision finishing	Finishing		Finishing to medium cutting
	Grade	SH725	SH725	AH8015	AH8015
	Chipbreaker shape	JS 	JTS 	SS 	TS 
	Cutting conditions	B096			





P	Application	Medium cutting
	Grade	T9215
	Breaker Shape	TS 
	Cutting conditions	B096

M	Application	Medium cutting
	Grade	AH8015
	Chipbreaker shape	TS 
	Cutting conditions	B096

K	Application	Precision finishing	Finishing		Finishing to medium cutting
	Grade	SH725	SH725	NS9530	T9215
	Breaker Shape	JS 	JTS 	SS 	TS 
	Cutting conditions	B096			

N	Application	Finishing	Finishing to medium cutting	Medium cutting
	Grade	KS05F	KS05F	KS05F
	Breaker Shape	SS 	TS 	TS 
	Cutting conditions	B096		

K	Application	Medium cutting
	Grade	T9215
	Breaker Shape	TS 
	Cutting conditions	B096

S	Application	Precision finishing	Finishing		Finishing to medium cutting
	Grade	SH725	SH725	AH8015	AH8015
	Breaker Shape	JS 	JTS 	SS 	TS 
	Cutting conditions	B096			

S	Application	Medium cutting
	Grade	AH8015
	Breaker Shape	TS 
	Cutting conditions	B096

Grade
Insert
Ext. Toolholder
Int. Toolholder
Threading
Grooving
Miniature tool
Milling cutter
Endmill
Drilling tool
Tooling System
User's Guide
Index



STREAMJETBAR

A-SVJBR/L

Screw-on boring bar, for positive 35° rhombic inserts

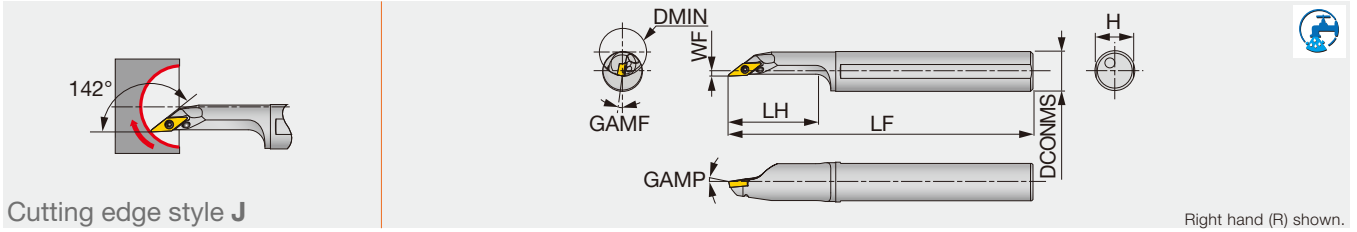

Designation	Material	DMIN	DCONMS	WF	LF	LH	H	GAMP	GAMF	RE**	Insert	Torque*
A20R-SVJBR/L11-D250	Steel	25	20	2	200	40	18	-5°	-5°	0.4	VB**1103...	1.2
A25S-SVJBR/L11-D300	Steel	30	25	3.5	250	50	23	-5°	-5°	0.4	VB**1103...	1.2

*Torque: Recommended clamping torque (N-m)

**RE : Standard corner radius

Note: Use right-hand toolholders (SVJBR**) with left-hand inserts (L); and left-hand toolholders (SVJBL**) with right-hand inserts (R).

SPARE PARTS

Designation	Clamping screw	Wrench
A**-SVJB*11-D...	CSTB-2.5	T-8F

INSERT SELECTION

Application	Precision finishing	Finishing		Finishing to medium cutting
	Grade	SH725	SH725	NS9530
Breaker Shape	JP	JS	PSS	PS
Cutting conditions	B014			

Application	Precision finishing	Finishing		Finishing to medium cutting
	Grade	SH725	SH725	AH6225
Chipbreaker shape	JP	JS	PSS	PS
Cutting conditions	B016			

Application	Medium cutting
Grade	T9215
Breaker Shape	PS
Cutting conditions	B014

Application	Medium cutting
Grade	AH6225
Chipbreaker shape	PS
Cutting conditions	B016

Application	Finishing to medium cutting	Application	Finishing	Finishing to medium cutting
	Grade		Grade	Grade
Breaker Shape	T515	PS	AH8005	AH8015
Cutting conditions	B020	PS	PS	PS
Cutting conditions	B024			

Application	Precision finishing	Finishing
	Grade	Grade
Breaker Shape	BXA10	BXA20
Cutting conditions	B026	

Reference pages: A-SVJBR/L: Insert → B150 -, CBN → B207 -

STREAMJETBAR

A-SVJCR/L

Screw-on boring bar, for positive 35° rhombic inserts

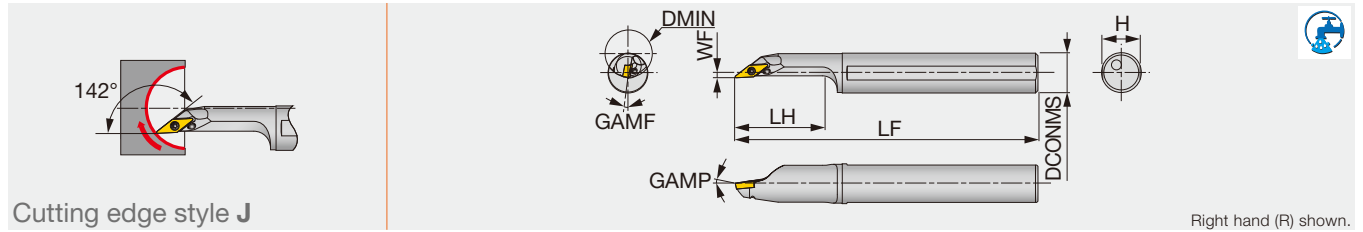

Cutting edge style J

Right hand (R) shown.

Designation	Material	DMIN	DCONMS	WF	LF	LH	H	GAMP	GAMF	RE**	Insert	Torque*
A12M-SVJCR/L08-D160	Steel	16	12	2	150	28	11	-5°	-5°	0.4	VC**0802...	0.6
A16Q-SVJCR/L08-D200	Steel	20	16	2	180	35	15	-5°	-5°	0.4	VC**0802...	0.6

*Torque: Recommended clamping torque (N-m)

**RE : Standard corner radius

Note: Use right-hand toolholders (SVJCR**) with left-hand inserts (L); and left-hand toolholders (SVJCL**) with right-hand inserts (R).

SPARE PARTS

Designation	Clamping screw	Wrench
A**-SVJC*08-D...	CSTB-2L	T-6F

INSERT SELECTION

P

Application	Finishing	Finishing to medium cutting
Grade	NS9530	T9215
Breaker Shape	PSS	PS
Images		
Cutting conditions	B014	

M

Application	Finishing	Finishing to medium cutting
Grade	AH6225	AH6225
Breaker Shape	PSS	PS
Images		
Cutting conditions	B016	

K

Application	Finishing to medium cutting
Grade	T515
Breaker Shape	CM
Image	
Cutting conditions	B020

N

Application	Precision finishing	Finishing	Medium cutting
Grade	DX120	DX140	KS05F
Breaker Shape	DIA	with rake DIA	AL
Images			
Cutting conditions	B022		

S

Application	Finishing	Finishing to medium cutting
Grade	AH8005	AH8015
Breaker Shape	PS	PS
Images		
Cutting conditions	B024	

H

Application	Precision finishing	Finishing
Grade	BXA10	BXA20
Breaker Shape	CBN	CBN
Images		
Cutting conditions	B026	

Reference pages: A-SVJCR/L: Insert → B152 -

Grade
Insert
Ext. Toolholder
Int. Toolholder
Threading
Grooving
Miniature tool
Milling cutter
Endmill
Drilling tool
Tooling System
User's Guide
Index



Screw-on boring bar for roughing, for negative tangential inserts

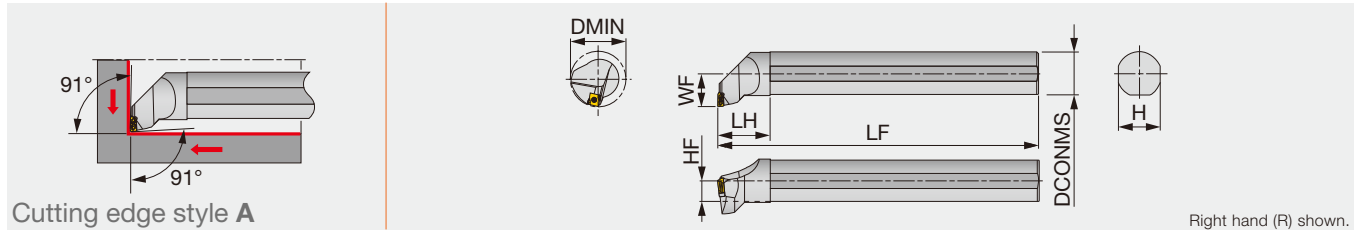

Designation	Material	DMIN	DCONMS	WF	LF	LH	H	HF	Insert
S25T-TLANR/L12-D530	Steel	53	25	17	300	40	23	11.5	LNMX1204**L/R...
S32U-TLANR/L12-D530	Steel	53	32	22	350	45	30	15	LNMX1204**L/R...
S40V-TLANR/L12-D530	Steel	53	40	27	400	53	37	18.5	LNMX1204**L/R...
S50U-TLANR/L16-D850	Steel	85	50	37	350	63	47	23.5	LNMX1606**L/R...

Note: Use right-hand toolholders (TLANR**) with left-hand inserts (L); and left-hand toolholders (TLANL**) with right-hand inserts (R).

SPARE PARTS

Designation	Clamping screw	Shim screw	Shim	Spring pin	Wrench 1	Wrench 2
S**-TLANR/L12-D530	CSTB-3.5L115-S	CSTF-2L055-S	TSL12L/RI	-	KEYV-T10	T-6F-S
S50U-TLANR16-D850	CSTB-4L115-S	-	TSL16LI	PSP-16	KEYV-T15	-
S50U-TLANL16-D850	CSTB-4L115-S	-	TSL16RI	PSP-16	KEYV-T15	-

INSERT

LNMX12/16/24

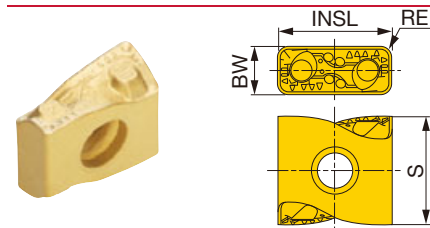

	P	M	K	N	S	H
Steel	★	★	★			
Stainless	☆		☆			
Cast iron	☆	☆	☆			
Non-ferrous						
Superalloys						
Hard materials						

★ : First choice
☆ : Second choice

Designation	HAND	RE	Coated			BW	INSL	S
			T9115	T9125	AH725			
LNMX120408R-TDR	R	0.8	●	●		4.8	12	11.6
LNMX120408L-TDR	L	0.8	●	●		4.8	12	11.6
LNMX120412R-TDR	R	1.2	●	●		4.8	12	11.6
LNMX120412L-TDR	L	1.2	●	●		4.8	12	11.6
LNMX160608R-TDR	R	0.8	●	●		6.4	16.2	13.5
LNMX160608L-TDR	L	0.8	●	●		6.4	16.2	13.5
LNMX160612R-TDR	R	1.2	●	●		6.4	16.2	13.5
LNMX160612L-TDR	L	1.2	●	●		6.4	16.2	13.5
LNMX160616R-TDR	R	1.6	●	●		6.4	16.2	13.5
LNMX160616L-TDR	L	1.6	●	●		6.4	16.2	13.5
LNMX241016R-TDR	R	1.6	●	●		9.4	24	20.5
LNMX241016L-TDR	L	1.6	●	●		9.4	24	20.5
LNMX241024R-TDR	R	2.4	●	●		9.4	24	20.5
LNMX241024L-TDR	L	2.4	●	●		9.4	24	20.5
LNMX160608R-MDR	R	0.8	●	●	●	6.4	16.2	13.5
LNMX160608L-MDR	L	0.8	●	●	●	6.4	16.2	13.5
LNMX160612R-MDR	R	1.2	●	●	●	6.4	16.2	13.5
LNMX160612L-MDR	L	1.2	●	●	●	6.4	16.2	13.5
LNMX160608R-TWR	R	0.8	●	●		6.4	16.2	13.5
LNMX160608L-TWR	L	0.8	●	●		6.4	16.2	13.5
LNMX160612R-TWR	R	1.2	●	●		6.4	16.2	13.5
LNMX160612L-TWR	L	1.2	●	●		6.4	16.2	13.5

Reference pages: Standard cutting conditions → **D097**

●: Line up

STREAMJETBAR

A-SSKPR

Screw-on boring bar, for positive square inserts

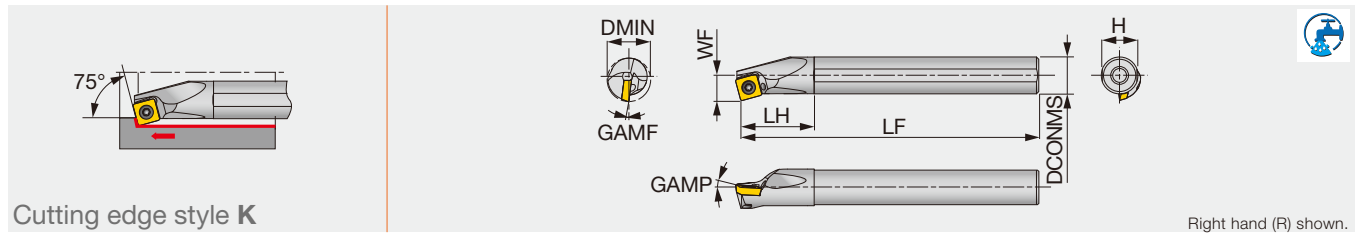

Cutting edge style K

Right hand (R) shown.

Designation	Material	DMIN	DCONMS	WF	LF	LH	H	GAMP	GAMF	RE**	Insert	Torque*
A16Q-SSKPR09-D200	Steel	20	16	11	180	32	15	5°	-6°	0.8	SP**0903...	3
A20R-SSKPR09-D240	Steel	24	20	13	200	36	18	5°	-2°	0.8	SP**0903...	3
A25S-SSKPR12-D310	Steel	31	25	17	250	45	23	5°	-2°	0.8	SP**1204...	6

*Torque: Recommended clamping torque (N-m)



**RE : Standard corner radius

Note: Use right-hand toolholders (SSKPR**) with left-hand inserts (L); and left-hand toolholders (SSKPL**) with right-hand inserts (R).

SPARE PARTS

Designation	Clamping screw	Wrench
A**-SSKPR09-D2*0	CSTB-4L060	T-15F
A25S-SSKPR12-D310	CSTB-5S	T-20F

INSERT SELECTION

P	Application	Finishing to medium cutting	M	Application	Finishing to medium cutting
	Grade	T9215		Grade	AH6225
	Breaker Shape	PS 		Breaker Shape	PS 
Cutting conditions		B016	Cutting conditions		B018
K	Application	Finishing to medium cutting			
	Grade	T515			
	Breaker Shape	CM 			
Cutting conditions		B020			

Reference pages: A-SSKPR: Insert → B135 -, CBN → B195 -



S/C-CSKPR/L

Clamp-on boring bar, for positive square inserts

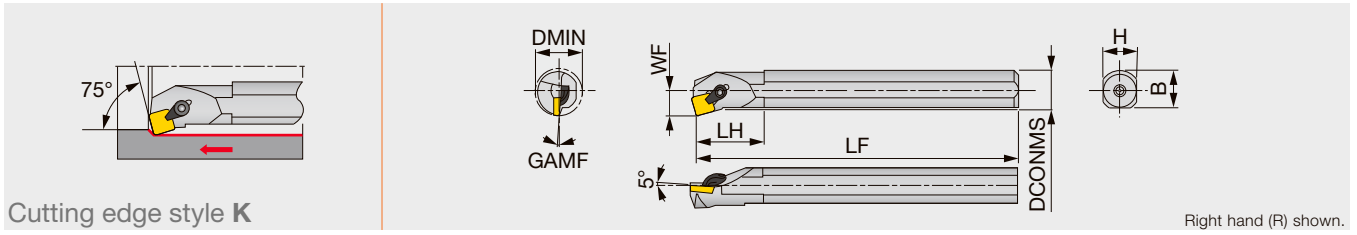

Cutting edge style K

Right hand (R) shown.

Designation	Material	DMIN	DCONMS	WF	LF	LH	H	B	GAMF	RE**	Insert
S16Q-CSKPR09	Steel	20	16	11	180	30	15	15	-4°	0.8	SP**0903...
S20R-CSKPR/L09	Steel	25	20	13	200	40	18	18.5	-2°	0.8	SP**0903...
S25S-CSKPR12	Steel	32	25	17	250	45	23	22.5	0°	0.8	SP**1203...

**RE : Standard corner radius

Note: Use right-hand toolholders (R) with left-hand inserts (L); and left-hand toolholders (L) with right-hand inserts (R).

SPARE PARTS

Designation	Clamp set	Wrench
S16Q-CSKPR09	CSG-5S	P-2.5
S20R-CSKPR/L09	CSG-5	P-2.5
S25S-CSKPR12	CSG-6	P-3

Reference pages: S/C-CSKPR/L: Insert → **B135 -**, CBN → **B195 -**, PCD → **B215**

STREAMJETBAR

A-PSKNR/L

Lever-lock boring bar, for negative square inserts

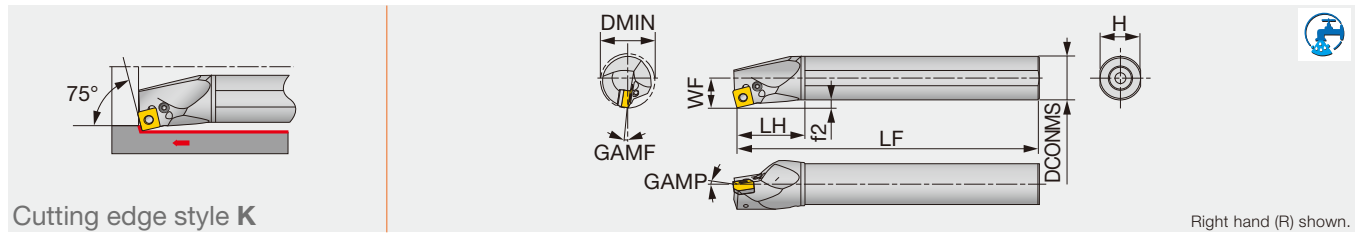

Designation	Material	DMIN	DCONMS	WF	LF	LH	H	f2	GAMP	GAMF	RE**	Insert	Torque*
A32S-PSKNR/L12-D400	Steel	40	32	22	250	50	30	6	-6°	-10°	0.8	SN**1204...	4.8
A40T-PSKNR/L12-D500	Steel	50	40	27	300	60	37	7	-6°	-10°	0.8	SN**1204...	4.8
A50U-PSKNR/L12-D630	Steel	63	50	35	350	65	47	10	-6°	-8°	0.8	SN**1204...	4.8

*Torque: Recommended clamping torque (N-m)

**RE : Standard corner radius

Note: Use right-hand toolholders (PSKNR**) with left-hand inserts (L); and left-hand toolholders (PSKNL**) with right-hand inserts (R).

SPARE PARTS

Designation	Shim	Screw	Wrench	Spring pin	Lever	Oil supply attachment*	Screw for oil hole*
A32S-PSKNR/L12-D400	LSS42BR/L	LCS4	P-3	LSP4	LCL4	EA-32	SSHM4-5
A40T-PSKNR/L12-D500	LSS42BR/L	LCS4	P-3	LSP4	LCL4	-	SSHM6-6
A50U-PSKNR/L12-D630	LSS42BR/L	LCS4	P-3	LSP4	LCL4	-	SSHM6-6

*Optional

S-PSKNR

Lever-lock boring bar, for negative square inserts

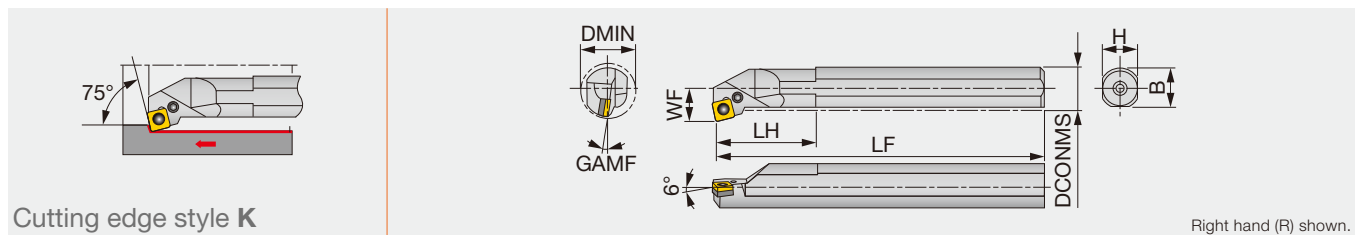

Designation	Material	DMIN	DCONMS	WF	LF	LH	H	B	GAMF	RE**	Insert
S32S-PSKNR12	Steel	40	32	22	250	50	30	29.5	-10°	0.8	SN**1204...
S40T-PSKNR12	Steel	50	40	27	300	55	37	37.5	-10°	0.8	SN**1204...
S50U-PSKNR12	Steel	63	50	35	350	65	47	47.5	-8°	0.8	SN**1204...

**RE : Standard corner radius

Note: Use right-hand toolholders (R) with left-hand inserts (L); and left-hand toolholders (L) with right-hand inserts (R).

SPARE PARTS

Designation	Shim	Clamping screw	Wrench	Spring pin	Lever
S**-PSKNR12	LSS42BR	LCS4	P-3	LSP4	LCL4

Reference pages: A-PSKNR/L, S-PSKNR: Insert → **B077** -, CBN → **B180**, PCD → **B211**



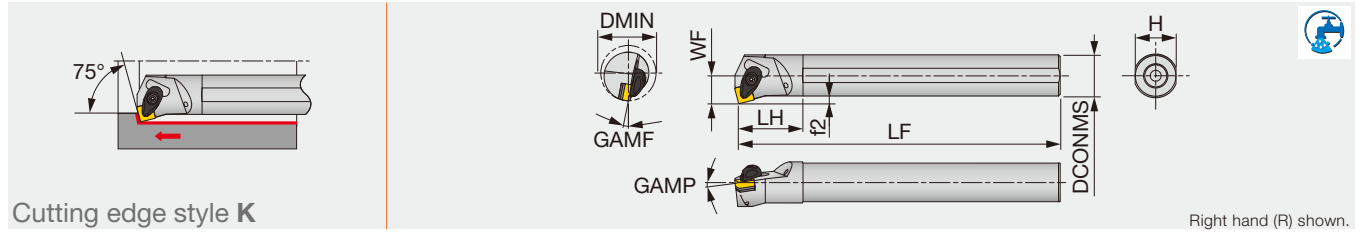

Designation	Material	DMIN	DCONMS	WF	LF	LH	H	f2	GAMP	GAMF	RE**	Insert	Torque*
A25R-ASKNR/L12-D320	Steel	32	25	17	200	45	23	4.5	-6°	-13°	0.8	SN**1204...	3
A32S-ASKNR/L12-D400	Steel	40	32	22	250	50	30	6	-6°	-10°	0.8	SN**1204...	3

*Torque: Recommended clamping torque (N-m)

**RE : Standard corner radius

SPARE PARTS

Designation	Clamp	Clamp screw	Spring	Spring pin	Shim	Shim screw	Wrench
A**-ASKN*12-D...	ACP4S	ACS-5W	BP-7	SP-2.5	ASS422	CSTB-3.5	T-15F

INSERT SELECTION

Application	Precision finishing	Finishing	Medium cutting	Medium to heavy cutting
	Grade	NS9530	GT9530	T9215
Breaker Shape	TF	TSF	TM	TH
Cutting conditions	B004			

Application	Finishing	Medium cutting	Medium to heavy cutting
	Grade	T6215	AH6225
Chipbreaker Shape	SF	SM	SH
Cutting conditions	B006		

Application	Finishing	Medium cutting	Medium to heavy cutting
	Grade	T515	T515
Breaker Shape	All-round	All-round	All-round
Cutting conditions	B008		

Application	Finishing	Medium cutting
	Grade	DX140
Breaker Shape	T-DIA	P
Cutting conditions	B010	

Application	Precision finishing	Finishing	Medium cutting
	Grade	BX480	AH8005
Breaker Shape	T-CBN	HRF	HRM
Cutting conditions	B012		

Reference pages: A-ASKNR/L: Insert → **B077 -**, CBN → **B180**, PCD → **B211**

STREAMJETBAR

A/E-STFCR/L

Screw-on boring bar, for positive 60° triangular inserts

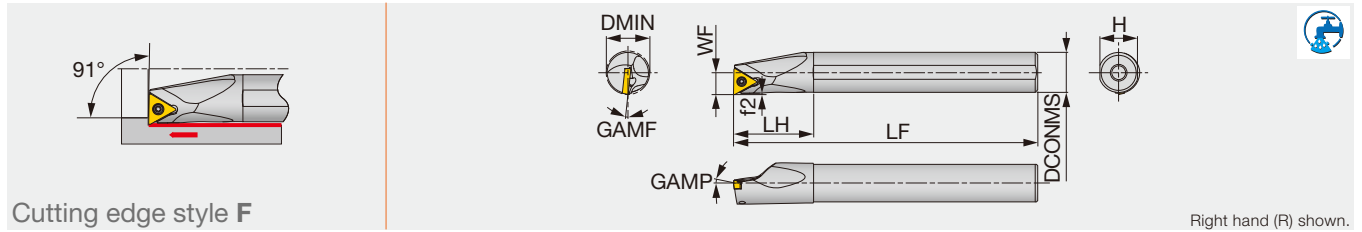

Cutting edge style F

Right hand (R) shown.

Designation	Material	DMIN	DCONMS	WF	LF	LH	H	f2	GAMP	GAMF	RE**	Insert	Torque*
A10K-STFCR/L1103-D120	Steel	12	10	6.5	125	20	9	0.6	0°	-13°	0.4	TC**1103...	1.2
A12M-STFCR/L1103-D140	Steel	14	12	7	150	24	11	0.5	0°	-10°	0.4	TC**1103...	1.2
A16Q-STFCR/L1103-D180	Steel	18	16	9	180	32	15	0.5	0°	-7°	0.4	TC**1103...	1.2
E10M-STFCR/L1103-D120	Carbide	12	10	6.5	150	25	9	0.7	0°	-13°	0.4	TC**1103...	1.2
E12Q-STFCR/L1103-D140	Carbide	14	12	7	180	27	11	0.5	0°	-10°	0.4	TC**1103...	1.2
E16R-STFCR/L1103-D180	Carbide	18	16	9	200	32	15	0.5	0°	-7°	0.4	TC**1103...	1.2

*Torque: Recommended clamping torque (N-m)

**RE : Standard corner radius

Note: Use right-hand toolholders (STFCR**) with left-hand inserts (L); and left-hand toolholders (STFCL**) with right-hand inserts (R).

SPARE PARTS

Designation	Clamping screw	Wrench
A**-STFCR/L1103-D...	CSTB-2.5	T-8F
E**-STFCR/L1103-D...	CSTB-2.5	T-8F

INSERT SELECTION

P	Application	Precision finishing	Finishing	Finishing to medium cutting	Medium cutting
	Grade	SH725	SH725	T9215	T9215
	Breaker Shape	JP	JS	PS	PM
	Cutting conditions	B016			
M	Application	Precision finishing	Finishing	Finishing to medium cutting	Medium cutting
	Grade	SH725	SH725	AH6225	AH6225
	Breaker Shape	JP	JS	PS	PM
	Cutting conditions	B018			
K	Application	Finishing to medium cutting			
	Grade	T515			
	Breaker Shape	CM			
Cutting conditions	B020				
N	Application	Precision finishing	Finishing to medium cutting		
	Grade	DX120	KS05F		
	Breaker Shape	DIA	with rake AL		
	Cutting conditions	B022			
S	Application	Precision finishing	Finishing	Finishing to medium cutting	Medium cutting
	Grade	SH725	SH725	AH6225	AH6225
	Breaker Shape	JP	JS	PS	PM
	Cutting conditions	B024			

Reference pages: A/E-STFCR/L: Insert → B138 -, PCD → B216



STREAMJETBAR

A/E-STFPR/L

Screw-on boring bar, for positive 60° triangular inserts

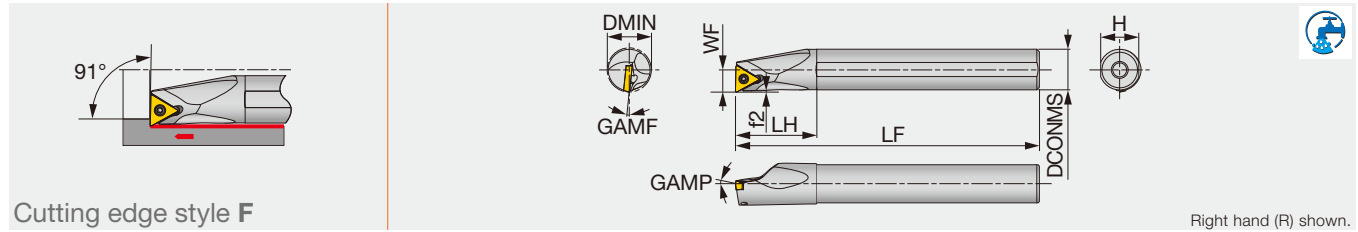

Designation	Material	DMIN	DCONMS	WF	LF	LH	H	f2	GAMP	GAMF	RE**	Insert	Torque*
A08H-STFPR/L09-D100	Steel	10	8	5.5	100	16	7.5	0.7	5°	-8°	0.4	TP**0902...	0.9
A10K-STFPR/L1102-D120	Steel	12	10	6.5	125	20	9	0.7	5°	-6°	0.4	TP**1102...	1.2
A12M-STFPR/L1102-D140	Steel	14	12	7.0	150	24	11	0.6	5°	-4°	0.4	TP**1102...	1.2
A16Q-STFPR/L13-D180	Steel	18	16	9	180	32	15	0.7	5°	-2°	0.4	TP**1303...	1.4
A20R-STFPR13-D220	Steel	22	20	11	200	36	18	0.8	5°	-2°	0.4	TP**1303...	1.4
A25S-STFPR16-D270	Steel	27	25	13.5	250	45	23	0.6	5°	-1°	0.4	TP**16T3...	3
E08K-STFPR/L09-D100	Carbide	10	8	5.5	125	22	7.5	0.7	5°	-8°	0.4	TP**0902...	0.9
E10M-STFPR/L1102-D120	Carbide	12	10	6.5	150	25	9	0.7	5°	-6°	0.4	TP**1102...	1.2
E12Q-STFPR/L1102-D140	Carbide	14	12	7	180	27	11	0.6	5°	-4°	0.4	TP**1102...	1.2
E16R-STFPR13-D180	Carbide	18	16	9	200	32	15	0.7	5°	-2°	0.4	TP**1303...	1.4
E20S-STFPR13-D220	Carbide	22	20	11	250	36	18	0.8	5°	-2°	0.4	TP**1303...	1.4

*Torque: Recommended clamping torque (N-m)

**RE : Standard corner radius

Note: Use right-hand toolholders (STFPR**) with left-hand inserts (L); and left-hand toolholders (STFPL**) with right-hand inserts (R).

(1) TPGH, TPGM, and TPGA inserts cannot be used.

Designation	Clamping screw	Wrench
A08H-STFPR/L09-D100	CSTB-2.2S	T-7F
A10K-STFPR/L1102-D120	CSTB-2.5B	T-8F
A12M-STFPR/L1102-D140	CSTB-2.5	T-8F
A16Q-STFPR/L13-D180	CSTB-3S	T-9F
A20R-STFPR13-D220	CSTB-3	T-9F
A25S-STFPR16-D270	CSTB-4M	T-15F
E08K-STFPR/L09-D100	CSTB-2.2S	T-7F
E10M-STFPR/L1102-D120	CSTB-2.5B	T-8F
E12Q-STFPR/L1102-D140	CSTB-2.5	T-8F
E16R-STFPR13-D180	CSTB-3S	T-9F
E20S-STFPR13-D220	CSTB-3	T-9F

INSERT SELECTION

Application	Finishing	Finishing to medium cutting	Medium cutting
Grade	NS9530	T9215	T9215
Breaker Shape	PSS	PS	PM
Cutting conditions	B016		

Application	Finishing	Finishing to medium cutting	Medium cutting
Grade	AH6225	AH6225	AH6225
Breaker Shape	PSS	PS	PM
Cutting conditions	B018		

Application	Finishing to medium cutting
Grade	T515
Breaker Shape	CM
Cutting conditions	B020

Application	Precision finishing
Grade	DX140
Breaker Shape	DIA with rake
Cutting conditions	B022

Application	Precision finishing
Grade	BX470
Breaker Shape	CBN
Cutting conditions	B024

Application	Precision finishing	Finishing
Grade	BXA10	BXA20
Breaker Shape	HP	HS
Cutting conditions	B026	

Reference pages: A/E-STFPR/L: Insert → B142 -, CBN → B199 -, PCD → B216 -

S/C-CTFPR/L

Clamp-on boring bar, for positive 60° triangular inserts

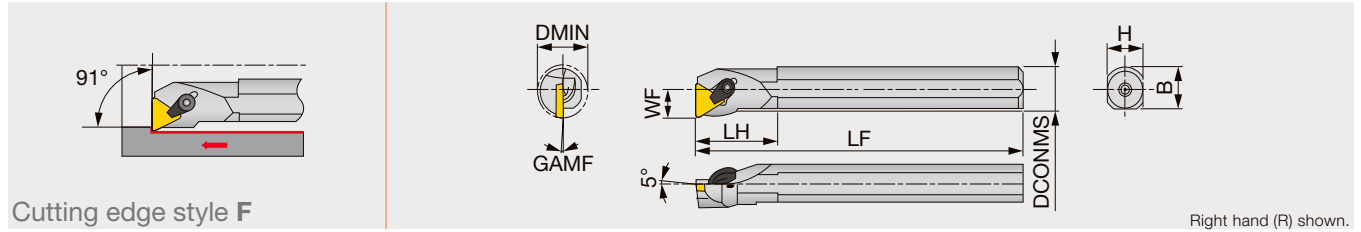

Designation	Material	DMIN	DCONMS	WF	LF	LH	H	B	GAMF	RE**	Insert
S12M-CTFPR/L11	Steel	16	12	9	150	25	11	11.5	-6°	0.4	TP**1103...
S16Q-CTFPR/L11	Steel	20	16	11	180	30	15	15	-4°	0.4	TP**1103...
S20R-CTFPR/L16	Steel	25	20	13	200	40	18	18.5	-2°	0.8	TP**1603...
S25S-CTFPR/L16	Steel	32	25	17	250	45	23	22.5	0°	0.8	TP**1603...
S32T-CTFPR/L16	Steel	40	32	22	300	50	30	29.5	0°	0.8	TP**1603...
C12Q-CTFPR/L11	Carbide	16	12	9	180	-	11	-	-6°	0.4	TP**1103...
C16R-CTFPR/L11	Carbide	20	16	11	200	-	15	-	-4°	0.4	TP**1103...

**RE : Standard corner radius

Note: Use right-hand toolholders (R) with left-hand inserts (L); and left-hand toolholders (L) with right-hand inserts (R).

SPARE PARTS

Designation	Clamp set 1	Clamp set 2	Wrench	Shim	Shim screw
S12M-CTFPR/L11	CSW-00	-	P-2.5	-	-
S16Q-CTFPR/L11	-	CSG-5S	P-2.5	-	-
S20R-CTFPR/L16	-	CSG-6S	P-3	-	-
S25S-CTFPR/L16	-	CSG-6	P-3	-	-
S32T-CTFPR/L16	-	CSG-6	P-3	PAT-32	M3X0.5X6
C12Q-CTFPR/L11	CSW-00	-	P-2.5	-	-
C16R-CTFPR/L11	-	CSG-5S	P-2.5	-	-

Reference pages: S/C-CTFPR/L: Insert → **B142 -**, CBN → **B199 -**, PCD → **B217 -**

Screw-on clamp exchangeable boring head, for positive 60° triangular inserts

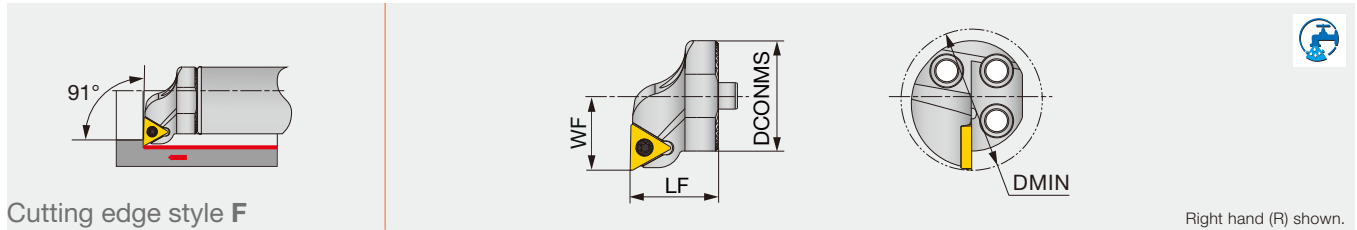

Cutting edge style F

Right hand (R) shown.

Designation	DMIN	DCONMS	WF	LF	Shank	Insert
S16-STFPR/L09-H	20	16	11	20	D16	TP**0902...
S16-STFPR/L11-H	20	16	11	20	D16	TP**1102...
S20-STFPR/L11-H	25	20	13	20	D20	TP**1102...
S25-STFPR/L11-H	32	25	17	20	D25	TP**1102...
S32-STFPR/L16-H	40	32	22	32	D32	TP**16T3...
S40-STFPR/L16-H	50	40	27	32	D40, D50, D60	TP**16T3...

Note: Use right-hand toolholders (STFPR**) with left-hand inserts (L); and left-hand toolholders (STFPL**) with right-hand inserts (R).

SPARE PARTS

Designation	Clamping screw	Wrench
S16-STFPR/L09-H	CSTB-2.2S	T-7F
S16-STFPR/L11-H	CSTB-2.5	T-8F
S20-STFPR/L11-H	CSTB-2.5	T-8F
S25-STFPR/L11-H	CSTB-2.5	T-8F
S32-STFPR/L16-H	CSTB-4M	T-15F
S40-STFPR/L16-H	CSTB-4M	T-15F

INSERT SELECTION

Application	Finishing	Finishing to medium cutting	Medium cutting
	Grade	NS9530	T9215
Breaker Shape	PSS	PS	PM
Cutting conditions	B016		

Application	Finishing	Finishing to medium cutting	Medium cutting
	Grade	AH6225	AH6225
Breaker Shape	PSS	PS	PM
Cutting conditions	B018		

Application	Finishing to medium cutting
Grade	T515
Breaker Shape	CM
Cutting conditions	B020

Application	Precision finishing
Grade	DX140
Breaker Shape	DIA with rake
Cutting conditions	B022

Application	Precision finishing
Grade	BX470
Breaker Shape	CBN
Cutting conditions	B024

Application	Precision finishing	Finishing
Grade	BXA10	BXA20
Breaker Shape	HP	HS
Cutting conditions	B026	

Reference pages: S-STFPR/L-H: Insert → B142 -, CBN → B199 -, PCD → B216 -
Shank → D090 - D092

STREAMJETBAR

A-PTFNR/L

Lever-lock boring bar, for negative triangular inserts

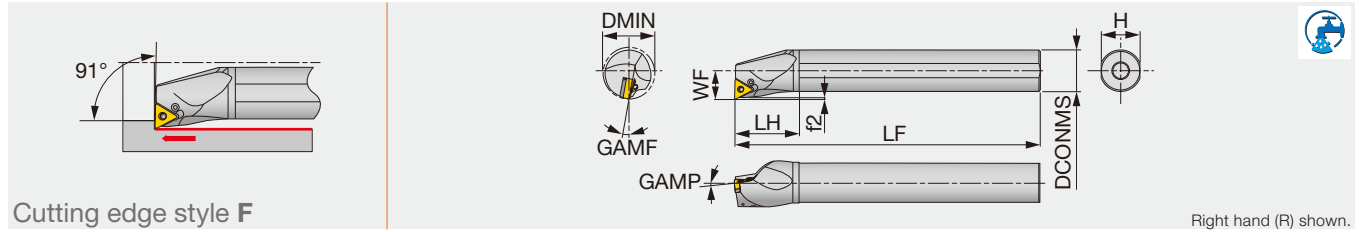

Designation	Material	DMIN	DCONMS	WF	LF	LH	H	f2	GAMP	GAMF	RE**	Insert	Torque*
A25R-PTFNR/L1104-D320	Steel	32	25	17	200	45	23	1.31	-6°	-12°	0.8	TN**1104...	2
A32S-PTFNR/L1104-D400	Steel	40	32	22	250	50	30	1.25	-6°	-10°	0.8	TN**1104...	2
A25R-PTFNR/L16-D320	Steel	32	25	17	200	45	23	1.2	-6°	-12°	0.8	TN**1604...	2.7
A32S-PTFNR/L16-D400	Steel	40	32	22	250	50	30	1.1	-6°	-10°	0.8	TN**1604...	2.7
A40T-PTFNR/L16-D500	Steel	50	40	27	300	60	37	1.1	-6°	-10°	0.8	TN**1604...	2.7
A50U-PTFNR/L16-D630	Steel	63	50	35	350	65	47	1.1	-6°	-8°	0.8	TN**1604...	2.7

*Torque: Recommended clamping torque (N-m)

**RE : Standard corner radius

Note: Use right-hand toolholders (PTFNR**) with left-hand inserts (L); and left-hand toolholders (PTFNL**) with right-hand inserts (R).

SPARE PARTS

Designation	Shim	Clamping screw 1	Clamping screw 2	Wrench	Spring pin	Lever	Oil supply attachment*	Screw for oil hole*
A25R-PTFNR/L1104-D320	-	LCS23A	-	P-2.5	-	LCL23	EA-25	SSH4-5
A32S-PTFNR/L1104-D400	-	LCS23A	-	P-2.5	-	LCL23	EA-32	SSH4-5
A25R-PTFNR/L16-D320	ELST317BR/L	-	LCS3	P-2.5	LSP3	LCL33	EA-25	SSH4-5
A32S-PTFNR/L16-D400	LST317BR/L	-	LCS3	P-2.5	LSP3	LCL3	EA-32	SSH4-5
A40T-PTFNR/L16-D500	LST317BR/L	-	LCS3	P-2.5	LSP3	LCL3	-	SSH6-6
A50U-PTFNR/L16-D630	LST317BR/L	-	LCS3	P-2.5	LSP3	LCL3	-	SSH6-6

*Optional

S-PTFNR/L

Lever-lock boring bar, for negative 60° triangular inserts

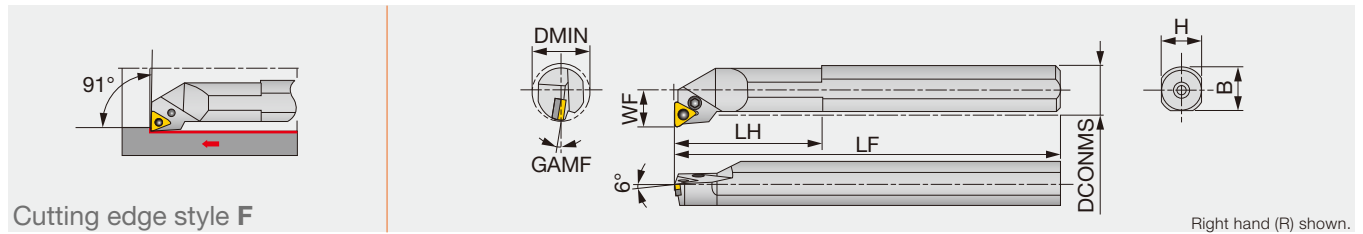

Designation	Material	DMIN	DCONMS	WF	LF	LH	H	B	GAMP	RE**	Insert	Torque*
S32S-PTFNR/L16	Steel	40	32	22	250	50	30	29.5	-10°	0.8	TN**1604...	2.7
S40T-PTFNR/L16	Steel	50	40	27	300	55	37	37.5	-10°	0.8	TN**1604...	2.7
S50U-PTFNR16	Steel	63	50	35	350	65	47	47.5	-8°	0.8	TN**1604...	2.7

*Torque: Recommended clamping torque (N-m)

**RE : Standard corner radius

Note: Use right-hand toolholders (R) with left-hand inserts (L); and left-hand toolholders (L) with right-hand inserts (R).

SPARE PARTS

Designation	Shim	Clamping screw	Wrench	Spring pin	Lever
S32S-PTFNR16	LST317BR	LCS3	P-2.5	LSP3	LCL3
S32S-PTFNL16	LST317BL	LCS3	P-2.5	LSP3	LCL3
S40T-PTFNR16	LST317BR	LCS3	P-2.5	LSP3	LCL3
S40T-PTFNL16	LST317BL	LCS3	P-2.5	LSP3	LCL3
S50U-PTFNR16	LST317BR	LCS3	P-2.5	LSP3	LCL3

Reference pages: A-PTFNR/L, S-PTFNR/L: Insert → B087 -, CBN → B182 -, PCD → B212

Lever-lock clamp exchangeable boring head, for negative 60° triangular inserts

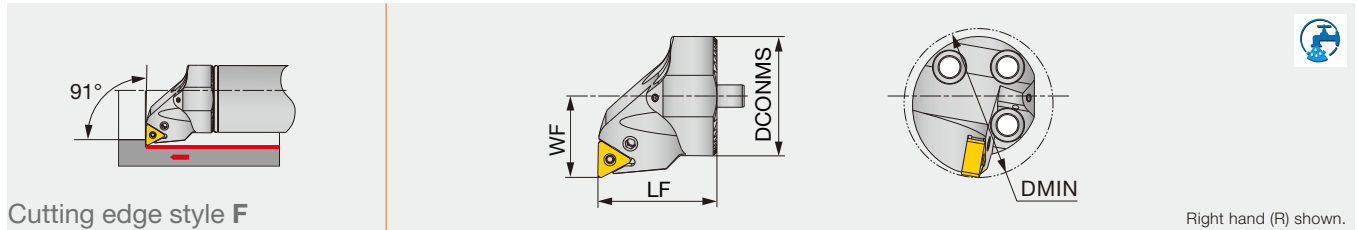

Cutting edge style F

Right hand (R) shown.

Designation	DMIN	DCONMS	WF	LF	Shank	Insert
S32-PTFNR/L11-H	40	32	22	32	D32	TN**1104...
S40-PTFNR/L11-H	50	40	27	32	D40, D50, D60	TN**1104...

Note: Use right-hand toolholders (PTFNR**) with left-hand inserts (L); and left-hand toolholders (PTFNL**) with right-hand inserts (R).

SPARE PARTS

Designation	Lever	Clamping screw	Wrench
S**-PTFNR/L11-H	LCL23	LCS23A	P-2.5

INSERT SELECTION

Application	Precision finishing	Finishing	Medium cutting	Medium to heavy cutting
	Grade	NS9530	GT9530	T9215
Breaker Shape	TF	TSF	TM	TH
Images				
Cutting conditions	B004			

Application	Finishing	Medium cutting
	Grade	T6215
Breaker Shape	SF	SM
Images		
Cutting conditions	B006	

Application	Finishing	Medium cutting	Medium to heavy cutting
	Grade	T515	T515
Breaker Shape	All-round	All-round	All-round
Images			
Cutting conditions	B008		

Application	Precision finishing	Finishing	Medium cutting
	Grade	DX120	DX140
Breaker Shape	DIA	with rake DIA	P
Images			
Cutting conditions	B010		

Application	Precision finishing	Finishing	Medium cutting
	Grade	BX470	AH8005
Breaker Shape	T-CBN	HRF	HRM
Images			
Cutting conditions	B012		

Application	Precision finishing	Finishing
	Grade	BXA10
Breaker Shape	HP	HS
Images		
Cutting conditions	B014	

Reference pages: S-PTFNR/L-H: Insert → **B087 -**, CBN → **B184**
Shank → **D090 - D092**

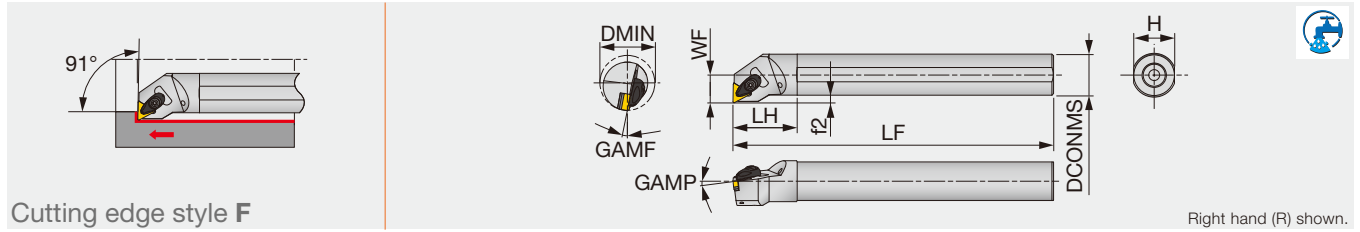

Cutting edge style F

Right hand (R) shown.

Designation	Material	DMIN	DCONMS	WF	LF	LH	H	f2	GAMP	GAMF	RE**	Insert	Torque*
A25R-ATFNR/L16-D320	Steel	32	25	17	200	45	23	4.5	-6°	-13°	0.8	TN**1604...	3
A32S-ATFNR/L16-D400	Steel	40	32	22	250	50	30	6	-6°	-10°	0.8	TN**1604...	3

*Torque: Recommended clamping torque (N-m)

**RE : Standard corner radius

SPARE PARTS

Designation	Clamp	Clamp screw	Spring	Spring pin	Shim	Shim screw	Wrench
A**-ATFNR/L16-D...	ACP3S	ACS-5W	BP-7	SP-2.5	AST322	CSTB-3.5	T-15F

INSERT SELECTION

Application	Precision finishing	Finishing	Medium cutting	Medium to heavy cutting
	Grade	NS9530	GT9530	T9215
Breaker Shape	TF	TSF	TM	TH
Cutting conditions	B004			

Application	Finishing	Medium cutting
	Grade	T6215
Breaker Shape	SF	SM
Cutting conditions	B006	

Application	Finishing	Medium cutting	Medium to heavy cutting
	Grade	T515	T515
Breaker Shape	All-round	All-round	All-round
Cutting conditions	B008		

Application	Precision finishing	Finishing	Medium cutting
	Grade	DX120	DX140
Breaker Shape	DIA	with rake DIA	P
Cutting conditions	B010		

Application	Precision finishing	Finishing	Medium cutting
	Grade	BX470	AH8005
Breaker Shape	CBN	HRF	HRM
Cutting conditions	B012		

Application	Precision finishing	Finishing
	Grade	BXA10
Breaker Shape	HP	HS
Cutting conditions	B014	

Reference pages: A-ATFNR/L: Insert → **B087 -**, CBN → **B182 -**, PCD → **B212**



STREAMJETBAR

A/E-SWUBR/L

Screw-on boring bar, for positive 80° trigon inserts

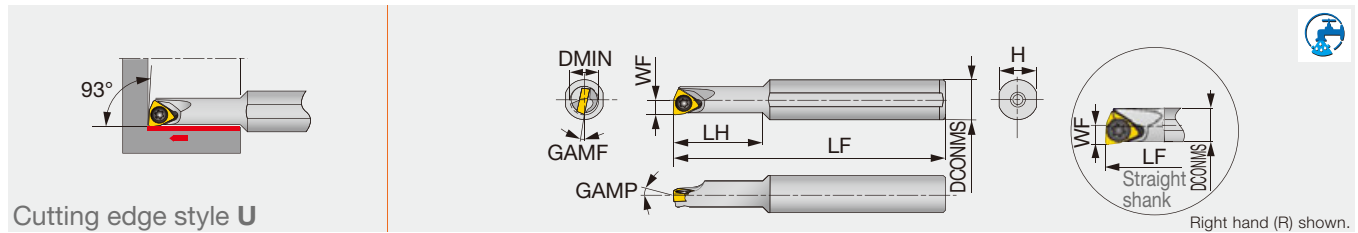

Cutting edge style U

Right hand (R) shown.

Designation	Material	DMIN	DCONMS	WF	LF	LH	H	GAMP	GAMF	RE**	Insert	Torque*
A05F-SWUBR/L03-D060	Steel	6	5	3	80	9	4.8	0°	-13°	0.4	WB**0301...	0.6
A06G-SWUBR/L03-D070	Steel	7	6	3.5	90	11	5.75	0°	-12°	0.4	WB**0301...	0.6
A07G-SWUBR/L03-D080	Steel	8	7	4	90	12	6.75	0°	-11°	0.4	WB**0301...	0.6
A08H-SWUBR03-D060	Steel	6	8	3.1	100	18	7.5	0°	-12°	0.4	WB**0301...	0.6
A08H-SWUBR03-D070	Steel	7	8	3.6	100	20	7.5	0°	-12°	0.4	WB**0301...	0.6
E05G-SWUBR/L03-D060	Carbide	6	5	3	90	10	4.8	0°	-13°	0.4	WB**0301...	0.6
E06H-SWUBR/L03-D070	Carbide	7	6	3.5	100	12	5.75	0°	-12°	0.4	WB**0301...	0.6
E07H-SWUBR/L03-D080	Carbide	8	7	4	100	14	6.75	0°	-11°	0.4	WB**0301...	0.6
E08K-SWUBR03-D060	Carbide	6	8	3.1	125	30	7.5	0°	-12°	0.4	WB**0301...	0.6
E08K-SWUBR03-D070	Carbide	7	8	3.6	125	40	7.5	0°	-12°	0.4	WB**0301...	0.6

*Torque: Recommended clamping torque (N-m)

**RE : Standard corner radius

Note: Use right-hand toolholders (SVUCR*) with left-hand inserts (L); and left-hand toolholders (SWUBL**) with right-hand inserts (R).

SPARE PARTS

Designation	Clamping screw	Wrench
A/E**-SWUBR/L...	CSTB-2	T-6F

INSERT SELECTION

Application	Finishing	Application	Finishing	Application	Finishing	Application	Finishing
Grade	SH725	Grade	SH725	Grade	SH725	Grade	SH725
Breaker Shape		Breaker Shape		Breaker Shape		Breaker Shape	
Cutting conditions	B016	Cutting conditions	B018	Cutting conditions	B020	Cutting conditions	B022

Reference pages: A/E-SWUBR/L: Insert → **B156** -

STREAMJETBAR

A/E-STUPR/L

Screw-on boring bar, for positive 60° triangular inserts

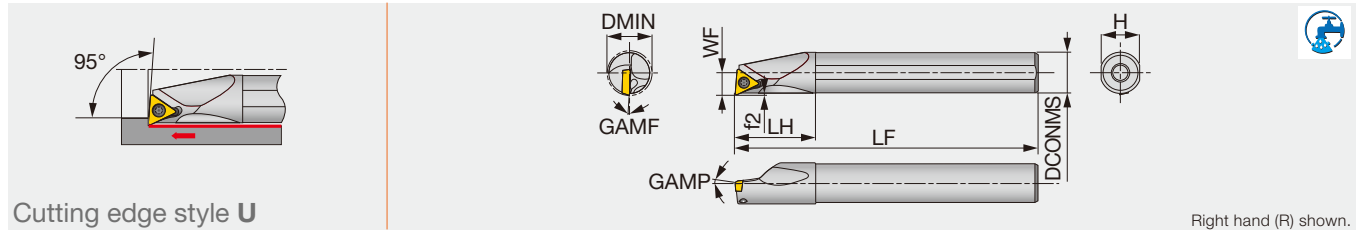

Cutting edge style U

Right hand (R) shown.

Designation	Material	DMIN	DCONMS	WF	LF	LH	H	f2	GAMP	GAMPF	RE**	Insert	Torque*
A07G-STUPR/L07-D080	Steel	8	7	4	90	12	6.75	0.4	5°	-10°	0.4	TP**0701...	0.9
A08H-STUPR/L07-D080	Steel	8	8	4	100	19.5	7.5	0.5	5°	-10°	0.4	TP**0701...	0.9
A08H-STUPR/L09-D100	Steel	10	8	5.5	100	16	7.5	0.6	5°	-8°	0.4	TP**0902... ⁽¹⁾	0.9
A10F-STUPR1102-D120	Steel	12	10	6.5	80	20	9	1.4	5°	-6°	0.4	TP**1102... ⁽¹⁾	1.2
A10K-STUPR/L1102-D120	Steel	12	10	6.5	125	20	9	0.7	5°	-6°	0.4	TP**1102... ⁽¹⁾	1.2
A10K-STUPR/L1103-D120	Steel	12	10	6.5	125	20	9	0.6	5°	-10°	0.4	TP**1103... ⁽¹⁾	1.4
A12H-STUPR1102-D140	Steel	14	12	7	100	24	11	0.8	5°	-4°	0.4	TP**1102... ⁽¹⁾	1.2
A12M-STUPR/L1102-D140	Steel	14	12	7	150	24	11	0.8	5°	-4°	0.4	TP**1102... ⁽¹⁾	1.2
A12M-STUPR/L13-D140	Steel	14	12	7	150	24	11	0.6	5°	-6°	0.4	TP**1103... ⁽¹⁾	1.4
A12H-STUPR1102-D160	Steel	16	12	9	100	24	11	0.6	5°	-3°	0.4	TP**1102... ⁽¹⁾	1.2
A12M-STUPR/L1102-D160	Steel	16	12	9	150	24	11	0.6	5°	-3°	0.4	TP**1102... ⁽¹⁾	1.2
A16K-STUPR13-D180	Steel	18	16	9	125	32	15	0.8	5°	-3°	0.4	TP**1303... ⁽¹⁾	1.4
A16Q-STUPR/L1103-D180	Steel	18	16	9	180	32	15	0.8	5°	-4°	0.4	TP**1103... ⁽¹⁾	1.4
A16Q-STUPR/L13-D180	Steel	18	16	9	180	32	15	0.8	5°	-3°	0.4	TP**1303... ⁽¹⁾	1.4
A16K-STUPR13-D200	Steel	20	16	11	125	32	15	0.6	5°	-3°	0.4	TP**1303... ⁽¹⁾	1.4
A16Q-STUPR/L13-D200	Steel	20	16	11	180	32	15	0.6	5°	-3°	0.4	TP**1303... ⁽¹⁾	1.4
A20R-STUPR/L1103-D220	Steel	22	20	11	200	36	18	0.7	5°	-2°	0.4	TP**1103... ⁽¹⁾	1.4
A20R-STUPR/L13-D220	Steel	22	20	11	200	36	18	0.7	5°	-2°	0.4	TP**1303... ⁽¹⁾	1.4
A25S-STUPR/L16-D270	Steel	27	25	13.5	250	45	23	0.5	5°	-1°	0.8	TP**16T3... ⁽¹⁾	3
A32T-STUPR/L16-D340	Steel	34	32	17	300	50	30	0.7	5°	0°	0.8	TP**16T3...	3
E07H-STUPR/L07-D080	Carbide	8	7	4	100	14	6.75	0.3	5°	-10°	0.4	TP**0701...	0.9
E08G-STUPR07-D080	Carbide	8	8	4	90	44.5	7.5	0.5	5°	-10°	0.4	TP**0701...	0.9
E08K-STUPR/L07-D080	Carbide	8	8	4	125	44.5	7.5	0.5	5°	-10°	0.4	TP**0701...	0.9
E08G-STUPR09-D100	Carbide	10	8	5.5	90	22	7	0.6	5°	-8°	0.4	TP**0902... ⁽¹⁾	0.9
E08K-STUPR/L09-D100	Carbide	10	8	5.5	125	22	7	0.6	5°	-8°	0.4	TP**0902... ⁽¹⁾	0.9
E10F-STUPR1102-D120	Carbide	12	10	6.5	80	25	9	0.5	5°	-6°	0.4	TP**1102... ⁽¹⁾	1.2
E10H-STUPR1102-D120	Carbide	12	10	6.5	100	25	9	0.6	5°	-6°	0.4	TP**1102... ⁽¹⁾	1.2
E10M-STUPR/L1102-D120	Carbide	12	10	6.5	150	25	9	0.6	5°	-6°	0.4	TP**1102... ⁽¹⁾	1.2
E10M-STUPR/L1103-D120	Carbide	12	10	6.5	150	25	9	0.7	5°	-10°	0.4	TP**1103... ⁽¹⁾	1.4
E12G-STUPR1102-D140	Carbide	14	12	7	90	27	11	0.8	5°	-4°	0.4	TP**1102... ⁽¹⁾	1.2
E12J-STUPR1102-D140	Carbide	14	12	7	110	27	11	0.8	5°	-4°	0.4	TP**1102... ⁽¹⁾	1.2
E12Q-STUPR/L1102-D140	Carbide	14	12	7	180	27	11	0.8	5°	-4°	0.4	TP**1102... ⁽¹⁾	1.2
E12Q-STUPR/L1103-D140	Carbide	14	12	7	180	27	11	0.7	5°	-6°	0.4	TP**1103... ⁽¹⁾	1.4
E12G-STUPR1102-D160	Carbide	16	12	9	90	27	11	0.6	5°	-3°	0.4	TP**1102... ⁽¹⁾	1.2
E12J-STUPR1102-D160	Carbide	16	12	9	110	27	11	0.6	5°	-3°	0.4	TP**1102... ⁽¹⁾	1.2
E12Q-STUPR/L1102-D160	Carbide	16	12	9	180	27	11	0.6	5°	-3°	0.4	TP**1102... ⁽¹⁾	1.2
E16H-STUPR13-D180	Carbide	18	16	9	100	32	15	0.9	5°	-3°	0.4	TP**1303... ⁽¹⁾	1.4
E16R-STUPR/L1103-D180	Carbide	18	16	9	200	32	15	0.8	5°	-3°	0.4	TP**1103... ⁽¹⁾	1.4
E16L-STUPR13-D180	Carbide	18	16	9	130	32	15	0.6	5°	-3°	0.4	TP**1303... ⁽¹⁾	1.4
E16R-STUPR/L13-D180	Carbide	18	16	9	200	32	15	0.6	5°	-3°	0.4	TP**1303... ⁽¹⁾	1.4
E16H-STUPR13-D200	Carbide	20	16	11	100	32	15	0.6	5°	-3°	0.4	TP**1303... ⁽¹⁾	1.4
E16L-STUPR13-D200	Carbide	20	16	11	130	32	15	0.6	5°	-3°	0.4	TP**1303... ⁽¹⁾	1.4
E16R-STUPR/L13-D200	Carbide	20	16	11	200	32	15	0.6	5°	-3°	0.4	TP**1303... ⁽¹⁾	1.4
E20S-STUPR1103-D220	Carbide	22	20	11	250	36	18	0.7	5°	-2°	0.4	TP**1103... ⁽¹⁾	1.4
E20S-STUPR13-D220	Carbide	22	20	11	250	36	18	0.6	5°	-2°	0.4	TP**1303... ⁽¹⁾	1.4
E25T-STUPR16-D270	Carbide	27	25	13.5	300	45	23	0.5	5°	-1°	0.8	TP**16T3...	3

*Torque: Recommended clamping torque (N·m)

**RE : Standard corner radius

Note: Use right-hand toolholders (STUPR**) with left-hand inserts (L); and left-hand toolholders (STUPL**) with right-hand inserts (R).

(1) TPGH, TPGM, and TPGA inserts cannot be used.

Reference pages: A/E-STUPR/L: Insert → **B142 -**, CBN → **B199 -**, PCD → **B216 -**



SPARE PARTS



Designation	Clamping screw	Wrench
A/E07*-STUPR/L07-...	CSTB-2.2L038	T-7F
A/E08*-STUPR/L07-...	CSTB-2.2L038	T-7F
A/E08*-STUPR/L09-...	CSTB-2.2L038	T-7F
A/E10*-STUPR/L1102-...	CSTB-2.5S	T-8F
A/E10*-STUPR/L1103-...	CSTB-3L050	T-9F
A/E12*-STUPR/L1102-...	CSTB-2.5B	T-8F
A/E12*-STUPR/L1103-...	CSTB-3L050	T-9F
A/E16*-STUPR/L1103-...	CSTB-3S	T-9F
A/E16*-STUPR/L13-...	CSTB-3S	T-9F
A/E20*-STUPR/L1103-...	CSTB-3S	T-9F
A/E20*-STUPR/L13-...	CSTB-3	T-9F
A/E25*-STUPR/L16-...	CSTB-4M	T-15F
A32*-STUPR/L16-...	CSTB-4M	T-15F

- L
- X
- J
- A
- K
- F
- U
- Q
- Z
- OTHERS

INSERT SELECTION

Application	Finishing	Finishing to medium cutting	Medium cutting
	Grade	NS9530	T9215
Breaker Shape	PSS	PS	PM
Cutting conditions	B016		

Application	Finishing	Finishing to medium cutting	Medium cutting
	Grade	AH6225	AH6225
Breaker Shape	PSS	PS	PM
Cutting conditions	B018		

Application	Finishing to medium cutting
Grade	T515
Breaker Shape	CM
Cutting conditions	B020

Application	Precision finishing
Grade	DX140
Breaker Shape	DIA <small>with rake</small>
Cutting conditions	B022

Application	Precision finishing
Grade	BX470
Breaker Shape	CBN
Cutting conditions	B024

Application	Precision finishing	Finishing
Grade	BXA10	BXA20
Breaker Shape	HP	HS
Cutting conditions	B026	

T-STUPR/L

Screw-on boring bar, for positive 60° triangular inserts (Tsuppari-Ichiban)

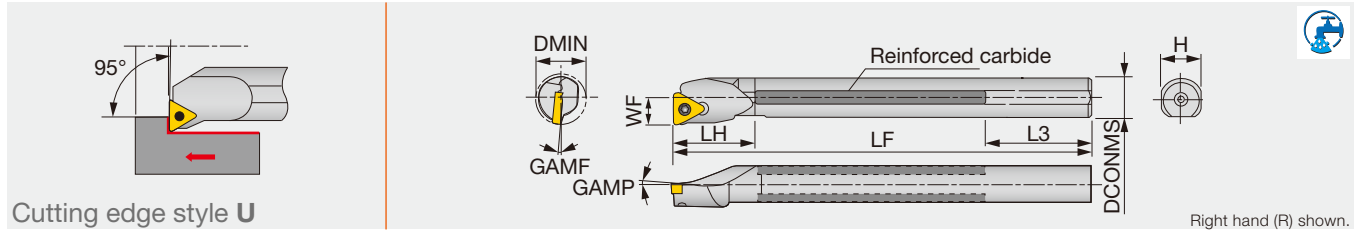

Designation	Material	DMIN	CNT	DCONMS	WF	LF	LH	L3	H	GAMP	GAMF	RE**	Insert	Torque*
T12M-STUPR11-D14	Reinforced	14	-	12	7	150	24	59	11	5°	-4°	0.4	TP**1102...	1.2
T12M-STUPR/L11	Reinforced	16	-	12	9	150	24	58	11	5°	-4°	0.4	TP**1102...	1.2
T16Q-STUPR13-D18	Reinforced	18	-	16	9	180	30	59	15	5°	-3.5°	0.4	TP**1303...	1.4
T16Q-STUPR/L13	Reinforced	20	-	16	11	180	30	59	15	5°	-3°	0.4	TP**1303...	1.4
T20R-STUPR13C-D22	Reinforced	22	Rc1/4	20	11	200	35	49	18	5°	-2°	0.4	TP**1303...	1.4
T20R-STUPR/L13	Reinforced	24	-	20	13	200	40	49	18	5°	-2°	0.4	TP**1303...	1.4
T25S-STUPR16C-D27	Reinforced	27	Rc1/4	25	13.5	250	40	64	23	5°	-1°	0.8	TP**16T3...	3
T25S-STUPR/L16	Reinforced	31	-	25	17	250	45	64	23	5°	0°	0.8	TP**16T3...	3

*Torque: Recommended clamping torque (N-m)

**RE : Standard corner radius

Note: Use right-hand toolholders (STUPR**) with left-hand inserts (L); and left-hand toolholders (STUPL**) with right-hand inserts (R).

SPARE PARTS

Designation	Clamping screw	Wrench
T12M-STUPR11-D14	CSTB-2.5B	T-8F
T12M-STUPR/L11	CSTB-2.5	T-8F
T16Q-STUPR13-D18	CSTB-3S	T-9F
T16Q-STUPR/L13	CSTB-3	T-9F
T20R-STUPR13C-D22	CSTB-3S	T-9F
T20R-STUPR/L13	CSTB-3	T-9F
T25S-STUPR/L16...	CSTB-4S	T-15F

INSERT SELECTION

Application	Finishing	Finishing to medium cutting	Medium cutting
	Grade	NS9530	T9215
Breaker Shape	PSS	PS	PM
Cutting conditions	B016		

Application	Finishing	Finishing to medium cutting	Medium cutting
	Grade	AH6225	AH6225
Breaker Shape	PSS	PS	PM
Cutting conditions	B018		

Application	Finishing to medium cutting
Grade	T515
Breaker Shape	CM
Cutting conditions	B020

Application	Precision finishing
Grade	DX140
Breaker Shape	DIA with rake
Cutting conditions	B022

Application	Precision finishing
Grade	BX470
Breaker Shape	CBN
Cutting conditions	B024

Application	Precision finishing	Finishing
Grade	BXA10	BXA20
Breaker Shape	HP	HS
Cutting conditions	B026	

Reference pages: T-STUPR/L: Insert → B142 -, CBN → B199 -, PCD → B216 -



STREAMJETBAR

A/E-SDUCR/L

Screw-on boring bar, for positive 55° rhombic inserts

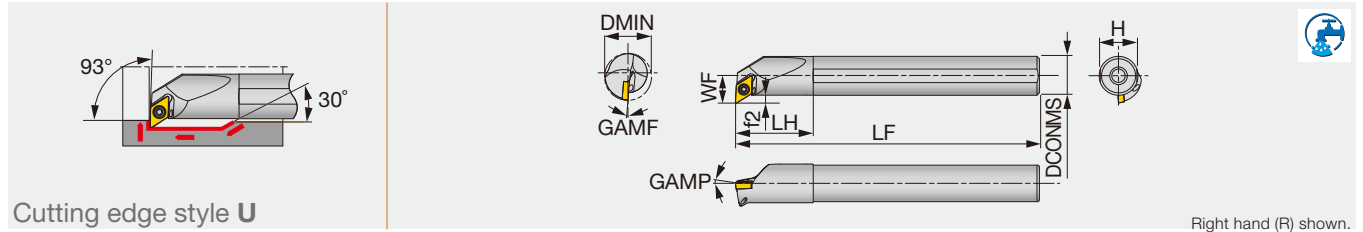

Cutting edge style U

Right hand (R) shown.

Designation	Material	DMIN	DCONMS	WF	LF	LH	H	f2	GAMP	GAMF	RE**	Insert	Torque*
A10K-SDUCR/L07-D130	Steel	13	10	7	125	20	9	2	0°	-10°	0.4	DC**0702...	1.2
A12M-SDUCR/L07-D160	Steel	16	12	9.3	150	24	11	3.3	0°	-6°	0.4	DC**0702...	1.2
A16Q-SDUCR/L07-D200	Steel	20	16	11.3	180	32	15	3.3	0°	-5°	0.4	DC**0702...	1.2
A20R-SDUCR/L11-D270	Steel	27	20	16.1	200	36	18	6.1	0°	-5°	0.8	DC**11T3...	3
A25S-SDUCR/L11-D320	Steel	32	25	18.6	250	45	23	6.1	0°	-4°	0.8	DC**11T3...	3
E10H-SDUCR07-D130	Carbide	13	10	7	100	25	9	1.9	5°	-3.5°	0.4	DC**0702...	1.2
E10M-SDUCR/L07-D130	Carbide	13	10	7	150	25	9	2	0°	-10°	0.4	DC**0702...	1.2
E12J-SDUCR07-D160	Carbide	16	12	9.3	110	27	11	3.2	0°	-6°	0.4	DC**0702...	1.2
E12Q-SDUCR/L07-D160	Carbide	16	12	9.3	180	27	11	3.3	0°	-6°	0.4	DC**0702...	1.2
E16L-SDUCR07-D200	Carbide	20	16	11.3	130	32	15	3.2	0°	-5°	0.4	DC**0702...	1.2
E16R-SDUCR/L07-D200	Carbide	20	16	11.3	200	32	15	3.3	0°	-5°	0.4	DC**0702...	1.2
E20S-SDUCR11-D270	Carbide	27	20	16.1	250	36	18	6.1	0°	-5°	0.8	DC**11T3...	3

*Torque: Recommended clamping torque (N·m)

**RE : Standard corner radius

Note: Use right-hand toolholders (SDUCR**) with left-hand inserts (L); and left-hand toolholders (SDUCL**) with right-hand inserts (R).

SPARE PARTS

Designation	Clamping screw	Wrench
A1**-SDUCR/L07-D1*0	CSTB-2.5S	T-8F
A16Q-SDUCR/L07-D200	CSTB-2.5	T-8F
A2**-SDUCR/L11-D**0	CSTB-4S	T-15F
E1**-SDUCR/L07-D1*0	CSTB-2.5S	T-8F
E16*-SDUCR/L07-D200	CSTB-2.5	T-8F
E20S-SDUCR11-D270	CSTB-4S	T-15F

INSERT SELECTION

Application	Precision finishing	Finishing		Finishing to medium cutting
	Grade	SH725	SH725	NS9530
Breaker Shape	JP	JS	PSS	PS
Cutting conditions	B016			

Application	Precision finishing	Finishing		Finishing to medium cutting
	Grade	SH725	SH725	AH6225
Breaker Shape	JP	JS	PSS	PS
Cutting conditions	B018			

Application	Medium cutting
Grade	T9215
Breaker Shape	PM
Cutting conditions	B016

Application	Medium cutting
Grade	AH6225
Breaker Shape	PM
Cutting conditions	B018

Application	Finishing to medium cutting
Grade	T515
Breaker Shape	CM
Cutting conditions	B020

Application	Precision finishing	Finishing	Finishing to medium cutting
Grade	DX120	DX140	KS05F
Breaker Shape	DIA with rake	AL	
Cutting conditions	B022		

Application	Precision finishing	Finishing	Finishing to medium cutting
Grade	BX470	AH8005	AH8015
Breaker Shape	CBN	PS	PS
Cutting conditions	B024		

Application	Precision finishing	Finishing
Grade	BXA10	BXA20
Breaker Shape	HP	HS
Cutting conditions	B026	

Reference pages: A/E-SDUCR/L: Insert → B119 -, CBN → B182, PCD → B194 -

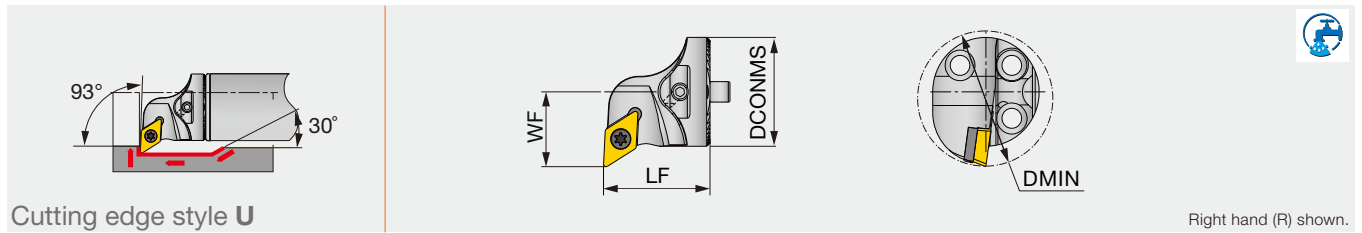

Cutting edge style **U**

Right hand (R) shown.

Designation	DMIN	DCONMS	WF	LF	Shank	Insert
S16-SDUCR/L07-H	20	16	11	20	D/G16	DC**0702...
S20-SDUCR/L11-H	25	20	13	20	D/G20	DC**11T3...
S25-SDUCR/L11-H	32	25	17	20	D25	DC**11T3...
S32-SDUCR/L11T-H	40	32	22	32	D32	DC**11T3...
S40-SDUCR/L11T-H	50	40	27	32	D40, D50, D60	DC**11T3...

Note: Use right-hand toolholders (SDUCR**) with left-hand inserts (L); and left-hand toolholders (SDUCL**) with right-hand inserts (R).

SPARE PARTS					
Designation	Clamping screw	Wrench	Shim	Shim screw	
S16-SDUCR/L07-H	SR14-548	T-7/5	-	-	
S20-SDUCR/L11-H	SR16-236P	T-15/5	-	-	
S25-SDUCR/L11-H	SR16-236P	T-15/5	-	-	
S32-SDUCR/L11T-H	SR16-236P	T-15/5	TDC3-1P	SRTC-3P	
S40-SDUCR/L11T-H	SR16-236P	T-15/5	TDC3-1P	SRTC-3P	

INSERT SELECTION

P	Application	Precision finishing	Finishing		Finishing to medium cutting
	Grade	SH725	SH725	NS9530	T9215
	Breaker Shape	JP	JS	PSS	PS
	Cutting conditions	B016			
M	Application	Precision finishing	Finishing		Finishing to medium cutting
	Grade	SH725	SH725	AH6225	AH6225
	Breaker Shape	JP	JS	PSS	PS
	Cutting conditions	B018			
P	Application	Medium cutting			
	Grade	T9215			
	Breaker Shape	PM			
	Cutting conditions	B016			
M	Application	Medium cutting			
	Grade	AH6225			
	Breaker Shape	PM			
	Cutting conditions	B018			
K	Application	Finishing to medium cutting			
	Grade	T515			
	Breaker Shape	CM			
	Cutting conditions	B020			
N	Application	Precision finishing	Finishing	Finishing to medium cutting	
	Grade	DX120	DX140	KS05F	
	Breaker Shape	DIA	with rake	AL	
	Cutting conditions	B022			
S	Application	Precision finishing	Finishing	Finishing to medium cutting	
	Grade	BX470	AH8005	AH8015	
	Breaker Shape	CBN	PS	PS	
	Cutting conditions	B024			
H	Application	Precision finishing	Finishing		
	Grade	BXA10	BXA20		
	Breaker Shape	HP	HS		
	Cutting conditions	B026			

Reference pages: S-SDUCR/L-H: Insert → **B121 -**, CBN → **B193 -**, PCD → **B214**
Shank → **D090 - D092**

STREAMJETBAR

A/E-SDUPR/L

Screw-on boring bar, for positive 55° rhombic inserts

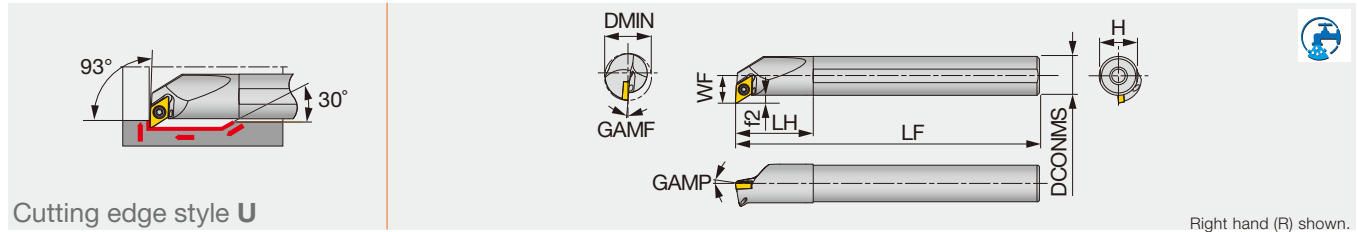

Cutting edge style U

Right hand (R) shown.

Designation	Material	DMIN	DCONMS	WF	LF	LH	H	f2	GAMP	GAMF	RE**	Insert	Torque*
A12M-SDUPR07-D150-P	Special alloy steel	15	12	8.3	150	24	11	2.3	5	0	0.4	DPMT0702...	1.2
A12M-SDUPL07-D150-P	Special alloy steel	15	12	8.3	150	24	11	2.3	5	0	0.4	DPMT0702...	1.2
A12M-SDUPR07-D180-P	Special alloy steel	18	12	10.3	150	24	11	4.3	5	0	0.4	DPMT0702...	1.2
A12M-SDUPL07-D180-P	Special alloy steel	18	12	10.3	150	24	11	4.3	5	0	0.4	DPMT0702...	1.2
A16Q-SDUPR07-D220-P	Special alloy steel	22	16	12.3	180	32	15	4.3	5	0	0.4	DPMT0702...	1.2
A16Q-SDUPL07-D220-P	Special alloy steel	22	16	12.3	180	32	15	4.3	5	0	0.4	DPMT0702...	1.2
E12Q-SDUPR07-D150	Carbide	15	12	8.3	180	27	11	2.3	5	0	0.4	DPMT0702...	1.2
E12Q-SDUPL07-D150	Carbide	15	12	8.3	180	27	11	2.3	5	0	0.4	DPMT0702...	1.2
E12Q-SDUPR07-D180	Carbide	18	12	10.3	180	27	11	4.3	5	0	0.4	DPMT0702...	1.2
E12Q-SDUPL07-D180	Carbide	18	12	10.3	180	27	11	4.3	5	0	0.4	DPMT0702...	1.2
E16R-SDUPR07-D220	Carbide	22	16	12.3	200	32	15	4.3	5	0	0.4	DPMT0702...	1.2
E16R-SDUPL07-D220	Carbide	22	16	12.3	200	32	15	4.3	5	0	0.4	DPMT0702...	1.2

*Torque: Recommended clamping torque (N-m)

**RE : Standard corner radius

Note: Use right-hand toolholders (SCLPR**) with left-hand inserts (L); and left-hand toolholders (SCLPL**) with right-hand inserts (R).

U

SPARE PARTS

Designation	Clamping screw	Wrench
A**-SDUPR/L07-D**0-P	CSTB-2.5S	T-8F
E**-SDUPR/L07-D**0	CSTB-2.5S	T-8F

INSERT SELECTION

P

Application	Finishing	Finishing to medium cutting
Grade	NS9530	T9215
Breaker Shape	PS	PS
Cutting conditions	B016	

M

Application	Finishing	Finishing to medium cutting
Grade	AH6225	AH6225
Chipbreaker shape	PS	PS
Cutting conditions	B018	

K

Application	Finishing	Finishing to medium cutting
Grade	NS9530	T9215
Breaker Shape	PS	PS
Cutting conditions	B020	

S

Application	Finishing	Finishing to medium cutting
Grade	AH8015	AH8015
Breaker Shape	PS	PS
Cutting conditions	B024	

Reference pages: A/E-SDUPR/L: Insert → **B126**

STREAMJETBAR

A/E-SVUBR/L

Screw-on boring bar, for positive 35° rhombic inserts

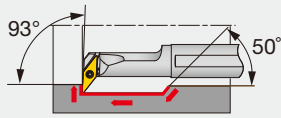

Cutting edge style U

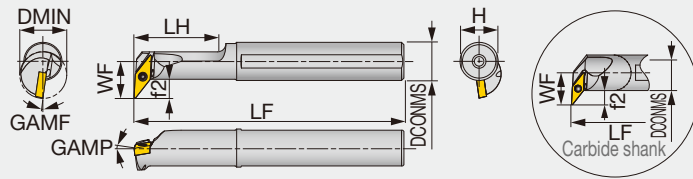

Right hand (R) shown.

Designation	Material	DMIN	DCONMS	WF	LF	LH	H	f2	GAMP	GAMF	RE**	Insert	Torque*
A16Q-SVUBR/L11-D200	Steel	20	16	15.5	180	35	15	8	0°	-8°	0.4	VB**1103...	1.2
A20R-SVUBR/L11-D250	Steel	25	20	17.5	200	40	19	8	0°	-7°	0.4	VB**1103...	1.2
A25S-SVUBR/L16-D320	Steel	32	25	20.5	250	50	23	8.5	0°	-6°	0.8	VB**1604...	3
E16R-SVUBR/L11-D245	Carbide	24.5	16	16	200	-	15	8	0°	-8°	0.4	VB**1103...	1.2
E20S-SVUBR/L11-D285	Carbide	28.5	20	18	250	-	19	8	0°	-7°	0.4	VB**1103...	1.2
E25T-SVUBR/L16-D340	Carbide	34	25	21	300	-	23	8.5	0°	-6°	0.8	VB**1604...	3

*Torque: Recommended clamping torque (N-m)

**RE : Standard corner radius

Note: Use right-hand toolholders (SVUBR**) with left-hand inserts (L); and left-hand toolholders (SVUBL**) with right-hand inserts (R).

SPARE PARTS

Designation	Clamping screw	Wrench
A**-SVUBR/L11-D2*0	CSTB-2.5	T-8F
A25S-SVUBR/L16-D320	CSTB-3.5	T-15F
E**-SVUBR/L11-D2*5	CSTB-2.5	T-8F
E25T-SVUBR/L16-D340	CSTB-3.5	T-15F

INSERT SELECTION

Application	Precision finishing	Finishing		Finishing to medium cutting
	Grade	SH725	SH725	NS9530
Breaker Shape	JP	JS	PSS	PS
Cutting conditions	B014			

Application	Precision finishing	Finishing		Finishing to medium cutting
	Grade	SH725	SH725	AH6225
Chipbreaker shape	JP	JS	PSS	PS
Cutting conditions	B016			

Application	Medium cutting
Grade	T9215
Breaker Shape	PS
Cutting conditions	B014

Application	Medium cutting
Grade	AH6225
Chipbreaker shape	PS
Cutting conditions	B016

Application	Finishing to medium cutting	Application	Finishing	Finishing to medium cutting
	Grade		Grade	Grade
Breaker Shape	T515	PS	AH8005	AH8015
Cutting conditions	B020	PS	PS	B024

Application	Precision finishing	Finishing
	Grade	Grade
Breaker Shape	BXA10	BXA20
Cutting conditions	HP	HS
Cutting conditions	B026	

Reference pages: A/E-SVUBR/L: Insert → B150 -, CBN → B207 -



T-SVUBR

Screw-on boring bar, for positive 35° rhombic inserts (Tsuppari-Ichiban)

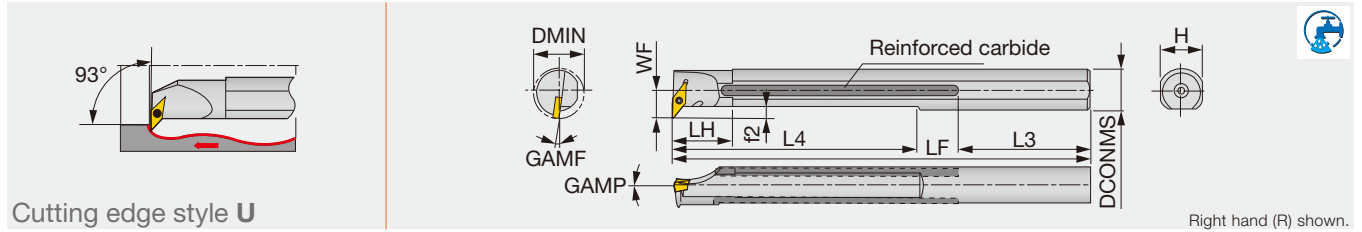

Designation	Material	DMIN	CNT	DCONMS	WF	LF	LH	L3	L4	H	f2	GAMP	GAMF	RE**	Insert	Torque*
T20R-SVUBR11C	Reinforced	25	Rc1/4	20	14	200	30	59	121	18	4	0°	-8°	0.4	VB**1103...	1.2

*Torque: Recommended clamping torque (N·m)
 **RE : Standard corner radius
 Note: Use right-hand toolholders (SVUBR**) with left-hand inserts (L).

SPARE PARTS

Designation	Clamping screw	Wrench
T20R-SVUBR11C	CSTB-2.5	T-8F

INSERT SELECTION

Application	Precision finishing	Finishing		Finishing to medium cutting
	Grade	SH725	SH725	NS9530
Breaker Shape	JP	JS	PSS	PS
Cutting conditions	B014			

Application	Precision finishing	Finishing		Finishing to medium cutting
	Grade	SH725	SH725	AH6225
Chipbreaker shape	JP	JS	PSS	PS
Cutting conditions	B016			

Application	Medium cutting
Grade	T9215
Breaker Shape	PS
Cutting conditions	B014

Application	Medium cutting
Grade	AH6225
Chipbreaker shape	PS
Cutting conditions	B016

Application	Finishing to medium cutting	Application	Finishing	Finishing to medium cutting
	Grade		Grade	Grade
Breaker Shape	T515	PS	AH8005	AH8015
Cutting conditions	B020	Cutting conditions	B024	

Application	Precision finishing	Finishing
	Grade	Grade
Breaker Shape	BXA10	BXA20
Cutting conditions	B026	

Reference pages: T-SVUBR: Insert → **B150** -, CBN → **B207** -

STREAMJETBAR

A/E-SVUCR/L

Screw-on boring bar, for positive 35° rhombic inserts

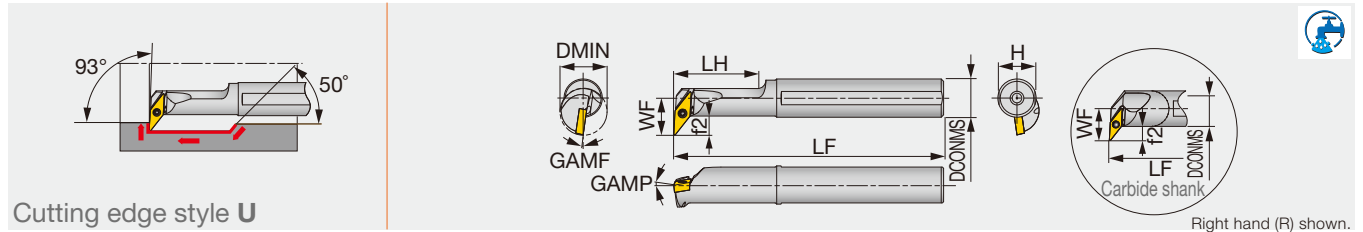

Designation	Material	DMIN	DCONMS	WF	LF	LH	H	f2	GAMP	GAMF	RE**	Insert	Torque*
A12M-SVUCR/L08-D160	Steel	16	12	11	150	30	11	5.5	0°	-8°	0.4	VC**0802...	0.6
A25S-SVUCR/L16-D320	Steel	32	25	19	250	45	23	6.5	0°	-5°	0.8	VC**1604...	3
E12Q-SVUCR/L08-D180	Carbide	18	12	11.5	180	-	11	5.5	0°	-8°	0.4	VC**0802...	0.6
E25T-SVUCR/L16-D320	Carbide	32	25	19	300	-	23	6.5	0°	-5°	0.8	VC**1604...	3

*Torque: Recommended clamping torque (N-m)

**RE : Standard corner radius

Note: Use right-hand toolholders (SVUCR**) with left-hand inserts (L); and left-hand toolholders (SVUCL**) with right-hand inserts (R).

SPARE PARTS

Designation	Clamping screw	Wrench
A12M-SVUCR/L08-D160	CSTB-2L	T-6F
A25S-SVUCR/L16-D320	CSTB-3.5	T-15F
E12Q-SVUCR/L08-D180	CSTB-2L	T-6F
E25T-SVUCR/L16-D320	CSTB-3.5	T-15F

INSERT SELECTION

P

Application	Finishing	Finishing to medium cutting
Grade	NS9530	T9215
Breaker Shape	PSS	PS
Cutting conditions	B016	

M

Application	Finishing	Finishing to medium cutting
Grade	AH6225	AH6225
Chipbreaker shape	PSS	PS
Cutting conditions	B018	

K

Application	Finishing to medium cutting
Grade	T515
Breaker Shape	CM
Cutting conditions	B020

N

Application	Precision finishing	Finishing	Medium cutting
Grade	DX120	DX140	KS05F
Breaker Shape	DIA	with rake DIA	AL
Cutting conditions	B022		

S

Application	Finishing	Finishing to medium cutting
Grade	AH8005	AH8015
Breaker Shape	PS	PS
Cutting conditions	B024	

H

Application	Precision finishing	Finishing
Grade	BXA10	BXA20
Breaker Shape	CBN	CBN
Cutting conditions	B026	

Reference pages: A/E-SVUCR/L: Insert → B152 -, CBN → B209, PCD → B220



T-SVUCR

Screw-on boring bar, for positive 35° rhombic inserts (Tsuppari-Ichiban)

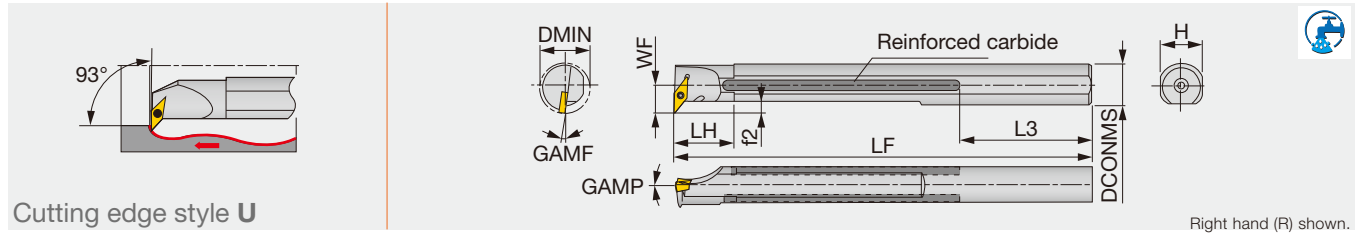

Designation	Material	DMIN	CNT	DCONMS	WF	LF	LH	L3	H	f2	GAMP	GAMF	RE**	Insert	Torque*
T25S-SVUCR16C	Reinforced	32	Rc1/4	25	19	250	40	64	23	6.5	0°	-5°	0.8	VC**1604...	3

*Torque: Recommended clamping torque (N·m)
 **RE : Standard corner radius
 *The hole specification of applicable inserts conforms to ISO standard.
 Note: Use right-hand toolholders (SVUCR**) with left-hand inserts (L).

SPARE PARTS

Designation	Clamping screw	Wrench
T25S-SVUCR16C	CSTB-3.5L	T-15F

- L
- X
- J
- A
- K
- F
- U
- Q
- Z
- OTHERS

INSERT SELECTION

P	Application	Finishing	Finishing to medium cutting	M	Application	Finishing	Finishing to medium cutting
	Grade	NS9530	T9215		Grade	AH6225	AH6225
	Breaker Shape	PSS	PS		Chipbreaker shape	PSS	PS
	Cutting conditions	B016			Cutting conditions	B018	
K	Application	Finishing to medium cutting	N	Application	Precision finishing	Finishing	Medium cutting
	Grade	T515		Grade	DX120	DX140	KS05F
	Breaker Shape	CM		Breaker Shape	DIA	with rake DIA	AL
	Cutting conditions	B020			Cutting conditions		
S	Application	Finishing	Finishing to medium cutting	H	Application	Precision finishing	Finishing
	Grade	AH8005	AH8015		Grade	BXA10	BXA20
	Breaker Shape	PS	PS		Breaker Shape	CBN	CBN
	Cutting conditions	B024			Cutting conditions		

Reference pages: T-SVUCR: Insert → B152 -, CBN → B209, PCD → B220

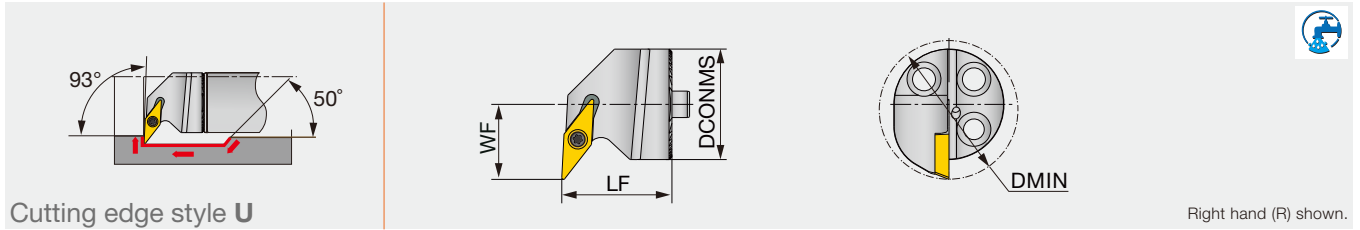

Cutting edge style **U**

Right hand (R) shown.

Designation	DMIN	DCONMS	WF	LF	Shank	Insert
S20-SVUCR/L11-H	27	20	16	20	D/G20	VC**1103...
S25-SVUCR/L11-H	31	25	17	25	D25	VC**1103...

Note: Use right-hand toolholders (SVUCR**) with left-hand inserts (L); and left-hand toolholders (SVUCL**) with right-hand inserts (R).

SPARE PARTS



Designation	Clamping screw	Wrench
S20-SVUCR/L11-H	SR14-560	T-8/5
S25-SVUCR/L11-H	SR14-560	T-8/5

INSERT SELECTION

P	Application	Finishing	Finishing to medium cutting
	Grade	NS9530	T9215
	Breaker Shape		
	Cutting conditions	B016	

M	Application	Finishing	Finishing to medium cutting
	Grade	AH6225	AH6225
	Chipbreaker shape		
	Cutting conditions	B018	

K	Application	Finishing to medium cutting
	Grade	T515
	Breaker Shape	
	Cutting conditions	B020

N	Application	Precision finishing	Finishing	Medium cutting
	Grade	DX120	DX140	KS05F
	Breaker Shape			
	Cutting conditions	B022		

S	Application	Finishing	Finishing to medium cutting
	Grade	AH8005	AH8015
	Breaker Shape		
	Cutting conditions	B024	

H	Application	Precision finishing	Finishing
	Grade	BXA10	BXA20
	Breaker Shape		
	Cutting conditions	B026	

Reference pages: S-SVUCR/L-H: Insert → **B152 -**, CBN → **B209**, PCD → **B220**
Shank → **D090 - D092**



Y-PRO SERIES

A/E-SYUBR/L

Screw-on boring bar, for positive 25° rhombic inserts

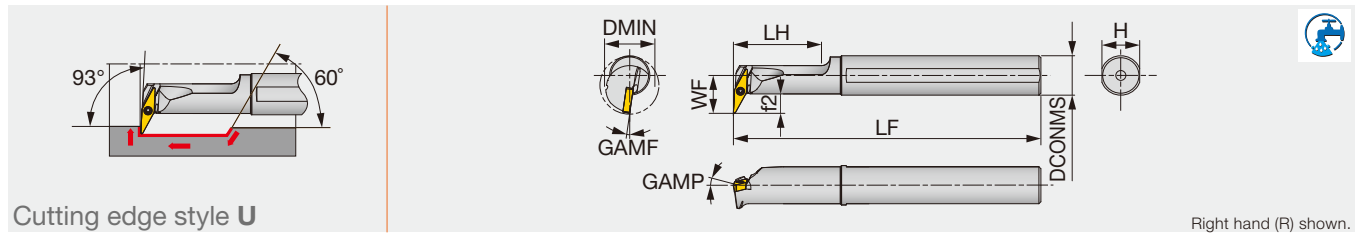

Designation	Material	DMIN	DCONMS	WF	LF	LH	H	f2	GAMP	GAMF	RE**	Insert	Torque*
A16Q-SYUBR/L11-D200	Steel	20	16	15.5	180	35	15	8	0°	-8°	0.4	YW**11T2...	0.6
E12Q-SYUBR/L11-D200	Carbide	20	12	13.5	180	27	11	7.5	0°	-8°	0.4	YW**11T2...	0.6
E16R-SYUBR/L11-D245	Carbide	24.5	16	16	200	32	15	8	0°	-8°	0.4	YW**11T2...	0.6

*Torque: Recommended clamping torque (N-m)

**RE : Standard corner radius

SPARE PARTS

Designation	Clamping screw	Wrench
A16Q-SYUBR/L11-D200	CSTB-2L	T-6F
E**SYUBR/L11-D...	CSTB-2L	T-6F

INSERT SELECTION

Application	Finishing	Finishing to medium cutting	Medium cutting
	Grade	GT9215	T9215
Breaker Shape	ZF	ZF	ZM
Cutting conditions	B016		

Application	Finishing	Finishing to medium cutting	Medium cutting
	Grade	AH8015	AH8015
Breaker Shape	ZF	ZF	ZM
Cutting conditions	B018		

Application	Finishing	Finishing to medium cutting	Medium cutting
	Grade	GT9530	T9215
Breaker Shape	ZF	ZF	ZM
Cutting conditions	B020		

Application	Finishing	Finishing to medium cutting	Medium cutting
	Grade	AH8015	AH8015
Breaker Shape	ZF	ZF	ZM
Cutting conditions	B024		

Reference pages: A/E-SYUBR/L: Insert → **B159**

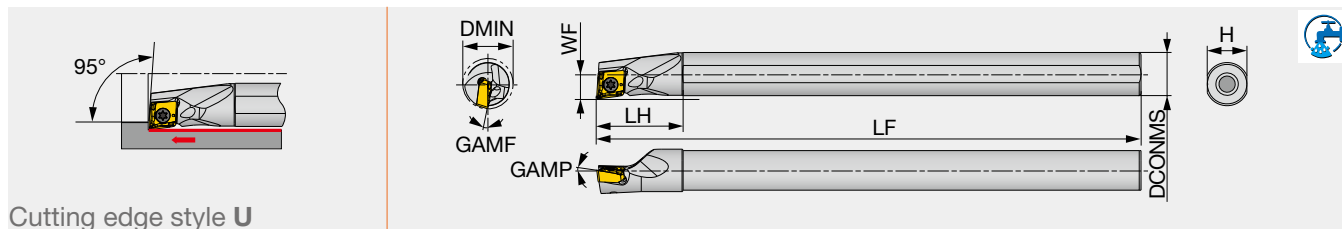

Cutting edge style **U**

Designation	DMIN	DCONMS	WF	LF	LH	H	GAMP	GAMF	Insert
A08H-SXUOR/L05-D100	10	8	5	100	16	7.5	-7°	-0.8°	XOMU05X204-PS
A12M-SXUOR/L07-D140	14	12	7	150	24	11	-7.2°	3.2°	XOMU07H304-PS
E08K-SXUOR/L05-D100	10	8	5	125	22	7.5	-7°	-0.8°	XOMU05X204-PS
E12Q-SXUOR/L07-D140	14	12	7	180	27	11	-7.2°	3.2°	XOMU07H304-PS

SPARE PARTS

Designation	Clamping screw	Wrench
A08H-SXUOR/L05-D100	CSTB-2L040	T-6F
A12M-SXUOR/L07-D140	CSPB-2.5	IP-8D
E08K-SXUOR/L05-D100	CSTB-2L040	T-6F
E12Q-SXUOR/L07-D140	CSPB-2.5	IP-8D

TBM

Maximum hole depth for LH/DC = 2.25

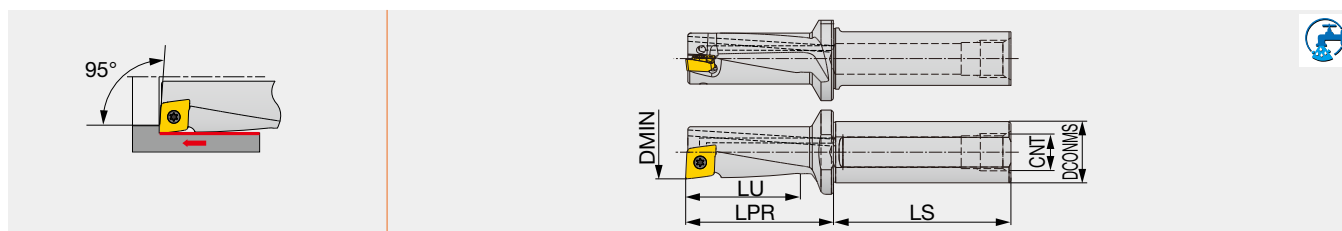

Designation	DMIN	DCONMS	LU	LS	LPR	CNT	Insert
TBM10R/LF12-2.25	10	12	22.5	41.5	28.45	UNF 5/16-24	XOMU05X204-PS
TBM12R/LF16-2.25	12	16	27	43.9	33.53	G1/8	XOMU06H204-PS
TBM14R/LF16-2.25	14	16	31.5	46.4	38.57	G1/8	XOMU07H304-PS
TBM16R/LF20-2.25	16	20	36	57.1	42.9	G1/8	XOMU08T304-PS

SPARE PARTS

Designation	Clamping screw	Wrench
TBM10R/LF12-2.25	CSTB-2L040	T-6D
TBM12R/LF16-2.25	CSPB-2.2	IP-7D
TBM14R/LF16-2.25	CSPB-2.5	IP-8D
TBM16R/LF20-2.25	CSTB-3	T-9D

Reference pages: Insert → **D066**
Standard cutting conditions → **D098**



BOREMEISTER

S-SXUOR05-H

Screw-on clamp exchangeable boring head, for XOMU inserts

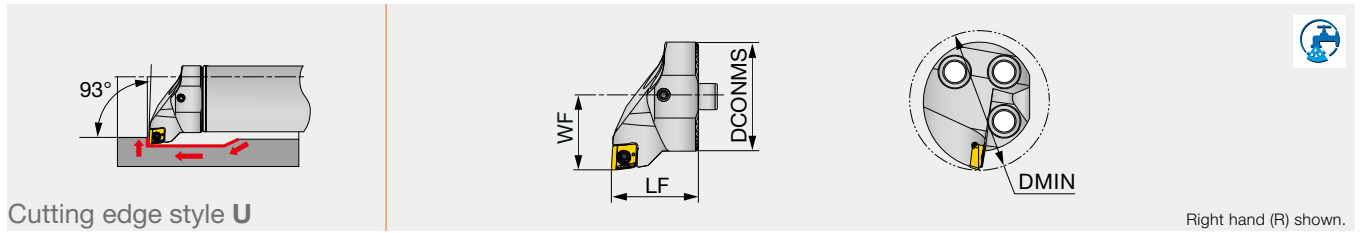

Cutting edge style U

Right hand (R) shown.

Designation	DMIN	DCONMS	WF	LF	Shank	Insert
S20-SXUOR05-H	25	20	13	20	D20	XOMU05X204-PS
S25-SXUOR05-H	32	25	17	20	D25	XOMU05X204-PS

SPARE PARTS

Designation	Clamping screw	Wrench
S**-SXUOR05-H	CSTB-2L040	T-6F

INSERT

XOMU-PS

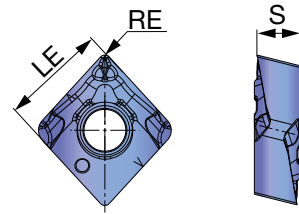

P	Steel	★																		
M	Stainless	★																		
K	Cast iron	★																		
N	Non-ferrous	★																		
S	Superalloys																			
H	Hard materials																			

★ : First choice
☆ : Second choice

Designation	RE	Coated										S	LE		
		AH725													
XOMU05X204-PS	0.4	●												2.3	5.56
XOMU06H204-PS	0.4	●												2.7	6.3
XOMU07H304-PS	0.4	●												3.3	7.3
XOMU08T304-PS	0.4	●												4	8.3

● : Line up

Reference pages: Shank → **D090 - D092**
Standard cutting conditions → **D098**

STREAMJETBAR

A-PTUNR/L

Lever-lock boring bar, for negative 60° triangular inserts

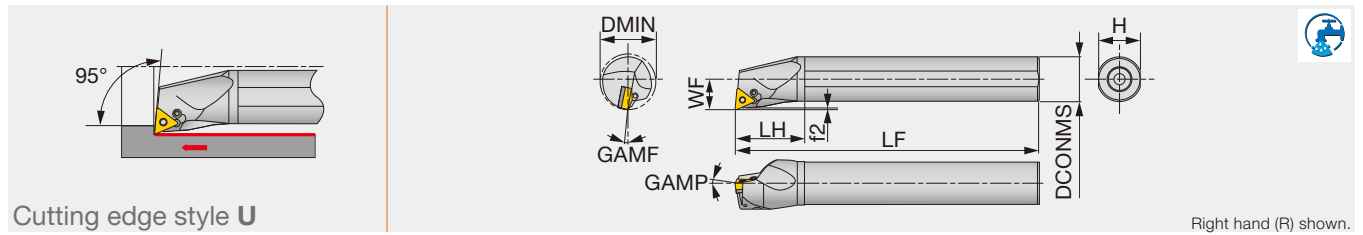

Cutting edge style U

Right hand (R) shown.

Designation	Material	DMIN	DCONMS	WF	LF	LH	H	f2	GAMP	GAMF	RE**	Insert	Torque*
A25R-PTUNR/L1104-D320	Steel	32	25	17	200	45	23	1.22	-6°	-12°	0.8	TN**1104...	2
A32S-PTUNR/L1104-D400	Steel	40	32	22	250	50	30	1.16	-6°	-10°	0.8	TN**1104...	2
A16M-PTUNR/L11-D200	Steel	20	16	11	150	32	15	1	-6°	-14°	0.4	TN**1103...	1.7
A20Q-PTUNR/L11-D250	Steel	25	20	13	180	36	18	1	-6°	-12°	0.4	TN**1103...	1.7
A25R-PTUNR/L16-D320	Steel	32	25	17	200	45	23	1.4	-6°	-12°	0.8	TN**1604...	2.7
A32S-PTUNR/L16-D400	Steel	40	32	22	250	50	30	1.3	-6°	-10°	0.8	TN**1604...	2.7

*Torque: Recommended clamping torque (N-m) **RE : Standard corner radius

*The hole specification of applicable inserts conforms to ISO standard.

Toolholder length may not conform to ISO standard.

Note: Use right-hand toolholders (PTUNR**) with left-hand inserts (L); and left-hand toolholders (PTUNL**) with right-hand inserts (R).

Designation	Shim	Clamping screw 1	Clamping screw 2	Wrench 1	Wrench 2	Spring pin	Lever	Oil supply attachment*	Screw for oil hole*
A25R-PTUNR/L1104-D320	-	LCS23A	-	-	P-2.5	-	LCL23	EA-25	SSH4-5
A32S-PTUNR/L1104-D400	-	LCS23A	-	-	P-2.5	-	LCL23	EA-32	SSH4-5
A16M-PTUNR/L11-D200	-	LCS22A	-	P-2F	-	-	LCL22N	-	SSH3-4
A20Q-PTUNR/L11-D250	-	LCS22A	-	P-2F	-	-	LCL22N	EA-20	SSH3-4
A25R-PTUNR/L16-D320	ELST317BR/L	-	LCS3	-	P-2.5	LSP3	LCL33	EA-25	SSH4-5
A32S-PTUNR/L16-D400	LST317BR/L	-	LCS3	-	P-2.5	LSP3	LCL3	EA-32	SSH4-5

*Optional

A/S-PTUNR/L

Lever-lock boring bar, for negative 60° triangular inserts

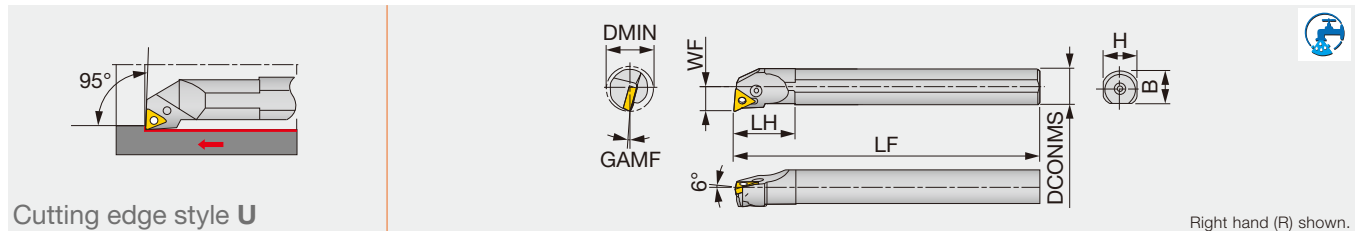

Cutting edge style U

Right hand (R) shown.

Designation	Material	DMIN	DCONMS	WF	LF	LH	H	B	GAMF	RE**	Insert	Torque*
S16M-PTUNR/L11	Steel	20	16	11	150	30	15	15.5	-14°	0.4	TN**1103...	1.7
S20Q-PTUNR/L11	Steel	25	20	13	180	35	18	19	-12°	0.4	TN**1103...	1.7
S25R-PTUNR/L16	Steel	32	25	17	200	40	23	24	-12°	0.8	TN**1604...	2.7
A32S-PTUNR/L16	Steel	40	32	22	250	50	30	29.5	-12°	0.8	TN**1604...	2.7

*Torque: Recommended clamping torque (N-m) **RE : Standard corner radius

*The hole specification of applicable inserts conforms to ISO standard.

Toolholder length may not conform to ISO standard.

Note: Use right-hand toolholders (R) with left-hand inserts (L); and left-hand toolholders (L) with right-hand inserts (R).

Designation	Shim	Clamping screw 1	Clamping screw 2	Wrench 1	Wrench 2	Spring pin	Lever	Oil supply attachment*
S**-PTUNR/L11	-	LCS22A	-	P-2F	-	-	LCL22N	-
S25R-PTUNR16	ELST317BR	-	LCS3	-	P-2.5	LSP3	LCL33	-
S25R-PTUNL16	ELST317BL	-	LCS3	-	P-2.5	LSP3	LCL33	-
A32S-PTUNR16	LST317BR	-	LCS3	-	P-2.5	LSP3	LCL3	EA-32
A32S-PTUNL16	LST317BL	-	LCS3	-	P-2.5	LSP3	LCL3	EA-32

*Optional

Reference pages: A-PTUNR/L, A/S-PTUNR/L: Insert → B087 -, CBN → B182 -, PCD → B212

T-PTUNR

Lever-lock boring bar, for negative 60° triangular inserts (Tsuppari-Ichiban)

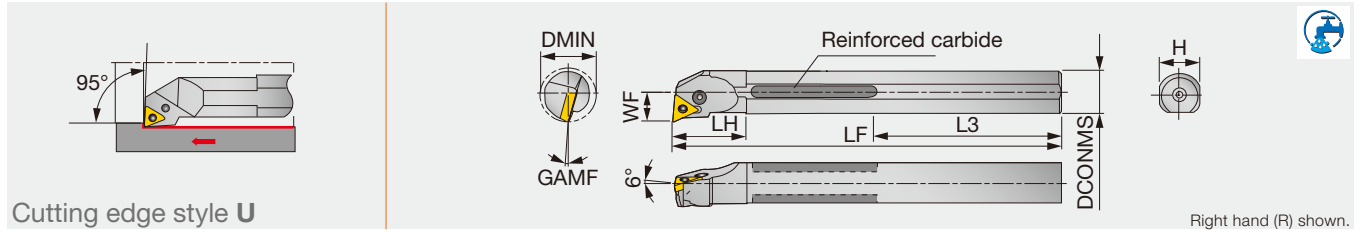

Designation	Material	DMIN	CNT	DCONMS	WF	LF	LH	L3	H	GAMF	RE**	Insert	Torque*
T16Q-PTUNR11	Reinforced	20	-	16	11	180	27	59	15	-14°	0.4	TN**1103...	1.7
T20R-PTUNR11C	Reinforced	25	Rc1/4	20	13	200	35	49	18	-12°	0.4	TN**1103...	1.7
T25S-PTUNR16C	Reinforced	32	Rc1/4	25	17	250	40	64	23	-12°	0.8	TN**1604...	2.7
T32U-PTUNR16C	Reinforced	40	Rc1/2	32	22	350	50	103	30	-10°	0.8	TN**1604...	2.7
T40V-PTUNR16C	Reinforced	50	Rc1/2	40	27	400	55	88	37	-10°	0.8	TN**1604...	2.7
T50W-PTUNR16C	Reinforced	63	Rc1/2	50	35	450	65	63	47	-8°	0.8	TN**1604...	2.7

*Torque: Recommended clamping torque (N-m)

**RE : Standard corner radius

*The hole specification of applicable inserts conforms to ISO standard.

Toolholder length may not conform to ISO standard.

Note: Use right-hand toolholders (R) with left-hand inserts (L); and left-hand toolholders (L) with right-hand inserts (R).

Designation	Shim	Clamping screw 1	Clamping screw 2	Wrench 1	Wrench 2	Spring pin	Lever
T**-PTUNR11...	-	LCS22A	-	P-2F	-	-	LCL22N
T25S-PTUNR16C	ELST317BR	-	LCS3	-	P-2.5	LSP3	LCL33
T**-PTUNR16C	LST317BR	-	LCS3	-	P-2.5	LSP3	LCL3

INSERT SELECTION

Application	Precision finishing	Finishing	Medium cutting	Medium to heavy cutting
	Grade	NS9530	GT9530	T9215
Breaker Shape	TF	TSF	TM	TH
Cutting conditions	B004			

Application	Finishing	Medium cutting
	Grade	T6215
Breaker Shape	SF	SM
Cutting conditions	B006	

Application	Finishing	Medium cutting	Medium to heavy cutting
	Grade	T515	T515
Breaker Shape	All-round	All-round	All-round
Cutting conditions	B008		

Application	Precision finishing	Finishing	Medium cutting
	Grade	DX120	DX140
Breaker Shape	DIA	with rake T-DIA	P
Cutting conditions	B010		

Application	Precision finishing	Finishing	Medium cutting
	Grade	BX470	AH8005
Breaker Shape	CBN	HRF	HRM
Cutting conditions	B012		

Application	Precision finishing	Finishing
	Grade	BXA10
Breaker Shape	HP	HS
Cutting conditions	B014	

Reference pages: T-PTUNR: Insert → B087 -, CBN → B182 -, PCD → B212

STREAMJETBAR

A-PDUNR/L

Lever-lock boring bar, for negative 55°/45° rhombic inserts

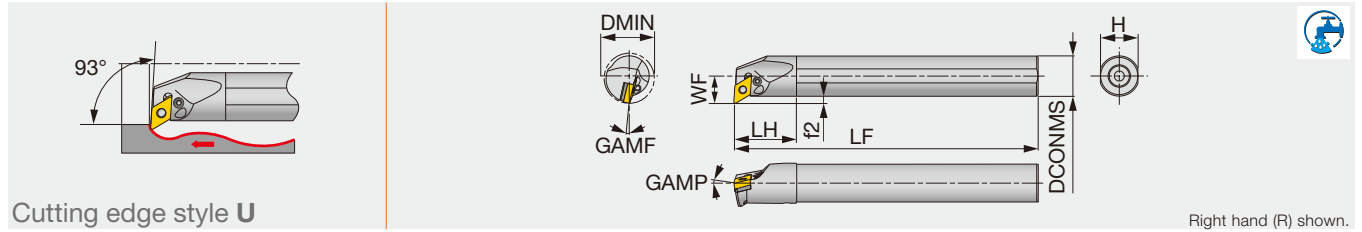

Cutting edge style U

Right hand (R) shown.

Designation	Material	DMIN	DCONMS	WF	LF	LH	H	f2	GAMP	GAMF	RE**	Insert	Torque*
A20Q-PDUNR/L1104-D250	Steel	25	20	13	180	36	18	3	-6°	-14°	0.8	DN**/FNMG1104...	1.7
A20Q-PDUNR/L11-D250	Steel	25	20	13	180	36	18	3	-6°	-14°	0.8	DN**/FNMG1104...	1.7
A25R-PDUNR/L11-D320	Steel	32	25	17	200	45	23	4.5	-6°	-12°	0.8	DN**/FNMG1104...	2.7
A32S-PDUNR/L15-D400	Steel	40	32	22	250	50	30	6	-6°	-13°	0.8	DN**/FNGA1504...	4.8
A40T-PDUNR/L15-D500	Steel	50	40	27	300	60	37	7	-6°	-10°	0.8	DN**/FNGA1504...	4.8
A50U-PDUNR/L15-D630	Steel	63	50	35	350	65	47	10	-6°	-8°	0.8	DN**/FNGA1504...	4.8
A32S-PDUNR/L1506-D400	Steel	40	32	22	250	50	30	6	-6°	-13°	0.8	DN**/FNGA1506...	4.8
A40T-PDUNR/L1506-D500	Steel	50	40	27	300	60	37	7	-6°	-11°	0.8	DN**/FNGA1506...	4.8
A50U-PDUNR/L1506-D630	Steel	63	50	35	350	65	47	10	-6°	-10°	0.8	DN**/FNGA1506...	4.8

*Torque: Recommended clamping torque (N-m)

**RE : Standard corner radius

Note: Use right-hand toolholders (PDUNR**) with left-hand inserts (L); and left-hand toolholders (PDUNL**) with right-hand inserts (R).

SPARE PARTS

Designation	Shim	Clamping screw 1	Clamping screw 2	Wrench 1	Wrench 2	Spring pin	Lever	Oil supply attachment*	Screw for oil hole*
A20Q-PDUNR/L1104-D250	-	LCS22A	-	P-2F	-	-	LCL33NL	EA-20	SSHM2.5-3
A20Q-PDUNR/L11-D250	-	LCS22A	-	P-2F	-	-	LCL33NL	EA-20	SSHM2.5-3
A25R-PDUNR/L11-D320	ELSD317BR/L	-	LCS3	-	P-2.5	LSP3	LCL33L	EA-25	SSHM3-4
A32S-PDUNR/L15-D400	LSD42BR/L	-	LCS4	-	P-3	LSP4	LCL4	EA-32	SSHM5-6
A40T-PDUNR/L15-D500	LSD42BR/L	-	LCS4	-	P-3	LSP4	LCL4	-	SSHM6-6
A50U-PDUNR/L15-D630	LSD42BR/L	-	LCS4	-	P-3	LSP4	LCL4	-	SSHM6-6
A32S-PDUNR/L1506-D400	ELSD42	-	ELCS4	-	P-3	LSP4S	LCL44	EA-20	SSHM5-6
A40T-PDUNR/L1506-D500	ELSD42	-	ELCS4	-	P-3	LSP4S	LCL44	-	SSHM6-6
A50U-PDUNR/L1506-D630	ELSD42	-	ELCS4	-	P-3	LSP4S	LCL44	-	SSHM6-6

*Optional

INSERT SELECTION

P	Application	Precision finishing	Finishing	Medium cutting	Medium to heavy cutting
	Grade	NS9530	GT9530	T9215	T9215
	Breaker Shape	TF	TSF	TM	TH
	Cutting conditions	B004			
M	Application	Finishing	Medium cutting	Medium to heavy cutting	
	Grade	T6215	AH6225	AH6225	
	Chipbreaker shape	SF	SM	SH	
	Cutting conditions	B006			
K	Application	Finishing	Medium cutting	Medium to heavy cutting	
	Grade	T515	T515	T515	
	Breaker Shape	All-round	All-round	All-round	
	Cutting conditions	B008			
N	Application	Precision finishing	Finishing	Medium cutting	
	Grade	DX120	DX140	TH10	
	Breaker Shape	DIA	with rake T-DIA	P	
	Cutting conditions	B010			
S	Application	Precision finishing	Finishing	Medium cutting	
	Grade	BX470	AH8005	AH8005	
	Breaker Shape	CBN	HRF	HRM	
	Cutting conditions	B012			
H	Application	Precision finishing	Finishing		
	Grade	BXA10	BXA20		
	Breaker Shape	HP	HS		
	Cutting conditions	B014			

Reference pages: A-PDUNR/L: Insert → B066 -, B075, CBN → B172 -, PCD → B211

S-PDUNR/L

Lever-lock boring bar, for negative 55°/45° rhombic inserts

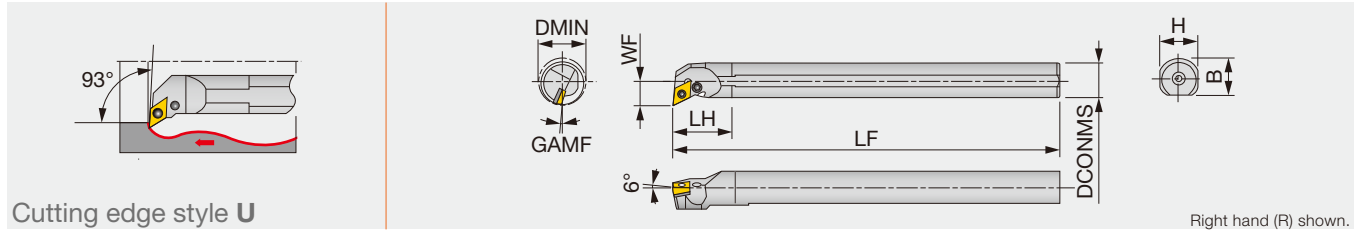

Designation	Material	DMIN	DCONMS	WF	LF	LH	H	B	GAMF	RE**	Insert
S20Q-PDUNR/L11	Steel	25	20	13	180	35	18	19	-14°	0.8	DN**/FNMG1104...
S25R-PDUNR/L11	Steel	32	25	17	200	40	23	24	-12°	0.8	DN**/FNMG1104...
S32S-PDUNR/L15	Steel	40	32	22	250	50	30	29.5	-13°	0.8	DN**/FNGA1504...
S40T-PDUNR/L15	Steel	50	40	27	300	55	37	37.5	-10°	0.8	DN**/FNGA1504...
S50U-PDUNR/L15	Steel	63	50	35	350	65	47	47.5	-8°	0.8	DN**/FNGA1504...

**RE : Standard corner radius

Note: Use right-hand toolholders (R) with left-hand inserts (L); and left-hand toolholders (L) with right-hand inserts (R).

SPARE PARTS

Designation	Shim	Clamping screw 1	Clamping screw 2	Wrench 1	Wrench 2	Spring pin	Lever
S20Q-PDUNR/L11	-	LCS22A	-	P-2F	-	-	LCL33NL
S25R-PDUNR11	ELSD317BR	-	LCS3	-	P-2.5	LSP3	LCL33L
S25R-PDUNL11	ELSD317BL	-	LCS3	-	P-2.5	LSP3	LCL33L
S32S-PDUNR15	LSD42BR	-	LCS4	-	P-3	LSP4	LCL4
S32S-PDUNL15	LSD42BL	-	LCS4	-	P-3	LSP4	LCL4
S40T-PDUNR15	LSD42BR	-	LCS4	-	P-3	LSP4	LCL4
S40T-PDUNL15	LSD42BL	-	LCS4	-	P-3	LSP4	LCL4
S50U-PDUNR15	LSD42BR	-	LCS4	-	P-3	LSP4	LCL4
S50U-PDUNL15	LSD42BL	-	LCS4	-	P-3	LSP4	LCL4

INSERT SELECTION

P	Application	Precision finishing	Finishing	Medium cutting	Medium to heavy cutting
	Grade	NS9530	GT9530	T9215	T9215
	Breaker Shape	TF	TSF	TM	TH
	Cutting conditions	B004			
M	Application	Finishing	Medium cutting	Medium to heavy cutting	
	Grade	T6215	AH6225	AH6225	
	Chipbreaker shape	SF	SM	SH	
	Cutting conditions	B006			
K	Application	Finishing	Medium cutting	Medium to heavy cutting	
	Grade	T515	T515	T515	
	Breaker Shape	All-round	All-round	All-round	
	Cutting conditions	B008			
N	Application	Precision finishing	Finishing	Medium cutting	
	Grade	DX120	DX140	TH10	
	Breaker Shape	DIA	with rake DIA	P	
	Cutting conditions	B010			
S	Application	Precision finishing	Finishing	Medium cutting	
	Grade	BX470	AH8005	AH8005	
	Breaker Shape	CBN	HRF	HRM	
	Cutting conditions	B012			
H	Application	Precision finishing	Finishing		
	Grade	BXA10	BXA20		
	Breaker Shape	HP	HS		
	Cutting conditions	B014			

Reference pages: S-PDUNR/L: Insert → B066 -, B075, CBN → B172 -, PCD → B211

T-PDUNR

Lever-lock boring bar, for negative 55°/45° rhombic inserts (Tsuppari-Ichiban)

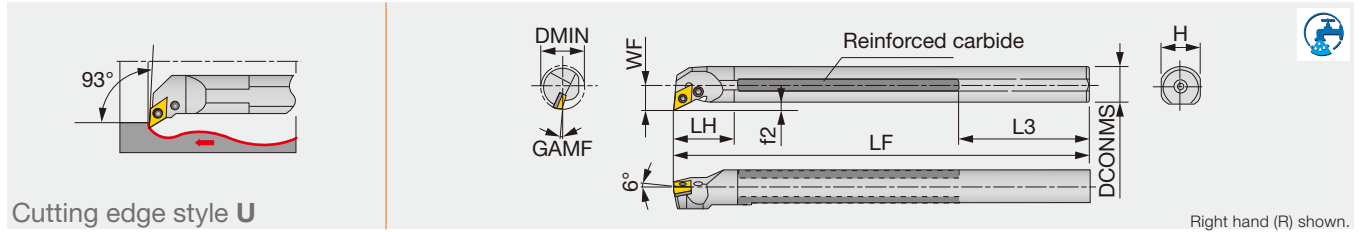

Cutting edge style U

Right hand (R) shown.

Designation	Material	DMIN	CNT	DCONMS	WF	LF	LH	L3	H	f2	GAMF	RE**	Insert
T32U-PDUNR15C	Reinforced	40	Rc1/2	32	22	350	50	103	30	6	-13°	0.8	DN**/FNGA1504...
T40V-PDUNR15C	Reinforced	50	Rc1/2	40	27	400	55	88	37	7	-10°	0.8	DN**/FNGA1504...
T50W-PDUNR15C	Reinforced	63	Rc1/2	50	35	450	65	63	47	10	-8°	0.8	DN**/FNGA1504...

**RE : Standard corner radius

Note: Use right-hand toolholders (R) with left-hand inserts (L); and left-hand toolholders (L) with right-hand inserts (R).

SPARE PARTS

Designation	Shim	Clamping screw	Wrench	Spring pin	Lever
T**-PDUNR15C	LSD42BR	LCS4	P-3	LSP4	LCL4

TUNGCAP

C-PDUNL-CHP

Lever-lock boring bar with TungCap connection, with 93° approach angle, for negative 55°/45° rhombic inserts, with high pressure coolant capability

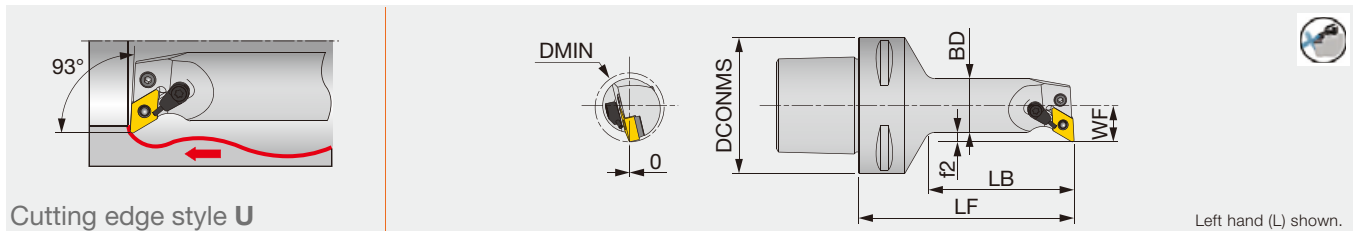

Cutting edge style U

Left hand (L) shown.

Designation	DMIN	DCONMS	BD	LF	LB	WF	f2	RE**	Insert
C6PDUNL17100-1104-CHP	32	63	25	100	67.5	17	4.5	0.8	DN**/FNMG1104...

Applicable for 14 MPa coolant

**RE : Standard corner radius

SPARE PARTS

Designation	Shim	Clamping screw	Coolant unit	Wrench	Spring pin	Lever
C6PDUNL17100-1104-CHP	ELSD317BL	LCS43	S-CU-CHP	P-2.5	LSP3	LCL33L

INSERT SELECTION

Application	Precision finishing	Finishing	Medium cutting	Medium to heavy cutting
	Grade	NS9530	GT9530	T9215
Breaker Shape	TF	TSF	TM	TH
Images				
Cutting conditions	B004			

Application	Finishing	Medium cutting	Medium to heavy cutting
	Grade	T6215	AH6225
Chipbreaker shape	SF	SM	SH
Images			
Cutting conditions	B006		

Application	Finishing	Medium cutting	Medium to heavy cutting
	Grade	T515	T515
Breaker Shape	All-round	All-round	All-round
Images			
Cutting conditions	B008		

Application	Precision finishing	Finishing	Medium cutting
	Grade	DX120	DX140
Breaker Shape	DIA	DIA with rake	P
Images			
Cutting conditions	B010		

Application	Precision finishing	Finishing	Medium cutting
	Grade	BX470	AH8005
Breaker Shape	CBN	HRF	HRM
Images			
Cutting conditions	B012		

Application	Precision finishing	Finishing
	Grade	BXA10
Breaker Shape	HP	HS
Images		
Cutting conditions	B014	

Reference pages: T-PDUNR, C-PDUNL-CHP: Insert → B066 -, B075, CBN → B172 -, PCD → B211

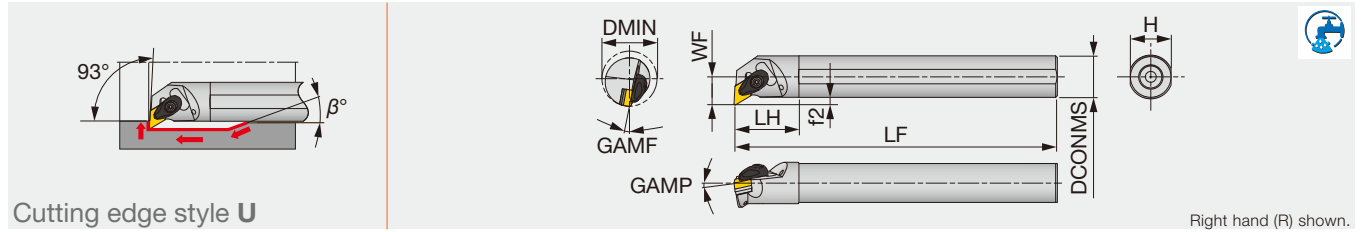

Designation	Material	DMIN	DCONMS	WF	LF	LH	H	f2	GAMP	GAMF	β°	RE**	Insert	Torque*
A25R-ADUNR/L1104-D320	Steel	32	25	17	200	45	23	4.5	-6°	-13°	20	0.8	DN**/FNMG1104...	3
A32S-ADUNR/L1104-D400	Steel	40	32	22	250	50	30	6	-6°	-11°	20	0.8	DN**/FNMG1104...	3
A25R-ADUNR/L15-D320	Steel	32	25	17	200	45	23	4.5	-6°	-13°	30	0.8	DN**/FNGA1504...	3
A32S-ADUNR/L15-D400	Steel	40	32	22	250	50	30	6	-6°	-11°	20	0.8	DN**/FNGA1504...	3
A40T-ADUNR15-D500	Steel	50	40	27	300	55	37	7	-6°	-8°	15	0.8	DN**/FNGA1504...	3
A50U-ADUNR15-D630	Steel	63	50	35	350	65	47	10	-6°	-7°	15	0.8	DN**/FNGA1504...	3
A25R-ADUNR/L1506-D320	Steel	32	25	17	200	45	23	4.5	-6°	-13°	15	0.8	DN**/FNGA1506...	3
A32S-ADUNR/L1506-D400	Steel	40	32	22	250	50	30	6	-6°	-11°	20	0.8	DN**/FNGA1506...	3

*Torque: Recommended clamping torque (N·m)

**RE : Standard corner radius

Designation	Clamp	Clamp screw	Spring	Spring pin	Shim	Shim screw	Wrench
A**-ADUNR/L1104-D...	ACP3S-E	ACS-5W	BP-7	SP-2.5	ASD322	CSTB-3.5	T-15F
A**-ADUNR/L15-D...	ACP4S	ACS-5W	BP-7	SP-2.5	ASD432	CSTB-3.5	T-15F
A**-ADUNR/L1506-D...	ACP4S	ACS-5W	BP-7	SP-2.5	ASD423	CSTB-3.5	T-15F

INSERT SELECTION

P	Application	Precision finishing	Finishing	Medium cutting	Medium to heavy cutting
	Grade	NS9530	GT9530	T9215	T9215
	Breaker Shape	TF	TSF	TM	TH
	Cutting conditions	B004			
M	Application	Finishing	Medium cutting	Medium to heavy cutting	
	Grade	T6215	AH6225	AH6225	
	Chipbreaker shape	SF	SM	SH	
	Cutting conditions	B006			
K	Application	Finishing	Medium cutting	Medium to heavy cutting	
	Grade	T515	T515	T515	
	Breaker Shape	All-round	All-round	All-round	
	Cutting conditions	B008			
N	Application	Precision finishing	Finishing	Medium cutting	
	Grade	DX120	DX140	TH10	
	Breaker Shape	DIA	DIA with rake	P	
	Cutting conditions	B010			
S	Application	Precision finishing	Finishing	Medium cutting	
	Grade	BX470	AH8005	AH8005	
	Breaker Shape	CBN	HRF	HRM	
	Cutting conditions	B012			
H	Application	Precision finishing	Finishing		
	Grade	BXA10	BXA20		
	Breaker Shape	HP	HS		
	Cutting conditions	B014			

Reference pages: A-ADUNR/L: Insert → **B066 -**, **B075**, CBN → **B172 -**, PCD → **B211**

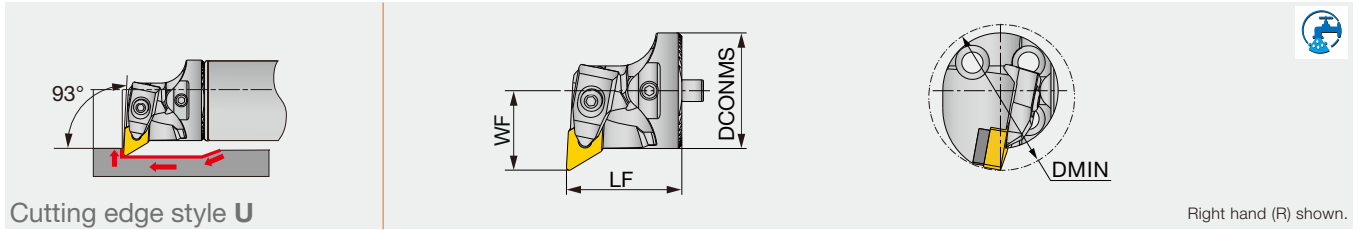

Designation	DMIN	DCONMS	WF	LF	Shank size	Insert
S32-DDUNR/L11T-H	40	32	22	32	D32	DN**/FNMG1104...
S40-DDUNR/L15T-H ⁽¹⁾	50	40	27	38	D40, D50, D60	DN**/FNGA1506(04)...

Note: When using a right or left hand insert, the right hand insert (R) is used for the left hand toolholders (DDUNL** type), and the left hand insert (L) is used for the right hand toolholders (DDUNR** type).
 (1) DN**/FNGA1504... inserts require a separate shim (# RDT443).

SPARE PARTS

Designation	Shim 1	Shim 2 (Optional)	Shim screw	Clamp	Clamping screw	Spring	Wrench
S32-DDUNR/L11T-H	RDT3-2	-	SR40085I	LCGR-3	SRRC3	KSP3	HW2.5
S40-DDUNR/L15T-H	RDT433	(RDT443)	SR14-506	DLM4	DLS4	DSP4	HW3.0

INSERT SELECTION

Application	Precision finishing	Finishing	Medium cutting	Medium to heavy cutting
	Grade	NS9530	GT9530	T9215
Breaker Shape	TF	TSF	TM	TH
Cutting conditions	B004			

Application	Finishing	Medium cutting	Medium to heavy cutting
	Grade	T6215	AH6225
Chipbreaker shape	SF	SM	SH
Cutting conditions	B006		

Application	Finishing	Medium cutting	Medium to heavy cutting
	Grade	T515	T515
Breaker Shape	All-round	All-round	All-round
Cutting conditions	B008		

Application	Precision finishing	Finishing	Medium cutting
	Grade	DX120	DX140
Breaker Shape	T-DIA	with rake T-DIA	P
Cutting conditions	B010		

Application	Precision finishing	Finishing	Medium cutting
	Grade	BX470	AH8005
Breaker Shape	CBN	HRF	HRM
Cutting conditions	B012		

Application	Precision finishing	Finishing
	Grade	BXA10
Breaker Shape	HP	HS
Cutting conditions	B014	

Reference pages: S-DDUNR/L-H: Insert → B066 -, B075, CBN → B172 -, PCD → B211
 Shank → D090 - D092



STREAMJETBAR

A-PVUNR/L-Eco

Lever-lock boring bar, for negative 35°/25° rhombic inserts

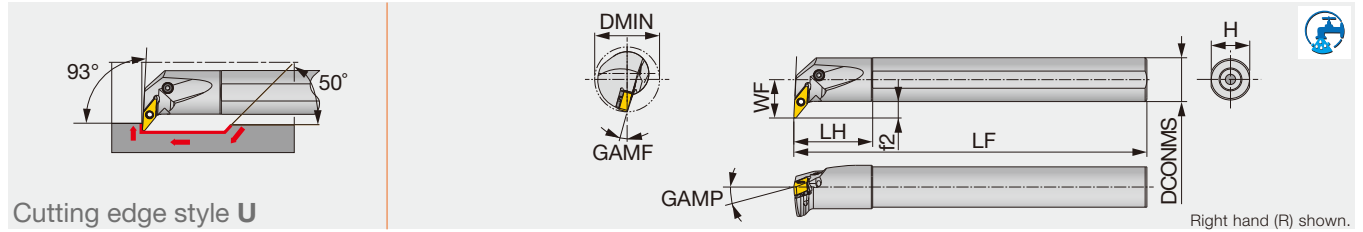

Designation	Material	DMIN	DCONMS	WF	LF	LH	H	f2	GAMP	GAMF	RE**	Insert	Torque*
A25R-PVUNR/L1204-D320	Steel	32	25	18	200	45	23	5.0	-5°	-15°	0.8	VN**1204...	3
A25R-PVUNR/L1204-D370	Steel	37	25	22	200	45	23	8.0	-4°	-15°	0.8	VN**1204...	3
A32S-PVUNR/L1204-D400	Steel	40	32	22	250	50	30	5.5	-6°	-12°	0.8	VN**1204...	3
A25R-PVUNR/L16-D370	Steel	37	25	22	200	45	23	9.5	-5°	-14°	0.8	VN**/YN**1604...	2.7
A32S-PVUNR/L16-D400	Steel	40	32	22	250	50	30	6	-5°	-12°	0.8	VN**/YN**1604...	2.7
A40T-PVUNR/L16-D500	Steel	50	40	27	300	60	37	7	-5°	-10°	0.8	VN**/YN**1604...	2.7

*Torque: Recommended clamping torque (N-m)

**RE: Standard corner radius

SPARE PARTS

Designation	Shim	Clamping screw	Wrench	Spring pin	Lever	Oil supply attachment*	Screw for oil hole*
A25R-PVUNR/L1204-D...	LSV212	LCS3V	P-2.5	LSP3	LCL3V	EA-25	SSHM4-5
A32S-PVUNR/L1204-D400	LSV212	LCS3V	P-2.5	LSP3	LCL3V	EA-32	SSHM4-5
A25R-PVUNR/L16-D370	LSV317BR/L	LCS3V	P-2.5	LSP3	LCL3V	EA-25	SSHM4-5
A32S-PVUNR/L16-D400	LSV317BR/L	LCS3V	P-2.5	LSP3	LCL3V	EA-32	SSHM4-5
A40T-PVUNR/L16-D500	LSV317BR/L	LCS3V	P-2.5	LSP3	LCL3V	-	SSHM5-6

*Optional

INSERT SELECTION

Application	Precision finishing	Finishing	Medium cutting
	Grade	NS9530	GT9530
Breaker Shape	TF	TSF	TM
Cutting conditions	B004		

Application	Finishing	Medium cutting
	Grade	T6215
Chipbreaker shape	SF	SM
Cutting conditions	B006	

Application	Finishing	Medium cutting	Medium to heavy cutting
	Grade	T515	T515
Breaker Shape	All-round	All-round	All-round
Cutting conditions	B008		

Application	Precision finishing
Grade	DX120
Breaker Shape	DIA with rake
Cutting conditions	B010

Application	Precision finishing	Finishing	Medium cutting
	Grade	BX470	AH8005
Breaker Shape	CBN	HRF	HRM
Cutting conditions	B012		

Application	Precision finishing	Finishing
	Grade	BXA10
Breaker Shape	HP	HS
Cutting conditions	B014	

Reference pages: A-PVUNR/L: Insert → B098 -, B110, CBN → B186 -, PCD → B188

TURNINGA

A-AVUNR/L

Double-clamp boring bar, for negative 35°/25° rhombic inserts

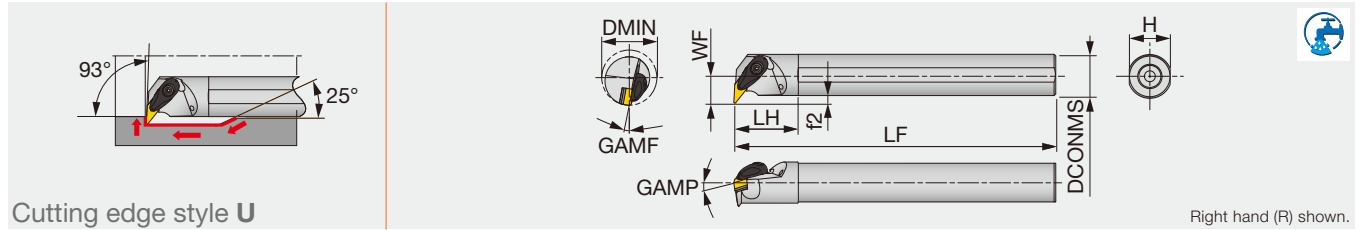

Cutting edge style U

Designation	Material	DMIN	DCONMS	WF	LF	LH	H	f2	GAMP	GAMF	RE**	Insert	Torque*
A32S-AVUNR/L16-D400	Steel	40	32	22	250	50	30	6	-6°	-10°	0.8	VN**/YN**1604...	3
A40T-AVUNR/L16-D500	Steel	50	40	27	300	55	37	7	-6°	-8°	0.8	VN**/YN**1604...	3

*Torque: Recommended clamping torque (N-m)
 **RE : Standard corner radius

SPARE PARTS

Designation	Clamp	Clamp screw	Spring	Spring pin	Shim	Shim screw	Wrench
A**-AVUNR/L16-D...	ACP3L	ACS-5W	BP-7	SP-2.5	ASV322	CSTB-3.5	T-15F

BOREMEISTER

S-DVUNR/L-H

Double-clamp exchangeable boring head, for negative 35° rhombic inserts

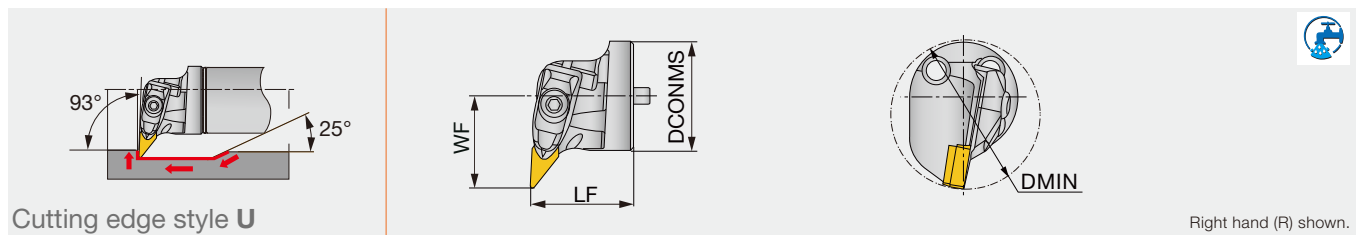

Cutting edge style U

Designation	DMIN	DCONMS	WF	LF	Shank	Insert
S40-DVUNR/L16T-H	56	40	34	38	D40, D50, D60	VN**1604...

SPARE PARTS

Designation	Shim	Shim screw	Clamp	Clamp screw	Spring	Wrench
S40-DVUNR/L16T-H	ASV322	SR35080I	DLM3V	SR10402267	KSP5	HW4.0

INSERT SELECTION

Application	Precision finishing	Finishing	Medium cutting
	Grade	NS9530	GT9530
Breaker Shape	TF	TSF	TM
Cutting conditions	B004		

Application	Finishing	Medium cutting
	Grade	T6215
Chipbreaker shape	SF	SM
Cutting conditions	B006	

Application	Finishing	Medium cutting	Medium to heavy cutting
	Grade	T515	T515
Breaker Shape	All-round	All-round	All-round
Cutting conditions	B008		

Application	Precision finishing
	Grade
Breaker Shape	DIA
Cutting conditions	B010

Application	Precision finishing	Finishing	Medium cutting
	Grade	BX470	AH8005
Breaker Shape	CBN	HRF	HRM
Cutting conditions	B012		

Application	Precision finishing	Finishing
	Grade	BXA10
Breaker Shape	HP	HS
Cutting conditions	B014	

Reference pages: A-AVUNR/L, S-DVUNR/L-H: Insert → B098 -, B110, CBN → B186 -, PCD → B192
 Shank → D090 - D092



STREAMJETBAR

A/E-SDQCR/L

Screw-on boring bar, for positive 55° rhombic inserts

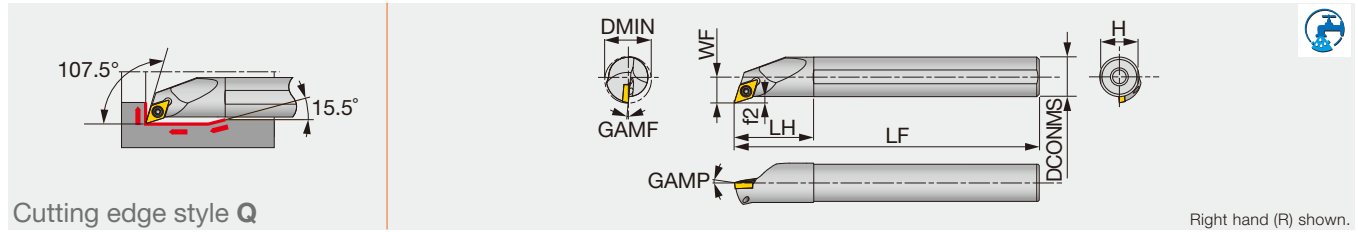

Designation	Material	DMIN	DCONMS	WF	LF	LH	H	f2	GAMP	GAMF	RE**	Insert	Torque*
A10K-SDQCR/L07-D130	Steel	13	10	7.6	125	20	9	2.6	0°	-8°	0.4	DC**0702...	1.2
A12M-SDQCR/L07-D160	Steel	16	12	8.6	150	24	11	2.6	0°	-6°	0.4	DC**0702...	1.2
A16Q-SDQCR/L07-D200	Steel	20	16	10.6	180	32	15	2.6	0°	-5°	0.4	DC**0702...	1.2
A20R-SDQCR/L11-D250	Steel	25	20	13.7	200	36	18	3.7	0°	-7°	0.8	DC**11T3...	3
A25S-SDQCR/L11-D300	Steel	30	25	16.2	250	45	23	3.7	0°	-4°	0.8	DC**11T3...	3
E10H-SDQCR07-D130	Carbide	13	10	7.6	100	25	9	2.5	0°	-8°	0.4	DC**0702...	1.2
E10M-SDQCR/L07-D130	Carbide	13	10	7.6	150	25	9	2.6	0°	-8°	0.4	DC**0702...	1.2
E12J-SDQCR07-D160	Carbide	16	12	8.6	110	27	11	2.5	0°	-6°	0.4	DC**0702...	1.2
E12Q-SDQCR/L07-D160	Carbide	16	12	8.6	180	27	11	2.6	0°	-6°	0.4	DC**0702...	1.2
E16L-SDQCR07-D200	Carbide	20	16	10.6	130	32	15	2.5	0°	-5°	0.4	DC**0702...	1.2
E16R-SDQCR/L07-D200	Carbide	20	16	10.6	200	32	15	2.6	0°	-5°	0.4	DC**0702...	1.2
E20S-SDQCR/L11-D250	Carbide	25	20	13.7	250	36	18	3.7	0°	-7°	0.8	DC**11T3...	3

*Torque: Recommended clamping torque (N-m)

**RE : Standard corner radius

Note: Use right-hand toolholders (SDQCR**) with left-hand inserts (L); and left-hand toolholders (SDQCL**) with right-hand inserts (R).

SPARE PARTS

Designation	Clamping screw	Wrench
A1**-SDQCR/L07-D**0	CSTB-2.5S	T-8F
A2**-SDQCR/L11-D**0	CSTB-4S	T-15F
E1**-SDQCR/L07-D**0	CSTB-2.5S	T-8F
E20S-SDQCR/L11-D250	CSTB-4S	T-15F

INSERT SELECTION

P	Application	Precision finishing	Finishing		Finishing to medium cutting
	Grade	SH725	SH725	NS9530	T9215
	Breaker Shape	JP	JS	PSS	PS
	Cutting conditions	B016			
P	Application	Medium cutting			
	Grade	T9215			
	Breaker Shape	PM			
	Cutting conditions	B016			
K	Application	Finishing to medium cutting			
	Grade	T515			
	Breaker Shape	CM			
	Cutting conditions	B020			
S	Application	Precision finishing	Finishing	Finishing to medium cutting	
	Grade	BX470	AH8005	AH8015	
	Breaker Shape	CBN	PS	PS	
	Cutting conditions	B024			
M	Application	Precision finishing	Finishing		Finishing to medium cutting
	Grade	SH725	SH725	AH6225	AH6225
	Breaker Shape	JP	JS	PSS	PS
	Cutting conditions	B018			
M	Application	Medium cutting			
	Grade	AH6225			
	Breaker Shape	PM			
	Cutting conditions	B018			
N	Application	Precision finishing	Finishing	Finishing to medium cutting	
	Grade	DX120	DX140	KS05F	
	Breaker Shape	DIA	with rake	AL	
	Cutting conditions	B022			
H	Application	Precision finishing	Finishing		
	Grade	BXA10	BXA20		
	Breaker Shape	HP	HS		
	Cutting conditions	B026			

Reference pages: A/E-SDQCR/L: Insert → **B121**, CBN → **B193 -**, PCD → **B214**

T-SDQCR/L

Screw-on boring bar, for positive 55° rhombic inserts (Tsuppari-Ichiban)

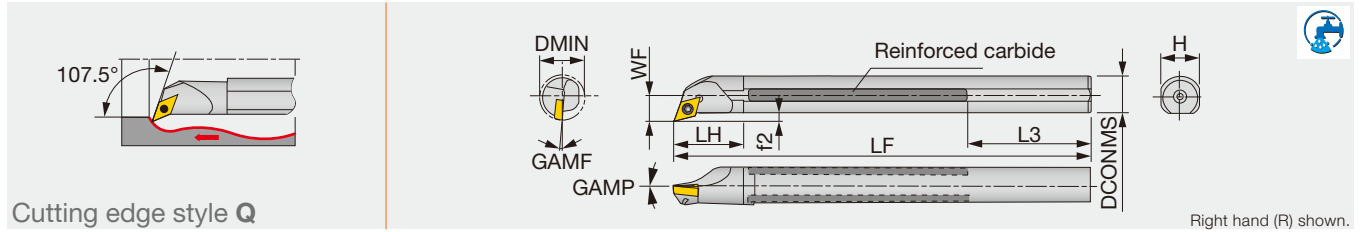

Designation	Material	DMIN	CNT	DCONMS	WF	LF	LH	L3	H	f2	GAMP	GAMF	RE**	Insert	Torque*
T16Q-SDQCR/L07	Reinforced	20	-	16	11	180	27	59	15	3	0°	-6°	0.4	DC**0702...	1.2
T20R-SDQCR/L11C	Reinforced	25	Rc1/4	20	13	200	35	49	18	3	0°	-6°	0.8	DC**11T3...	3
T25S-SDQCR/L11C	Reinforced	32	Rc1/4	25	17	250	40	64	23	4.5	0°	-4°	0.8	DC**11T3...	3

*Torque: Recommended clamping torque (N·m)

**RE : Standard corner radius

*The hole specification of applicable inserts conforms to ISO standard.

Note: Use right-hand toolholders (SDQCR**) with left-hand inserts (L); and left-hand toolholders (SDQCL**) with right-hand inserts (R).

SPARE PARTS

Designation	Clamping screw	Wrench
T16Q-SDQCR/L07	CSTB-2.5	T-8F
T20R-SDQCR/L11C	CSTB-4M	T-15F
T25S-SDQCR/L11C	CSTB-4	T-15F

INSERT SELECTION

P	Application	Precision finishing	Finishing		Finishing to medium cutting
	Grade	SH725	SH725	NS9530	T9215
	Breaker Shape				
	Cutting conditions	B016			
M	Application	Precision finishing	Finishing		Finishing to medium cutting
	Grade	SH725	SH725	AH6225	AH6225
	Breaker Shape				
	Cutting conditions	B018			
P	Application	Medium cutting			
	Grade	T9215			
	Breaker Shape				
	Cutting conditions	B016			
M	Application	Medium cutting			
	Grade	AH6225			
	Breaker Shape				
	Cutting conditions	B018			
K	Application	Finishing to medium cutting			
	Grade	T515			
	Breaker Shape				
	Cutting conditions	B020			
N	Application	Precision finishing	Finishing	Finishing to medium cutting	
	Grade	DX120	DX140	KS05F	
	Breaker Shape				
	Cutting conditions	B022			
S	Application	Precision finishing	Finishing	Finishing to medium cutting	
	Grade	BX470	AH8005	AH8015	
	Breaker Shape				
	Cutting conditions	B024			
H	Application	Precision finishing	Finishing		
	Grade	BXA10	BXA20		
	Breaker Shape				
	Cutting conditions	B026			

Reference pages: T-SDQCR/L: Insert → **B121**, CBN → **B193 -**, PCD → **B214**



STREAMJETBAR

A/E-SDQPR/L

Screw-on boring bar, for positive 55° rhombic inserts

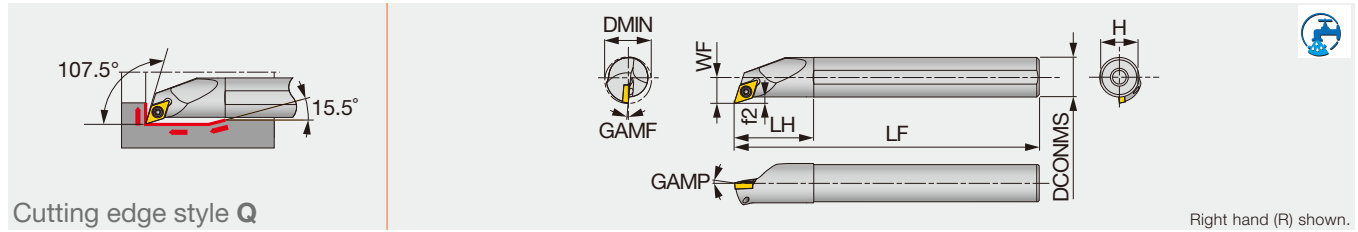

Designation	Material	DMIN	DCONMS	WF	LF	LH	H	f2	GAMP	GAMF	RE**	Insert	Torque*
A12M-SDQPR07-D150-P	Special alloy steel	15	12	8.3	150	24	11	2.3	5	0	0.40	DPMT0702...	1.2
A12M-SDQPL07-D150-P	Special alloy steel	15	12	8.3	150	24	11	2.3	5	0	0.40	DPMT0702...	1.2
A12M-SDQPR07-D180-P	Special alloy steel	18	12	9.6	150	24	11	3.6	5	0	0.40	DPMT0702...	1.2
A12M-SDQPL07-D180-P	Special alloy steel	18	12	9.6	150	24	11	3.6	5	0	0.40	DPMT0702...	1.2
A16Q-SDQPR07-D220-P	Special alloy steel	22	16	11.6	180	32	15	3.6	5	0	0.40	DPMT0702...	1.2
A16Q-SDQPL07-D220-P	Special alloy steel	22	16	11.6	180	32	15	3.6	5	0	0.40	DPMT0702...	1.2
E12Q-SDQPR07-D150	Carbide	15	12	8.3	180	27	11	2.3	5	0	0.40	DPMT0702...	1.2
E12Q-SDQPL07-D150	Carbide	15	12	8.3	180	27	11	2.3	5	0	0.40	DPMT0702...	1.2
E12Q-SDQPR07-D180	Carbide	18	12	9.6	180	27	11	3.6	5	0	0.40	DPMT0702...	1.2
E12Q-SDQPL07-D180	Carbide	18	12	9.6	180	27	11	3.6	5	0	0.40	DPMT0702...	1.2
E16R-SDQPR07-D220	Carbide	22	16	11.6	200	32	15	3.6	5	0	0.40	DPMT0702...	1.2
E16R-SDQPL07-D220	Carbide	22	16	11.6	200	32	15	3.6	5	0	0.40	DPMT0702...	1.2

*Torque: Recommended clamping torque (N-m)

**RE : Standard corner radius

Note: Use right-hand toolholders (SDQCR**) with left-hand inserts (L); and left-hand toolholders (SDQCL**) with right-hand inserts (R).

SPARE PARTS

Designation	Clamping screw	Wrench
A**-SDQPR/L07-D**0-P	CSTB-2.5S	T-8F
E**-SDQPR/L07-D**0	CSTB-2.5S	T-8F

INSERT SELECTION

Application	Finishing	Finishing to medium cutting
	Grade	NS9530
Breaker Shape	PS	PS
Cutting conditions	B016	

Application	Finishing	Finishing to medium cutting
	Grade	AH6225
Chipbreaker shape	PS	PS
Cutting conditions	B018	

Application	Finishing	Finishing to medium cutting
	Grade	NS9530
Breaker Shape	PS	PS
Cutting conditions	B020	

Application	Finishing	Finishing to medium cutting
	Grade	AH8015
Breaker Shape	PS	PS
Cutting conditions	B024	

Reference pages: A/E-SDQPR/L: Insert → **B126**

STREAMJETBAR

A/E-SVQBR/L

Screw-on boring bar, for positive 35° rhombic inserts

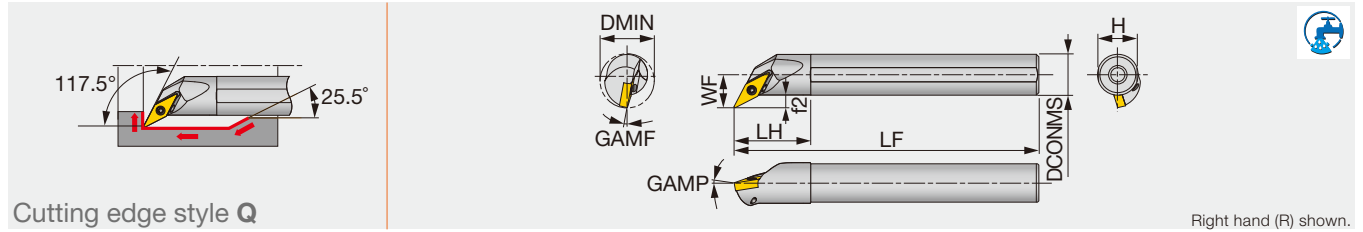

Cutting edge style Q

Right hand (R) shown.

Designation	Material	DMIN	DCONMS	WF	LF	LH	H	f2	GAMP	GAMF	RE**	Insert	Torque*
A12M-SVQBR/L11-D170	Steel	17	12	10.5	150	24	11	4.5	-5°	-10°	0.4	VB**1103...	1.2
A16Q-SVQBR/L11-D215	Steel	21.5	16	13	180	30	15	5	-5°	-8°	0.4	VB**1103...	1.2
A20R-SVQBR/L11-D255	Steel	25.5	20	15	200	36	18	5	-5°	-6°	0.4	VB**1103...	1.2
A25S-SVQBR/L16-D305	Steel	30.5	25	17.5	250	45	23	5	-5°	-8°	0.8	VB**1604...	3
E12Q-SVQBR/L11-D170	Carbide	17	12	10.5	180	27	11	4.5	-5°	-10°	0.4	VB**1103...	1.2
E16R-SVQBR/L11-D215	Carbide	21.5	16	13	200	32	15	5	-5°	-8°	0.4	VB**1103...	1.2
E20S-SVQBR/L11-D255	Carbide	25.5	20	15	250	36	18	5	-5°	-6°	0.4	VB**1103...	1.2
E25T-SVQBR/L16-D305	Carbide	30.5	25	17.5	300	45	23	5	-5°	-8°	0.8	VB**1604...	3

*Torque: Recommended clamping torque (N·m)

**RE : Standard corner radius

Note: Use right-hand toolholders (SVQBR**) with left-hand inserts (L); and left-hand toolholders (SVQBL**) with right-hand inserts (R).

SPARE PARTS

Designation	Clamping screw	Wrench
A**-SVQBR/L11-D...	CSTB-2.5	T-8F
A25S-SVQBR/L16-D305	CSTB-3.5	T-15F
E**-SVQBR/L11-D...	CSTB-2.5	T-8F
E25T-SVQBR/L16-D305	CSTB-3.5	T-15F

INSERT SELECTION

P	Application	Precision finishing	Finishing		Finishing to medium cutting	M	Application	Precision finishing	Finishing		Finishing to medium cutting	
	Grade	SH725	SH725	NS9530	T9215		Grade	SH725	SH725	AH6225	AH6225	
	Breaker Shape	JP	JS	PSS	PS		Chipbreaker shape	JP	JS	PSS	PS	
	Cutting conditions	B014						Cutting conditions	B016			
P	Application	Medium cutting	S	Application	Finishing	Finishing to medium cutting	M	Application	Medium cutting			
	Grade	T9215		Grade	AH8005	AH8015		Grade	AH6225			
	Breaker Shape	PS		Breaker Shape	PS	PS		Chipbreaker shape	PS			
	Cutting conditions	B014		Cutting conditions	B024			Cutting conditions	B016			
K	Application	Finishing to medium cutting	H	Application	Precision finishing	Finishing	M	Application	Precision finishing	Finishing		
	Grade	T515		Grade	BXA10	BXA20		Grade	BXA10	BXA20		
	Breaker Shape	CM		Breaker Shape	HP	HS		Breaker Shape	HP	HS		
	Cutting conditions	B020		Cutting conditions	B026			Cutting conditions	B026			

Reference pages: A/E-SVQBR/L: Insert → B150 -, CBN → B207 -



T-SVQBR

Screw-on boring bar, for positive 35° rhombic inserts (Tsuppari-Ichiban)

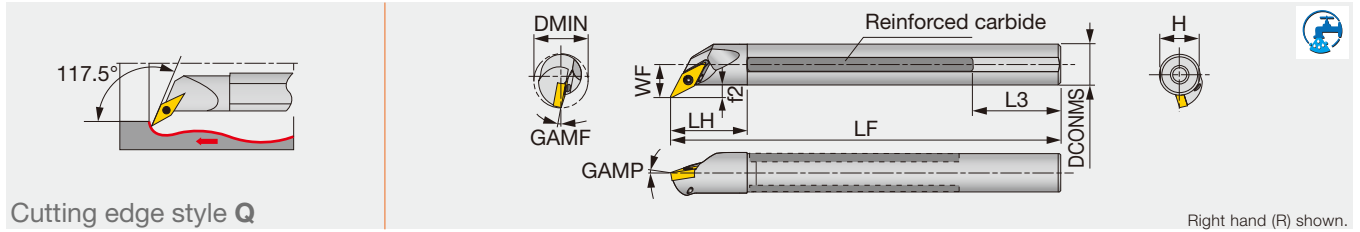

Designation	Material	DMIN	CNT	DCONMS	WF	LF	LH	L3	H	f2	GAMP	GAMF	RE**	Insert	Torque*
T20R-SVQBR11C	Reinforced	25	Rc1/4	20	14	200	30	59	18	4	-5°	-7°	0.4	VB**1103...	1.2

*Torque: Recommended clamping torque (N·m)

**RE : Standard corner radius

*The hole specification of applicable inserts conforms to ISO standard.

Note: Use right-hand toolholders (R) with left-hand inserts (L); and left-hand toolholders (L) with right-hand inserts (R).

SPARE PARTS

Designation	Clamping screw	Wrench
T20R-SVQBR11C	CSTB-2.5	T-8F

INSERT SELECTION

Application	Precision finishing		Finishing		Finishing to medium cutting
	SH725	SH725	NS9530	T9215	T9215
Grade	JP	JS	PSS	PS	PS
Breaker Shape					
Cutting conditions	B014				

Application	Precision finishing	Finishing		Finishing to medium cutting
	SH725	SH725	AH6225	AH6225
Grade	JP	JS	PSS	PS
Chipbreaker shape				
Cutting conditions	B016			

Application	Medium cutting
Grade	T9215
Breaker Shape	
Cutting conditions	B014

Application	Medium cutting
Grade	AH6225
Chipbreaker shape	
Cutting conditions	B016

Application	Finishing to medium cutting	Application	Finishing	Finishing to medium cutting
	T515		AH8005	AH8015
Grade	CM	Grade	PS	PS
Breaker Shape		Breaker Shape		
Cutting conditions	B020	Cutting conditions	B024	

Application	Precision finishing	Finishing
	Grade	BXA10
Breaker Shape	HP	HS
Cutting conditions	B026	

Reference pages: T-SVQBR: Insert → B150 -, CBN → B207 -

STREAMJETBAR

A/E-SVQCR/L

Screw-on boring bar, for positive 35° rhombic inserts

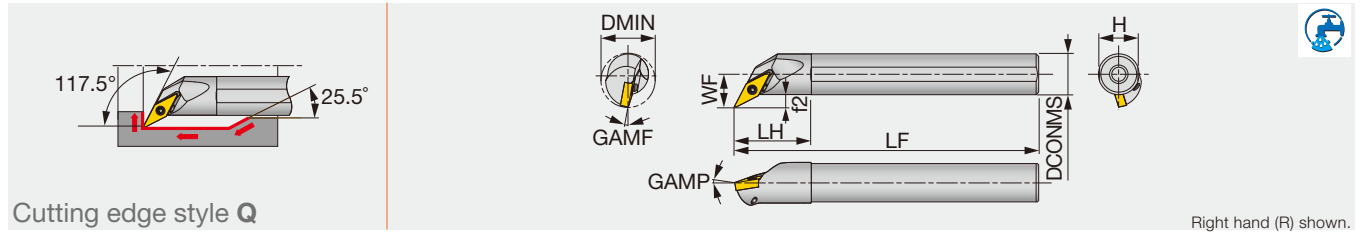

Cutting edge style Q

Right hand (R) shown.

Designation	Material	DMIN	DCONMS	WF	LF	LH	H	f2	GAMP	GAMF	RE**	Insert	Torque*
A10K-SVQCR/L08-D135	Steel	13.5	10	8	125	20	9	3	-5°	-8°	0.4	VC**0802...	0.6
A16Q-SVQCR/L11-D215	Steel	21.5	16	13	180	30	15	4.9	-5°	-8°	0.4	VC**1103...	1.2
E10M-SVQCR/L08-D135	Carbide	13.5	10	8	150	25	9	3	-5°	-8°	0.4	VC**0802...	0.6
E16R-SVQCR/L11-D215	Carbide	21.5	16	13	200	32	15	4.9	-5°	-8°	0.4	VC**1103...	1.2

*Torque: Recommended clamping torque (N-m)

**RE : Standard corner radius

Note: Use right-hand toolholders (SVQCR**) with left-hand inserts (L); and left-hand toolholders (SVQCL**) with right-hand inserts (R).

SPARE PARTS

Designation	Clamping screw	Wrench
A10K-SVQCR/L08-D135	CSTB-2L	T-6F
A16Q-SVQCR/L11-D215	CSTB-2.5	T-8F
E10M-SVQCR/L08-D135	CSTB-2L	T-6F
E16R-SVQCR/L11-D215	CSTB-2.5	T-8F

INSERT SELECTION

Application	Finishing	Finishing to medium cutting
	Grade	NS9530
Breaker Shape	PSS	PS
Cutting conditions	B016	

Application	Finishing	Finishing to medium cutting
	Grade	AH6225
Chipbreaker shape	PSS	PS
Cutting conditions	B018	

Application	Finishing to medium cutting
	Grade
Breaker Shape	CM
Cutting conditions	B020

Application	Precision finishing	Finishing	Medium cutting
	Grade	DX120	DX140
Breaker Shape	DIA	with rake DIA	AL
Cutting conditions	B022		

Application	Finishing	Finishing to medium cutting
	Grade	AH8005
Breaker Shape	PS	PS
Cutting conditions	B024	

Application	Precision finishing	Finishing
	Grade	BXA10
Breaker Shape	CBN	CBN
Cutting conditions	B026	

Reference pages: A/E-SVQCR/L: Insert → B152 -, CBN → B209, PCD → B220



T-SVQCR

Screw-on boring bar, for positive 35° rhombic inserts (Tsuppari-Ichiban)

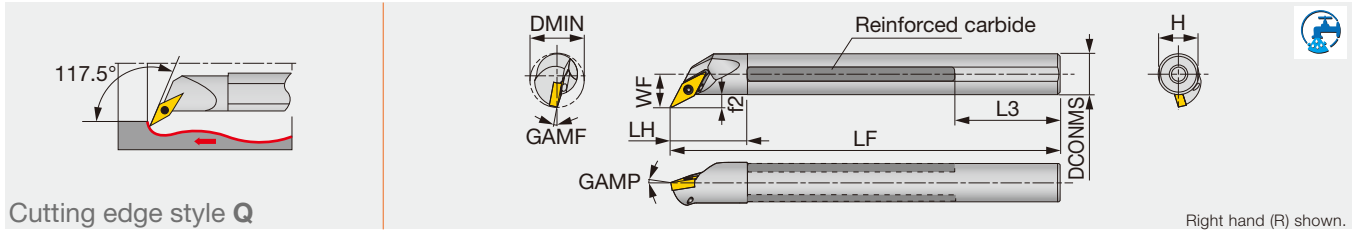

Designation	Material	DMIN	CNT	DCONMS	WF	LF	LH	L3	H	f2	GAMP	GAMF	RE**	Insert	Torque*
T25S-SVQCR16C	Reinforced	32	Rc1/4	25	17	250	40	64	23	4.5	0°	-5°	0.8	VC**1604...	3

*Torque: Recommended clamping torque (N-m)

**RE : Standard corner radius

*The hole specification of applicable inserts conforms to ISO standard.

Note: Use right-hand toolholders (R) with left-hand inserts (L); and left-hand toolholders (L) with right-hand inserts (R).

SPARE PARTS

Designation	Clamping screw	Wrench
T25S-SVQCR16C	CSTB-3.5L	T-15F

INSERT SELECTION

P

Application	Finishing	Finishing to medium cutting
Grade	NS9530	T9215
Breaker Shape	PSS	PS
Images		
Cutting conditions	B016	

M

Application	Finishing	Finishing to medium cutting
Grade	AH6225	AH6225
Breaker Shape	PSS	PS
Images		
Cutting conditions	B018	

K

Application	Finishing to medium cutting
Grade	T515
Breaker Shape	CM
Image	
Cutting conditions	B020

N

Application	Precision finishing	Finishing	Medium cutting
Grade	DX120	DX140	KS05F
Breaker Shape	DIA	with rake DIA	AL
Images			
Cutting conditions	B022		

S

Application	Finishing	Finishing to medium cutting
Grade	AH8005	AH8015
Breaker Shape	PS	PS
Images		
Cutting conditions	B024	

H

Application	Precision finishing	Finishing
Grade	BXA10	BXA20
Breaker Shape	CBN	CBN
Images		
Cutting conditions	B026	

Reference pages: T-SVQCR: Insert → **B152 -**, CBN → **B209**, PCD → **B220**

Y-PRO SERIES

A/E-SYQBR/L

Screw-on boring bar, for positive 25° rhombic inserts

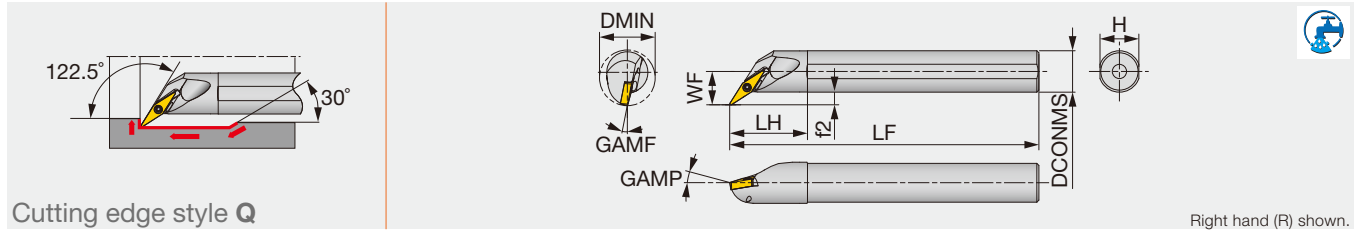

Designation	Material	DMIN	DCONMS	WF	LF	LH	H	f2	GAMP	GAMF	RE**	Insert	Torque*
A12M-SYQBR/L11-D170	Steel	17	12	10.5	150	24	11	4.5	-5°	-10°	0.4	YW**11T2...	0.6
A16Q-SYQBR/L11-D215	Steel	21.5	16	13	180	30	15	5	-5°	-8°	0.4	YW**11T2...	0.6
E12Q-SYQBR/L11-D170	Carbide	17	12	10.5	180	27	11	4.5	-5°	-10°	0.4	YW**11T2...	0.6
E16R-SYQBR/L11-D215	Carbide	21.5	16	13	200	32	15	5	-5°	-8°	0.4	YW**11T2...	0.6

*Torque: Recommended clamping torque (N-m)

**RE : Standard corner radius

SPARE PARTS

Designation	Clamping screw	Wrench
A**-SYQBR/L11-D...	CSTB-2L	T-6F
E**-SYQBR/L11-D...	CSTB-2L	T-6F

INSERT SELECTION

Application	Finishing	Finishing to medium cutting	Medium cutting
	Grade	GT9215	T9215
Breaker Shape	ZF	ZF	ZM
Cutting conditions	B016		

Application	Finishing	Finishing to medium cutting	Medium cutting
	Grade	AH8015	AH8015
Breaker Shape	ZF	ZF	ZM
Cutting conditions	B018		

Application	Finishing	Finishing to medium cutting	Medium cutting
	Grade	GT9530	T9215
Breaker Shape	ZF	ZF	ZM
Cutting conditions	B020		

Application	Finishing	Finishing to medium cutting	Medium cutting
	Grade	AH8015	AH8015
Breaker Shape	ZF	ZF	ZM
Cutting conditions	B024		

Reference pages: A/E-SYQBR/L: Insert → **B159**



STREAMJETBAR

A/E-SEZPR/L

Screw-on boring bar, for positive 75° rhombic inserts

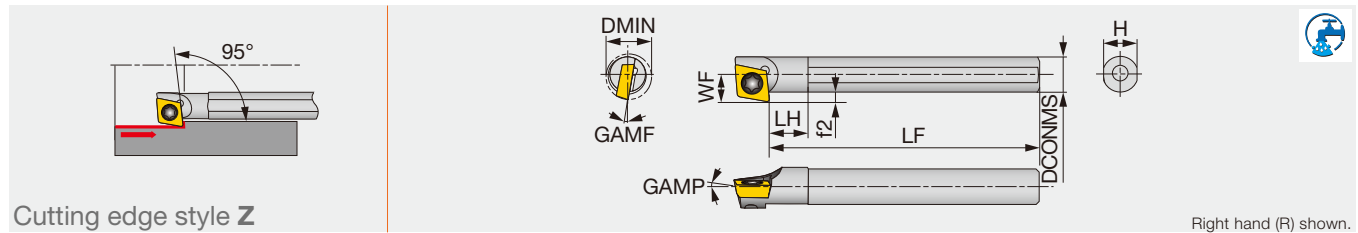

Designation	Material	DMIN	DCONMS	WF	LF	LH	H	f2	GAMP	GAMF	RE**	Insert	Torque*
A04F-SEZPR/L03-D055	Steel	5.5	4	3.2	80	4	3.8	1.2	0°	-8°	0.2	EP**03X1...	0.6
A05F-SEZPR/L03-D065	Steel	6.5	5	3.7	80	5	4.8	1.2	0°	-6°	0.2	EP**03X1...	0.6
E04G-SEZPR/L03-D055	Carbide	5.5	4	3.2	90	5	3.8	1.2	0°	-8°	0.2	EP**03X1...	0.6
E05G-SEZPR/L03-D065	Carbide	6.5	5	3.7	90	6	4.8	1.2	0°	-6°	0.2	EP**03X1...	0.6

*Torque: Recommended clamping torque (N-m)

**RE : Standard corner radius

Note: Use right-hand toolholders (SEZPR**) with right-hand inserts (R); and left-hand toolholders (SEZPL**) with left-hand inserts (L).

SPARE PARTS

Designation	Clamping screw	Wrench
A**-SEZPR/L03-D...	CSTA-1.6	T-6F
E**-SEZPR/L03-D...	CSTA-1.6	T-6F

INSERT SELECTION

P	Application	Finishing	M	Application	Finishing	K	Application	Finishing	S	Application	Finishing
	Grade	SH725		Grade	SH725		Grade	SH725		Grade	SH725
	JS			JS			JS			JS	
	Breaker Shape			Breaker Shape			Breaker Shape			Breaker Shape	
	Cutting conditions	B016		Cutting conditions	B018		Cutting conditions	B020		Cutting conditions	B024
N	Application	Precision finishing	Finishing	H	Application	Precision finishing					
	Grade	DX140	SH725		Grade	BX310					
	DIA		JS		CBN						
	Breaker Shape			Breaker Shape							
	Cutting conditions	B022		Cutting conditions	B026						

Reference pages: A/E-SEZPR/L: Insert → **B128** -, CBN → **B195**, PCD → **B214**

STREAMJETBAR

A/E-SDZCR/L

Screw-on boring bar, for positive 55° rhombic inserts

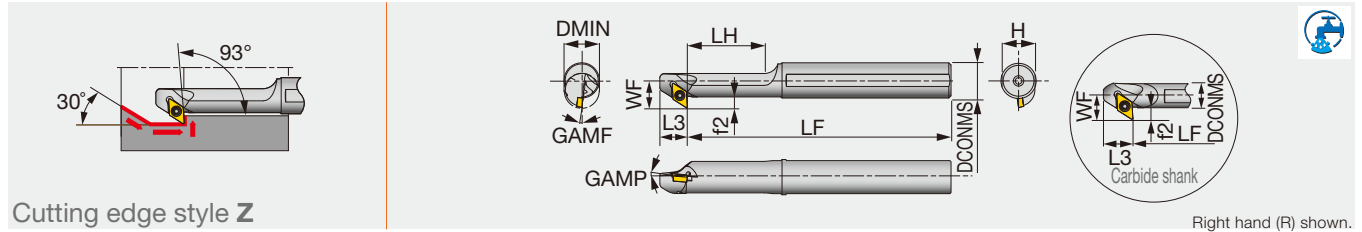

Designation	Material	DMIN	DCONMS	WF	LF	LH	L3	H	f2	GAMP	GAMF	RE**	Insert	Torque*
A12M-SDZCR/L07-D140	Steel	14	12	10.5	150	30	12.5	11	4.5	0°	-9°	0.4	DC**0702...	1.2
A16Q-SDZCR/L07-D160	Steel	16	16	12.5	180	35	12.5	15	4.5	0°	-8°	0.4	DC**0702...	1.2
A20R-SDZCR/L11-D200	Steel	20	20	15.5	200	40	15.0	18	5.5	0°	-8°	0.8	DC**11T3...	3
A25S-SDZCR/L11-D250	Steel	25	25	18	250	50	15	23	5.5	0°	-6°	0.8	DC**11T3...	3
E12Q-SDZCR/L07-D180	Carbide	18	12	10.5	180	-	12.5	11	4.5	0°	-8°	0.4	DC**0702...	1.2
E16R-SDZCR/L07-D220	Carbide	22	16	12.5	200	-	12.5	15	4.5	0°	-6°	0.4	DC**0702...	1.2

*Torque: Recommended clamping torque (N-m)

**RE : Standard corner radius

Note: Use right-hand toolholders (SDZCR**) with right-hand inserts (R); and left-hand toolholders (SDZCL**) with left-hand inserts (L).

SPARE PARTS

Designation	Clamping screw	Wrench
A1**-SDZCR/L07-D1*0	CSTB-2.5	T-8F
A2**-SDZCR/L11-D2*0	CSTB-4S	T-15F
E1**-SDZCR/L07-D**0	CSTB-2.5	T-8F

INSERT SELECTION

P	Application	Precision finishing	Finishing		Finishing to medium cutting
	Grade	SH725	SH725	NS9530	T9215
	Breaker Shape	JP	JS	PSS	PS
	Cutting conditions	B016			
M	Application	Precision finishing	Finishing		Finishing to medium cutting
	Grade	SH725	SH725	AH6225	AH6225
	Breaker Shape	JP	JS	PSS	PS
	Cutting conditions	B018			
P	Application	Medium cutting			
	Grade	T9215			
	Breaker Shape	PM			
	Cutting conditions	B016			
M	Application	Medium cutting			
	Grade	AH6225			
	Breaker Shape	PM			
	Cutting conditions	B018			
K	Application	Finishing to medium cutting			
	Grade	T515			
	Breaker Shape	CM			
	Cutting conditions	B020			
S	Application	Precision finishing	Finishing	Finishing to medium cutting	
	Grade	BX470	AH8005	AH8015	
	Breaker Shape	CBN	PS	PS	
	Cutting conditions	B024			
N	Application	Precision finishing	Finishing	Finishing to medium cutting	
	Grade	DX120	DX140	KS05F	
	Breaker Shape	DIA with rake	AL	AL	
	Cutting conditions	B022			
H	Application	Precision finishing	Finishing		
	Grade	BXA10	BXA20		
	Breaker Shape	HP	HS		
	Cutting conditions	B026			

Reference pages: A/E-SDZCR/L: Insert → B121, CBN → B193 -, PCD → B214



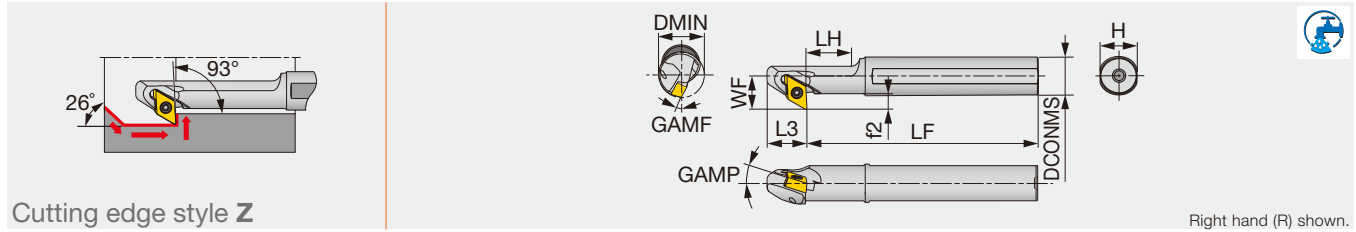

Designation	Material	DMIN	DCONMS	WF	LF	LH	L3	H	f2	GAMP	GAMF	RE**	Insert	Torque*
A12M-SDZXR/L07-D140	Steel	14	12	10.5	150	30	13	11	4.5	-10°	-14°	0.4	DXG/MU0703**R/L...	0.9
A16Q-SDZXR/L07-D160	Steel	16	16	12.5	180	35	13	15	4.5	-10°	-12.5°	0.4	DXG/MU0703**R/L...	0.9
A20R-SDZXR/L07-D200	Steel	20	20	14.5	200	40	13	18	4.5	-10°	-10.5°	0.4	DXG/MU0703**R/L...	0.9
E12Q-SDZXR/L07-D180	Carbide	18	12	10.5	180	-	13	11	4.5	-11°	-11°	0.4	DXG/MU0703**R/L...	0.9
E16R-SDZXR/L07-D220	Carbide	22	16	12.5	200	-	13	15	4.5	-11°	-9°	0.4	DXG/MU0703**R/L...	0.9

*Torque: Recommended clamping torque (N-m) **RE : Standard corner radius
 Note: Use right-hand toolholders (R) with right-hand inserts (R); and left-hand toolholders (L) with left-hand inserts (L).

SPARE PARTS

Designation	Clamping screw	Wrench
A/E**-SDZXR/L...	SR34-514	T-7F

INSERT SELECTION

P	Application	Precision finishing	Finishing		Finishing to medium cutting
	Grade	SH725	SH725	NS9530	T9215
	Breaker Shape	JS	JTS	SS	TS
	Chipbreaker shape				
	Cutting conditions	D096			

M	Application	Precision finishing	Finishing		Finishing to medium cutting
	Grade	SH725	SH725	AH8015	AH8015
	Breaker Shape	JS	JTS	SS	TS
	Chipbreaker shape				
	Cutting conditions	D096			

P	Application	Medium cutting
	Grade	T9215
	Breaker Shape	TS
	Chipbreaker shape	
	Cutting conditions	D096

M	Application	Medium cutting
	Grade	AH8015
	Breaker Shape	TS
	Chipbreaker shape	
	Cutting conditions	D096

K	Application	Precision finishing	Finishing		Finishing to medium cutting
	Grade	SH725	SH725	NS9530	T9215
	Breaker Shape	JS	JTS	SS	TS
	Chipbreaker shape				
	Cutting conditions	D096			

N	Application	Finishing	Finishing to medium cutting	Medium cutting
	Grade	KS05F	KS05F	KS05F
	Breaker Shape	SS	TS	TS
	Chipbreaker shape			
	Cutting conditions	D096		

K	Application	Medium cutting
	Grade	T9215
	Breaker Shape	TS
	Chipbreaker shape	
	Cutting conditions	D096

S	Application	Precision finishing	Finishing		Finishing to medium cutting
	Grade	SH725	SH725	AH8015	AH8015
	Breaker Shape	JS	JTS	SS	TS
	Chipbreaker shape				
	Cutting conditions	D096			

S	Application	Medium cutting
	Grade	AH8015
	Breaker Shape	TS
	Chipbreaker shape	
	Cutting conditions	D096

Reference pages: A/E-SDZXR/L: Insert → **B126** -
 Standard cutting conditions → **D096**

STREAMJETBAR

A-SVZBR/L

Screw-on boring bar, for positive 35° rhombic inserts

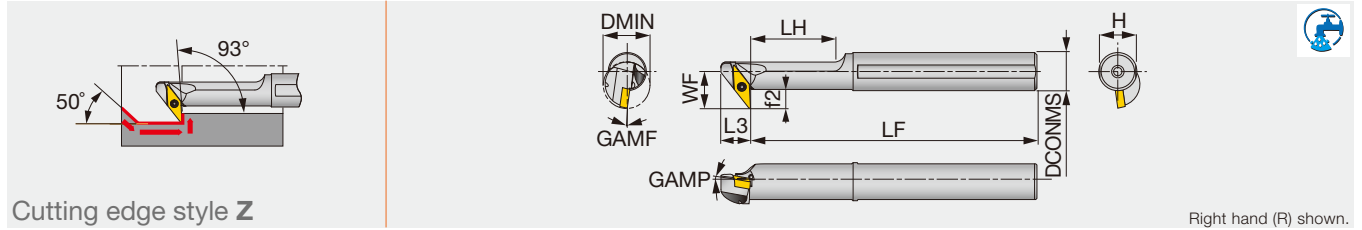

Cutting edge style Z

Right hand (R) shown.

Designation	Material	DMIN	DCONMS	WF	LF	LH	L3	H	f2	GAMP	GAMF	RE**	Insert	Torque*
A16Q-SVZBR/L11-D200	Steel	20	16	15.5	180	35	12.5	15	8	0°	-8°	0.4	VB**1103...	1.2
A20R-SVZBR/L11-D250	Steel	25	20	17.5	200	40	12.5	18	8	0°	-7°	0.4	VB**1103...	1.2
A25S-SVZBR/L16-D320	Steel	32	25	24	250	50	17.5	23	12	0°	-6°	0.8	VB**1604...	3
A32T-SVZBR/L16-D400	Steel	40	32	27.5	300	72	17.5	30	12	0°	-5°	0.8	VB**1604...	3

*Torque: Recommended clamping torque (N-m)

**RE : Standard corner radius

Note: Use right-hand toolholders (SVZBR**) with right-hand inserts (R); and left-hand toolholders (SVZBL**) with left-hand inserts (L).

SPARE PARTS

Designation	Clamping screw	Wrench
A**-SVZBR/L11-D2*0	CSTB-2.5	T-8F
A25S-SVZBR/L16-D320	CSTB-3.5	T-15F
A32T-SVZBR/L16-D400	CSTB-3.5L	T-15F

INSERT SELECTION

P	Application	Precision finishing	Finishing		Finishing to medium cutting	M	Application	Precision finishing	Finishing		Finishing to medium cutting
	Grade	SH725	SH725	NS9530	T9215		Grade	SH725	SH725	AH6225	AH6225
	Breaker Shape	JP	JS	PSS	PS		Chipbreaker shape	JP	JS	PSS	PS
	Cutting conditions	B014					Cutting conditions	B016			
P	Application	Medium cutting	S	Application	Finishing	Finishing to medium cutting	M	Application	Medium cutting		
	Grade	T9215		Grade	AH8005	AH8015		Grade	AH6225		
	Breaker Shape	PS		Breaker Shape	PS	PS		Chipbreaker shape	PS		
	Cutting conditions	B014		Cutting conditions	B024			Cutting conditions	B016		
K	Application	Finishing to medium cutting	H	Application	Precision finishing	Finishing	K	Application	Precision finishing	Finishing	
	Grade	T515		Grade	BXA10	BXA20		Grade	BXA10	BXA20	
	Breaker Shape	CM		Breaker Shape	HP	HS		Breaker Shape	HP	HS	
	Cutting conditions	B020		Cutting conditions	B026			Cutting conditions	B026		

Reference pages: A-SVZBR/L: Insert → **B150 -**, CBN → **B207 -**

STREAMJETBAR

A-SVZCR/L

Screw-on boring bar, for positive 35° rhombic inserts

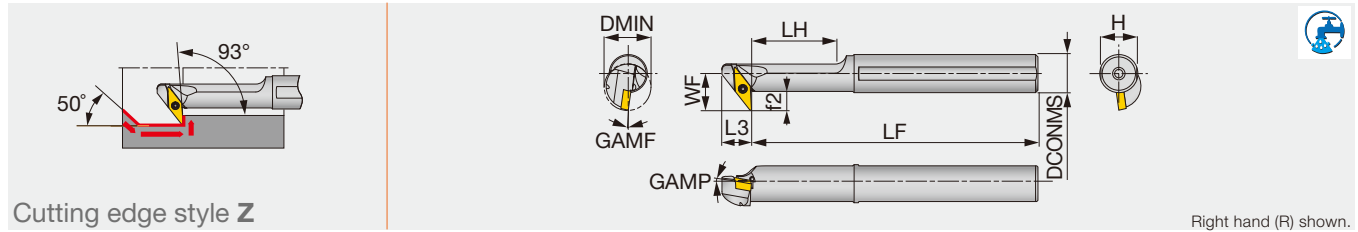

Designation	Material	DMIN	DCONMS	WF	LF	LH	L3	H	f2	GAMP	GAMF	RE**	Insert	Torque*
A12M-SVZCR/L08-D160	Steel	16	12	11	150	30	10	11	5.5	0°	-8°	0.4	VC**0802...	0.6

*Torque: Recommended clamping torque (N-m)

**RE : Standard corner radius

Note: Use right-hand toolholders (SVZCR**) with right-hand inserts (R); and left-hand toolholders (SVZCL**) with left-hand inserts (L).

SPARE PARTS

Designation	Clamping screw	Wrench
A12M-SVZCR/L08-D160	CSTB-2L	T-6F

INSERT SELECTION

P	Application	Finishing	Finishing to medium cutting	M	Application	Finishing	Finishing to medium cutting	K	Application	Finishing to medium cutting		
	Grade	NS9530	T9215		Grade	AH6225	AH6225		Grade	T515		
	Breaker Shape	PSS	PS		Chipbreaker shape	PSS	PS		Breaker Shape	CM		
	Cutting conditions	B014			Cutting conditions	B016			Cutting conditions	B020		
N	Application	Precision finishing	Finishing	Medium cutting	S	Application	Finishing	Finishing to medium cutting	H	Application	Precision finishing	Finishing
	Grade	DIA	DX120	DX140	AL	KS05F	Grade	AH8005	AH8015	Grade	BXA10	BXA20
	Breaker Shape	DIA	with rake	DIA	AL	KS05F	Breaker Shape	PS	PS	Breaker Shape	CBN	CBN
	Cutting conditions	B022				Cutting conditions	B024			Cutting conditions	B026	

A-PDZNR/L

Lever-lock boring bar, for negative 55°/45° rhombic inserts

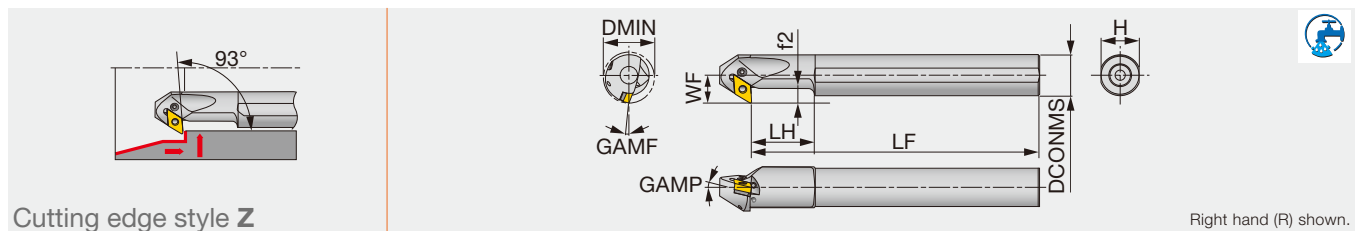

Designation	Material	DMIN	DCONMS	WF	LF	LH	H	f2	GAMP	GAMF	RE**	Insert	Torque*
A32S-PDZNR/L15-D400	Steel	40	32	22	250	50	30	11.5	-6°	-13°	0.8	DN**/FNGA1504...	4.8
A40T-PDZNR/L15-D500	Steel	50	40	27	300	60	37	14.5	-6°	-10°	0.8	DN**/FNGA1504...	4.8
A50U-PDZNR/L15-D630	Steel	63	50	35	350	65	47	14.5	-6°	-8°	0.8	DN**/FNGA1504...	4.8

*Torque: Recommended clamping torque (N-m)

**RE : Standard corner radius

Note: Use right-hand toolholders (PDZNR**) with right-hand inserts (R); and left-hand toolholders (PDZNL**) with left-hand inserts (L).

SPARE PARTS

Designation	Shim	Clamping screw	Wrench	Spring pin	Lever	Oil supply attachment*	Screw for oil hole*
A32S-PDZNR15-D400	LSZ42BR	LCS4	P-3	LSP4	LCL4	EA-32	SSHM4-5
A32S-PDZNL15-D400	LSZ42BL	LCS4	P-3	LSP4	LCL4	EA-32	SSHM4-5
A40T-PDZNR15-D500	LSZ42BR	LCS4	P-3	LSP4	LCL4	-	SSHM5-6
A40T-PDZNL15-D500	LSZ42BL	LCS4	P-3	LSP4	LCL4	-	SSHM5-6
A50U-PDZNR15-D630	LSZ42BR	LCS4	P-3	LSP4	LCL4	-	SSHM6-6
A50U-PDZNL15-D630	LSZ42BL	LCS4	P-3	LSP4	LCL4	-	SSHM6-6

*Optional

Reference pages: A-SVZCR/L: Insert → B152 -, CBN → B209, PCD → B220

A-PDZNR/L: Insert → B066 -, B075, CBN → B172 -, PCD → B211

STREAMJETBAR

S-PDZNR/L

Lever-lock boring bar, for negative 55°/45° rhombic inserts

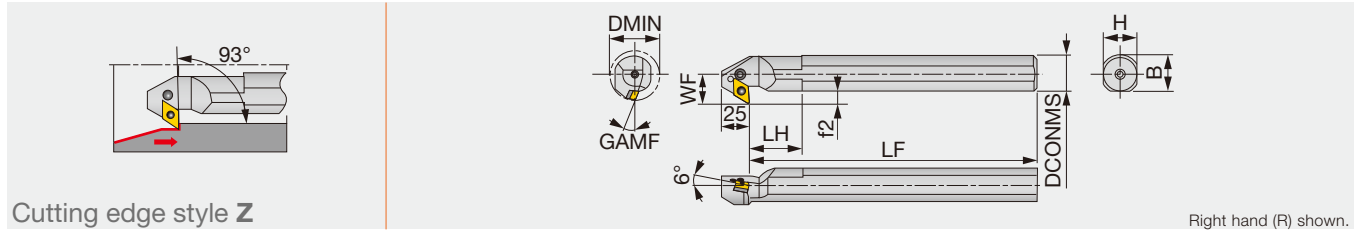

Designation	Material	DMIN	DCONMS	WF	LF	LH	H	f2	B	GAMF	RE**	Insert
S32S-PDZNR/L15	Steel	40	32	22	250	30	30	6	29.5	-13°	0.8	DN**/FNGA1504...
S40T-PDZNR15	Steel	50	40	27	300	35	37	7	37.5	-10°	0.8	DN**/FNGA1504...
S50U-PDZNR15	Steel	60	50	35	350	40	47	10	47.5	-8°	0.8	DN**/FNGA1504...

**RE : Standard corner radius

Note: Use right-hand toolholders (R) with right-hand inserts (R); and left-hand toolholders (L) with left-hand inserts (L)

SPARE PARTS

Designation	Shim	Clamping screw	Wrench	Spring pin	Lever
S32S-PDZNR15	LSZ42BR	LCS4	P-3	LSP4	LCL4
S32S-PDZNL15	LSZ42BL	LCS4	P-3	LSP4	LCL4
S*0*-PDZNR15	LSZ42BR	LCS4	P-3	LSP4	LCL4

INSERT SELECTION

P	Application	Precision finishing	Finishing	Medium cutting	Medium to heavy cutting
	Grade	NS9530	GT9530	T9215	T9215
	Breaker Shape	TF	TSF	TM	TH
	Cutting conditions	B004			
K	Application	Finishing	Medium cutting	Medium to heavy cutting	
	Grade	T515	T515	T515	
	Breaker Shape	All-round	All-round	All-round	
	Cutting conditions	B008			
S	Application	Precision finishing	Finishing	Medium cutting	
	Grade	BX470	AH8005	AH8005	
	Breaker Shape	CBN	HRF	HRM	
	Cutting conditions	B012			
M	Application	Finishing	Medium cutting	Medium to heavy cutting	
	Grade	T6215	AH6225	AH6225	
	Chipbreaker shape	SF	SM	SH	
	Cutting conditions	B006			
N	Application	Precision finishing	Finishing	Medium cutting	
	Grade	DX120	DX140	TH10	
	Breaker Shape	DIA	with rake DIA	P	
	Cutting conditions	B010			
H	Application	Precision finishing	Finishing		
	Grade	BXA10	BXA20		
	Breaker Shape	HP	HS		
	Cutting conditions	B014			

Reference pages: S-PDZNR/L: Insert → B066 -, B075, CBN → B172 -, PCD → B211



Technical Guide

BOREMEISTER

Anti-vibration bar

Anti-vibration bar for exchangeable turning heads, with through coolant

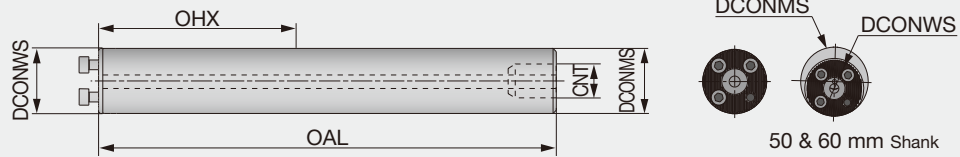

Designation	Material	DCONWS	DCONMS	OAL	OHX	CNT
D16-L156-7D-C	Steel	16	16	156.3	92	G1/8
G16-L204-10D-E	Carbide	16	16	204.3	140	-
D20-L200-7D-C	Steel	20	20	200.3	120	G1/4
G20-L260-10D-E	Carbide	20	20	260.3	180	-
D25-L255-7D-C	Steel	25	25	257.5	155	G1/4
D25-L330-10D-C	Steel	25	25	332.5	230	G1/4
D32-L320-7D-C	Steel	32	32	323	192	G3/8
D32-L416-10D-C	Steel	32	32	419	288	G3/8
D40-L408-7D-C	Steel	40	40	411	248	G1/2
D40-L528-10D-C	Steel	40	40	531	368	G1/2
D50-L518-7D-C	Steel	40	50	523	318	G1/2
D50-L668-10D-C	Steel	40	50	673	468	G1/2
D60-L628-7D-C	Steel	40	60	633	388	G3/4
D60-L808-10D-C	Steel	40	60	813	568	G3/4

SPARE PARTS

Designation	Clamping screw	Wrench
D16-L..., G16-L...	SRM3X10DIN912	HW2.5
D20-L..., G20-L...	SR55-2M3.5X10	HW2.5
D25-L...	SRM4X12DIN912	HW3.0
D32-L...	SRM5X12DIN912	HW4.0
D40-L..., D50-L..., D60-L...	SRM6X16DIN912-12.9	HW5.0

C6-9D-C

PSC adapter with anti vibration, L/D = 9

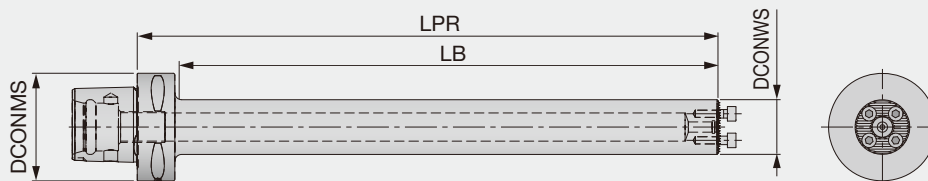

Designation	Material	DCONWS	DCONMS	LPR	LB	WT (kg)
C6-D25-L230-9D-C	Steel	25	63	230.5	200.1	1.65
C6-D32-L288-9D-C	Steel	32	63	288.5	259.5	2.73
C6-D40-L368-9D-C	Steel	40	63	368.5	339	4.45

SPARE PARTS

Designation	Clamping screw	Wrench
C6-D25...	SRM4X12DIN912	HW3.0
C6-D32...	SRM5X12DIN912	HW4.0
C6-D40...	SRM6X16DIN912-12.9	HW5.0

BOREMEISTER

C#-SH-CHP / C#-SH-E-CHP

PSC compatible adapter with steel or carbide core

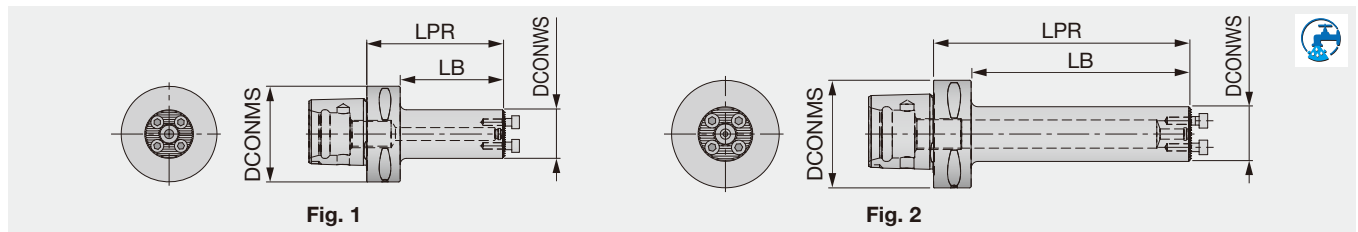

Designation	Material	DCONWS	DCONMS	LPR	LB	Fig
C4-SH-D16-2.5D-CHP	Steel	16	40	40	20	1
C4-SH-D20-2.5D-CHP	Steel	20	40	50	30	1
C4-SH-D25-2.5D-CHP	Steel	25	40	55	35	1
C4-SH-D32-2.5D-CHP	Steel	32	40	75	55	1
C4-SH-D40-3D-CHP	Steel	40	40	80	80	1
C6-SH-D20-5D-E-CHP	Carbide	20	63	100	78	2
C6-SH-D25-5D-E-CHP	Carbide	25	63	115	93	2
C6-SH-D32-5D-E-CHP	Carbide	32	63	150	128	2
C6-SH-D40-5D-E-CHP	Carbide	40	63	185	163	2

SPARE PARTS

Designation	Clamping screw	Wrench
C4**D16...	SRM3X10DIN912	HW2.5
C4/C6**D20...	SR55-2M3.5X10	HW2.5
C4/C6**D25...	SRM4X12DIN912	HW3.0
C4/C6**D32...	SRM5X12DIN912	HW4.0
C4/C6**D40...	SRM6X16DIN912-12.9	HW5.0

D#4D-SH

Steel shank for internal turning, with through coolant

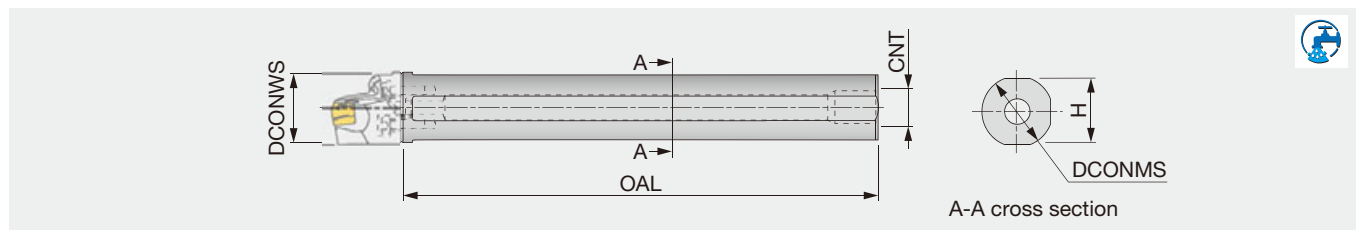

Designation	Material	DCONWS	DCONMS	OAL	CNT	H
D16-L105-4D-SH	Steel	16	16	105	UNC-2B 3/8"-16	15
D20-L140-4D-SH	Steel	20	20	140	UNFC-2B 3/8"-24	18
D25-L200-4D-SH	Steel	25	25	200	UNF-2B 1/2"-20	23
D32-L218-4D-SH	Steel	32	32	218	UNF-2B 1/2"-20	29
D40-L283-4D-SH	Steel	40	40	283	UNF-2B 1/2"-20	36

SPARE PARTS

Designation	Clamping screw	Wrench
D16**4D-SH	SRM3X10DIN912	HW2.5
D20**4D-SH	SR55-2M3.5X10	HW2.5
D25**4D-SH	SRM4X12DIN912	HW3.0
D32**4D-SH	SRM5X12DIN912	HW4.0
D40**4D-SH	SRM6X16DIN912-12.9	HW5.0

Technical Guide

BOREMEISTER

RSL sleeve

Split sleeve for anti-vibration bar

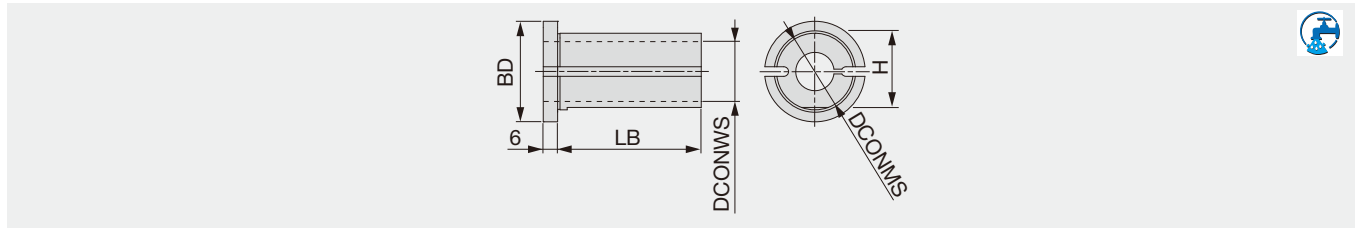

Designation	DCONWS	DCONMS	BD	LB	H
RSL-32-16-L66	16	32	42	60	31
RSL-32-20-L66	20	32	42	60	31
RSL-32-25-L66	25	32	42	60	31
RSL-40-16-L76	16	40	50	70	38.5
RSL-40-20-L76	20	40	50	70	38.5
RSL-40-25-L76	25	40	50	70	38.5

AVC-SET

Center height set up device

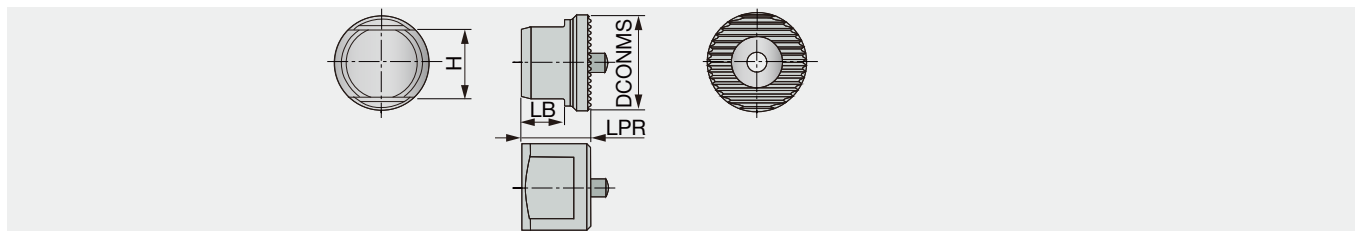

Designation	DCONMS	H	LPR	LB	Applicable shank
AVC-SET 16-25	20	15	14.5	8.9	16, 20, 25
AVC-SET 32-60	29	16	17.5	11.43	32, 40, 50, 60

STREAMJETBAR

BLM sleeve

Round shank sleeve for StreamJetBar-Mini series

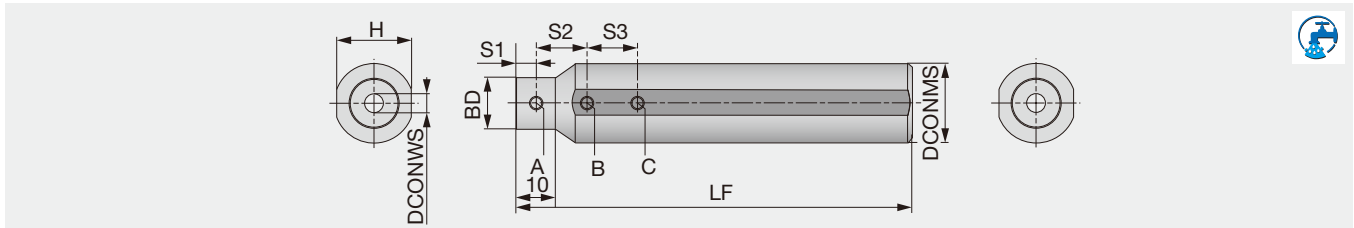

Designation	DCONMS	DCONWS	BD	LF	H	S1	S2	S3
BLM159-04	15.875	4	15	100	15	5	15	15
BLM159-05	15.875	5	15	100	15	5	15	15
BLM159-06	15.875	6	15	100	15	5	20	20
BLM159-07	15.875	7	15	100	15	5	20	20
BLM16-04	16	4	15	100	15	5	15	15
BLM16-05	16	5	15	100	15	5	15	15
BLM16-06	16	6	15	100	15	5	20	20
BLM16-07	16	7	15	100	15	5	20	20
BLM19-04	19.05	4	18	100	18	5	15	15
BLM19-05	19.05	5	18	100	18	5	15	15
BLM19-06	19.05	6	18	100	18	5	20	20
BLM19-07	19.05	7	18	100	18	5	20	20
BLM20-04	20	4	13	100	19	5	15	15
BLM20-05	20	5	14	100	19	5	15	15
BLM20-06	20	6	15	100	19	5	20	20
BLM20-07	20	7	16	100	19	5	20	20
BLM22-04	22	4	13	125	21	5	15	15
BLM22-05	22	5	14	125	21	5	15	15
BLM22-06	22	6	15	125	21	5	20	20
BLM22-07	22	7	16	125	21	5	20	20
BLM25-04	25	4	13	125	24	5	15	15
BLM25-05	25	5	14	125	24	5	15	15
BLM25-06	25	6	15	125	24	5	20	20
BLM25-07	25	7	16	125	24	5	20	20
BLM254-04	25.4	4	13	125	24	5	15	15
BLM254-05	25.4	5	14	125	24	5	15	15
BLM254-06	25.4	6	15	125	24	5	20	20
BLM254-07	25.4	7	16	125	24	5	20	20

SPARE PARTS

Designation	Clamping screw A	Clamping screw B, C	Wrench	Seal cap* (inner screw)
BLM159, 16...	SSH4-4	SSH4-4	P-2	CA-16(M6)
BLM19-04	SSH4-4	SSH4-6	P-2	CA-16(M6)
BLM19-05, 06, 07	SSH4-4	SSH4-4	P-2	CA-16(M6)
BLM20-04, 05	SSH4-4	SSH4-6	P-2	CA-16(M6)
BLM20-06, 07	SSH4-4	SSH4-4	P-2	CA-16(M6)
BLM22-...	SSH4-4	SSH4-6	P-2	CA-16(M6)
BLM25-04, 05	SSH4-4	SSH4-8	P-2	CA-16(M6)
BLM25-06	SSH4-4	SSH4-8	P-2	CA-16(M6)
BLM25-07	SSH4-4	SSH4-6	P-2	CA-16(M6)
BLM254-04, 05, 06	SSH4-4	SSH4-8	P-2	CA-16(M6)
BLM254-07	SSH4-4	SSH4-6	P-2	CA-16(M6)

*Optional

Grade

Insert

Ext. Toolholder

Int. Toolholder

Threading

Grooving

Miniature tool

Milling cutter

Endmill

Drilling tool

Tooling System

User's Guide

Index

Technical Guide

STREAMJETBAR

BLS sleeve

Square shank sleeve for boring bars (regular length)

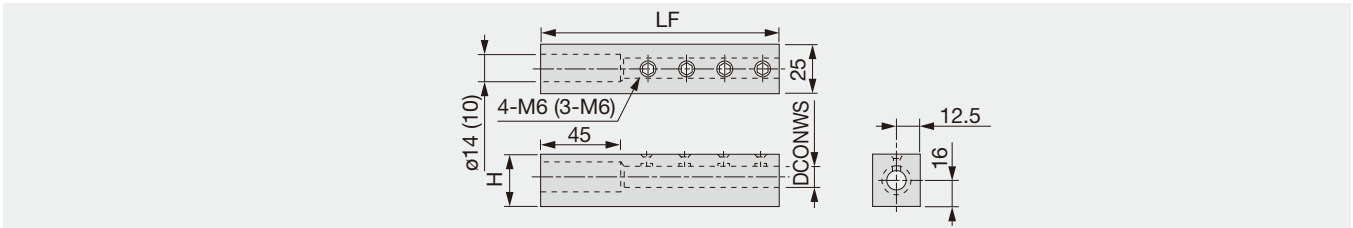

Designation	DCONWS	LF	H
BLS16-08	8	125	28
BLS16-10	10	125	28
BLS16-12	12	125	28

SPARE PARTS

Designation	Wrench
BLS16-...	P-3

BLS-C sleeve

Square shank sleeve for boring bars (short type)

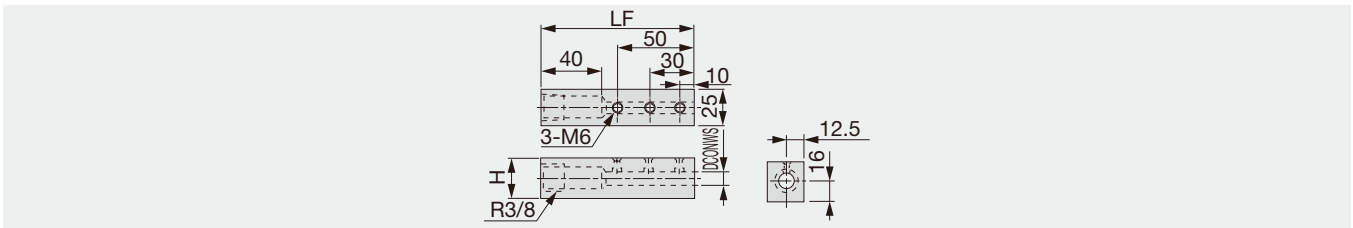

Designation	DCONWS	LF	H
BLS16-08C	8	100	28
BLS16-10C	10	100	28
BLS16-12C	12	100	28

SPARE PARTS

Designation	Wrench
BLS16-**C	P-3

STREAMJETBAR

BLM sleeve

Round shank sleeve for boring bars

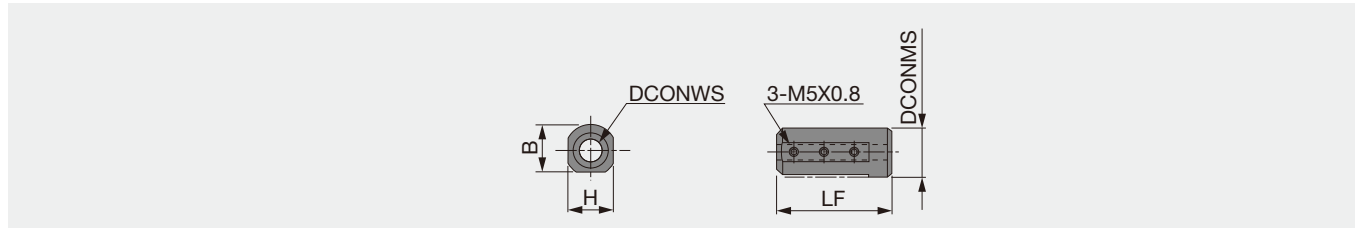

Designation	DCONWS	DCONMS	LF	H	B
BLM19-08	8	19.05	100	18	18
BLM20-08	8	20	100	18	19
BLM22-08	8	22	125	21	21
BLM254-08	8	25.4	125	24	24
BLM25-08C	8	25	55	23	24
BLM25-10C	10	25	55	23	24
BLM25-12C	12	25	55	23	24

SPARE PARTS

Designation	Wrench
BLM...	P-2.5

BLC sleeve

Round shank sleeve for boring bars

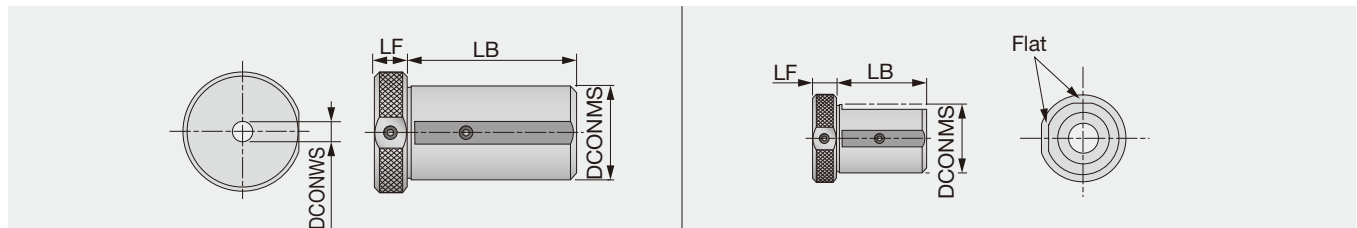

Designation	DCONWS	LB	LF	DCONMS
BLC40-8	8	73	13	40
BLC40-10	10	73	13	40
BLC40-12	12	73	13	40
BLC40-16	16	73	13	40
BLC32-8C	8	45	20	32
BLC32-10C	10	45	20	32
BLC32-12C	12	45	20	32
BLC40-8C	8	55	13	40
BLC40-10C	10	55	13	40
BLC40-12C	12	55	13	40
BLC40-16C	16	55	13	40

SPARE PARTS

Designation	Wrench
BLC40-8	P-3
BLC40-1...	P-4
BLC32-8C	P-3
BLC32-1*C	P-4
BLC40-8C	P-3
BLC40-1*C	P-4

Technical Guide

MINIFORCE TURN

STANDARD CUTTING CONDITIONS

FOR INTERNAL TURNING

ISO	Workpiece material	Grade		Cutting speed Vc (m/min)	Depth of cut ap (mm)	Feed f (mm/rev)
		First choice	Second choice			
P	Low carbon steel / Low alloy steel	T9215	-	120 - 350	0.3 - 2	0.08 - 0.3
		T9225	-	100 - 300	0.3 - 2	0.08 - 0.3
		AH8015	-	50 - 200	0.3 - 2	0.08 - 0.3
		-	AH725	50 - 180	0.3 - 2	0.08 - 0.3
		-	NS9530	80 - 250	0.3 - 2	0.08 - 0.3
		-	GT9530	80 - 300	0.3 - 2	0.08 - 0.3
	Carbon steel / Alloy steel	T9215	-	80 - 350	0.3 - 2	0.08 - 0.3
		T9225	-	80 - 300	0.3 - 2	0.08 - 0.3
		AH8015	-	50 - 200	0.3 - 2	0.08 - 0.3
		-	AH725	50 - 180	0.3 - 2	0.08 - 0.3
		-	NS9530	80 - 250	0.3 - 2	0.08 - 0.3
		-	GT9530	80 - 300	0.3 - 2	0.08 - 0.3
M	Stainless steel (Austenitic)	AH8015	-	50 - 150	0.3 - 2	0.08 - 0.3
		-	AH725	50 - 150	0.3 - 2	0.08 - 0.3
		-	T9215	50 - 200	0.3 - 2	0.08 - 0.3
	Stainless steel (Martensitic and ferritic)	AH8015	-	50 - 150	0.3 - 2	0.08 - 0.3
		-	AH725	50 - 150	0.3 - 2	0.08 - 0.3
		-	T9215	50 - 200	0.3 - 2	0.08 - 0.3
Stainless steel (Precipitation hardening)	AH8015	-	50 - 150	0.3 - 2	0.08 - 0.3	
	-	AH725	50 - 150	0.3 - 2	0.08 - 0.3	
	-	T9215	50 - 200	0.3 - 2	0.08 - 0.3	
K	Grey cast iron	T9215	-	100 - 350	0.3 - 2	0.08 - 0.3
		T9225	-	100 - 350	0.3 - 2	0.08 - 0.3
		-	AH8015	50 - 200	0.3 - 2	0.08 - 0.3
		-	AH725	50 - 180	0.3 - 2	0.08 - 0.3
		-	NS9530	80 - 250	0.3 - 2	0.08 - 0.3
		-	GT9530	80 - 300	0.3 - 2	0.08 - 0.3
	Ductile cast iron	T9215	-	100 - 350	0.3 - 2	0.08 - 0.3
		T9225	-	100 - 350	0.3 - 2	0.08 - 0.3
		-	AH8015	50 - 200	0.3 - 2	0.08 - 0.3
		-	AH725	50 - 180	0.3 - 2	0.08 - 0.3
		-	NS9530	80 - 250	0.3 - 2	0.08 - 0.3
		-	GT9530	80 - 300	0.3 - 2	0.08 - 0.3
N	Aluminum alloys	KS05F	-	100 - 300	0.3 - 2	0.08 - 0.3
	Copper alloys	KS05F	-	100 - 300	0.3 - 2	0.08 - 0.3
S	Titanium alloys	AH8015	-	20 - 80	0.3 - 2	0.08 - 0.3
	Nickel-based alloys	AH8015	-	20 - 80	0.3 - 2	0.08 - 0.3
H	Hardened steel	BXA20	-	50 - 220	0.12 - 0.8	0.1 - 0.3
		-	BXA10	50 - 220	0.12 - 0.8	0.1 - 0.3

Reference pages: A/E-SCLXR/L → **D021**, S-SCLXR/L-H → **D022**
A/E-SWLXR/L → **D023**, S-SWLXR/L-H → **D024**
A/E-SDXXR/L → **D036**

STANDARD CUTTING CONDITIONS

LNMX1204

*Values in red are for facing.

ISO	Workpiece material	Chip breaker	Grade	Cutting speed Vc (m/min)	Depth of cut: ap (mm)		Feed: f (mm/rev)	
					RE : 0.8	RE : 1.2	RE : 0.8	RE : 1.2
P	Steels S45C, SCM415, etc. C45, 18CrMo4, etc.	TDR	T9115	120 - 250	0.5 - 5 0.5 - 2.2	0.8 - 5 0.8 - 2.2	0.15 - 0.6	0.25 - 0.8
		TDR	T9125	80 - 180	0.5 - 5 0.5 - 2.2	0.8 - 5 0.8 - 2.2	0.15 - 0.6	0.25 - 0.8
M	Stainless steels SUS304, SUS316, etc. X5CrNi18-9, X5CrNiMo17-12-2, etc.	TDR	T9115	100 - 180	0.5 - 5 0.5 - 2.2	0.8 - 5 0.8 - 2.2	0.15 - 0.6	0.25 - 0.8
		TDR	T9125	80 - 180	0.5 - 5 0.5 - 2.2	0.8 - 5 0.8 - 2.2	0.15 - 0.6	0.25 - 0.8

LNMX1606

ISO	Workpiece material	Chip breaker	Grade	Cutting speed Vc (m/min)	Depth of cut: ap (mm)			Feed: f (mm/rev)		
					RE : 0.8	RE : 1.2	RE : 1.6	RE : 0.8	RE : 1.2	RE : 1.6
P	Steels S45C, SCM415, etc. C45, 18CrMo4, etc.	TDR	T9115	120 - 250	0.5 - 5 0.5 - 3.2	0.8 - 6 0.8 - 3.2	1 - 8 1 - 3.2	0.15 - 0.6	0.25 - 0.8	0.3 - 1
		TDR	T9125	80 - 180	0.5 - 5 0.5 - 3.2	0.8 - 6 0.8 - 3.2	1 - 8 1 - 3.2	0.15 - 0.6	0.25 - 0.8	0.3 - 1
		TWR	T9115	120 - 250	1 - 8 1 - 3.2	0.8 - 6 0.8 - 3.2	-	0.15 - 0.6	0.25 - 0.8	-
		TWR	T9125	80 - 180	1 - 8 1 - 3.2	0.8 - 6 0.8 - 3.2	-	0.15 - 0.6	0.25 - 0.8	-
M	Stainless steels SUS304, SUS316, etc. X5CrNi18-9, X5CrNiMo17-12-2, etc.	TDR	T9115	100 - 180	0.5 - 5 0.5 - 3.2	0.8 - 6 0.8 - 3.2	1 - 8 1 - 3.2	0.15 - 0.6	0.25 - 0.8	0.3 - 1
		TDR	T9125	80 - 180	0.5 - 5 0.5 - 3.2	0.8 - 6 0.8 - 3.2	1 - 8 1 - 3.2	0.15 - 0.6	0.25 - 0.8	0.3 - 1
		MDR	T9115	100 - 150	1.5 - 6 0.5 - 3.2	1.5 - 7 0.8 - 3.2	-	0.1 - 0.5	0.15 - 0.7	-
		MDR	AH725	50 - 150	1.5 - 6 0.5 - 3.2	1.5 - 7 0.8 - 3.2	-	0.1 - 0.5	0.15 - 0.7	-
		TWR	T9115	100 - 180	0.5 - 5 0.5 - 3.2	0.8 - 6 0.8 - 3.2	-	0.15 - 0.6	0.25 - 0.8	-
		TWR	T9125	80 - 180	0.5 - 5 0.5 - 3.2	0.8 - 6 0.8 - 3.2	-	0.15 - 0.6	0.25 - 0.8	-

LNMX2410

ISO	Workpiece material	Chip breaker	Grade	Cutting speed Vc (m/min)	Depth of cut: ap (mm)		Feed: f (mm/rev)	
					RE : 1.6	RE : 2.4	RE : 1.6	RE : 2.4
P	Steels S45C, SCM415, etc. C45, 18CrMo4, etc.	TDR	T9115	120 - 250	4 - 15 1 - 4.5	5 - 15 1 - 4.5	0.3 - 1	0.3 - 1.1
		TDR	T9125	80 - 150	4 - 15 1 - 4.5	5 - 15 1 - 4.5	0.3 - 1	0.3 - 1.1
M	Stainless steels SUS304, SUS316, etc. X5CrNi18-9, X5CrNiMo17-12-2, etc.	TDR	T9115	100 - 180	4 - 15 1 - 4.5	5 - 15 1 - 4.5	0.3 - 1	0.3 - 1.1
		TDR	T9125	80 - 150	4 - 15 1 - 4.5	5 - 15 1 - 4.5	0.3 - 1	0.3 - 1.1



STANDARD CUTTING CONDITIONS

DMIN	Description Insert	Depth of cut ap (mm)	Feed f (mm/rev)	Cutting speed: Vc (m/min)	
				Carbon steel, Alloy steel	Stainless steel
ø10	XOMU05X204-PS	0.5 - 3	0.05 - 0.2	50 - 180 m/min	50 - 160 m/min
ø12	XOMU06H204-PS	0.5 - 3.5			
ø14	XOMU07H304-PS	0.5 - 4.5			
ø16	XOMU08T304-PS	0.5 - 5			

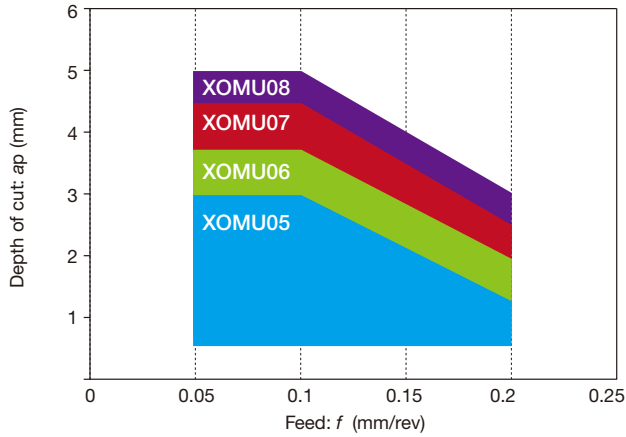

Threading Tool



Threading Tool - Content structure

- Products are listed by product series and thread shape to be machined.
- Inserts and toolholders in the catalog are our standard items.

How to use the page

Method ① Select the screw shape described at the left end of each page, jump to the page on the left index, and choose a designation you need **⑤** in the dimension table **⑥**. Applicable toolholders are shown in **⑦**.

Method ② Select the series name on **E003** and check the details on the product page.

Method ③ Select an item from Quick Guide on **E004 - E007**.

② TUNGTHREAD INSERT

60° thread angle

③

Right hand (RH) for internal threading. Right hand (RH) for external threading.

④ **⑤** **⑥** **⑦**

Applicable toolholder

Insert size	External	Internal
6	SNR1300/1050/1060...	SNR1300/1050/1060...
06	SNR1300/1050/1060...	SNR1300/1050/1060...
08	SNR1300/1050/1060...	SNR1300/1050/1060...
11	SER**11	SNR**11
16	CER/L**16, IC-CER/L**16	SNR**16, TSNR**16
	JSER**16...	SNR**16...
	JSER**16-CHP	TSNR**16-CHP
	B-SER/L**16	CNR/L**16...
	BC-SER/L**16	
22	CER/L**22, SER**22-CHP	TSNR**22, SNR**22...
27	CER/L**27	CNR/L**27

Partial-profile insert

Pitch (mm)	TPI	Designation	External insert				Internal insert				
			IC	PDX	PDY	RE	IC	PDX	PDY	RE	
0.5-1.5	48-16	16RA60	●	●	●	●	●	●	●	●	●
0.5-1.5	48-20	16RA60	●	●	●	●	●	●	●	●	●
0.5-1.5	48-16	16RA60	●	●	●	●	●	●	●	●	●
0.5-1.5	48-16	16RA60	●	●	●	●	●	●	●	●	●
0.5-1.5	48-16	16RA60	●	●	●	●	●	●	●	●	●
0.5-1.5	48-16	16RA60	●	●	●	●	●	●	●	●	●
0.5-3	48-8	16RA60	●	●	●	●	●	●	●	●	●
1.75-3	14-8	16RA60	●	●	●	●	●	●	●	●	●
1.75-3	14-8	16RA60	●	●	●	●	●	●	●	●	●
3.5-5	7-5	22RA60	●	●	●	●	●	●	●	●	●
3.5-5	7-5	22RA60	●	●	●	●	●	●	●	●	●
4-6	6-4	27RA60	●	●	●	●	●	●	●	●	●

Reference pages: External toolholders → E036 - E040
Internal toolholders → E054 - E056

TUNGTHREAD B-S/CER/L

External threading toolholder for Swiss lathes

③

⑤

Designation	H	B	LF	LH	HF	WF	Insert
B-SER10H16	20	10	100	15	10	16	16ER...
B-SER10K16	24	12	125	18	12	18	16ER...
B-CER/L16M16	32	16	150	24	16	22	16ER/L...

JS-SEL16

External threading toolholder for Swiss lathes

③

⑤

Designation	DCONMS	H	LF	LH	WF	Insert
JS16F-SEL16	16	15	85	25	11	16ER...
JS19G-SEL16	19.05	18	90	30	12.5	16ER...
JS19K-SEL16	19.05	18	100	30	12.5	16ER...
JS20K-SEL16	20	19	90	30	13	16ER...
JS20X-SEL16	20	19	100	30	13	16ER...
JS20HSEL16	25	24	100	30	15.5	16ER...
JS25K-SEL16	25.4	24	100	30	15.7	16ER...

Note: Use the right-hand insert (16ER...) for a left-hand holder (JS**SEL16).

⑧

SPARE PARTS

Designation	Coating	Coating	Coating	Coating
B-SER**16	-	-	CSTB-3.5	T-15F
B-CER/L16M16	CSP16	A16-1	-	T-15F
JS**SEL16	-	-	CSTB-3.5	T-15F

⑨ Reference pages: Inserts → E010 - E011, E015, E017 - E030

- ①** : Screw shape
- ②** : Series name
- ③** : Drawing of thread, threading insert, threading toolholder
- ④** : Applicable pitch and the number of threads
- ⑤** : Designation (for external, for internal)
- ⑥** : Dimension table (conforming to ISO13399)
- ⑦** : Applicable toolholder
- ⑧** : Spare parts
- ⑨** : Reference page

When ordering

- Please specify the designation and quantity for threading toolholders.
e.g. **TSNR0020R22 ... 1** (one threading toolholder per package)
- Please specify the designation, grade, and quantity for threading inserts.
e.g. **16IR175ISO AH725 ... 5** (five threading inserts per package)

Main products

Thread form	
60°	E010
55°	E015
M (Metric)	E017
UN (Unified)	E021
W (Whitworth)	E023
BSPT (R, PT)	E024
NPT	E025
NPTF	E026
TR (Metric, 30° Trapezoidal)	E027
Round (DIN405)	E027
UNJ	E028
MJ	E028
ACME (29° Trapezoidal)	E029
STUB ACME (29° Trapezoidal)	E030
API Round	E030
API Buttress	E032
API Rotary Shoulder Connection	E035



TUNGTHREAD

Lay down insert, toolholder

Standard items cover a wide variety of threading inserts. Standard tool series with double-clamp system for excellent insert stability in machining API-standard threads.

E004 -, E010 -
E067



TETRAMCUT

Standard tool with 4 corners for threading on Swiss lathes. In small diameter threading using the center of the tool post on general NC lathes, interference with the center is less likely occur.

E004 -, E008



DUOJUST

Standard tool suitable for all types of threading on Swiss lathes. The incomplete thread part from the workpiece face to the thread groove can be the shortest thanks to the excellent accessibility to the workpiece face.

E004 -, E009



J-SERIES

Tool series with 3-cornered inserts. Subselection for threading on Swiss lathes. Standard tool also suitable for radial Swiss lathes.

E004, E013
E016, E048



TUNGT-CLAMP

Tool with high clamp rigidity that firmly holds the insert with a clamp. Grooving insert and threading insert can be used with the same toolholder.

E004 -, E014
E062 -, E068



On edge insert, toolholder

ACME and STUB ACME inserts can be used for the range of 16 to 3TPI with 2 types of toolholders. The special full-profile insert realizes both the fine adjustment of thread height and the minimum burr on the crest.

E004 -, E029 -
E052, E065



Chaser

Threading tool with multiple cutting edges for highly efficient machining of API-standard round, buttress, and NPT.

E005 -, E026
E031 -, E053
E066



BOREMEISTER

Boring heads for deep hole threading. All 16-size inserts of TungThread Internal series are applicable, allowing to apply for large variety of threads type.

E056 -



TINYMINTURN

Internal threading tool suitable for the minimum machining diameter $\varnothing 4$. All tools have oil holes that can supply coolant from the cutting edge.

E059 -, E068







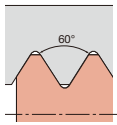
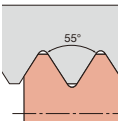
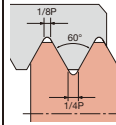
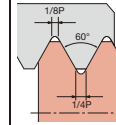
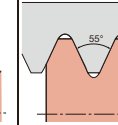
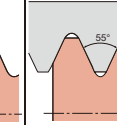
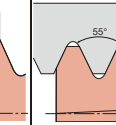

Other tool

TT type

E004 -, E014
E016, E053,
E066

Applicable tool for each external thread type

Applicable tool for each external thread type		General purpose, Machine parts for machine and automotive parts				For valve and pump parts; pneumatic, hydraulic, oil and gas pipes		
Thread types		60°	55°	ISO metric threads, coarse and fine	Unified national threads series, 60° inch threads	- British standard whitworth - British standard fine	- British standard parallel pipe - British standard pipe - Parallel pipe thread (JIS B 9912) - 55° inch thread	- JIS tapered pipe thread - British standard pipe taper
Thread symbols		M, UN, UNC, UNF, UNEF, UNS	G, BSP, PF, BSPP	M	UN, UNR, UNC, UNRC, UNF, UNRF, UNEF, UNREF, UNS, UNRS	BSW, BSF, W	G, BSP, PF, BSPP	R, PT, BSPT
Thread form								
Tool type	Full profile							
	With Without							
ST type 	○	—	—	0.5 ~ 6 mm E017	32 ~ 5TPI E021	28 ~ 5TPI E023	28 ~ 5TPI E023	28 ~ 11TPI E024
	○	0.5 ~ 6 mm 48 ~ 4TPI E010	0.5 ~ 5 mm 48 ~ 5TPI E015	—	—	—	—	—
TETRAMCUT 	○	—	—	0.5 ~ 1.5 mm E020	—	—	—	—
	○	0.4 ~ 3 mm 64 ~ 8TPI E012	—	—	—	—	—	—
DUOJ CUT 	○	0.2 ~ 1.5 mm 127 ~ 16TPI E012	—	—	—	—	—	—
	○	0.5 ~ 1 mm 48 ~ 25TPI E013	0.5 ~ 1 mm 48 ~ 25TPI E016	—	—	—	—	—
TUNG-CLAMP 	○	1.27 ~ 4.23 mm 20 ~ 6TPI E014	—	—	—	—	—	—
	○	~ 3 mm ~ 8TPI E014	~ 3 mm ~ 8TPI E016	—	—	—	—	—
TT type 	○	—	—	—	—	—	—	—
	○	—	—	—	—	—	—	—

Please see page E*** for the product details.

Applicable tool for each external thread type		For valve and pump parts; pneumatic, hydraulic, oil and gas pipes		Machine parts		Aerospace threads	
Thread types		National pipe taper thread	National pipe taper fuel thread	- TR - 30° trapezoidal - ISO trapezoidal	Knuckle thread	Unified inch screw threads	
Thread symbols		NPT	NPTF	TR	Rd	UNJ, UNJC, UNJF, UNUEF, UNJS	
Thread form							
Tool type	Full profile						
	With						
Without							
ST type E036	○	0.5 ~ 5 mm 48 ~ 5TPI E025	—	0.5 ~ 6 mm E027	32 ~ 5TPI E027	28 ~ 5TPI E028	
Chaser E053	○	11.5TPI, 8TPI E026	—	—	—	—	

Applicable tool for each external thread type		Oil and gas fields and OCTG drill pipes					Machine parts, Pipe			
Thread types		- API round - API casing - Short casing - API tubing	API buttress casing	- API rotary shoulder connection for drill pipe and collar connections					- ACME - 29° trapezoidal thread	- STUB ACME - 29° trapezoidal thread
Thread symbols		CSG, LCSG, TBG, UPTBG	BCSG	NC	NC	REG	REG, FH	REG	—	—
Thread form										
Tool type	Full profile									
	With									
Without										
ST type E036	○	10TPI, 8TPI E030	5TPI (0.75TPF) E032	—	—	—	—	—	12 ~ 5TPI E029	—
Chaser E053	○	10TPI, 8TPI E031	5TPI (0.75TPF) E033	—	—	—	—	—	—	—
Other E051	○	10TPI, 8TPI E031	5TPI (0.75TPF) 5TPI (1TPF) E032	4TPI (2TPF) 4TPI (3TPF) 5TPI (3TPF) E035					16 ~ 3TPI E029	16 ~ 3TPI E030

Please see page E*** for the product details.

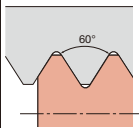
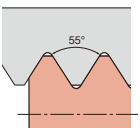
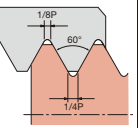
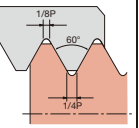
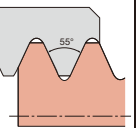
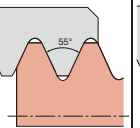
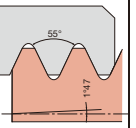
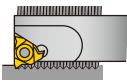
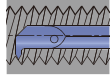
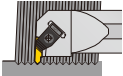
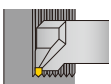

Applicable tool for each internal thread type

Applicable tool for each external thread type		General purpose, Machine parts for machine and automotive parts				For valve and pump parts; pneumatic, hydraulic, oil and gas pipes		
Thread types		60°	55°	ISO metric threads, coarse and fine	Unified national threads series, 60° inch threads	- British standard whitworth - British standard fine	- British standard parallel pipe - British standard pipe - Parallel pipe thread (JIS B 9912) - 55° inch thread	- JIS tapered pipe thread - British standard pipe taper
Thread symbols		M, UN, UNC, UNF, UNEF, UNS	G, BSP, PF, BSPP	M	UN, UNR, UNC, UNRC, UNF, UNRF, UNEF, UNREF, UNS, UNRS	BSW, BSF, W	G, BSP, PF, BSPP	R, PT, BSPT
Thread form								
Tool type	Full profile							
	With / Without							
ST type 	○	—	—	0.5 ~ 6 mm E017	32 ~ 5TPI E021	28 ~ 5TPI E023	28 ~ 5TPI E023	19 ~ 11TPI E024
	○	0.5 ~ 6 mm E010	0.5 ~ 5 mm E015	—	—	—	—	—
TINYTURN 	○	0.5 ~ 1.5 mm E060	—	—	—	—	—	—
TUNG-CLAMP 	○	1.27 ~ 4.23 mm E014	—	—	—	—	—	—
TT type 	○	~ 3 mm ~ 8TPI E014	~ 3 mm ~ 8TPI E016	—	—	—	—	—

Please see page E*** for the product details.

Applicable tool for each external thread type		For valve and pump parts; pneumatic, hydraulic, oil and gas pipes		Machine parts		Aerospace threads	
Thread types		National pipe taper thread	National pipe taper fuel thread	- TR - 30° trapezoidal - ISO trapezoidal	Knuckle thread	Aerospace standard MJ threads	Unified inch screw threads
Thread symbols		NPT	NPTF	TR	Rd	MJ	UNJ, UNJC, UNJF, UNUEF, UNJS
Thread form							
Tool type	Full profile						
	With						
ST type	Without						
	With						
 E054	○	27 ~ 8TPI E025	14 ~ 8TPI E026	1.5 ~ 5 mm E027	6TPI E027	1 mm E028	—
 E065	○	11.5TPI, 8TPI E026	—	—	—	—	—

Applicable tool for each external thread type		Oil and gas fields and OCTG drill pipes					Machine parts, Pipe			
Thread types		- API round - API casing - API tubing - Short casing	API buttress casing	- API rotary shoulder connection for drill pipe and collar connections					ACME 29° trapezoidal thread	STUB ACME 29° trapezoidal thread
Thread symbols		CSG, LCSG, TBG, UPTBG	BCSG	V-0.038R 2TPF	V-0.038R 3TPF	V-0.040R 3TPF	V-0.050R 2TPF	V-0.050R 3TPF	—	—
Thread form										
Tool type	Full profile									
	With									
ST type	Without									
	With									
 E054	○	10TPI, 8TPI E030	5TPI (0.75TPF) E032	—	—	—	—	—	12 ~ 5TPI E029	—
 E065	○	10TPI, 8TPI E031	5TPI (0.75TPF) E033	—	—	—	—	—	—	—
 E063	○	10TPI, 8TPI E031	5TPI (0.75TPF) 5TPI (1TPF) E032	4TPI (2TPF) 4TPI (3TPF) 5TPI (3TPF) E035					—	—

Please see page E*** for the product details.



TETRAMCUT



Unique clamping system

The unique pocket design provides accurate indexing repeatability of the cutting edge height.

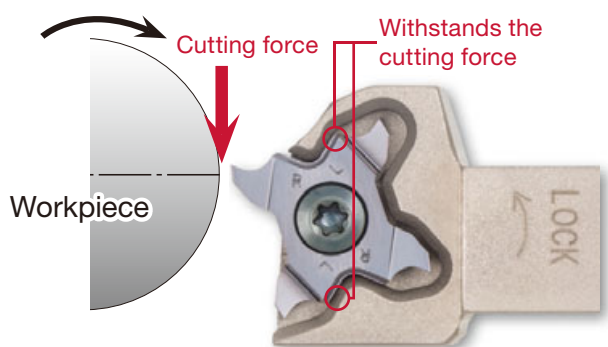

No tool interference with the lathe center when machining small parts

TETRAMCUT M16x1

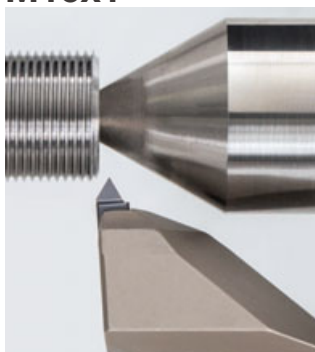

Insert: TCT18R-60N-020

Conventional M24x1



Insert: 16ER10ISO

Reference pages: Inserts → [E012](#), External toolholders → [E041](#) - [E043](#), Standard cutting conditions → [E067](#)



Unique clamping system for highly rigid clamping

The unused cutting edge is always protected due to the innovative clamping system. Even if the first cutting edge is chipped, the other unused cutting edge can be used because the insert is clamped in the center.

Insert is secured at 3 points



Excellent accessibility to the workpiece face

Utilizing various tools minimizes the incomplete thread part.



	Type A	Type B	Type N
Right hand	$a > b$	$a < b$	$a = b$
Left hand	$a > b$	$a < b$	$a = b$



Insert designation	Cutting edge geometry (mm)	PDX (mm)	Pitch (mm)										
			0.2	0.25	0.35	0.4	0.5	0.6	0.8	1	1.25	1.5	
JXTG12FR-60A-000	0.05 (flat)	0.25	Applicable area										
JXTG12FL-60A-000													
JXTG12FR-60B-000	0.05 (flat)	2.25	Applicable area										
JXTG12FL-60B-000													
JXTG12FR-60A-005	R0.05	0.6	Applicable area										
JXTG12FL-60A-005													
JXTG12FR-60B-005	R0.05	1.9	Applicable area										
JXTG12FL-60B-005													
JXTG12FR-60N-010	R0.1	1.25	Applicable area										
JXTG12FL-60N-010													

127 72 52 32 16

Threads per inch (TPI)

Reference pages: Inserts → **E012**, External toolholders → **E047 - E048**,
Standard cutting conditions → **E067**

Partial-profile insert with chipbreaker

Insert size	Pitch (Reference)	TPI	Hand of cut	External insert								Internal insert														
				Designation	Grade			IC	PDX	PDY	RE	Designation	Grade			IC	PDX	PDY	RE							
					Coated		Cermet						Coated		Cermet											
					AH8015	AH725	NS9530						AH8015	AH725	NS9530											
11	0.5 - 1.5	48 - 16	R															11IRA60-B		●			6.35	0.9	0.7	0.04
11	0.5 - 1.5	48 - 16	R															11IRA60-M	●		●		6.35	0.9	0.7	0.04
16	0.5 - 1.5	48 - 16	R	16ERA60-B		●*			9.525	0.9	0.8	0.05	16IRA60-B		●*			9.525	0.9	0.8	0.05					
16	0.5 - 1.5	48 - 16	R	16ERA60-M	●			●	9.525	0.9	0.7	0.06	16IRA60-M	●			●	9.525	0.9	0.7	0.04					
16	0.5 - 3	48 - 8	R	16ERAG60-B		●*			9.525	1.7	1.2	0.08	16IRAG60-B		●*			9.525	1.7	1.2	0.05					
16	0.5 - 3	48 - 8	R	16ERAG60-M	●	●		●	9.525	1.6	1.2	0.06	16IRAG60-M	●	●		●	9.525	1.6	1.2	0.04					
16	1.75 - 3	14 - 8	R	16ERG60-B		●*			9.525	1.7	1.2	0.25	16IRG60-B		●*			9.525	1.7	1.2	0.1					
16	1.75 - 3	14 - 8	R	16ERG60-M	●			●	9.525	1.6	1.2	0.22	16IRG60-M	●			●	9.525	1.6	1.2	0.14					
22	3.5 - 5	7 - 5	R	22ERN60-B		●			12.7	2.5	1.7	0.32	22IRN60-B		●			12.7	2.5	1.7	0.19					

- ●* : The cutting edge position needs re-adjusting for these inserts have different PDY and PDX dimensions (Note: for size 16 inserts only).

- ■ requires the use of dedicated shim.

When using a new AH725 with chipbreaker, the conventional shim may need to be replaced with a new standard shim. Please refer to the page [E69](#).

● : Line up / 5 pieces per package

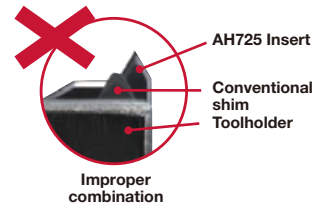

60° thread angle (General purpose)

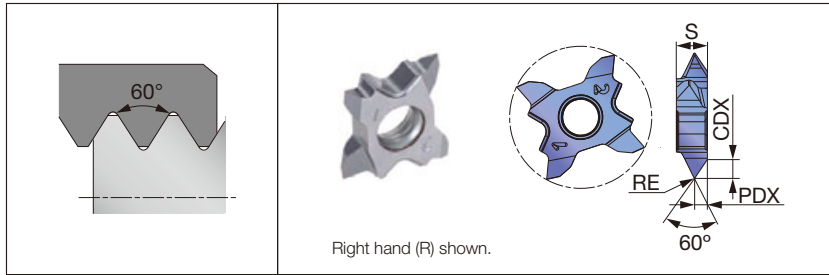

Applicable toolholder

External
STCR/L**-18
STCR/L**18-CHP
JS**-STCL18
C*STCFL**18-CHP
C*STCR/L**18-CHP
QC**STCR/L18 (-Y)
QC**STCR/L18 (-Y)-CHP

Thread form

60°

55°

M (Metric)

UN (Unified)

W (Whitworth)

BSPT (R, PT)

NPT

NPTF

TR (Metric, 30° Trapezoidal)

Round (DIN405)

UNJ

MJ

ACME (29° Trapezoidal)

STUB ACME (29° Trapezoidal)

API Round

API Buttress

API Rotary Shoulder Connection

Partial-profile insert

Pitch	TPI	Hand of cut	External insert						
			Designation	Grade		PDX	CDX	RE	S
				Coated					
SH725	AH725								
0.4 - 1	25 - 64	R	TCT18FR-60A-005	●		0.6	0.99	0.05	4
1 - 2	25 - 12	R	TCT18FR-60A-010	●		1	1.63	0.1	4
0.8 - 3	8 - 32	R/L	TCT18R/L-60N-010		●	1.6	2.67	0.1	4
1.5 - 3	8 - 16	R/L	TCT18R/L-60N-020		●	1.6	2.57	0.2	4

● : Line up / 5 pieces per package

DUOJUST

INSERT

60° thread angle (General purpose)

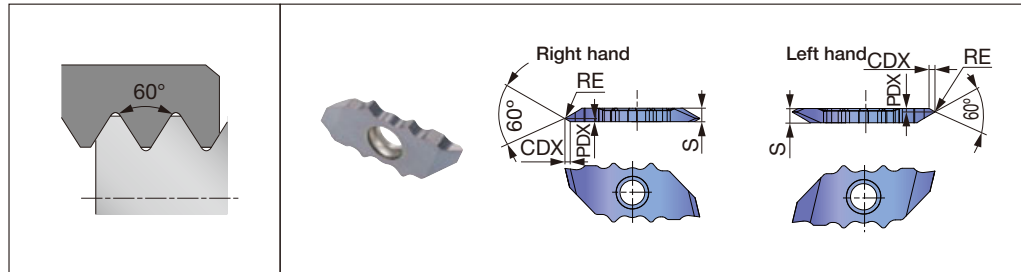

Applicable toolholder

External
JSXXR/L**09
JSXXR/L**09-CHP
JS**-SXXL09

Partial-profile insert

Insert size	Pitch	TPI	Hand of cut	External insert						
				Designation	Grade		PDX	CDX	RE	S
					Coated					
R	L									
12	0.2 - 0.4	64 - 127	R/L	JXTG12FR/L-60A-000	●	●	0.25	0.4	0.05 max flat	2.5
12	0.2 - 0.4	64 - 127	R/L	JXTG12FR/L-60B-000	●	●	2.25	0.4	0.05 max flat	2.5
12	0.4 - 1	25 - 64	R/L	JXTG12FR/L-60A-005	●	●	0.6	0.99	0.05	2.5
12	0.4 - 1	25 - 64	R/L	JXTG12FR/L-60B-005	●	●	1.9	0.99	0.05	2.5
12	1 - 1.5	16 - 25	R/L	JXTG12FR/L-60N-010	●	●	1.25	2.07	0.1	2.5

● : Line up / 5 pieces per package

	Type A	Type B	Type N
Right hand			
Left hand			

Reference pages: TetraMini-Cut : External toolholders → **E041 - E045**

DuoJust-cut : External toolholders → **E047 - E048**

60° thread angle (General purpose)

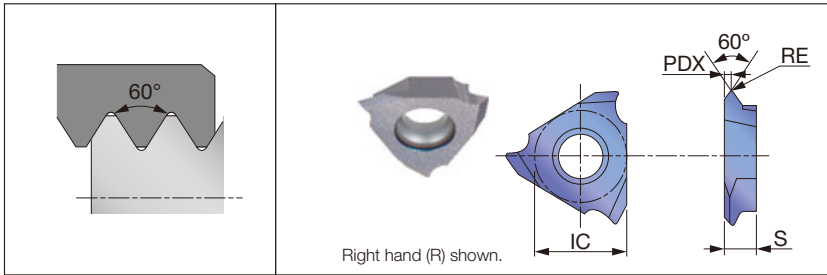

Applicable toolholder

External
JSTTR/L**3
JS**-TTL3

Partial-profile insert

Pitch	TPI	Hand of cut	External insert												
			Designation	Grade								IC	PDX	S	RE
				Coated				Cermet		Uncoated					
				SH725		J740		NS9530		TH10					
R	L	R	L	R	L	R	L								
0.5 - 1	25 - 48	R/L	JTTR3005F	●	●	●	●	●	●	●	●	9.525	0.6	3.18	0.05
0.5 - 1	25 - 48	R/L	JTTL3010F	●	●	●	●	●	●	●	●	9.525	1.1	3.18	0.1

● : Line up / 10 pieces per package

60° thread angle (General purpose)



Applicable toolholder

External
JSXBR**K8
JSXBR**K8-C

Partial-profile insert

Pitch	TPI	Hand of cut	External insert					
			Designation	Grade		IC	S	RE
				Coated	Uncoated			
				J740	TH10			
0.5 - 1	25 - 48	R	JXT1R6000F	●	●	8	3.97	0.03
0.5 - 1	25 - 48	R	JXT2R6000F	●	●	8	3.97	0.03

● : Line up / 10 pieces per package



TUNG T-CLAMP

INSERT

60° thread angle (General purpose)

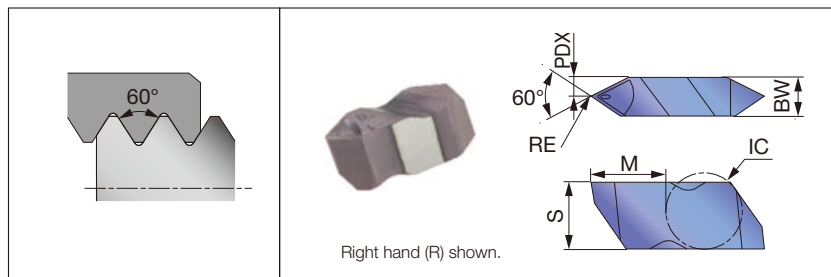

Applicable toolholder

External	Internal
FLASR/L-1616M3	A**M-FLER/L3
FLSR/L-**M3	HS**-FLER3W

Thread form

60°

Partial-profile insert for external and internal threads

TPI	Hand of cut	External Pitch	Internal Pitch	Designation	Grade		IC	PDX	BW	RE	S	M
					Coated	AH725						
6 - 20	R/L	1.27 - 4.23	2.11 - 5.08	FLT-3R/L-HCB	●		9.525	2.49	4.95	0.17	8.74	10.16
11 - 20	R/L	2.31 - 4.23	3.175 - 5.08	FLT-3R/LC-HCB	●		9.525	2.49	4.95	0.35	8.74	10.16
6 - 20	R/L	1.27 - 4.23	2.11 - 5.08	FLT-3R/L-CB	●		9.525	2.49	4.95	0.17	8.74	10.16

● : Line up / 10 pieces per package

M (Metric)

UN (Unified)

W (Whitworth)

BSPT (R, PT)

NPT

NPTF

TUNG THREAD

INSERT

TT type / 60° thread angle (General purpose)

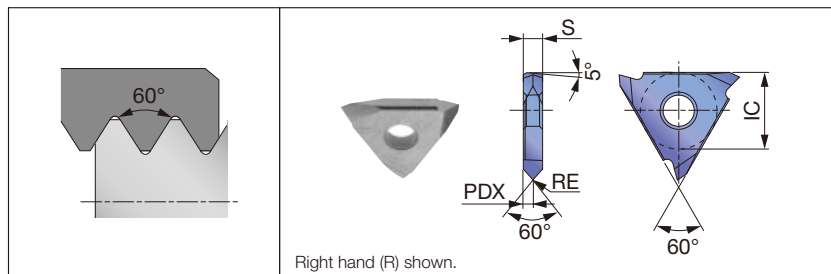

Applicable toolholder

External	Internal
TT-****RE/LI	TT-2525RI

Round (DIN405)

UNJ

MJ

ACME (29° Trapezoidal)

Partial-profile insert for external and internal threads

Pitch	TPI	Hand of cut	Designation	Grade		IC	PDX	S	RE
				Cermet	Uncoated				
≤ 3	≥ 8	R	TTR42M-005	●	●	12.7	1.6	3.2	0.05
≤ 3	≥ 8	L	TTL42M-005	●	●	12.7	1.6	3.2	0.05

● : Line up / 5 pieces per package

STUB ACME (29° Trapezoidal)

API Round

API Buttress

API Rotary Shoulder Connection

Reference pages: TungT-Clamp : External toolholders → **E050**,
 Internal toolholders → **E063 - E064**
 TT type : External toolholders → **E053**
 Internal toolholders → **E066**

55° thread angle (General purpose)

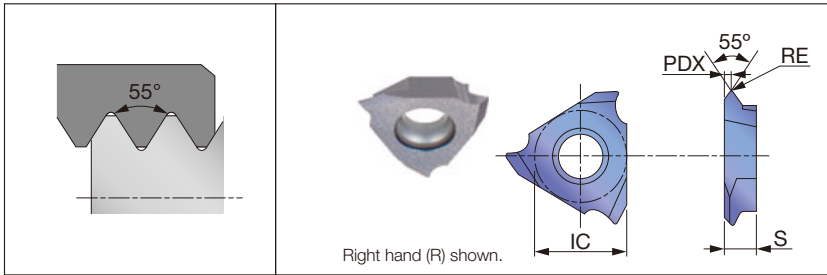

Applicable toolholder

External
JSTTR/L**3
JS**-TTL3

Thread form

60°

55°

M (Metric)

UN (Unified)

W (Whitworth)

BSPT (R, PT)

NPT

NPTF

TR (Metric, 30° Trapezoidal)

Round (DIN405)

UNJ

MJ

ACME (29° Trapezoidal)

STUB ACME (29° Trapezoidal)

API Round

API Buttress

API Rotary Shoulder Connection

Partial-profile insert

Pitch	TPI	Hand of cut	Designation	External insert				IC	PDX	S	RE
				Grade							
				Coated							
				SH725		J740					
				R	L	R	L				
0.5 - 1	25 - 48	R/L	JTTR/L3005F-55	●		●		9.525	0.6	3.18	0.05

● : Line up / 5 pieces per package

TUNGTHREAD

INSERT

TT type / 55° thread angle (General purpose)

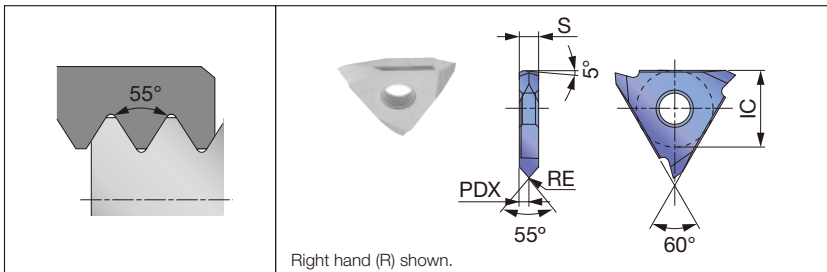

Applicable toolholder

External	Internal
TT-****RE/LI	TT-2525RI

Partial-profile insert for external and internal threads

Pitch	TPI	Hand of cut	Designation	Grade		IC	PDX	S	RE
				Cermet	Uncoated				
				NS9530	TH10				
≤ 3	≥ 8	R	TTR42W-005	●	●	12.7	1.6	3.2	0.05
≤ 3	≥ 8	L	TTL42W-005	●	●	12.7	1.6	3.2	0.05

● : Line up / 5 pieces per package

Reference pages: J-Series: External toolholders → [E048 - E049](#)

TT type: External toolholders → [E053](#)

Internal toolholders → [E066](#)

ISO metric (General purpose)

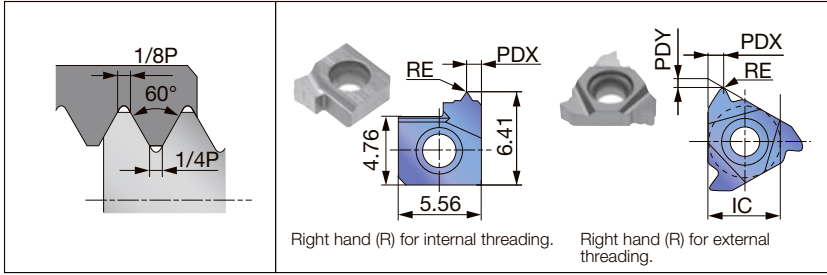

Applicable toolholder

Insert size	External	Internal
6		SNR/L000*K06SC... SNR/L000*H06...
06		SIR0005...
08		SIR0007...
11	SER**11	SNR/L**11...
16	CER/L**16... (C*CER/L...) JSER**16... JS**SEL16 SER**16-CHP B-SER/L**16 B-CER/L**16 BC-SER/L**16	TSNR/L**16 SNR/L**16... TCNR/L**16... CNR/L**16...
22	CER/L**22... SER**22-CHP	TSNR/L**22 SNR/L**22... TCNR/L**22... CNR/L**22...
27	CER/L**27...	CNR/L**27...

Full-profile insert

Insert size	Pitch (Reference)	Hand of cut	External insert								Internal insert									
			Designation	Grade				IC	PDX	PDY	RE	Designation	Grade				IC	PDX	PDY	RE
				Coated		Uncoated							Coated		Uncoated					
				AH8015	AH725	T313V	TH10						AH8015	AH725	T313V	TH10				
6	0.75	R								6IR075ISO	●		●	-	0.5	-	0.05			
6	1	R								6IR10ISO	●	●	●	-	0.9	-	0.07			
6	1.25	R								6IR125ISO	●	●	●	-	0.9	-	0.09			
6	1.5	R								6IR15ISO	●	●	●	-	0.9	-	0.11			
6	1.75	R								6IR175ISO	●	●	●	-	0.9	-	0.12			
6	2	R								6IR20ISO	●	●	●	-	0.9	-	0.14			
06	0.5	R								06IR05ISO	●**			4	0.4	0.6	0.04			
06	0.75	R								06IR075ISO	●**			4	0.5	0.6	0.06			
06	1	R								06IR10ISO	●**			4	0.6	0.6	0.05			
06	1.25	R								06IR125ISO	●**			4	0.6	0.6	0.07			
08	1	R								08IR10ISO	●**			5	0.6	0.6	0.07			
08	1.25	R								08IR125ISO	●**			5	0.7	0.7	0.09			
08	1.5	R								08IR15ISO	●**			5	0.7	0.7	0.1			
08	1.75	R								08IR175ISO	●**			5	0.8	0.6	0.15			
11	0.35	R	11ER035ISO	●				6.35	0.4	0.6	0.04									
11	0.5	R	11ER05ISO	●				6.35	0.6	0.6	0.07	11IR05ISO	●	●	6.35	0.5	1.2	0.04		
11	0.7	R	11ER07ISO	●				6.35	0.6	0.6	0.11									
11	0.75	R	11ER075ISO	●				6.35	0.6	0.6	0.11	11IR075ISO	●	●	6.35	0.5	1.2	0.05		
11	0.8	R	11ER080ISO	●				6.35	0.6	0.6	0.12									
11	1	R	11ER10ISO	●				6.35	0.7	0.7	0.15	11IR10ISO	●	●	6.35	0.9	0.7	0.07		
11	1	L										11IL10ISO	●	●	6.35	0.9	0.7	0.07		
11	1.25	R	11ER125ISO	●				6.35	0.9	0.8	0.16	11IR125ISO	●		6.35	0.9	0.7	0.09		
11	1.25	L										11IL125ISO	●		6.35	0.9	0.7	0.09		
11	1.5	R	11ER15ISO	●				6.35	0.8	1	0.19	11IR15ISO	●	●	6.35	0.9	0.7	0.11		
11	1.5	L										11IL15ISO	●	●	6.35	0.9	0.7	0.11		
11	1.75	R										11IR175ISO	●	●	6.35	0.9	0.7	0.12		
11	1.75	L										11IL175ISO	●		6.35	0.9	0.7	0.12		
11	2	R										11IR20ISO	●	●	6.35	0.9	0.7	0.14		
11	2	L										11IL20ISO	●	●	6.35	0.9	0.7	0.14		

●** : Both ..06IR... and ..08IR... inserts have 3 cutting edges.

● : Line up / 5 pieces per package

Reference pages: External toolholders → **E036 - E040**
Internal toolholders → **E054 - E056**

TUNGTHREAD

INSERT

Insert size	Pitch (Reference)	Hand of cut	External insert								Internal insert									
			Designation	Grade				IC	PDX	PDY	RE	Designation	Grade				IC	PDX	PDY	RE
				Coated			Uncoated						Coated			Uncoated				
				AH8015	AH725	T313V	TH10						AH8015	AH725	T313V	TH10				
16	0.5	R	16ER05ISO	●	●	●	●	9.525	0.5	1.2	0.06	16IR05ISO	●	●	●	●	9.525	0.5	1.2	0.04
16	0.75	R	16ER075ISO	●	●	●	●	9.525	0.5	1.2	0.09	16IR075ISO	●	●	●	●	9.525	0.5	1.2	0.05
16	1	R	16ER10ISO	●	●	●	●	9.525	0.9	0.7	0.13	16IR10ISO	●	●	●	●	9.525	0.9	0.7	0.07
16	1	L										16IL10ISO	●	●	●	●	9.525	0.9	0.7	0.07
16	1.25	R	16ER125ISO	●	●	●	●	9.525	0.9	0.7	0.16	16IR125ISO	●	●	●	●	9.525	0.9	0.7	0.09
16	1.25	L										16IL125ISO	●	●	●	●	9.525	0.9	0.7	0.09
16	1.5	R	16ER15ISO	●	●	●	●	9.525	0.9	0.7	0.19	16IR15ISO	●	●	●	●	9.525	0.9	0.7	0.11
16	1.5	L	16EL15ISO	●	●	●	●	9.525	0.9	0.7	0.19	16IL15ISO	●	●	●	●	9.525	0.9	0.7	0.11
16	1.75	R	16ER175ISO	●	●	●	●	9.525	1.6	1.2	0.22	16IR175ISO	●	●	●	●	9.525	1.6	1.2	0.12
16	2	R	16ER20ISO	●	●	●	●	9.525	1.6	1.2	0.25	16IR20ISO	●	●	●	●	9.525	1.6	1.2	0.14
16	2	L	16EL20ISO	●	●	●	●	9.525	1.6	1.2	0.25	16IL20ISO	●	●	●	●	9.525	1.6	1.2	0.14
16	2.5	R	16ER25ISO	●	●	●	●	9.525	1.6	1.2	0.31	16IR25ISO	●	●	●	●	9.525	1.6	1.2	0.18
16	3	R	16ER30ISO	●	●	●	●	9.525	1.6	1.2	0.38	16IR30ISO	●	●	●	●	9.525	1.6	1.2	0.21
16	3	L										16IL30ISO	●	●	●	●	9.525	1.6	1.2	0.21
22	3.5	R	22ER35ISO	●	●	●	●	12.7	2.5	1.7	0.44	22IR35ISO	●	●	●	●	12.7	2.5	1.7	0.25
22	4	R	22ER40ISO	●	●	●	●	12.7	2.5	1.7	0.5	22IR40ISO	●	●	●	●	12.7	2.5	1.7	0.28
22	4.5	R	22ER45ISO	●	●	●	●	12.7	2.5	1.7	0.56	22IR45ISO	●	●	●	●	12.7	2.5	1.7	0.32
22	5	R	22ER50ISO	●	●	●	●	12.7	2.5	1.7	0.63	22IR50ISO	●	●	●	●	12.7	2.5	1.7	0.35
27	6	R	27ER60ISO	●	●	●	●	15.875	3.2	2.2	0.75	27IR60ISO	●	●	●	●	15.875	3.2	2.2	0.42

● : Line up / 5 pieces per package

Reference pages: External toolholders → [E036 - E040](#), Internal toolholders → [E054 - E056](#)

Full-profile insert with chipbreaker

Insert size	Pitch (Reference)	Hand of cut	External insert								Internal insert							
			Designation	Grade			IC	PDX	PDY	RE	Designation	Grade			IC	PDX	PDY	RE
				Coated		Cermet						Coated		Cermet				
				AH8015	AH725	NS9530						AH8015	AH725	NS9530				
11	0.5	R								11IR05ISO-B	●		6.35	0.5	1.2	0.04		
11	0.5	R								11IR05ISO-M		●	6.35	0.5	1.2	0.04		
11	0.75	R								11IR075ISO-B	●		6.35	0.5	1.2	0.05		
11	0.75	R								11IR075ISO-M		●	6.35	0.5	1.2	0.05		
11	1	R								11IR10ISO-B	●		6.35	0.9	0.7	0.08		
11	1	R								11IR10ISO-M	●	●	6.35	0.9	0.7	0.08		
11	1.25	R								11IR125ISO-B	●		6.35	0.9	0.7	0.1		
11	1.25	R								11IR125ISO-M	●	●	6.35	0.9	0.7	0.1		
11	1.5	R								11IR15ISO-B	●		6.35	0.9	0.7	0.12		
11	1.5	R								11IR15ISO-M	●	●	6.35	0.9	0.7	0.12		
11	1.75	R								11IR175ISO-B	●		6.35	0.9	0.7	0.12		
11	1.75	R								11IR175ISO-M		●	6.35	0.9	0.7	0.12		
11	2	R								11IR20ISO-B	●		6.35	0.9	0.7	0.14		
11	2	R								11IR20ISO-M	●	●	6.35	0.9	0.7	0.14		
16	0.5	R	16ER05ISO-M			●	9.525	0.5	1.2	0.06								
16	0.75	R	16ER075ISO-B		●*		9.525	0.6	0.6	0.08								
16	0.75	R	16ER075ISO-M	●		●	9.525	0.5	1.2	0.09								
16	1	R	16ER10ISO-B		●*		9.525	0.7	0.7	0.11	16IR10ISO-B		●*	9.525	0.7	0.6	0.05	
16	1	R	16ER10ISO-M	●	●	●	9.525	0.9	0.7	0.13	16IR10ISO-M	●	●	9.525	0.9	0.7	0.08	
16	1.25	R	16ER125ISO-B		●*		9.525	0.9	0.8	0.14	16IR125ISO-B		●*	9.525	0.9	0.8	0.06	
16	1.25	R	16ER125ISO-M	●		●	9.525	0.9	0.7	0.16	16IR125ISO-M	●	●	9.525	0.9	0.7	0.1	
16	1.5	R	16ER15ISO-B		●*		9.525	1	0.8	0.19	16IR15ISO-B		●*	9.525	1	0.8	0.08	
16	1.5	R	16ER15ISO-M	●	●	●	9.525	0.9	0.7	0.19	16IR15ISO-M	●	●	9.525	0.9	0.7	0.12	
16	1.75	R	16ER175ISO-B		●*		9.525	1.2	0.9	0.25	16IR175ISO-B		●*	9.525	1.2	0.9	0.10	
16	1.75	R	16ER175ISO-M	●		●	9.525	1.6	1.2	0.22	16IR175ISO-M	●	●	9.525	1.6	1.2	0.14	
16	2	R	16ER20ISO-B		●*		9.525	1.3	1	0.28	16IR20ISO-B		●*	9.525	1.3	1	0.11	
16	2	R	16ER20ISO-M	●	●	●	9.525	1.6	1.2	0.25	16IR20ISO-M	●	●	9.525	1.6	1.2	0.14	
16	2.5	R	16ER25ISO-B		●*		9.525	1.5	1.1	0.3	16IR25ISO-B		●*	9.525	1.5	1.1	0.14	
16	2.5	R	16ER25ISO-M	●		●	9.525	1.6	1.2	0.31	16IR25ISO-M	●	●	9.525	1.6	1.2	0.18	
16	3	R	16ER30ISO-B		●*		9.525	1.6	1.2	0.38	16IR30ISO-B		●*	9.525	1.5	1.1	0.22	
16	3	R	16ER30ISO-M	●		●	9.525	1.6	1.2	0.38	16IR30ISO-M	●	●	9.525	1.6	1.2	0.21	
22	3.5	R	22ER35ISO-B		●		12.7	2.3	1.6	0.48								
22	4	R	22ER40ISO-B		●		12.7	2.3	1.6	0.52								

- ●* : The cutting edge position needs re-adjusting for these inserts have different PDY and PDX dimensions (Note: for size 16 inserts only).

- requires the use of dedicated shim.

When using a new AH725 with chipbreaker, the conventional shim may need to be replaced with a new standard shim. Please refer to the page [E069](#).

● : Line up / 5 pieces per package

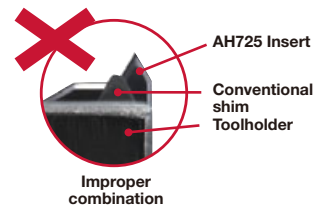

ISO metric (General purpose)

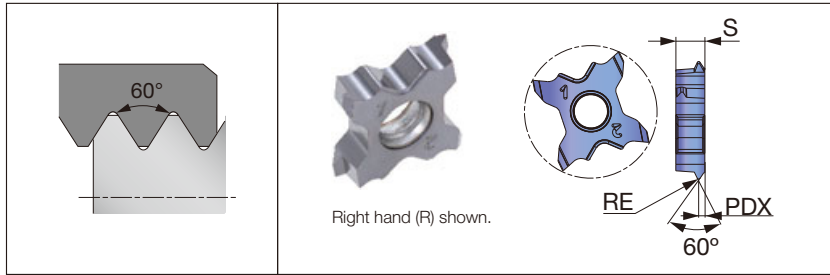

Applicable toolholder

External
STCR/L**-18
STCR/L**18-CHP
JS**-STCL18
C*STCFL**18-CHP
C*STCR/L**18-CHP
QC**STCR/L18 (-Y)
QC**STCR/L18 (-Y)-CHP

Partial-profile insert

Pitch	Hand of cut	Designation	External insert				
			Grade		PDX	RE	S
			Coated				
			SH725	AH725			
0.5	R	TCT18FR-05ISO	●		0.35	0.06	4
0.7	R	TCT18FR-07ISO	●		0.45	0.09	4
0.75	R	TCT18FR-075ISO	●		0.5	0.09	4
0.8	R	TCT18FR-08ISO	●		0.5	0.1	4
1	R	TCT18R-10ISO		●	0.6	0.13	4
1.25	R	TCT18R-125ISO		●	0.7	0.17	4
1.5	R	TCT18R-15ISO		●	0.8	0.2	4

● : Line up / 5 pieces per package

Reference pages: External toolholders → [E041 - E045](#)

Full-profile insert with chipbreaker

Insert size	Pitch (Reference)	TPI	Hand of cut	External insert								Internal insert							
				Designation	Grade			IC	PDX	PDY	RE	Designation	Grade			IC	PDX	PDY	RE
					Coated		Cermet						Coated		Cermet				
					AH8015	AH725	NS9530						AH8015	AH725	NS9530				
16	(1.058)	24	R	16ER24UN-B	●*			9.525	0.8	0.7	0.11								
16	(1.058)	24	R	16ER24UN-M		●		9.525	0.9	0.7	0.13								
16	(1.27)	20	R	16ER20UN-B	●*			9.525	0.9	0.8	0.14	16IR20UN-B	●*			9.525	0.9	0.8	0.06
16	(1.27)	20	R	16ER20UN-M	●		●	9.525	0.9	0.7	0.16	16IR20UN-M		●		9.525	0.9	0.7	0.09
16	(1.411)	18	R	16ER18UN-B	●*			9.525	1	0.8	0.15	16IR18UN-B	●*			9.525	1	0.8	0.08
16	(1.411)	18	R	16ER18UN-M	●		●	9.525	0.9	0.7	0.18	16IR18UN-M	●		●	9.525	0.9	0.7	0.1
16	(1.588)	16	R	16ER16UN-B	●*			9.525	1.1	0.9	0.19	16IR16UN-B	●*			9.525	1.1	0.9	0.09
16	(1.588)	16	R	16ER16UN-M	●		●	9.525	0.9	0.7	0.2	16IR16UN-M		●		9.525	0.9	0.7	0.11
16	(1.814)	14	R	16ER14UN-B	●*			9.525	1.2	1	0.22	16IR14UN-B	●*			9.525	1.2	0.9	0.11
16	(1.814)	14	R	16ER14UN-M	●		●	9.525	1.6	1.2	0.23	16IR14UN-M		●		9.525	1.6	1.2	0.13
16	(1.954)	13	R	16ER13UN-B	●*			9.525	1.3	1	0.24								
16	(2.117)	12	R	16ER12UN-B	●*			9.525	1.4	1.1	0.25	16IR12UN-B	●*			9.525	1.4	1.1	0.12
16	(2.117)	12	R	16ER12UN-M	●		●	9.525	1.6	1.2	0.27	16IR12UN-M	●	●		9.525	1.6	1.2	0.15
16	(3.175)	8	R	16ER8UN-B	●*			9.525	1.6	1.2	0.41	16IR8UN-B	●*			9.525	1.5	1.1	0.2
16	(3.175)	8	R	16ER8UN-M		●		9.525	1.6	1.2	0.4	16IR8UN-M		●		9.525	1.6	1.2	0.22

● : Line up / 5 pieces per package

- ●* : The cutting edge position needs re-adjusting for these inserts have different PDY and PDX dimensions (Note: for size 16 inserts only).
- requires the use of dedicated shim.
When using a new AH725 with chipbreaker, the conventional shim may need to be replaced with a new standard shim. Please refer to the page [E069](#).

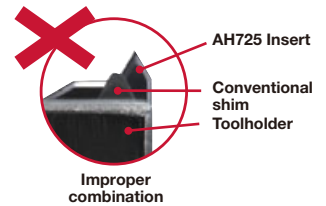

Reference pages: External toolholders → [E036 - E040](#), Internal toolholders → [E054 - E056](#)

NPT (for Pipe)

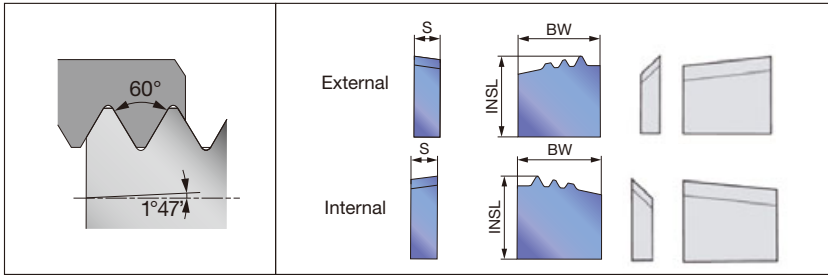

Applicable toolholder

External	Internal
CLVOR-**M...	SI-CLHOR...

Full-profile insert (chaser)

Pitch (Reference)	TPI	Taper		External insert						Internal insert					
				Designation	Grade	BW	INSL	S	Chip breaking attachment	Designation	Grade	BW	INSL	S	Chip breaking attachment
					Coated						AH725				
(2.209)	11.5	1/16	0.75	CR-11.5NPT-4E	●	16	15.7	5.2	CR-8R / 10R-3E / 4E-CB	CR-11.5NPT-4I	●	16	15.7	5.2	CR-8R / 10R-3I / 4I-CB
(3.175)	8	1/16	0.75	CR-8NPT-4E	●	16	15.7	5.2	CR-8R / 10R-3E / 4E-CB	CR-8NPT-4I	●	16	15.7	5.2	CR-8R / 10R-3I / 4I-CB

● : Line up / 5 pieces per package

NPTF (for Pipe)

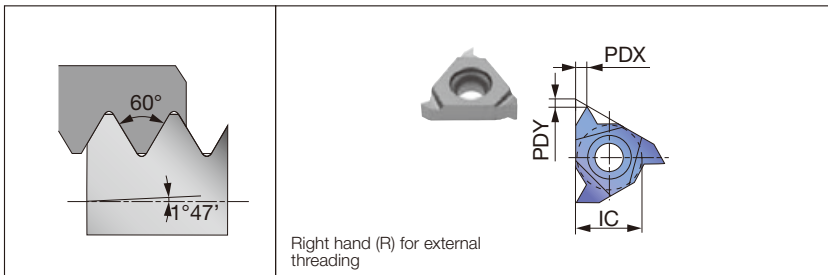

Applicable toolholder

Insert size	External	Internal
16	CER/L**16... (C*CER/L...) JSER**16... JS**SEL16 SER**16-CHP B-SER/L**16 B-CER/L**16 BC-SER/L**16	TSNR/L**16 SNR/L**16... TCNR/L**16... CNR/L**16...

Full-profile insert

Insert size	Pitch (Reference)	TPI	Hand of cut	External insert						Internal insert					
				Designation	Grade	IC	PDX	PDY	RE	Designation	Grade	IC	PDX	PDY	RE
					Coated						AH725				
16	(0.941)	27	R	16ER27NPTF	●	9.525	0.5	1.2	-						
16	(1.411)	18	R	16ER18NPTF	●	9.525	0.9	0.7	-						
16	(1.814)	14	R	16ER14NPTF	●	9.525	1.6	1.2	-	16IR14NPTF	●	9.525	1.6	1.2	-
16	(2.209)	11.5	R	16ER115NPTF	●	9.525	1.6	1.2	-	16IR115NPTF	●	9.525	1.6	1.2	-
16	(3.175)	8	R	16ER8NPTF	●	9.525	1.6	1.2	-	16IR8NPTF	●	9.525	1.6	1.2	-

● : Line up / 5 pieces per package

Reference pages: NPT: External toolholders → **E053**, Internal toolholders → **E066**

NPTF: External toolholders → **E036 - E040**, Internal toolholders → **E054 - E056**

30° Trapezoidal / DIN103 (for Machine parts)

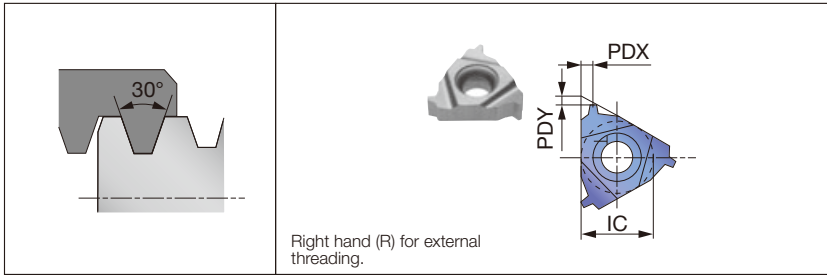

Applicable toolholder

Insert size	External	Internal
16	CER/L**16... (C*CER/L...) JSER**16... JS**SEL16 SER**16-CHP B-SER/L**16 B-CER/L**16 BC-SER/L**16	TSNR/L**16 SNR/L**16... TCNR/L**16... CNR/L**16...
22	CER/L**22... SER**22-CHP	TSNR/L**22 SNR/L**22... TCNR/L**22... CNR/L**22...
27	CER/L**27...	CNR/L**27...

With the special full-profile insert

Insert size	Pitch (Reference)	Hand of cut	External insert					Internal insert						
			Designation	Grade		IC	PDX	PDY	Designation	Grade		IC	PDX	PDY
				Coated	AH725					T313V	Coated			
16	1.5	R	16ER15TR	●		9.525	0.9	0.7	16IR15TR	●		9.525	0.9	0.7
16	2	R	16ER20TR	●	●	9.525	1.6	1.3	16IR20TR	●	●	9.525	1.6	1.3
16	3	R	16ER30TR	●	●	9.525	1.6	1.3	16IR30TR	●	●	9.525	1.6	1.3
22	4	R	22ER40TR	●	●	12.7	2.5	2	22IR40TR	●	●	12.7	2.5	2
22	5	R	22ER50TR	●	●	12.7	2.5	2	22IR50TR	●	●	12.7	2.5	2
27	6	R	27ER60TR	●	●	15.875	3.2	2.5						

● : Line up / 5 pieces per package

Round / DIN405 (for Machine parts)



Applicable toolholder

Insert size	External	Internal
16	CER/L**16... (C*CER/L...) JSER**16... JS**SEL16 SER**16-CHP B-SER/L**16 B-CER/L**16 BC-SER/L**16	TSNR/L**16 SNR/L**16... TCNR/L**16... CNR/L**16...

Full-profile insert

Insert size	Pitch (Reference)	TPI	Hand of cut	External insert					Internal insert								
				Designation	Grade		IC	PDX	PDY	RE	Designation	Grade		IC	PDX	PDY	RE
					Coated	AH725						Coated	AH725				
16	(3.175)	8	R	16ER8RD-B	●		9.525	1.3	1.4	0.75	16IR8RD-B	●		9.525	1.5	1.4	0.94
16	(4.233)	6	R	16ER6RD-B	●		9.525	1.7	1.5	1.01	16IR6RD-B	●		9.525	1.5	1.4	0.94

● : Line up / 5 pieces per package

UNJ (for Aerospace industry)

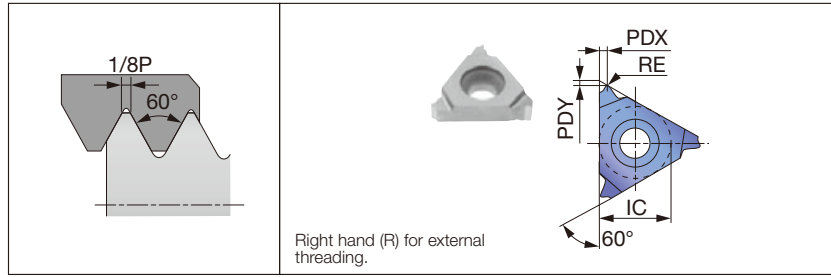

Applicable toolholder

Insert size	External
16	CER/L**16... (C*CER/L...) JSER**16... JS**SEL16 SER**16-CHP B-SER/L**16 B-CER/L**16 BC-SER/L**16

Full-profile insert

Insert size	Pitch (Reference)	TPI	Hand of cut	External insert						
				Designation	Grade		IC	PDX	PDY	RE
					Coated					
AH8015	AH725									
16	(0.794)	32	R	16ER32UNJ	●	●	9.525	0.5	1.2	0.13
16	(0.907)	28	R	16ER28UNJ	●	●	9.525	0.5	1.2	0.15
16	(1.058)	24	R	16ER24UNJ	●	●	9.525	0.9	0.7	0.18
16	(1.27)	20	R	16ER20UNJ	●	●	9.525	0.9	0.7	0.21
16	(1.411)	18	R	16ER18UNJ	●	●	9.525	0.9	0.7	0.24
16	(1.588)	16	R	16ER16UNJ	●	●	9.525	0.9	0.7	0.26
16	(1.814)	14	R	16ER14UNJ	●	●	9.525	1.6	1.2	0.3
16	(2.117)	12	R	16ER12UNJ	●	●	9.525	1.6	1.2	0.35
16	(2.54)	10	R	16ER10UNJ	●	●	9.525	1.6	1.2	0.42
16	(3.175)	8	R	16ER8UNJ	●	●	9.525	1.6	1.2	0.53

● : Line up / 5 pieces per package

MJ (for Aerospace industry)

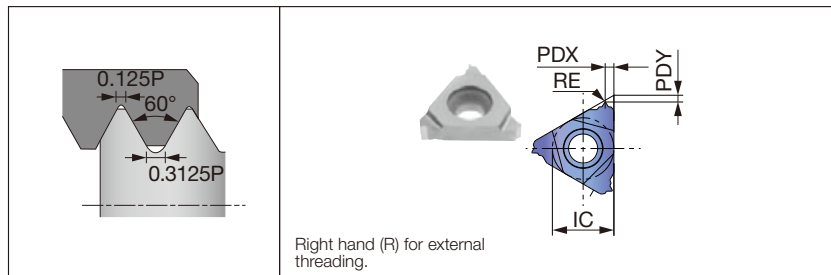

Applicable toolholder

Insert size	Internal
11	SNR/L**11...

Insert size	Pitch (Reference)	Hand of cut	Internal insert							
			Designation	Grade		IC	PDX	PDY	RE	
				Coated						
AH8015										
11	1	R	11IR10MJ	●						

● : Line up / 5 pieces per package

Reference pages: UNJ : External toolholders → **E036 - E040**
MJ : Internal toolholders → **E055**

29° Trapezoidal / ACME (for Machine parts, Pipe)

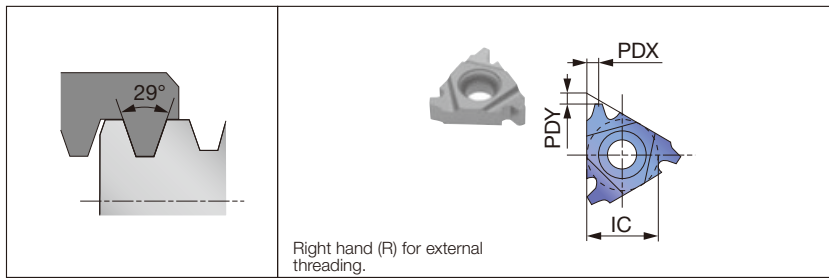

Applicable toolholder

Insert size	External	Internal
16	CER/L**16... (C*CER/L...) JSER**16... JS**SEL16 SER**16-CHP B-SER/L**16 B-CER/L**16 BC-SER/L**16	TSNR/L**16 SNR/L**16... TCNR/L**16... CNR/L**16...
22	CER/L**22... SER**22-CHP	TSNR/L**22 SNR/L**22... TCNR/L**22... CNR/L**22...

With the special full-profile insert

Insert size	Pitch (Reference)	TPI	Hand of cut	External insert						Internal insert					
				Designation	Grade		IC	PDX	PDY	Designation	Grade		IC	PDX	PDY
					Coated						Coated				
					AH725	T313V					AH725	T313V			
16	(2.117)	12	R	16ER12ACME	●		9.525	1.6	1.3	16IR12ACME	●		9.525	1.6	1.3
16	(2.540)	10	R	16ER10ACME	●		9.525	1.6	1.3	16IR10ACME	●		9.525	1.6	1.3
16	(3.175)	8	R	16ER8ACME	●	●	9.525	1.6	1.3	16IR8ACME	●	●	9.525	1.6	1.3
22	(4.233)	6	R	22ER6ACME	●	●	12.7	2.5	2	22IR6ACME	●	●	12.7	2.5	2
22	(5.080)	5	R	22ER5ACME	●	●	12.7	2.5	2	22IR5ACME	●	●	12.7	2.5	2

● : Line up / 5 pieces per package

29° Trapezoidal / ACME (for Machine parts, Pipe)

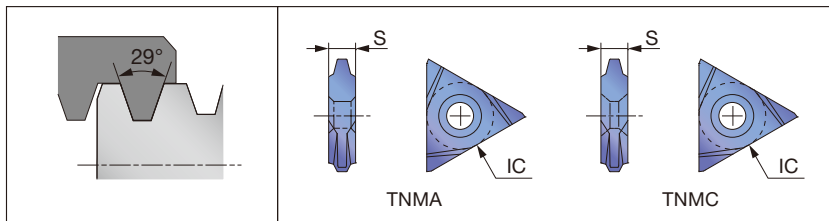

Applicable toolholder

External
MTVOR-**M..
STVOR-**M...

On edge

Pitch	TPI	Taper		External insert			
		mm/mm	TPF	Designation	Grade	IC	S
					Coated		
				AH725			
(1.588)	16	-	-	TNMA43NT16PEXT-PT	●	12.7	4.8
(1.814)	14	-	-	TNMA43NT14PEXT-PT	●	12.7	4.8
(2.117)	12	-	-	TNMA43NT12PEXT-PT	●	12.7	4.8
(2.54)	10	-	-	TNMA43NT10PEXT-PT	●	12.7	4.8
(3.175)	8	-	-	TNMA43NT8PEXT-PT	●	12.7	4.8
(4.233)	6	-	-	TNMA43NT6PEXT-PT	●	12.7	4.8
(5.08)	5	-	-	TNMA54NT5PEXT-PT	●	15.875	6.4
(6.35)	4	-	-	TNMA54NT4PEXT-PT	●	15.875	6.4
(8.47)	3	-	-	TNMA54NT3PEXT-PT	●	15.875	6.4
(1.588)	16	-	-	TNMC43NT16PEXT-PT	●	12.7	4.8
(1.814)	14	-	-	TNMC43NT14PEXT-PT	●	12.7	4.8
(2.117)	12	-	-	TNMC43NT12PEXT-PT	●	12.7	4.8
(2.54)	10	-	-	TNMC43NT10PEXT-PT	●	12.7	4.8
(3.175)	8	-	-	TNMC43NT8PEXT-PT	●	12.7	4.8
(4.233)	6	-	-	TNMC43NT6PEXT-PT	●	12.7	4.8
(5.08)	5	-	-	TNMC54NT5PEXT-PT	●	15.875	6.4
(6.35)	4	-	-	TNMC54NT4PEXT-PT	●	15.875	6.4
(8.47)	3	-	-	TNMC54NT3PEXT-PT	●	15.875	6.4

● : Line up / 10 pieces per package

Reference pages: 29° Trapezoidal With the special full-profile insert : External toolholders → **E036 - E040**, Internal toolholders → **E054 - E056**
 29° Trapezoidal On edge : External toolholders → **E052**

29° Trapezoidal/ STUB ACME (for Machine parts, Pipe)

On edge

Pitch (Reference)	TPI	Taper		External insert				
		mm/mm	TPF	Designation	Grade		IC	S
					Coated	AH725		
(1.588)	16	-	-	TNMA43NT16PSTUBE-PT	●	12.7	4.8	
(1.814)	14	-	-	TNMA43NT14PSTUBE-PT	●	12.7	4.8	
(2.117)	12	-	-	TNMA43NT12PSTUBE-PT	●	12.7	4.8	
(2.54)	10	-	-	TNMA43NT10PSTUBE-PT	●	12.7	4.8	
(3.175)	8	-	-	TNMA43NT8PSTUBE-PT	●	12.7	4.8	
(4.233)	6	-	-	TNMA43NT6PSTUBE-PT	●	12.7	4.8	
(5.08)	5	-	-	TNMA54NT5PSTUBE-PT	●	15.875	6.4	
(6.35)	4	-	-	TNMA54NT4PSTUBE-PT	●	15.875	6.4	
(8.47)	3	-	-	TNMA54NT3PSTUBE-PT	●	15.875	6.4	
(1.588)	16	-	-	TNMC43NT16PSTUBE-PT	●	12.7	4.8	
(1.814)	14	-	-	TNMC43NT14PSTUBE-PT	●	12.7	4.8	
(2.117)	12	-	-	TNMC43NT12PSTUBE-PT	●	12.7	4.8	
(2.54)	10	-	-	TNMC43NT10PSTUBE-PT	●	12.7	4.8	
(3.175)	8	-	-	TNMC43NT8PSTUBE-PT	●	12.7	4.8	
(4.233)	6	-	-	TNMC43NT6PSTUBE-PT	●	12.7	4.8	
(5.08)	5	-	-	TNMC54NT5PSTUBE-PT	●	15.875	6.4	
(6.35)	4	-	-	TNMC54NT4PSTUBE-PT	●	15.875	6.4	
(8.47)	3	-	-	TNMC54NT3PSTUBE-PT	●	15.875	6.4	

Applicable toolholder

External
MTVOR-**M..
STVOR-**M...

Note: ACME and STUB ACME can cut crest radius. Crest flat of ACME and STUB ACME need to be cut by another tool.

● : Line up / 10 pieces per package

API Round (for Energy industry)

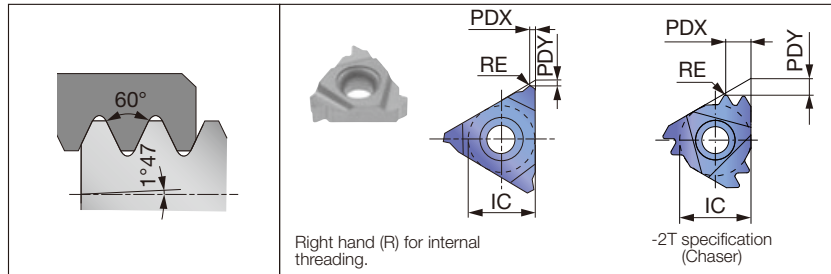

Applicable toolholder

Insert size	External	Internal
16	CER/L**16... (C*CER/L...) JSER**16... JS**SEL16 SER**16-CHP B-SER/L**16 B-CER/L**16 BC-SER/L**16	TSNR/L**16 SNR/L**16... TCNR/L**16... CNR/L**16...
22	CER/L**22... SER**22-CHP	TSNR/L**22 SNR/L**22... TCNR/L**22... CNR/L**22...

Full-profile insert

Insert size	Pitch (Reference)	TPI	Hand of cut	External insert							Internal insert							
				Designation	Grade		IC	PDX	PDY	RE	Designation	Grade			IC	PDX	PDY	RE
					Coated	AH725						T313V	Coated	AH8015				
16	(2.54)	10	R	16ER10RAPI	●		9.525	1.6	1.2	0.36	16IR10RAPI	●	●	9.525	1.6	1.2	0.36	
16	(3.175)	8	R	16ER8RAPI	●		9.525	1.6	1.2	0.43	16IR8RAPI	●	●	9.525	1.6	1.2	0.43	
22	(3.175)	8	R								22IR8RAPI-2T	●		12.7	4.5	3	0.43	

● : Line up / 5 pieces per package

Full-profile insert with chipbreaker

Insert size	Pitch (Reference)	TPI	Hand of cut	External insert							Internal insert							
				Designation	Grade		IC	PDX	PDY	RE	Designation	Grade			IC	PDX	PDY	RE
					Coated	AH725							Coated	AH725				
16	(2.54)	10	R	16ER10RD-CB	●		9.525	1.2	1.5	0.36	16IR10RD-CB	●		9.525	1.2	1.5	0.36	
16	(3.175)	8	R	16ER8RD-CB	●		9.525	1.3	1.5	0.43	16IR8RD-CB	●		9.525	1.3	1.5	0.43	

● : Line up / 10 pieces per package

Reference pages: 29° Trapezoidal : External toolholders → E052

API Round : External toolholders → E036 - E040, Internal toolholders → E054 - E056

API Round (for Energy)

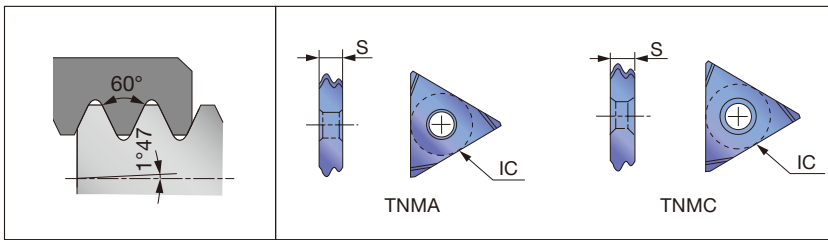

Applicable toolholder

External	Internal
MTVOR-**M..	HS**-MTHOR...
STVOR-**M...	

On edge

Pitch (Reference)	TPI	Taper		External insert				Internal insert			
		mm/mm	TPF	Designation	Grade	IC	S	Designation	Grade	IC	S
					Coated				Coated		
(2.54)	10	1/16	0.75	TNMA4310RDEXT	●	12.7	4.8	TNMA4310RDINT	●	12.7	4.8
(3.175)	8	1/16	0.75	TNMA438RDEXT	●	12.7	4.8	TNMA438RDINT	●	12.7	4.8
(2.54)	10	1/16	0.75	TNMC4310RDEXT	●	12.7	4.8	TNMC4310RDINT	●	12.7	4.8
(3.175)	8	1/16	0.75	TNMC438RDEXT	●	12.7	4.8	TNMC438RDINT	●	12.7	4.8

● : Line up / 10 pieces per package

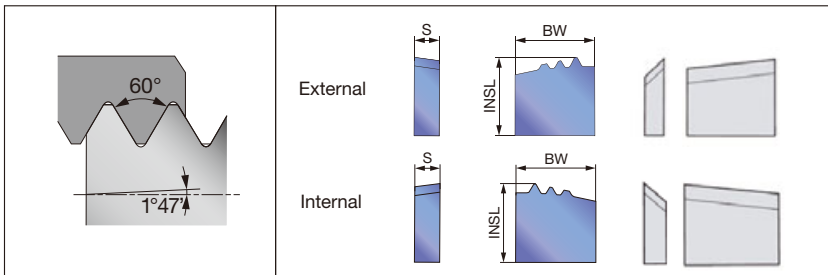

Applicable toolholder

External	Internal
CLVOR-**M...	SI-CLHOR...

Full-profile insert (chaser)

Pitch (Reference)	TPI	Taper		External insert						Internal insert					
		mm/mm	TPF	Designation	Grade	BW	INSL	S	Chip breaking attachment	Designation	Grade	BW	INSL	S	Chip breaking attachment
					Coated						Coated				
(3.175)	8	1/16	0.75	CR-8R-3E	●	16	15	5.2	CR-8R / 10R-3E / 4E-CB	CR-8R-3I	●	16	15	5.2	CR-8R / 10R-3I / 4I-CB
(2.54)	10	1/16	0.75	CR-10R-3E	●	16	15.9	5.2	CR-8R / 10R-3E / 4E-CB	CR-10R-3I	●	16	15.9	5.2	CR-8R / 10R-3I / 4I-CB

● : Line up / 10 pieces per package

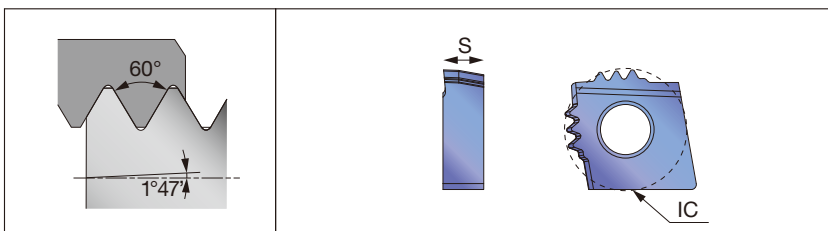

Full-profile insert (chaser)

Pitch (Reference)	TPI	Taper		External insert			
		mm/mm	TPF	Designation	Grade	IC	S
					Coated		
(2.54)	10	1/16	0.75	CNGA-10R-3E	●	19.05	6.4
(3.175)	8	1/16	0.75	CNGA-8R-3E	●	19.05	6.4

Note: Toolholders need to be customized for these types of inserts.

● : Line up / 10 pieces per package

Reference pages: API Round On edge : External toolholders → **E052**, Internal toolholders → **E065**

API Round Full-profile insert : External toolholders → **E053**, Internal toolholders → **E066**

API Round (for Energy industry) For tool-rotating machines

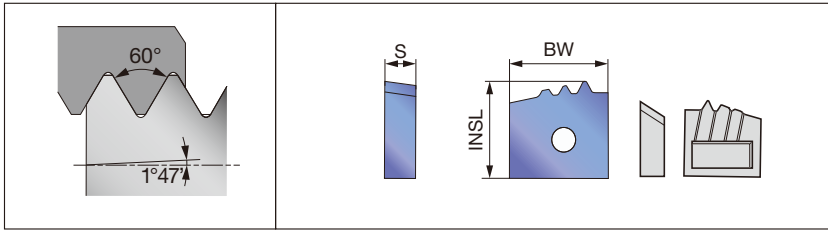

Full-profile insert (chaser)

Pitch (Reference)	TPI	Taper		Designation	External insert			Chip breaking attachment	
		mm/mm	TPF		Grade	BW	INSL		S
					Coated				
(3.175)	8	1/16	0.75	CR-8R-3E#1	AH725	16	14.7	5.2	TD39318R-1-CBW/CAVITY
(3.175)	8	1/16	0.75	CR-8R-3E#2	AH725	16	14.9	5.2	TD39328R-2-CBW/CAVITY
(3.175)	8	1/16	0.75	CR-8R-3E#3	AH725	16	15	5.2	TD39338R-3-CBW/CAVITY

Note: Toolholders need to be customized for these types of inserts.

● : Line up / 10 pieces per package

API Buttress (for Energy industry)

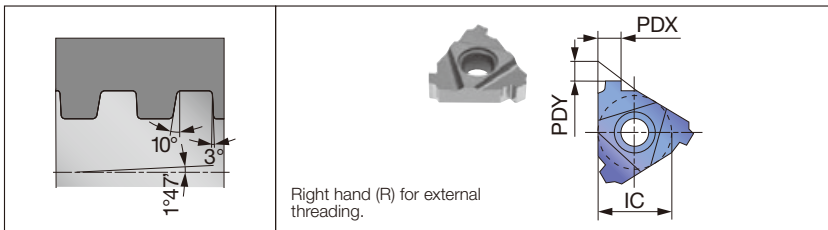

Applicable toolholder

Insert size	External	Internal
22	CER/L**22... SER**22-CHP	TSNR/L**22... SNR/L**22... TCNR/L**22... CNR/L**22...

Full-profile insert

Insert size	Pitch (Reference)	TPI	Hand of cut	External insert			Internal insert						
				Designation	Grade	IC	PDX	PDY	Designation	Grade	IC	PDX	PDY
					Coated					AH725			
22	(5.08)	5	R	22ER5BAPI	AH725	12.7	3.72	2.2	22IR5BAPI	AH725	12.7	3.45	2.2

● : Line up / 5 pieces per package

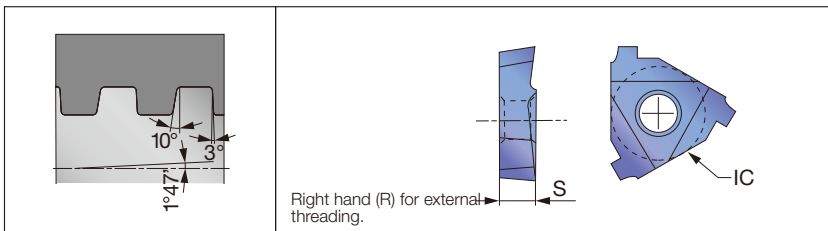

Applicable toolholder

External	Internal
MTVNR**M5	HS**-LNFR...

Full-profile insert (single side)

Pitch (Reference)	TPI	Taper		Designation	External insert			Internal insert			
		mm/mm	TPF		Grade	IC	S	Designation	Grade	IC	S
					Coated				AH725		
(5.08)	5	1/16	0.75	L535B75EXT-FC	AH725	15.875	4.8	L535B75INT-FC	AH725	15.875	4.8
(5.08)	5	1/12	1	L535B1EXT-FC	AH725	15.875	4.8	L535B1INT-FC	AH725	15.875	4.8

● : Line up / 10 pieces per package

Reference pages: API Buttress Full-profile insert : External toolholders → **E036, E038**, Internal toolholders → **E055 - E056**
API Buttress Full-profile insert (single side) : External toolholders → **E051**, Internal toolholders → **E064**

API Buttress (for Energy industry)

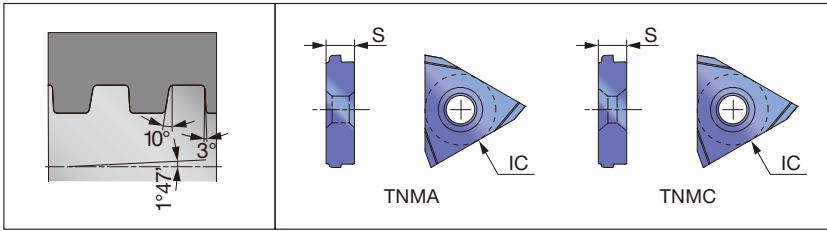

Applicable toolholder

External	Internal
MTVOR-**M...	HS**-MTHOR...
STVOR-**M...	

On edge

Pitch (Reference)	TPI	Taper		External insert				Internal insert			
		mm/mm	TPF	Designation	Grade	IC	S	Designation	Grade	IC	S
					Coated				Coated		
(5.08)	5	1/12	1	TNMA545B1EXT-FC	AH725	15.875	6.4	TNMA545B1INT-FC	AH725	15.875	6.4
(5.08)	5	1/16	0.75	TNMA545B75EXT-FC	AH725	15.875	6.4	TNMA545B75INT-FC	AH725	15.875	6.4
(5.08)	5	1/12	1	TNMC545B1EXT-FC	AH725	15.875	6.4	TNMC545B1INT-FC	AH725	15.875	6.4
(5.08)	5	1/16	0.75	TNMC545B75EXT-FC	AH725	15.875	6.4	TNMC545B75INT-FC	AH725	15.875	6.4

● : Line up / 10 pieces per package

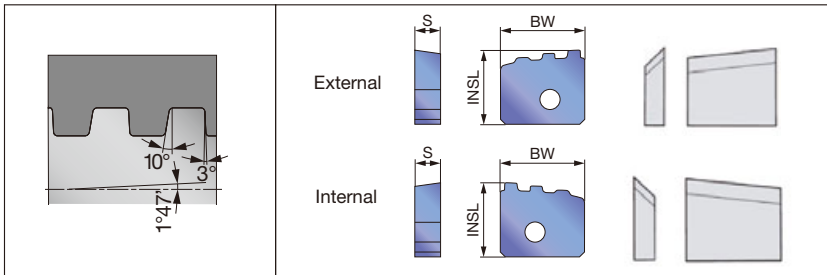

Applicable toolholder

External	Internal
CLVOR-**M...	SI-CLHOR...

Full-profile insert (chaser)

Pitch (Reference)	TPI	Taper		External insert					Internal insert						
		mm/mm	TPF	Designation	Grade	BW	INSL	S	Chip breaking attachment	Designation	Grade	BW	INSL	S	Chip breaking attachment
					Coated						Coated				
(5.08)	5	1/16	0.75	CR-5B75-4E	AH725	20.4	15.9	5.1	CR-5B75 / 5B1-4E-CB	CR-5B75-3I	AH725	16	15.8	5.2	CR-8R / 10R-3I / 4I-CB

● : Line up / 10 pieces per package

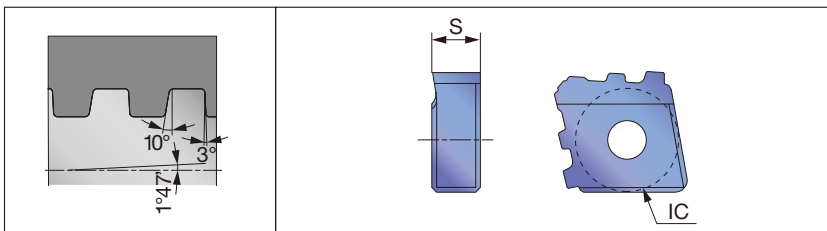

Full-profile insert (chaser)

Pitch (Reference)	TPI	Taper		External insert			
		mm/mm	TPF	Designation	Grade	IC	S
					Coated		
(5.08)	5	1/16	0.75	CNGA-5B75-3E	AH725	19.05	6.4

Note: Toolholders need to be customized for these types of inserts.

● : Line up / 10 pieces per package

Reference pages: API Buttress On edge : External toolholders → E052, Internal toolholders → E065

API Buttress Full-profile insert : External toolholders → E053, Internal toolholders → E066

API Buttress (for Energy industry)

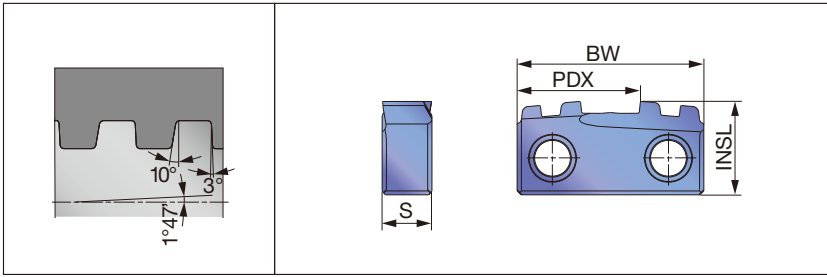

Thread form

60°

55°

M

(Metric)

UN

(Unified)

W

(Whitworth)

BSPT

(R, PT)

NPT

NPTF

TR

(Metric, 30° Trapezoidal)

Round

(DIN405)

UNJ

MJ

ACME

(29° Trapezoidal)

STUB ACME

(29° Trapezoidal)

API Round

API Buttress

API Rotary Shoulder Connection

Full-profile insert

Insert size	Pitch (Reference)	TPI	Hand of cut	Internal insert					
				Designation	Grade	BW	INSL	PDX	S
					Coated				
					T05HP				
22	(5.08)	5	R	CR-5B75-2I-W24	●	24	12	15.85	6.4

Note: Toolholders need to be customized for these types of inserts.

● : Line up / 10 pieces per package

API Buttress (for Energy industry)

For tool-rotating machines

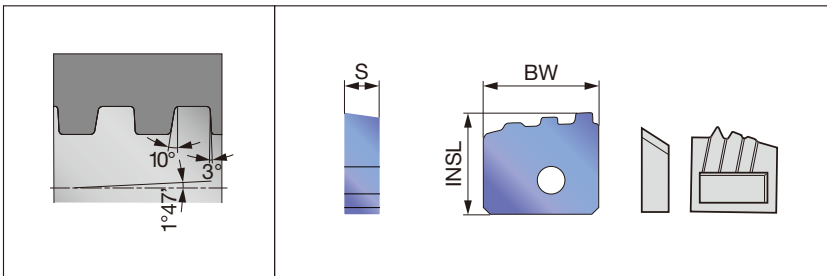

Full-profile insert (chaser)

Pitch (Reference)	TPI	Taper		Designation	Grade	BW	INSL	S	RE	Chip breaking attachment
		mm/mm	TPF		Coated					
					AH725					
(5.08)	5	1/16	0.75	CR-5B75-3E#1	●	17	14.6	5.2		TD46015B75-1-CBW/CAVITY
(5.08)	5	1/16	0.75	CR-5B75-3E#2	●	17	14.8	5.2		TD46025B75-2-CBW/CAVITY
(5.08)	5	1/16	0.75	CR-5B75-3E#3	●	17	15	5.2		TD46035B75-3-CBW/CAVITY

Note: Toolholders need to be customized for these types of inserts.

● : Line up / 10 pieces per package

API Rotary shoulder connection (for Energy industry)

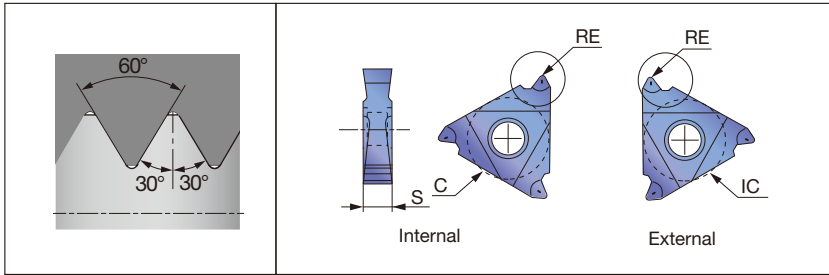

Applicable toolholder

External	Internal
MTVNR-3232M54	HS**-LNFR-54API

Full-profile insert (Double side)

Pitch (Reference)	TPI	Connection	Taper		Designation	Grade	IC	S	RE
			mm/mm	TPF		Coated			
						AH725			
(6.35)	4	V-0.038R	1/6	2	LDS54428FT-CB#1	●	15.875	6.4	0.97
(6.35)	4	V-0.038R	1/4	3	LDS54438FT-CB#2	●	15.875	6.4	0.97
(6.35)	4	V-0.050	1/6	2	LDS54425FT-CB#3	●	15.875	6.4	0.64
(6.35)	4	V-0.050	1/4	3	LDS54435FT-CB#4	●	15.875	6.4	0.64
(5.08)	5	V-0.040	1/4	3	LDS54530FT-CB#5	●	15.875	6.4	0.51

● : Line up / 10 pieces per package

External threading toolholder, alternative clamping of screw-on or clamp-on only for DT type

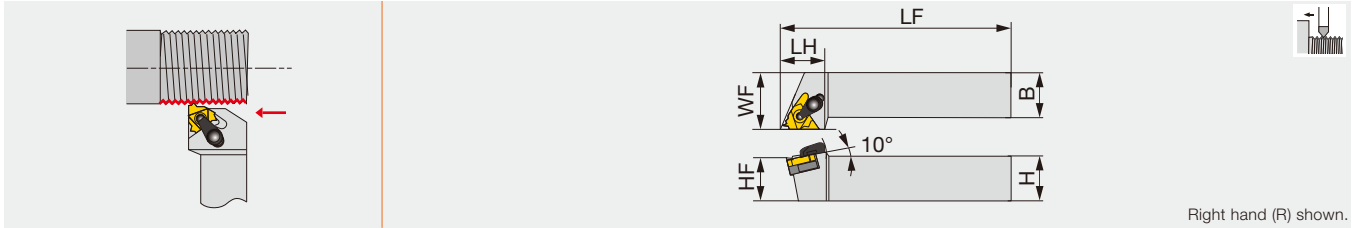

Right hand (R) shown.

Designation	H	B	LF	LH	HF	WF	Insert
CER/L1212H16DT	12	12	100	24	12	16	16ER/L...
CER/L1616H16DT	16	16	100	24	16	20	16ER/L...
CER/L2020K16DT	20	20	125	24	20	25	16ER/L...
CER/L2525M16DT	25	25	150	28	25	32	16ER/L...
CER/L2525M22DT	25	25	150	31.3	25	32	22ER/L...
CER3232P16T	32	32	170	32	32	40	16ER...
CER3232P22T	32	32	170	32	32	40	22ER...
CER2525M27T	25	25	150	34	25	32	27ER...
CER3232P27T	32	32	170	34	32	40	27ER...

Note: A clamp set consists of a clamp and a clamping screw. A shim set consists of a shim and a shim screw to secure the shim to the shank. Standard shims can be used on both right- and left-hand toolholders. Please use either of the sides depending on the tool hand. When using DT type, please remove either the clamp set or the insert clamping screw.

C-CER/L

External threading toolholder, alternative clamping of screw-on or clamp-on

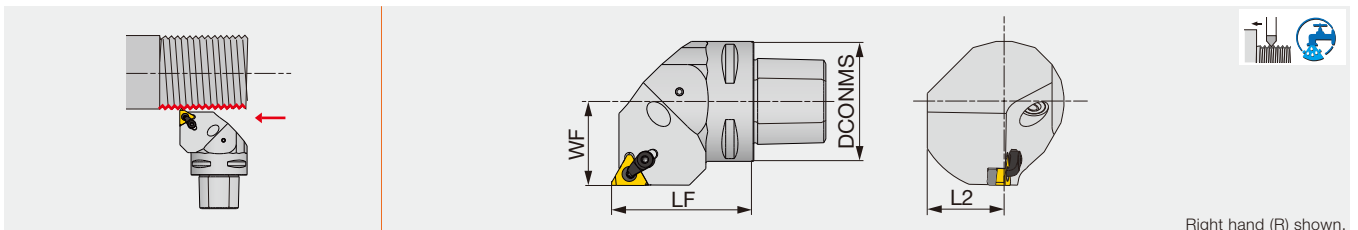

Right hand (R) shown.

Designation	DCONMS	LF	L2	WF	Insert
C3CER/L22040-16ERN ⁽²⁾	32	40	20	22	16ER/L...
C4CER/L27050-16ERN ⁽²⁾	40	50	25	27	16ER/L...
C5CER/L35060-16ER ⁽¹⁾	50	60	32	35	16ER/L...
C5CER/L35060-16ERN ⁽²⁾	50	60	32	35	16ER/L...
C6CER/L45065-16ER ⁽¹⁾	63	65	41	45	16ER/L...
C6CER/L45065-16ERN ⁽²⁾	63	65	41	45	16ER/L...

(1) Applicable for 3 MPa coolant (2) Applicable for 7 MPa coolant

SPARE PARTS

Designation	Clamp set	Clamping screw	Coolant parts	Shim screw	Shim	Shim set	Wrench 1	Wrench 2	Wrench 3
CER/L*16DT	CSP16	CSTB-3.5ST	-	DTS5-3.5	A16-1DT	-	P-3.5	T-15F	-
CER/L2525M22DT	CSP22	CSTB-4ST	-	DTS6-4	GX22-1DT	-	P-4	T-15F	T-20F
CER3232P16T	CSP16	-	-	-	-	A16-1	-	T-15F	-
CER3232P22T	CSP22	-	-	-	-	NXE22-1	-	T-20F	-
CER*27T	CSP27	-	-	-	-	NXE27-1	P-4	-	-
C3CE*22040-16ERN, C4CE*27050-16ERN	CSP16	CSTB-3.5ST	SATZ-M8X1-M3	DTS5-3.5	A16-1DT	-	P-3.5	T-15F	-
C5CE*35060-16ER, C6CE*45065-16ER	CSP16	CSTB-3.5ST	EZ104	DTS5-3.5	A16-1DT	-	P-3.5	T-15F	-
C5CE*35060-16ERN, C6CE*45065-16ERN	CSP16	CSTB-3.5ST	SATZ-M10X1-M5	DTS5-3.5	A16-1DT	-	P-3.5	T-15F	-

Reference pages: Inserts → **E010 - E011, E015, E017 - E030, E032**

External threading toolholder, alternative clamping of screw-on or clamp-on

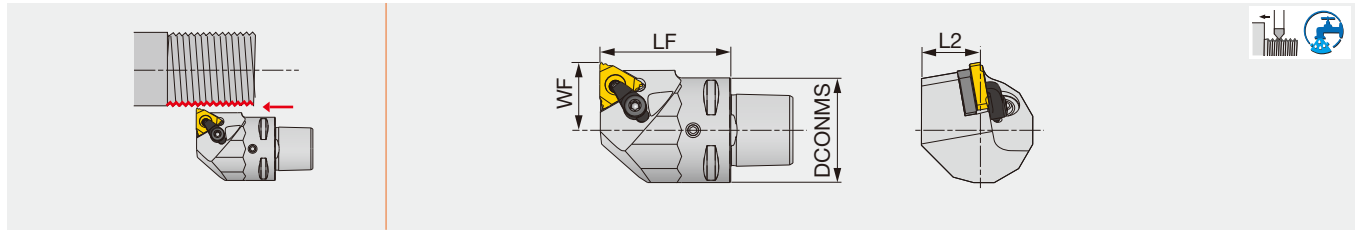

Designation	DCONMS	LF	L2	WF	Insert
C3CEL22040-16ERN-B	32	40	18	22	16ER...

Applicable for 7 MPa coolant
Cannot be used for boring

C-CEL-ERB-CHP

Tube connection

External threading toolholder, alternative clamping of screw-on or clamp-on, with high pressure coolant capability

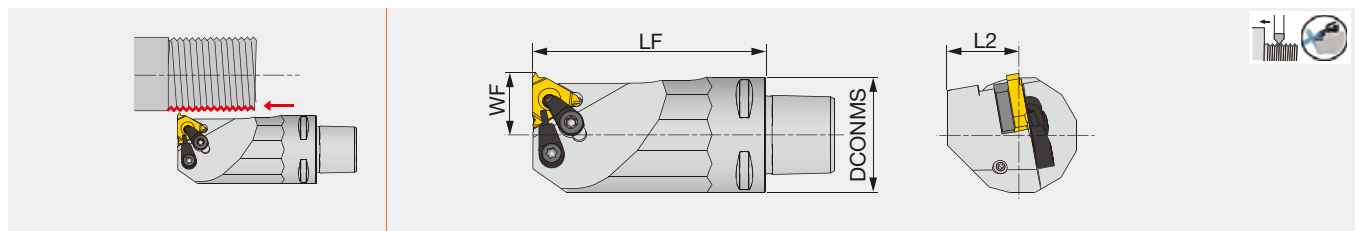

Designation	DCONMS	LF	L2	WF	Insert
C3CEL18065-16ERB-CHP	32	65	20	18	16ER...

Applicable for 14 MPa coolant
Cannot be used for boring

SPARE PARTS

Designation	Shim	Shim screw	Clamping screw	Clamping screw	Wrench 1	Wrench 2	Coolant parts	Coolant unit
C3CEL22040-16ERN-B	A16-1DT	DTS5-3.5	CSTB-3.5ST	CSP16	T-15F	P-3.5	SATZ-M8X1-M3	-
C3CEL18065-16ERB-CHP	A16-1DT	DTS5-3.5	CSTB-3.5ST	CSP16	T-15F	P-3.5	-	S-CU-CHP



TUNGTHREAD

JSE2R16-CHP

External threading toolholder with DirectTungJet connection, with high pressure coolant capability

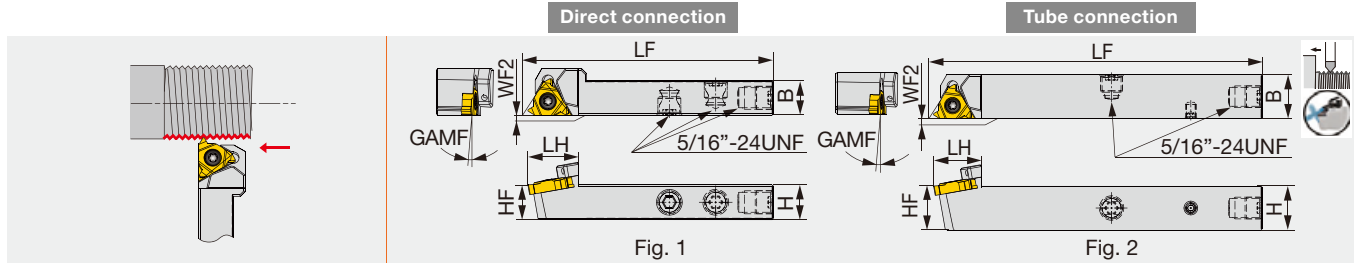

Designation	H	B	LF	LH	HF	WF2	GAMF	Fig.	Insert
JSE2R1212F16-CHP	12	12	85	19	12	0	1°	1	16ER...
JSE2R1212X16-CHP	12	12	120	19	12	0	1°	2	16ER...
JSE2R1616X16-CHP	16	16	120	19	16	0	1°	2	16ER...

SER-X-CHP-MC

Direct connection

Screw-on external threading toolholders-High-pressure coolant capability with tube and direct connection

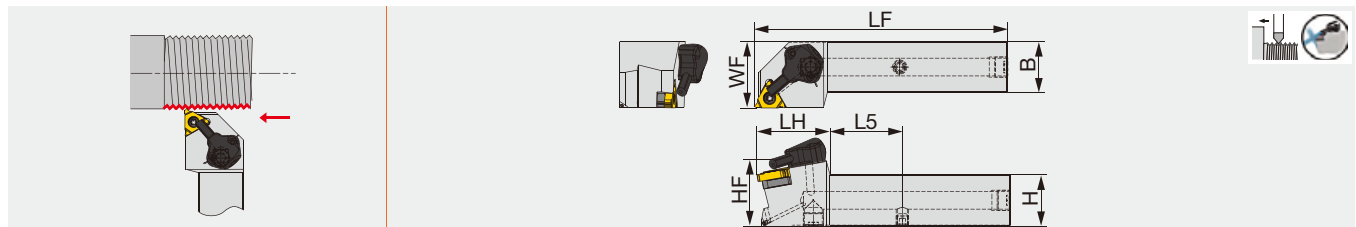

Designation	H	B	LF	LH	HF	WF	L5	Insert
SER2020X16-CHP-MC	20	20	107	36	20	25	27.9	16ER...
SER2525X16-CHP-MC	25	25	122	36	25	32	33.75	16ER...
SER2525X22-CHP-MC	25	25	122	36	25	32	33.75	22ER...

SPARE PARTS

Designation	Clamping screw	Wrench	Shim screw	Shim	Coolant unit	Coolant plug	Wrench
JSE2R**16-CHP	CSTB-3.5	-	-	-	-	-	-
SER**X16-CHP-MC	CSTB-3.5ST	T-15F	DTS5-3.5	A16-1DT	CU-V-CHP	PLUGG1/8-6.5TL360	P-3.5
SER**X22-CHP-MC	CSTB-4ST	T-15F	DTS6-4	GX22-1DT	CU-CW-CHP	PLUGG1/8-6.5TL360	P-4

No need for coolant tube setup.

Eliminates chip entanglement on tubes and streamlines tool replacement.

Coolant is supplied from the tool post directly to the tools

Internal thread
Optional connection with
external coolant tube

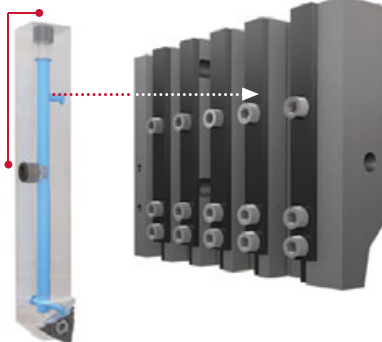

Detailed view of the coolant
flow after connection

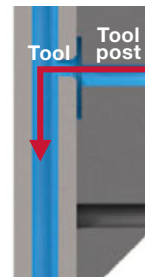

Reference pages: Inserts → [E010 - E011](#), [E015](#), [E017 - E030](#), [E032](#)

B-S/CER/L

External threading toolholder for Swiss lathes

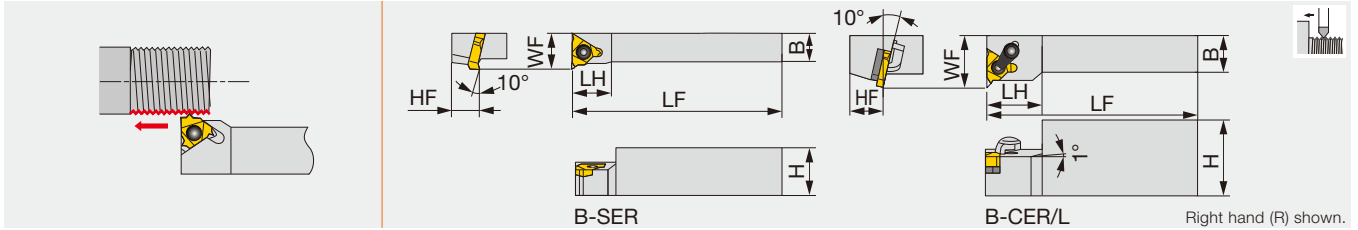

Designation	H	B	LF	LH	HF	WF	Insert
B-SER10H16	20	10	100	15	10	16	16ER...
B-SER12K16	24	12	125	18	12	18	16ER...
B-CER/L16M16	32	16	150	24	16	22	16ER/L...

JS-SEL16

External threading toolholder for Swiss lathes

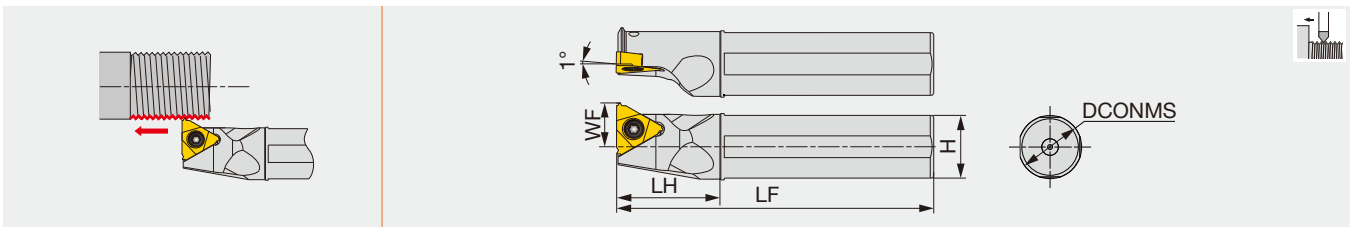

Designation	DCONMS	H	LF	LH	WF	Insert
JS16F-SEL16	16	15	85	25	11	16ER...
JS19G-SEL16	19.05	18	90	30	12.5	16ER...
JS19X-SEL16	19.05	18	120	30	12.5	16ER...
JS20G-SEL16	20	19	90	30	13	16ER...
JS20X-SEL16	20	19	120	30	13	16ER...
JS25H-SEL16	25	24	100	30	15.5	16ER...
JS254X-SEL16	25.4	24	120	30	15.7	16ER...

Note: Use the right-hand insert (16ER...) for a left-hand holder (JS***-SEL...).

SPARE PARTS

Designation	Clamp set	Shim set	Clamping screw	Wrench
B-SER**16	-	-	CSTB-3.5	T-15F
B-CER/L16M16	CSP16	A16-1	-	T-15F
JS***-SEL16	-	-	CSTB-3.5	T-15F

Reference pages: Inserts → **E010 - E011, E015, E017 - E030**

External threading toolholder for multi-functional Swiss lathes

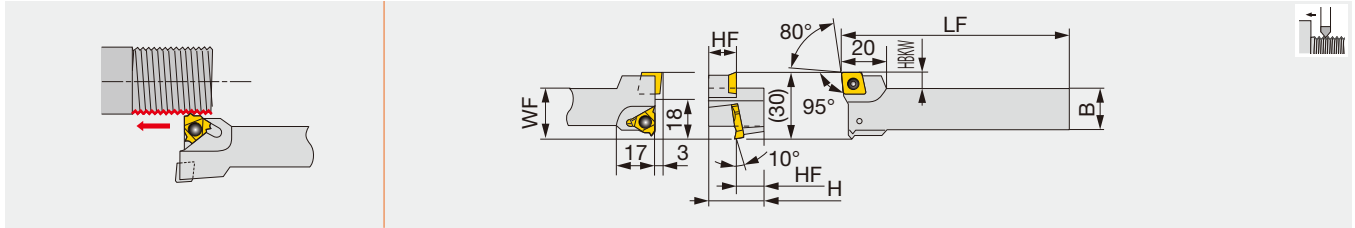

Designation	H	B	LF	HF	WF	HBKW	Insert
BC-SER12K16	24	16	125	12	23	7	16ER..., CC*T09T3...

SER

Screw-on external threading toolholders

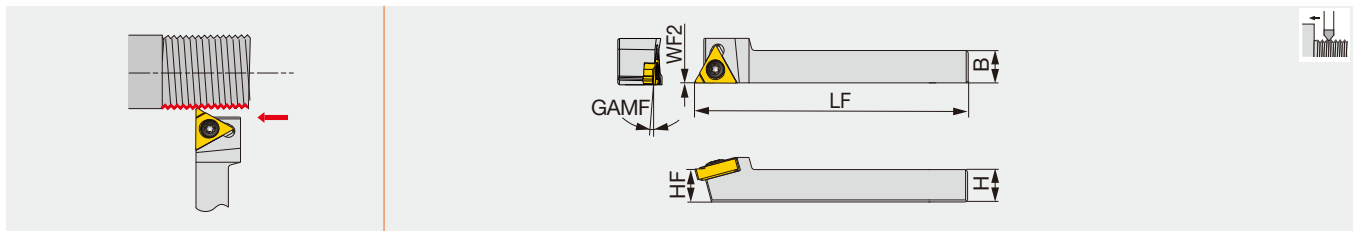

Designation	H	B	LF	HF	WF2	GAMF	Insert
SER0808H11	8	8	100	8	0	1.5°	11ER...
SER1010H11	10	10	100	10	0	1.5°	11ER...

SPARE PARTS



Designation	Clamping screw	Wrench
BC-SER12K16	CSTB-3.5	T-15F
SER**H11	SR M2.6-L6.7-S11	T-8/5

External grooving and threading toolholder

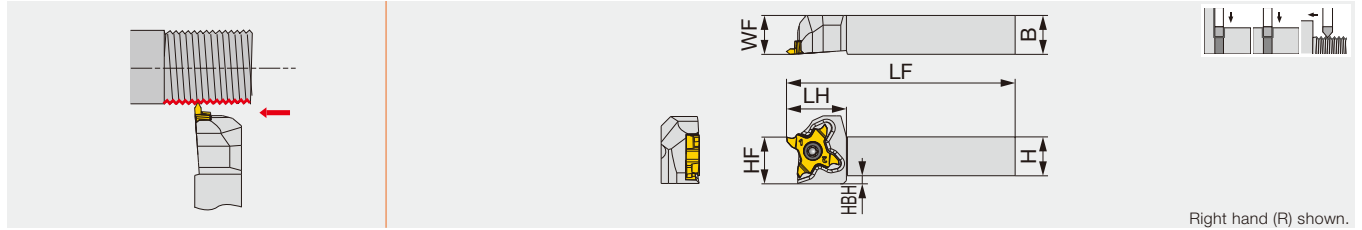

Right hand (R) shown.

Designation	H	B	LF	LH	HF	WF	HBH	Insert	Torque*
STCR/L1010X18	10	10	120	18.5	10	10	4.5	TCT18...	1.2
STCR/L1212F18	12	12	85	18.5	12	12	2.5	TCT18...	1.2
STCR/L1212X18	12	12	120	18.5	12	12	2.5	TCT18...	1.2
STCR/L1616X18	16	16	120	18.5	16	16	-	TCT18...	1.2
STCR/L2020H18	20	20	100	18.5	20	20	-	TCT18...	1.2
STCR/L2020X18	20	20	120	23	20	25	-	TCT18...	1.2
STCR/L2525Z18	25	25	135	23	25	30	-	TCT18...	1.2

Torque* : Recommended clamping torque (N·m)

Note: Use the right-hand insert (TC*18R...) for a right-hand holder (STCR...); the left-hand insert (TC*18L...) for a left-hand holder (STCL...).

STCR/L-18-CHP

Direct connection

External grooving and threading toolholder, with high pressure coolant capability

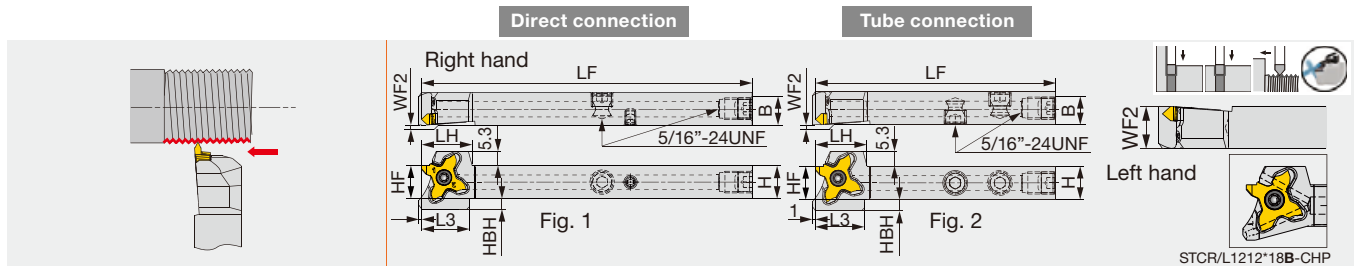

STCR/L1212*18B-CHP

Designation	H	B	LF	LH	HBL	HF	WF2**	HBH	Fig.	Insert	Torque*
STCR/L1012H18-CHP ⁽¹⁾	10	12	100	17.1	10	17.1	0/12	4	1	TCT18...	1.2
STCR/L1212F18B-CHP	12	12	120	18.5	17.5	12	0/12	4	2	TCT18...	1.2
STCR/L1212X18B-CHP ⁽¹⁾	12	12	120	18.5	17.5	12	0/12	4	1	TCT18...	1.2
STCR/L1616X18-CHP ⁽¹⁾	16	16	120	18.5	-	16	0/16	-	1	TCT18...	1.2

Torque* : Recommended clamping torque (N·m)

WF2** : The first value before "/" indicates the WF2 for the right-hand holder and the second value after "/" for the left-hand holder.

(1) Compatible to the direct internal coolant supply system without the use of external coolant hose.

Note: This toolholder can be used with threading and grooving inserts.

Use the right-hand insert (TC*18R...) for a right-hand holder (STCR...); the left-hand insert (TC*18L...) for a left-hand holder (STCL...).

SPARE PARTS



Designation	Clamping screw	Wrench
STCL..., STCL**18-CHP	CSTC-4L100DR	T-1008/5
STCR..., STCR**18-CHP	CSTC-4L100DL	T-1008/5

External threading with high pressure coolant capability

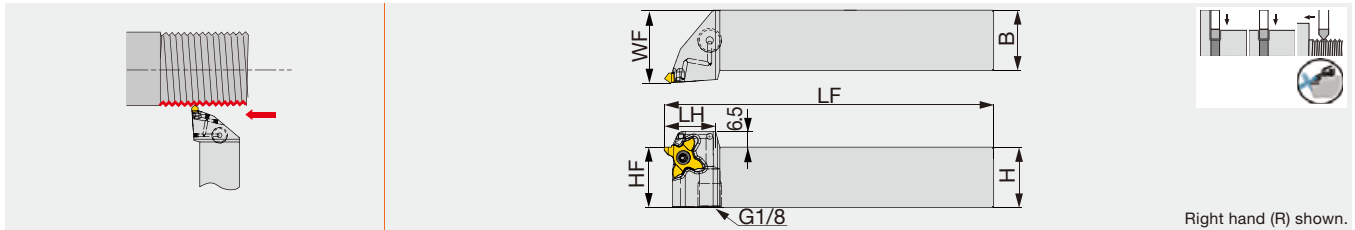

Designation	H	B	LF	LH	HBL	HF	WF	HBH	Insert	Torque*
STCR/L2020X18-CHP	20	20	120	23	-	20	25	-	TC*18...	1.2
STCR/L2525Z18-CHP	25	25	135	23	-	25	30	-	TC*18...	1.2

Torque* : Recommended clamping torque (N·m)

Note: Use the right-hand insert (TC*18R...) for a right-hand toolholders (STCR...); the left-hand insert (TC*18L...) for a left-hand holder (STCL...).

JS-STCL18

External grooving and threading toolholder with round shank

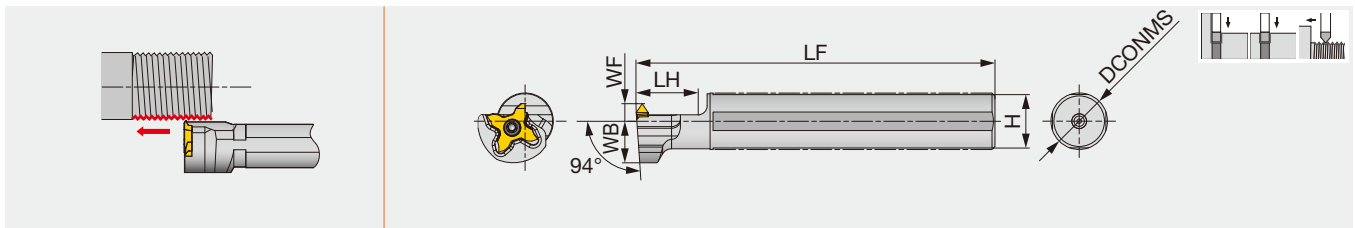

Designation	DCONMS	LF	LH	H	WB	WF	Insert	Torque*
JS14H-STCL18	14	100	20	13	14	6	TCT18R...	1.2
JS159F-STCL18	15.875	85	20	15	14	6	TCT18R...	1.2
JS16F-STCL18	16	85	20	15	14	6	TCT18R...	1.2
JS19G-STCL18	19.05	90	20	18	14	6	TCT18R...	1.2
JS19X-STCL18	19.05	120	20	18	14	6	TCT18R...	1.2
JS20G-STCL18	20	90	20	19	14	6	TCT18R...	1.2
JS20X-STCL18	20	120	20	19	14	6	TCT18R...	1.2
JS22X-STCL18	22	120	20	21	12.25	10	TCT18R...	1.2
JS25H-STCL18	25	100	20	24	12.25	10	TCT18R...	1.2
JS254X-STCL18	25.4	120	20	24	12.25	10	TCT18R...	1.2

Torque* : Recommended clamping torque (N·m)

Note: Use the right-hand insert (TCT18R...) for a left-hand holder (STCL...).

SPARE PARTS

Designation	Clamping screw	Wrench
STCL**18-CHP	CSTC-4L100DR	T-1008/5
STCR**18-CHP, JS**STCL18	CSTC-4L100DL	T-1008/5

Reference pages: Inserts → **E012**

C-STCFL-18-CHP

External grooving and threading toolholder, with high pressure coolant capability

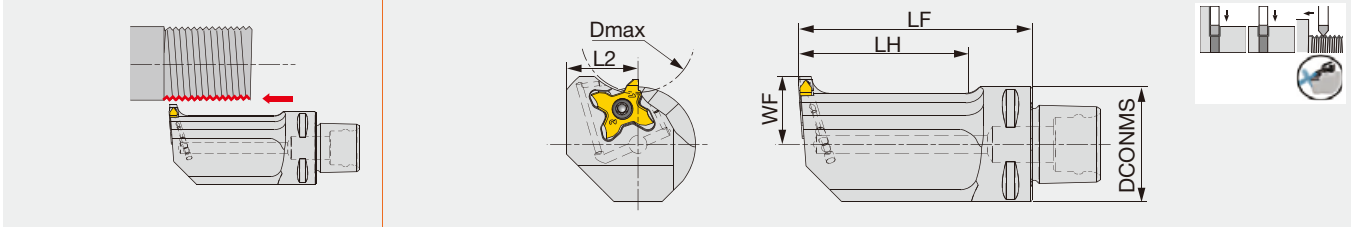

Designation	DCONMS	LF	LH	L2	WF	Dmax	Insert	Torque*
C3STCFL18040-18-CHP	32	40	21.5	20	18	32	TC*18R...	1.2
C3STCFL18065-18-CHP	32	65	46.5	20	18	32	TC*18R...	1.2

Torque* : Recommended clamping torque (N·m)
Applicable for 14 MPa coolant

Note: Use the right-hand insert (TC*18R...) for a left-hand holder (STCFL...).

C-STCR/L-18-CHP

External grooving and threading toolholder, with high pressure coolant capability

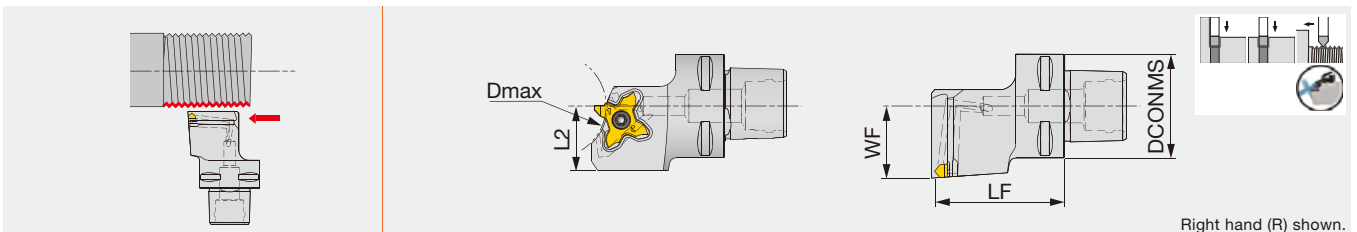

Designation	DCONMS	LF	L2	WF	Dmax	Insert	Torque*
C3STCR/L22040-18-CHP	32	40	20	22	32	TC*18...	1.2
C4STCR/L27050-18-CHP	40	50	25	27	75 ⁽¹⁾	TC*18...	1.2

Torque* : Recommended clamping torque (N·m)
Applicable for 14 MPa coolant

(1) The value for 3.5 mm groove depth. Dmax varies according to the grooving depth required. For further information, see Tungaloy Report #416 TetraMini-Cut/TetraForce-Cut.
Note: Use the right-hand insert (TC*18R...) for a right-hand holder (STCR...); the left-hand insert (TC*18L...) for a left-hand holder (STCL...).

SPARE PARTS

Designation	Clamping screw	Wrench
C*STCL**-18-CHP	CSTC-4L100DR	T-1008/5
C3STCFL**-18-CHP, C*STCR**-18-CHP	CSTC-4L100DL	T-1008/5

Reference pages: Inserts → **E012**

External grooving and threading head

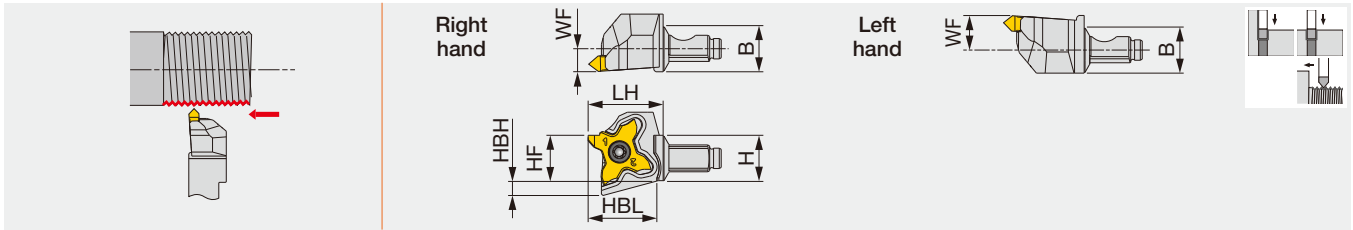

Designation	H	B	LH	HF	HBH	HBL	WF	Insert	Torque*
QC12-STCR18	12	12	19.5	12	3.9	17.9	6	TC*18R...	1.2
QC12-STCL18	12	12	21	12	3.9	18.3	9	TC*18L...	1.2

Torque* : Recommended clamping torque (N·m)

Note: Use the right-hand insert (TC*18R...) for a right-hand holder (QC12-STCR...); the left-hand insert (TC*18L...) for a left-hand holder (QC12-STCL...).

QC12-STCR/L-CHP

External grooving and threading head, with high pressure coolant capability

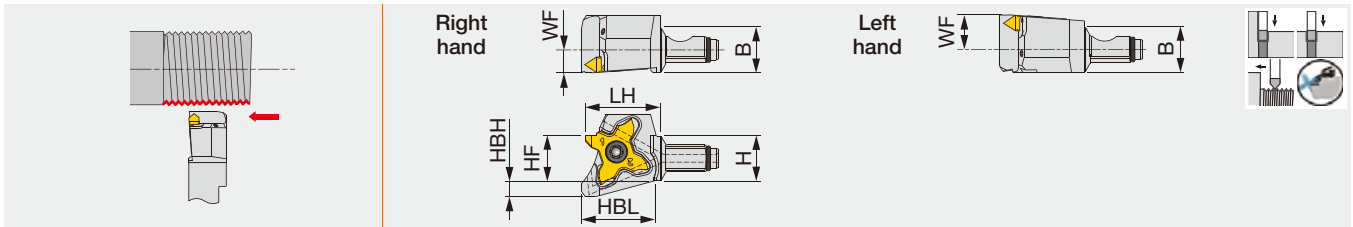

Designation	H	B	LH	HF	HBH	HBL	WF	Insert	Torque*
QC12-STCR18-CHP	12	12	19.5	12	4.2	19.3	6	TC*18R...	1.2
QC12-STCL18-CHP	12	12	21	12	4.2	19.3	9	TC*18L...	1.2

Torque* : Recommended clamping torque (N·m)

Through-coolant head

Note: Use the right-hand insert (TC*18R...) for a right-hand holder (QC12-STCR...); the left-hand insert (TC*18L...) for a left-hand holder (QC12-STCL...).

SPARE PARTS

Designation	Clamping screw	Wrench	O-ring
QC12-STCR18	CSTC-4L100DL	T-1008/5	-
QC12-STCL18	CSTC-4L100DR	T-1008/5	-
QC12-STCR18-CHP	CSTC-4L100DL	T-1008/5	ORSS-0454.5X1.0NBR70
QC12-STCL18-CHP	CSTC-4L100DR	T-1008/5	ORSS-0454.5X1.0NBR70

QC12-STCR/L-Y

Y-axis turning modular head for external grooving and threading

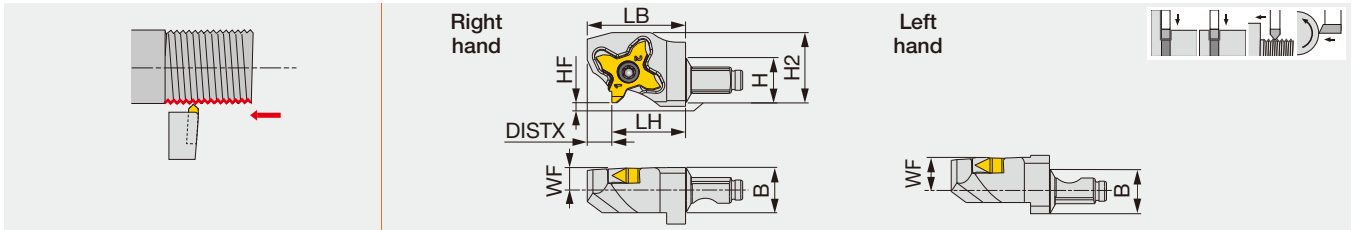

Designation	H	B	LH	HF	WF**	LB	H2	DISTX	Insert	Torque*
QC12-STCR/L18-Y	12	12	19.5	0	6/9	26	18.6	6.5	TC*18...	1.2

Torque* : Recommended clamping torque (N·m)

WF** : The first value before "/" indicates the WF for the right-hand holder and the second value after "/" for the left-hand holder.

Note: Use the right-hand insert (TC*18R...) for a right-hand holder (QC12-STCR...); the left-hand insert (TC*18L...) for a left-hand holder (QC12-STCL...).

QC12-STCR/L-Y-CHP

Y-axis turning modular head for external grooving and threading, with high pressure coolant capability

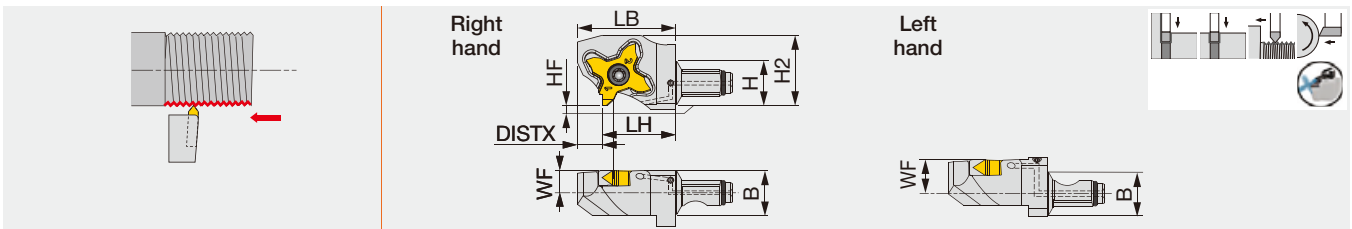

Designation	H	B	LH	HF	WF**	LB	H2	DISTX	Insert	Torque*
QC12-STCR/L18-Y-CHP	12	12	19.5	0	6/9	26	18.6	6.5	TC*18...	1.2

Torque* : Recommended clamping torque (N·m)

WF** : The first value before "/" indicates the WF for the right-hand holder and the second value after "/" for the left-hand holder.

Through-coolant head

Note: Use the right-hand insert (TC*18R...) for a right-hand holder (QC12-STCR...); the left-hand insert (TC*18L...) for a left-hand holder (QC12-STCL...).

SPARE PARTS

Designation	Clamping screw	Wrench	O-ring
QC12-STCR18-Y	CSTC-4L100DL	T-1008/5	-
QC12-STCL18-Y	CSTC-4L100DR	T-1008/5	-
QC12-STCR18-Y-CHP	CSTC-4L100DL	T-1008/5	ORSS-0454.5X1.0NBR70
QC12-STCL18-Y-CHP	CSTC-4L100DR	T-1008/5	ORSS-0454.5X1.0NBR70

Reference pages: Inserts → **E012**

Shank for modular heads

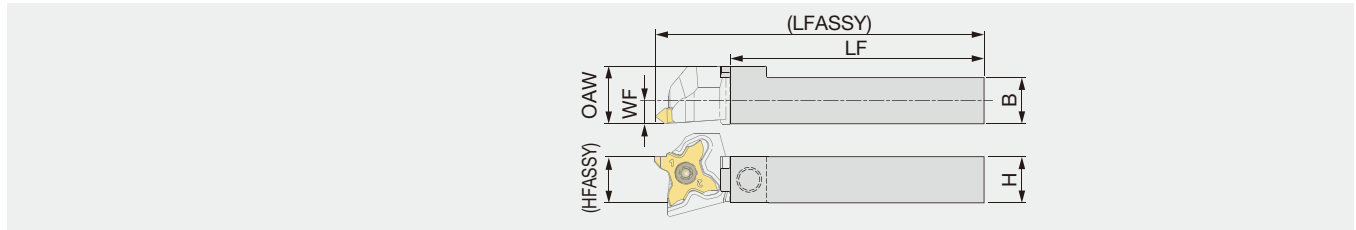

Designation	H	B	WF	LF	OAW	HFASSY	LFASSY ⁽¹⁾	Torque*
QC-1212F	12	12	6	65	15	12	85	3
QC-1212X	12	12	6	100	15	12	120	3

Torque* : Recommended clamping torque (N·m)
 (1) The size is true when the modular head with LH = 19.5 mm is mounted.

QC-1212-CHP

Shank for modular heads, with high pressure coolant capability

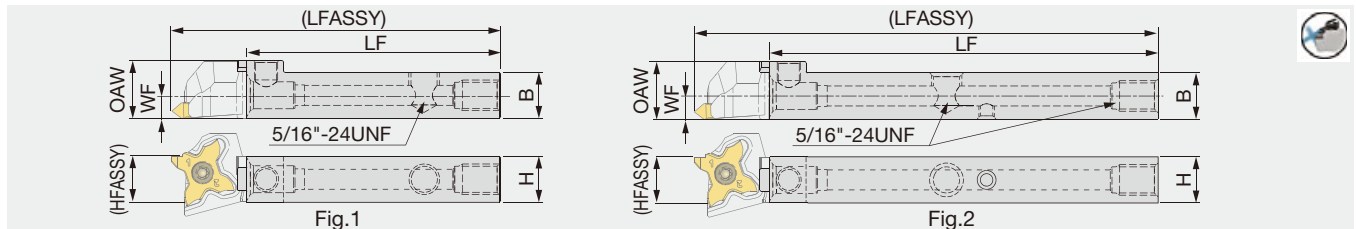

Designation	H	B	LF	WF	OAW	HFASSY	LFASSY ⁽¹⁾	Torque*	Fig.
QC-1212F-CHP	12	12	65	6	15	12	85	3	1
QC-1212X-CHP ^(*)	12	12	100	6	15	12	120	3	2

Torque* : Recommended clamping torque (N·m)
 Through-coolant shank
 (*) : Compatible to the direct internal coolant supply system without the use of external coolant hose.
 (1) The size is true when the modular head with LH = 19.5 mm is mounted.

SPARE PARTS						
Designation	Clamping screw	Wrench 1	Coolant plug	Wrench 2	DirectJet plug	Wrench 3
QC-1212*	SRM6X0.5-26977	P-3	-	-	-	-
QC-1212F-CHP	SRM6X0.5-26977	P-3	SR5/16UNFTL360	P-4	-	-
QC-1212X-CHP	SRM6X0.5-26977	P-3	SR5/16UNFTL360	P-4	SSHM4-6-TB	P-2

Unique coupling design

Simply loosen the clamping screw for easy tool exchanges.
 Unique coupling design allows extremely high repeatability.



Threading and parting toolholder, for Swiss lathes

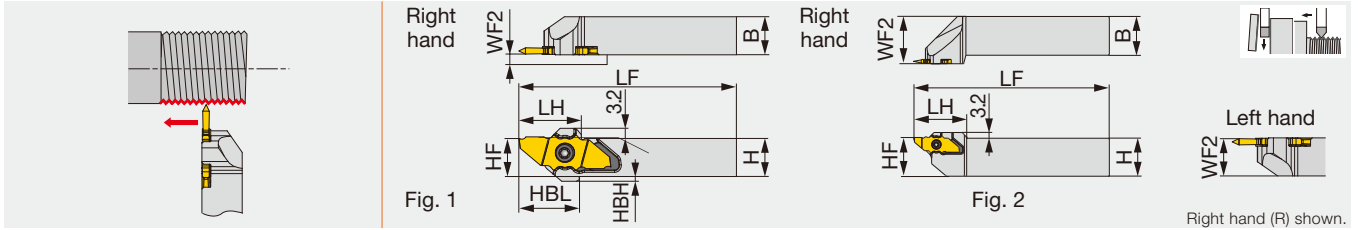

Designation	H	B	LF	LH	HF	WF2 ⁽¹⁾	HBL	HBH	Insert	Torque*	Fig.
JSXXR/L1010X09	10	10	118	17.65	10	0.2/9.8	17	3	JX**12...	1.2	1
JSXXR/L1212F09	12	12	83	17.65	12	0.2/11.8	17	1.5	JX**12...	1.2	1
JSXXR/L1212X09	12	12	118	17.65	12	0.2/11.8	17	1.5	JX**12...	1.2	1
JSXXR/L1616X09	16	16	118	17.65	16	0.2/15.8	-	-	JX**12...	1.2	1
JSXXR/L2020H09	20	20	98	20.5	20	0.2/19.8	-	-	JX**12...	1.2	1
JSXXR/L2525Z09	25	25	133	32	25	30	-	-	JX**12...	1.2	2

Torque* : Recommended clamping torque (N·m)

(1) The first value before "/" indicates the WF2 for the right-hand holder and the second value after "/" for the left-hand holder.

Note: Use the right-hand insert (JX****R...) for a right-hand holder (JSXXR...); the left-hand insert (JX****L...) for a left-hand holder (JSXXL...).

JSXXR/L-F/H/X-CHP

Parting and threading toolholder, with high pressure coolant capability

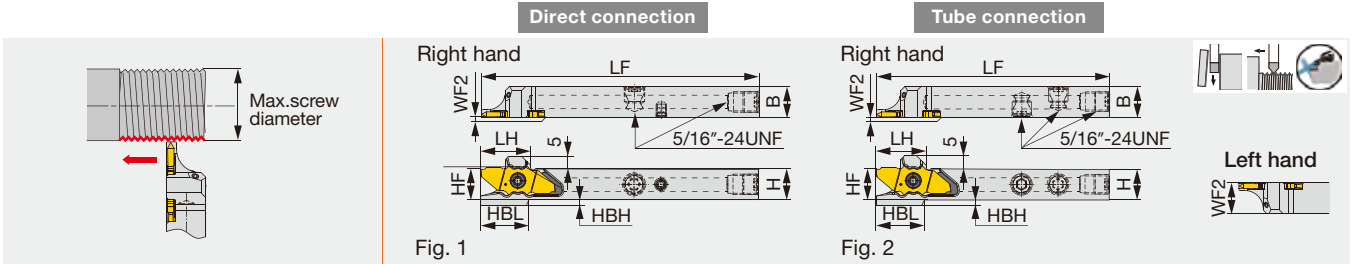

Designation	H	B	LF	LH	HF	WF2 ⁽¹⁾	HBL	HBH	Insert	Torque*	Fig.
JSXXR/L1012H09-CHP ⁽²⁾	10	12	100	17.2	10	0.2/11.8	16.7	3	JX**12...	1.2	1
JSXXR/L1212F09-CHP	12	12	83	17.4	12	0.2/11.8	16.8	2	JX**12...	1.2	2
JSXXR/L1212X09-CHP ⁽²⁾	12	12	118	17.4	12	0.2/11.8	16.8	2	JX**12...	1.2	1
JSXXR1616X09-CHP ^{(2),(3)}	16	16	118	17.4	16	0.2	16.7	2.5	JX**12...	1.2	1
JSXXR/L1616X09B-CHP ⁽²⁾	16	16	118	17.4	16	0.2/15.8	16.7	-	JX**12...	1.2	1

Torque* : Recommended clamping torque (N·m)

(1) The first value before "/" indicates the WF2 for the right-hand holder and the second value after "/" for the left-hand holder.

(2) Compatible to the direct internal coolant supply system without the use of external coolant hose.

(3) To be replaced with the new design

Note: Use the right-hand insert (JX****R...) for a right-hand holder (JSXXR...); the left-hand insert (JX****L...) for a left-hand holder (JSXXL...).

SPARE PARTS

Designation	Clamping screw	Wrench 1	Coolant plug	Wrench 2	DirectJet plug	Wrench 3
JSXXR...	CSTC-4L100DL	T-1008/5	-	-	-	-
JSXXL...	CSTC-4L100DR	T-1008/5	-	-	-	-
JSXXR**F...	CSTC-4L100DL	T-1008/5	SR5/16UNFTL360	P-4	-	-
JSXXL**F...	CSTC-4L100DR	T-1008/5	SR5/16UNFTL360	P-4	-	-
JSXXR**H/X...	CSTC-4L100DL	T-1008/5	SR5/16UNFTL360	P-4	SSHM4-6-TB	P-2
JSXXL**H/X...	CSTC-4L100DR	T-1008/5	SR5/16UNFTL360	P-4	SSHM4-6-TB	P-2



External threading toolholder, for 2 corner inserts

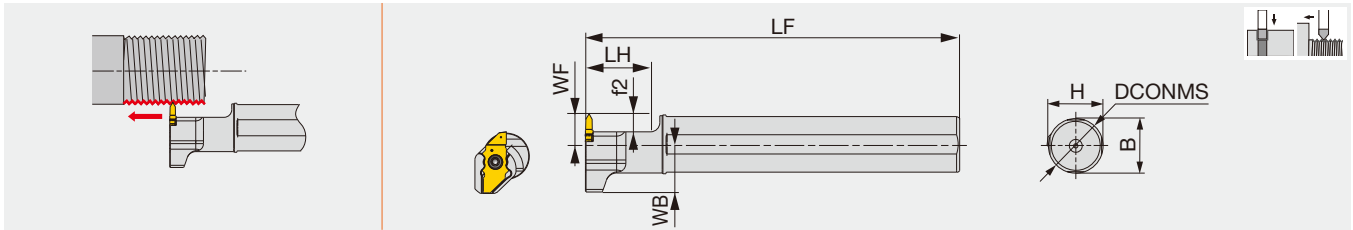

Designation	DCONMS	H	B	LF	LH	WB	WF	f2	Insert	Torque*
JS19G-SXXL09	19.05	18	18	90	21	15.43	8	4	JX**12...	1.2
JS19X-SXXL09	19.05	18	18	120	21	15.43	8	4	JX**12...	1.2
JS20G-SXXL09	20	19	19	90	21	15.4	8	4	JX**12...	1.2
JS20X-SXXL09	20	19	19	120	21	15.4	8	4	JX**12...	1.2
JS22X-SXXL09	22	21	21	120	21	15.4	8	4	JX**12...	1.2
JS25H-SXXL09	25	24	24	100	21	15.4	8	4	JX**12...	1.2
JS254X-SXXL09	25.4	24	24	120	21	15.4	8	4	JX**12...	1.2

Torque* : Recommended clamping torque (N-m)

J-SERIES
JSTTR/L

External toolholder for Swiss lathes

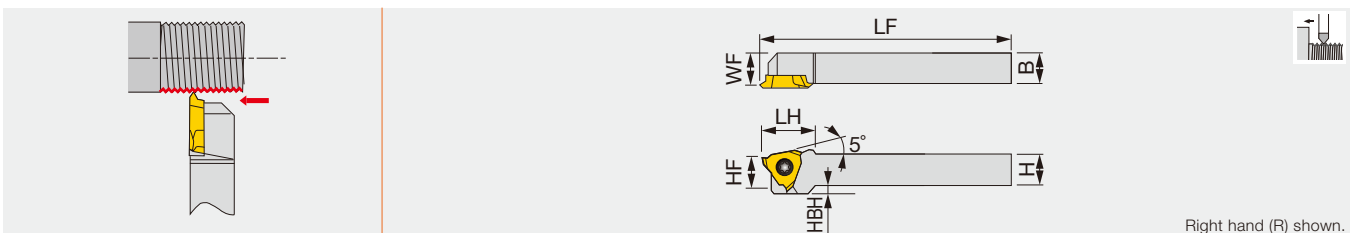

Right hand (R) shown.

Designation	H	B	LF	LH	HF	WF	HBH	Insert
JSTTR/L1010X3	10	10	120	18.5	10	9.5	2	JTTR/L30...
JSTTR/L1212F3	12	12	85	18.5	12	11.5	-	JTTR/L30...
JSTTR/L1212X3	12	12	120	18.5	12	11.5	-	JTTR/L30...
JSTTR/L1616X3	16	16	120	16.5	16	15.5	-	JTTR/L30...

Recommended clamping torque: 1.2 N-m

SPARE PARTS

Designation	Clamping screw 1	Clamping screw 2	Wrench 1	Wrench 2	Wrench 2 (Optional)
JSTTR/L...	-	CSTB-4SD	-	T-8F	(T-8L)
JS***-SXXL09	CSTC-4L055L	-	T-1008/5	-	-

Reference pages: DuoJust-Cut : Inserts → **E012**
 J-Series : Inserts → **E013**

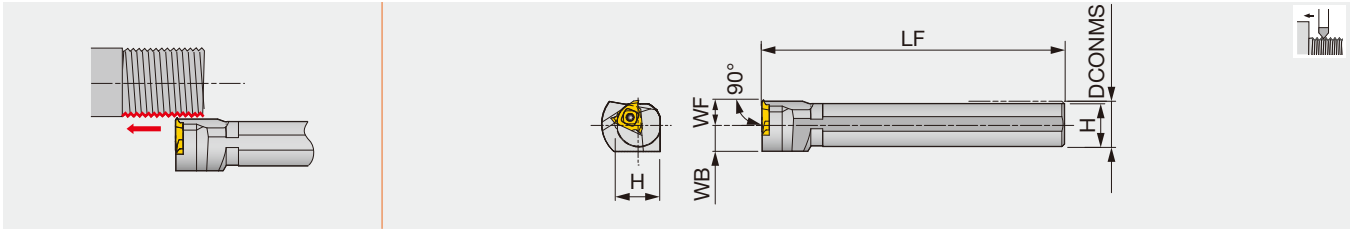

Designation	DCONMS	WF	LF	H	WB	Insert
JS19K-TTL3	19.05	10	125	18	11.5	JTTR30...
JS20K-TTL3	20	10	125	19	11.5	JTTR30...
JS22K-TTL3	22	10	125	21	11.5	JTTR30...
JS25K-TTL3	25.4	10	125	24	12.7	JTTR30...

Recommended clamping torque: 3.5 N·m

JSXBR

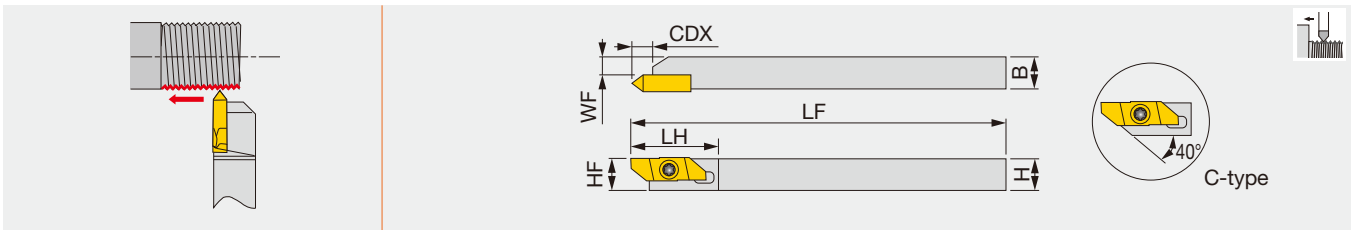

Designation	H	B	LF	LH	CDX	HF	WF	Insert
JSXBR1010K8-C	10	10	125	29	6.4	10	5.7	JXT*R...
JSXBR1212K8-C	12	12	125	29	6.4	12	7.7	JXT*R...
JSXBR1616K8	16	16	125	29	6.4	16	11.7	JXT*R...
JSXBR2020K8	20	20	125	29	6.4	20	15.7	JXT*R...
JSXBR2525K8	25	25	125	29	6.4	25	20.7	JXT*R...

Note: Can be wrenched also from the back with a double-head screw.
This toolholder can be used for JXB back-turning insert and JXT threading insert.

SPARE PARTS

Designation	Clamping screw	Wrench 1	Wrench 2 (Optional)
JS**-TTL3	CSTB-4S	T-15F	-
JSXBR...	CSTB-4SD	T-8F	(T-8L)



TUNGST-CLAMP

FLASR/L

External grooving and threading toolholder, for Swiss lathes

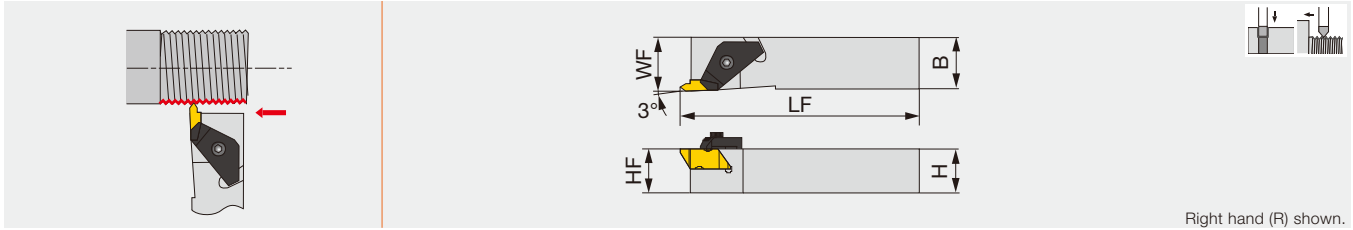

Designation	H	B	LF	HF	WF	Insert	Torque*
FLASR/L-1616M3	16	16	125	16	16	FLT-3...	3

Torque* : Recommended clamping torque (N·m)

Note: Use the right-hand insert (FLT-3R...) for a right-hand holder (FLASR...); the left-hand insert (FLT-3L...) for a left-hand holder (FLASL...).

FLSR/L

External grooving and threading toolholder

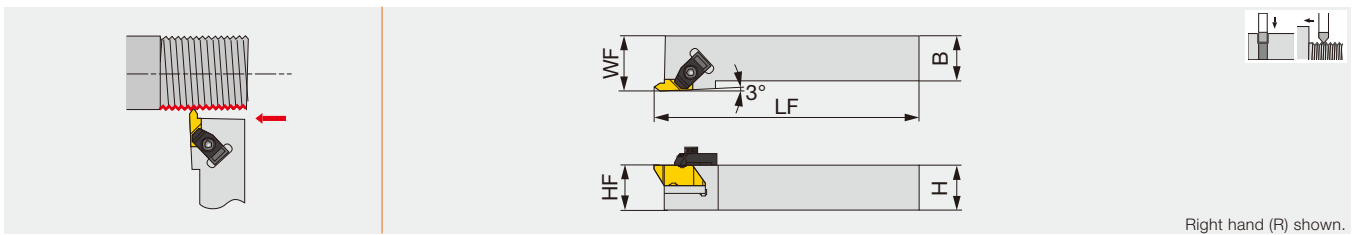

Designation	H	B	LF	HF	WF	Insert	Torque*
FLSR/L-2020M3	20	20	125	20	32	FLT-3...	3
FLSR/L-2525M3	25	25	150	25	32	FLT-3...	3

Torque* : Recommended clamping torque (N·m)

Note: Use the right-hand insert (FLT-3R...) for a right-hand holder (FLSR...); the left-hand insert (FLT-3L...) for a left-hand holder (FLSL...).

SPARE PARTS



Designation	Clamp	Clamping screw	Wrench
FLASR-1616M3	TF-184	S-412	5/32HEX
FLASL-1616M3	TF-185	S-412	5/32HEX
FLSR-****M3	TF-72	S-412	5/32HEX
FLSL-****M3	TF-73	S-412	5/32HEX

Reference pages: Inserts → [E014](#)

External threading toolholder, for single-sided lay down inserts

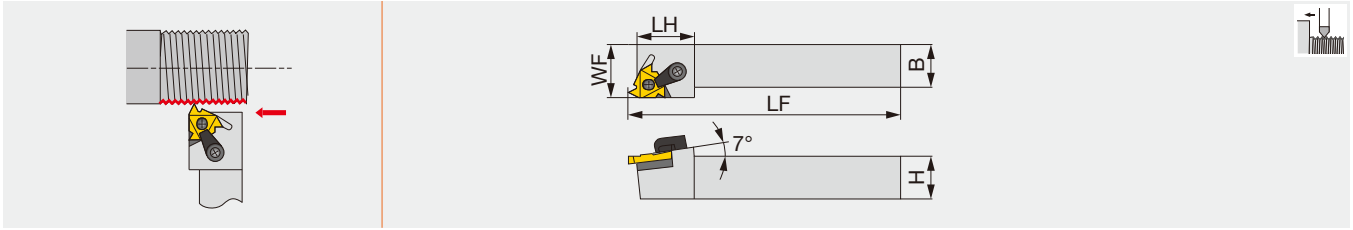

Designation	H	B	LF	LH	WF	Insert
MTVNR-2525M5	25	25	152	39	31.8	L535B**EXT-FC
MTVNR-3232M5	32	32	178	39	38.1	L535B**EXT-FC

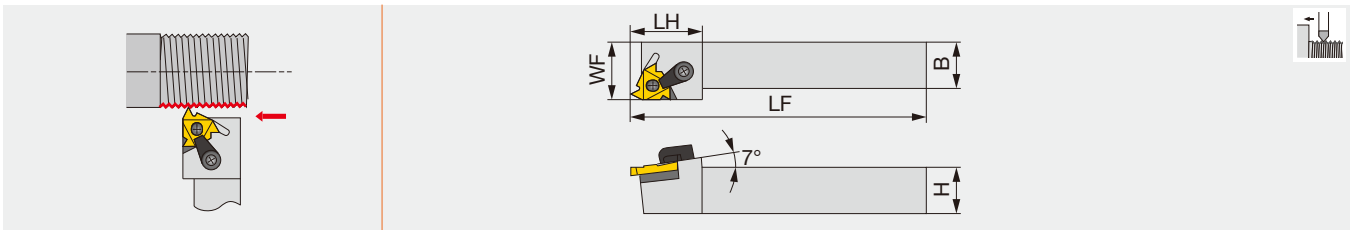

MTVNR-54

External threading toolholder, for double-sided lay down inserts



Designation	H	B	LF	LH	WF	Insert
MTVNR-3232M54	32	32	178	39	38.1	LDS54**FT-CB#...

SPARE PARTS

Designation					
Designation	Shim	Lock pin	Clamp	Clamping screw	Wrench
MTVNR.... MTVNR-3232M54	LS53NOFORMEXT	NL-58	TC-250	STC-11	1/8HEX



Multi-clamp external threading toolholder, for on edge inserts

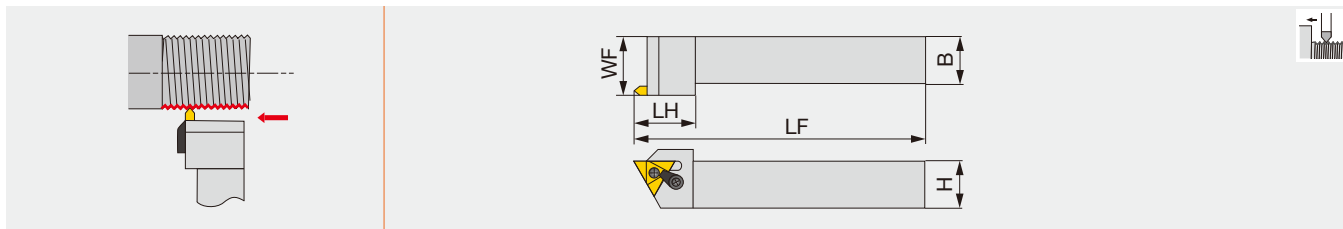

Designation	H	B	LF	LH	WF	Insert
MTVOR-2525M4	25	25	150	31	31.7	TNM*43...
MTVOR-3232M4	32	32	170	32	38.1	TNM*43...
MTVOR-2525M5	25	25	150	36	31.7	TNM*54...
MTVOR-3232M5	32	32	178	36	38.1	TNM*54...

Note: STVOR is recommended for TNMC insert although the insert can be used on multi-clamp (M type) toolholder.

STVOR

Screw-on external threading toolholder, for on edge inserts

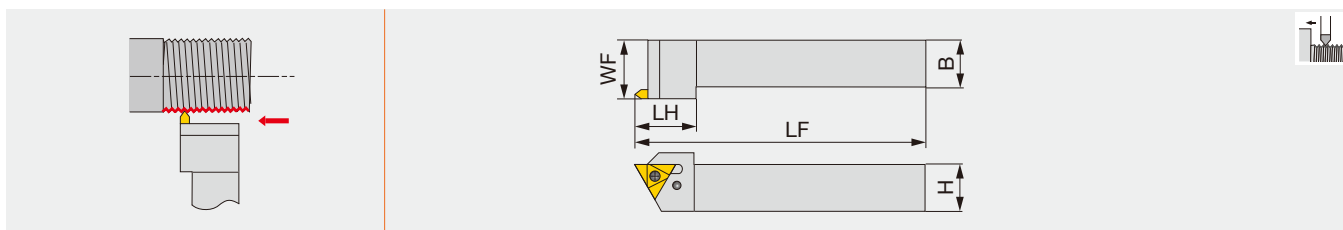

Designation	H	B	LF	LH	WF	Insert
STVOR-2525M4	25	25	150	31	31.7	TNMC43...
STVOR-3232M4	32	32	178	31	38.1	TNMC43...
STVOR-2525M5	25	25	150	36	31.7	TNMC54...
STVOR-3232M5	32	32	178	36	38.1	TNMC54...

SPARE PARTS



Designation	Clamping screw	Lock pin	Wrench 1	Wrench 2	Clamp (Optional)	Clamping screw (Optional)
MTVOR-**M4	-	NL-44	-	3/32HEX	TC-190	STC-5
MTVOR-**M5	-	NL-56	-	1/8HEX	TC-250	STC-11
STVOR-**M4	SD2	-	T-20TORX	3/32HEX	TC-190	STC-9
STVOR-**M5	SD3	-	T-20TORX	1/8HEX	TC-250	STC-11

TT-R/LE

TT-type pin-lock external threading toolholder

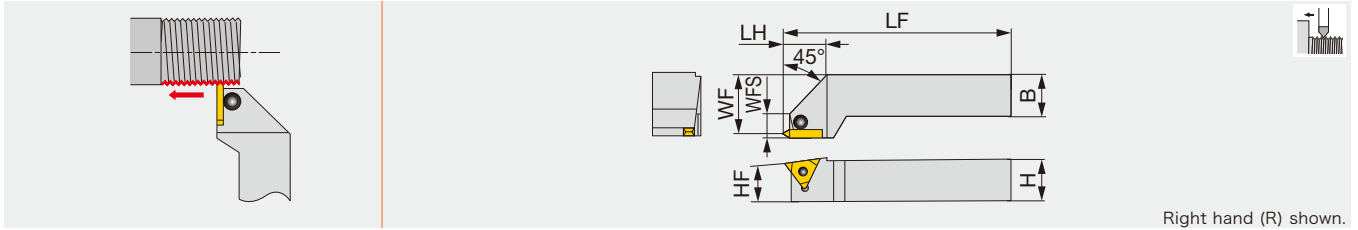

Right hand (R) shown.

Designation	H	B	LF	LH	HF	WF	WFS	Insert
TT-2525R/LE	25	25	150	25	25	32	15	TTR/L42...





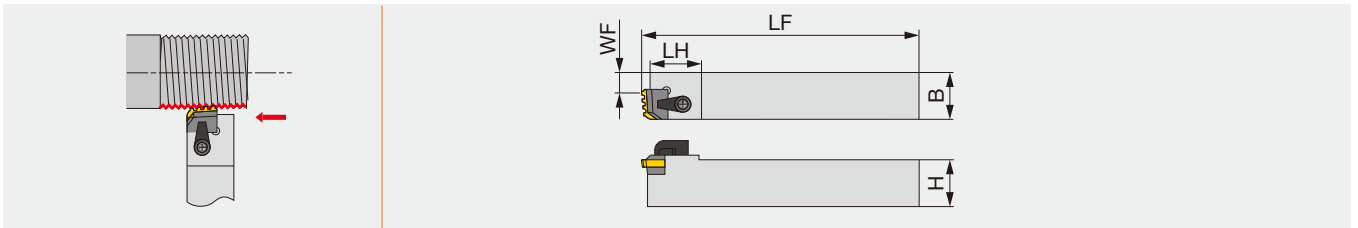

CLVOR

External threading toolholder, for chaser inserts



Designation	WF	LF	LH	H	B	Insert
CLVOR-25M6	16.1	177	32	25	25	CR...
CLVOR-32M6	16.1	177	32	32	32	CR...
CLVOR-40M8	21	170	38.1	40	40	CR-5B75-4E

SPARE PARTS

Designation							
Designation	Shim	Shim screw	Clamp 1	Clamp 2	Clamping screw	Wrench 1	Wrench 2
TT-2525R/LE	-	-	CP91	-	DS-6	-	P-3
CLVOR-25M6	TF1207	SF80	-	TC-311	STC-4	T-25TORX	5/32HEX
CLVOR-32M6	TF1207	SF85	-	TC-311	STC-4	T-25TORX	5/32HEX
CLVOR-40M8	TF8132-E	SF60	-	TC-311	STC-4	T-20TORX	5/32HEX

Reference pages: TT-R/LE : Inserts → **E014, E016**
 CLVOR : Inserts → **E026, E031 - E034**

Internal threading bars, Screw-on clamp

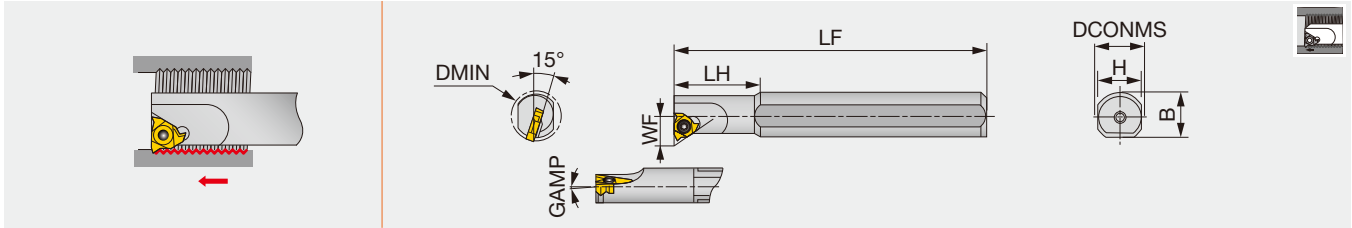

Designation	Material	DMIN	DCONMS	WF	LF	LH	H	B	GAMP	Coolant hole	Insert
SIR0005H06	STEEL	6.4	12	4.3	100	12	11	-	1.5°	Without	06IR...
SIR0007K08	STEEL	8	16	5.3	125	18	15	-	1.5°	Without	08IR...
SIR0005H06CB	CARBIDE	6.4	6	4.3	100	25	5	-	1.5°	With	06IR...
SIR0007K08CB	CARBIDE	7.8	8	5.3	125	30	7	-	1.5°	With	08IR...

Note: Use the right-hand insert (**IR...) for a right-hand holder (SIR...).
Recommend over 1 mm clearance between internal diameter of thread and each tools DMIN.

Applicable thread size

Description	ISO metric	Unified IRA60 Insert	Parallel pipe IRA55 Insert
SIR0005H06...	≥ M9	≥ 3/8-24 UNF	≥ G1/8
SIR0007K08...	≥ M11	≥ 7/16-20 UNF	≥ G1/4

SNR-2/3

Screw-on internal threading toolholder

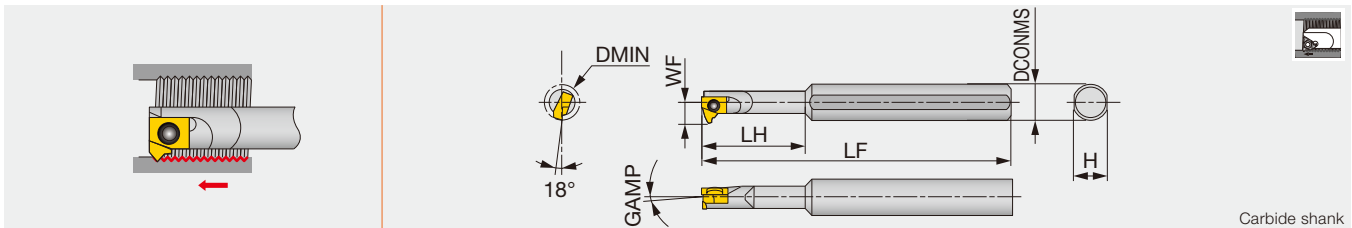

Carbide shank

Designation	Material	DMIN	DCONMS	WF	LF	LH	H	GAMP	Insert
SNR0006H06-2	Steel	8	8	4.7	100	18	7	2°	6IR...
SNR0006H06-3	Steel	8	8	4.7	100	18	7	3°	6IR...
SNR0008H06-2	Steel	10	8	5.7	100	18	7	2°	6IR...
SNR0008H06-3	Steel	10	8	5.7	100	18	7	3°	6IR...
SNR0006K06SC-2	Carbide	8	8	4.7	125	30	7	2°	6IR...
SNR0006K06SC-3	Carbide	8	8	4.7	125	30	7	3°	6IR...
SNR0008K06SC-2	Carbide	10	8	5.7	125	18	7	2°	6IR...
SNR0008K06SC-3	Carbide	10	8	5.7	125	18	7	3°	6IR...

Note: Use the right-hand insert (6IR...) for a right-hand holder (SNR...).

SPARE PARTS



Designation	Clamping screw	Wrench
SIR0005H06...	SR 14-552	T-6F-S
SIR0007K08...	SR 14-558	T-6F-S
SNR0006H06...	CSTB-2L040	T-6F
SNR0008H06...	CSTB-2L	T-6F
SNR0006K06SC...	CSTB-2L040	T-6F
SNR0008K06SC...	CSTB-2L	T-6F

Reference pages: SIR : Inserts → **E010, E015, E017**
SNR-2/3 : Inserts → **E010, E015, E017, E023 - E025**

SNR/L

Screw-on internal threading toolholder

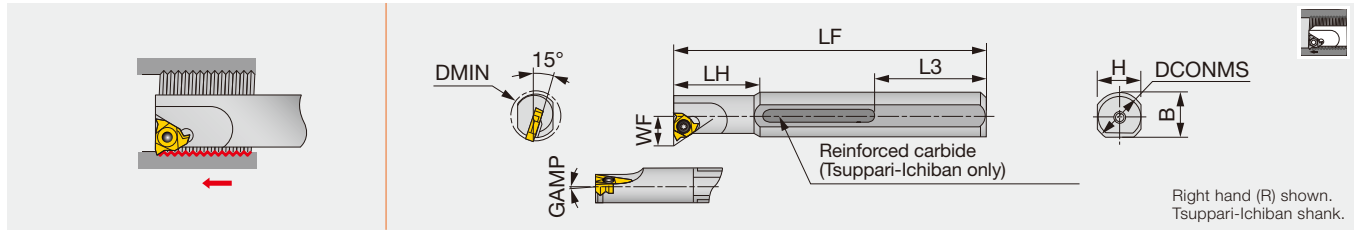

Designation	Material	DMIN	DCONMS	WF	LF	LH	L3	H	B	GAMP	Insert
TSNR0016Q16	Reinforced	19	16	10.6	180	40	59	15	-	1°	16IR...
TSNR0020R22	Reinforced	24	20	13.9	200	50	49	18	-	1°	22IR...
SNR/L0010K11	Steel	12	16	6.6	125	25	-	15	15.5	1°	11IR/L...
SNR0010K11-2	Steel	12	16	6.6	125	25	-	15	15.5	2°	11IR...
SNR0010K11-3	Steel	12	16	6.6	125	25	-	15	15.5	3°	11IR...
SNR/L0013L11	Steel	15	16	8.2	140	32.5	-	15	15.5	1°	11IR/L...
SNR0013L11-2	Steel	15	16	8.2	140	32.5	-	15	15.5	2°	11IR...
SNR0013L11-3	Steel	15	16	8.2	140	32.5	-	15	15.5	3°	11IR...
SNR/L0016M16	Steel	19	16	10.6	150	40	-	15	15.5	1°	16IR/L...
SNR0016M16-2	Steel	19	16	10.6	150	40	-	15	15.5	2°	16IR...
SNR0016M16-3	Steel	19	16	10.6	150	40	-	15	15.5	3°	16IR...
SNR/L0020Q22	Steel	24	20	13.9	180	50	-	18	19	1°	22IR/L...
SNR0020Q22-2	Steel	24	20	13.9	180	50	-	18	19	2°	22IR...
SNR0020Q22-3	Steel	24	20	13.9	180	50	-	18	19	3°	22IR...
SNR0010M11SC	Carbide	13	10	7.4	150	24	-	9	-	1°	11IR...
SNR0010M11SC-2	Carbide	13	10	7.4	150	24	-	9	-	2°	11IR...
SNR0010M11SC-3	Carbide	13	10	7.4	150	24	-	9	-	3°	11IR...
SNR0012P11SC	Carbide	15	12	8.5	170	28	-	11	-	1°	11IR...
SNR0012P11SC-2	Carbide	15	12	8.5	170	28	-	11	-	2°	11IR...
SNR0012P11SC-3	Carbide	15	12	8.5	170	28	-	11	-	3°	11IR...
SNR/L0016R16SC	Carbide	20	16	11.9	200	35	-	15	-	1°	16IR/L...
SNR0016R16SC-2	Carbide	20	16	11.9	200	35	-	15	-	2°	16IR...

Note: Use the right-hand insert (**IR...) for a right-hand holder (SNR...); the left-hand insert (**L...) for a left-hand holder (SNL...).

SPARE PARTS

Designation	Clamping screw	Wrench
TSNR0016Q16	CSTB-3.5	T-15F
TSNR0020R22	CSTB-4	T-15F
SNR/L00**11...	CSTB-2.5	T-8F
SNR/L0016M16...	CSTB-3.5	T-15F
SNR/L0020Q22...	CSTB-4	T-15F
SNR00**11SC...	CSTB-2.5	T-8F
SNR/L0016R16SC...	CSTB-3.5	T-15F

Reference pages: Inserts → [E010](#) - [E011](#), [E015](#), [E017](#) - [E030](#), [E032](#)



Clamp-on internal threading toolholder (alternative clamping of screw-on or clamp-on only for DT type)

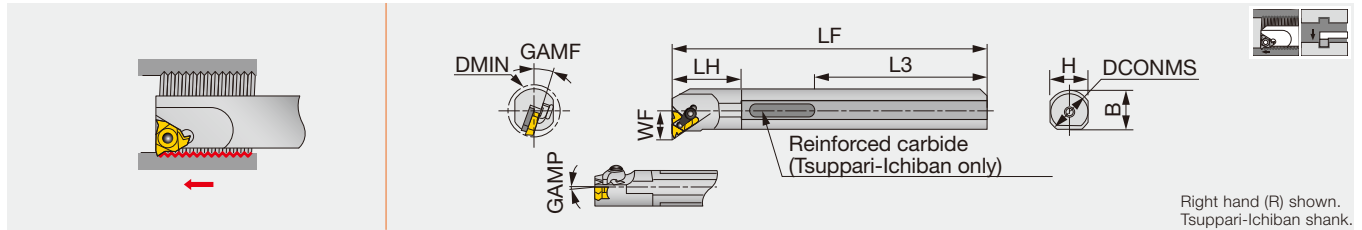

Right hand (R) shown.
Tsuppari-Ichiban shank.

Designation	Material	DMIN	DCONMS	WF	LF	LH	L3	H	B	GAMF	GAMP	Insert
TCNR0020R16DT	Reinforced	24	20	14	200	30	49	18	-	15°	1°	16IR...
TCNR0025S16DT	Reinforced	29	25	16.5	250	38	64	23	-	15°	1°	16IR...
TCNR0025S22DT	Reinforced	30	25	18.2	250	38	64	23	-	15°	1°	22IR...
CNR/L0020P16	Steel	24	20	14	170	30	-	18	19	15°	1°	16IR/L...
CNR/L0025R16	Steel	29	25	16.5	200	38	-	23	24	15°	1°	16IR/L...
CNR/L0032S16	Steel	37	32	20.1	250	48	-	30	31	15°	1°	16IR/L...
CNR/L0025R22	Steel	30	25	18.2	200	38	-	23	24	15°	1°	22IR/L...
CNR/L0032S22	Steel	38	32	21.9	250	48	-	30	31	15°	1°	22IR/L...
CNR0040T27	Steel	46	40	26.9	300	60	-	37	38.5	10°	1°	27IR...

Note: A clamp set consists of a clamp and a clamping screw.

A shim set consists of a shim and a shim screw to secure the shim to the shank.

Standard shims can be used on both right- and left-hand toolholders. Please use either of the sides depending on the tool hand.

Use the right-hand insert (**IR...) for a right-hand holder (CNR...); the left-hand insert (**IL...) for a left-hand holder (CNL...).

When using DT type, please remove either the clamp set or the insert clamping screw.

BOREMEISTER

S-SNR-H

Screw-on clamp exchangeable boring head, for threading inserts

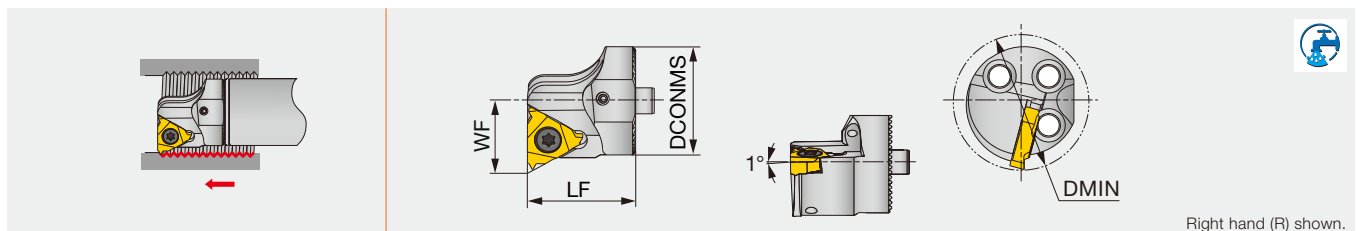

Right hand (R) shown.

Designation	DMIN	DCONMS	WF	LF	Shank	Insert
S20-SNR16-H	25	20	14	25	D20	16IR...
S25-SNR16-H	32	25	17	25	D25	16IR...
S32-SNR16-H	40	32	22	32	D32	16IR...
S40-SNR16-H	50	40	27	32	D40, D50, D60	16IR...

SPARE PARTS

Designation	Clamp set	Clamping screw	Shim screw	Shim	Shim set R	Shim set L	Wrench 1	Wrench 2	Wrench 3
TCNR002**16DT	CSP16	CSTB-3.5ST	DTS5-3.5	A16-1DT	-	-	P-3.5	T-15F	-
TCNR0025S22DT	CSP22	CSTB-4ST	DTS6-4	GX22-1DT	-	-	P-4	T-15F	T-20F
CNR/L**16	CSP16	-	-	-	A16-1	A16-1	-	T-15F	-
CNR/L**22	CSP22	-	-	-	NXN22-1	NXE22-1	-	T-20F	-
CNR0040T27	CSP27	-	-	-	NXN27-1	NXE27-1	P-4	-	-
S**-SNR16-H	-	CSTB-3.5	-	-	-	-	-	T-15F	-

Reference pages: CNR/L : Inserts → **E010 - E011, E015, E017 - E030, E032**
S-SNR-H : Inserts → **E010 - E011, E015, E018 - E030**

Anti-vibration bars with through coolant for interchangeable turning heads

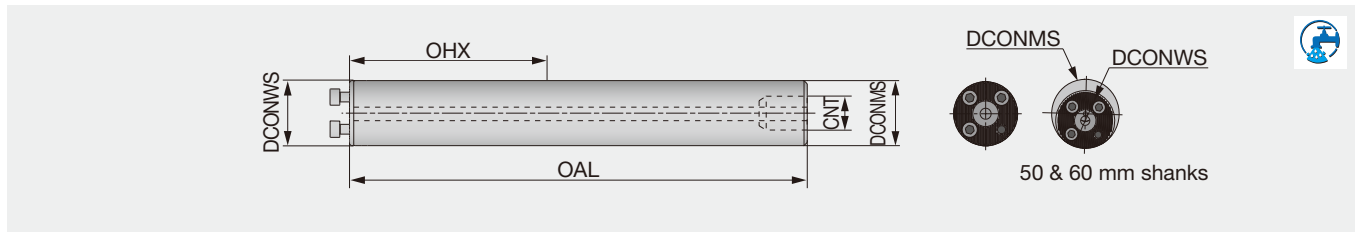

Designation	Material	DCONWS	DCONMS	OAL	OHX	CNT
D16-L156-7D-C	Steel	16	16	156.3	92	G1/8
G16-L204-10D-E	Carbide	16	16	204.3	140	-
D20-L200-7D-C	Steel	20	20	200.3	120	G1/4
G20-L260-10D-E	Carbide	20	20	260.3	180	-
D25-L255-7D-C	Steel	25	25	257.5	155	G1/4
D25-L330-10D-C	Steel	25	25	332.5	230	G1/4
D32-L320-7D-C	Steel	32	32	323	192	G3/8
D32-L416-10D-C	Steel	32	32	419	288	G3/8
D40-L408-7D-C	Steel	40	40	411	248	G1/2
D40-L528-10D-C	Steel	40	40	531	368	G1/2
D50-L518-7D-C	Steel	40	50	523	318	G1/2
D50-L668-10D-C	Steel	40	50	673	468	G1/2
D60-L628-7D-C	Steel	40	60	633	388	G3/4
D60-L808-10D-C	Steel	40	60	813	568	G3/4

D#4D-SH

Steel shank for internal turning, with through coolant

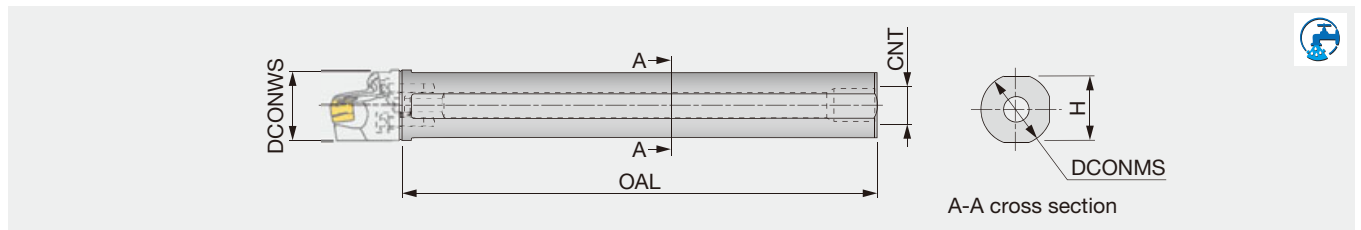

Designation	Material	DCONWS	DCONMS	OAL	CNT	H
D16-L105-4D-SH	Steel	16	16	105	UNC-2B 3/8"-16	15
D20-L140-4D-SH	Steel	20	20	140	UNFC-2B 3/8"-24	18
D25-L200-4D-SH	Steel	25	25	200	UNF-2B 1/2"-20	23
D32-L218-4D-SH	Steel	32	32	218	UNF-2B 1/2"-20	29
D40-L283-4D-SH	Steel	40	40	283	UNF-2B 1/2"-20	36

SPARE PARTS

Designation	Clamping screw	Wrench
D16-L..., G16-L..., D16**4D-SH	SRM3X10DIN912	HW2.5
D20-L..., G20-L..., D20**4D-SH	SR55-2M3.5X10	HW2.5
D25-L..., D25**4D-SH	SRM4X12DIN912	HW3.0
D32-L..., D32**4D-SH	SRM5X12DIN912	HW4.0
D40-L..., D50-L..., D60-L..., D40**4D-SH	SRM6X16DIN912-12.9	HW5.0

BOREMEISTER

RSL sleeve

Split sleeve for anti-vibration bar

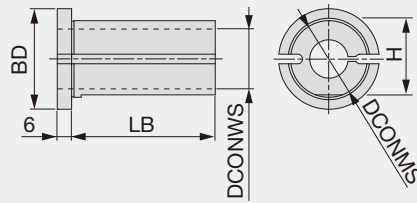

Designation	DCONWS	DCONMS	BD	LB	H
RSL-32-16-L66	16	32	42	60	31
RSL-32-20-L66	20	32	42	60	31
RSL-32-25-L66	25	32	42	60	31
RSL-40-16-L76	16	40	50	70	38.5
RSL-40-20-L76	20	40	50	70	38.5
RSL-40-25-L76	25	40	50	70	38.5

C#-SH-CHP / C#-SH-E-CHP

PSC compatible adapter with steel or carbide core

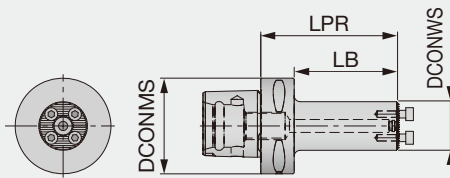

Fig. 1

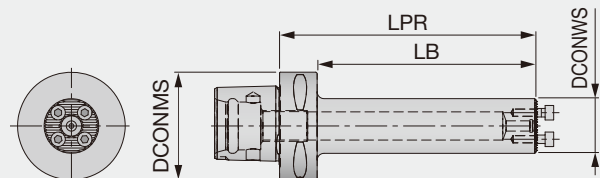

Fig. 2

Designation	Material	DCONWS	DCONMS	LPR	LB	Fig
C4-SH-D16-2.5D-CHP	Steel	16	40	40	20	1
C4-SH-D20-2.5D-CHP	Steel	20	40	50	30	1
C4-SH-D25-2.5D-CHP	Steel	25	40	55	35	1
C4-SH-D32-2.5D-CHP	Steel	32	40	75	55	1
C4-SH-D40-3D-CHP	Steel	40	40	80	80	1
C6-SH-D20-5D-E-CHP	Carbide	20	63	100	78	2
C6-SH-D25-5D-E-CHP	Carbide	25	63	115	93	2
C6-SH-D32-5D-E-CHP	Carbide	32	63	150	128	2
C6-SH-D40-5D-E-CHP	Carbide	40	63	185	163	2

SPARE PARTS



Designation	Clamping screw	Wrench
C4**D16...	SRM3X10DIN912	HW2.5
C4/C6**D20...	SRM55-2M3.5X10	HW2.5
C4/C6**D25...	SRM4X12DIN912	HW3.0
C4/C6**D32...	SRM5X12DIN912	HW4.0
C4/C6**D40...	SRM6X16DIN912-12.9	HW5.0

BOREMEISTER

C6-9D-C

PSC adapter with anti vibration, L/D = 9

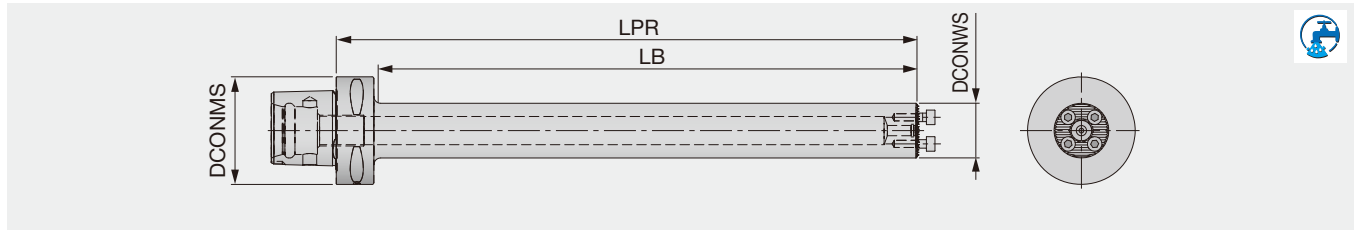

Designation	Material	DCONWS	DCONMS	LPR	LB	WT (kg)
C6-D25-L230-9D-C	Steel	25	63	230.5	200.1	1.65
C6-D32-L288-9D-C	Steel	32	63	288.5	259.5	2.73
C6-D40-L368-9D-C	Steel	40	63	368.5	339	4.45

AVC-SET

Center height set up device

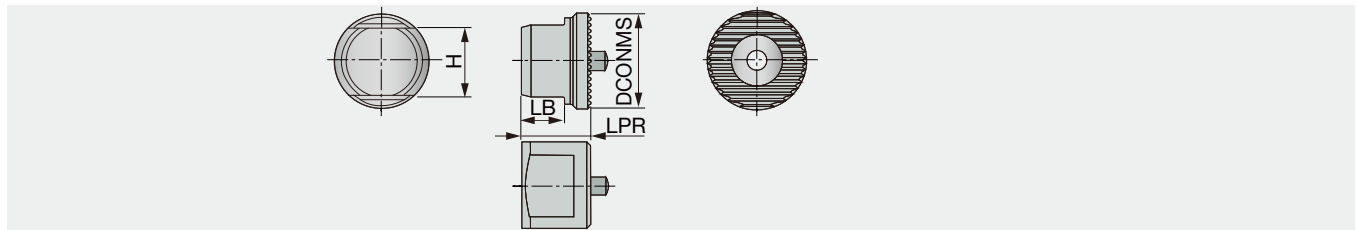

Designation	DCONMS	H	LPR	LB	Applicable shank
AVC-SET 16-25	20	15	14.5	8.9	16, 20, 25
AVC-SET 32-60	29	16	17.5	11.43	32, 40, 50, 60

SPARE PARTS



Designation	Clamping screw	Wrench
C6-D25...	SRM4X12DIN912	HW3.0
C6-D32...	SRM5X12DIN912	HW4.0
C6-D40...	SRM6X16DIN912-12.9	HW5.0

TINYM^{INI}TURN

TBIR

Solid boring bar for internal threading

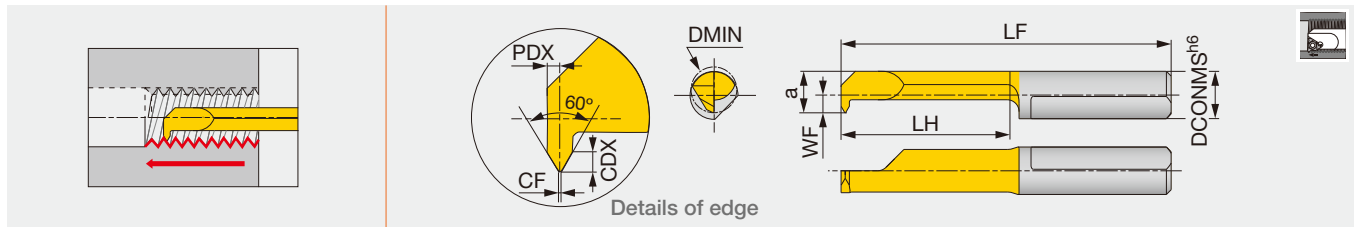

Designation	SH725	Pitch	DMIN	CF- ⁰ _{0.02}	DCONMS	WF	a	LF	LH	CDX	PDX
TBIR04140050-D040	●	0.5	4	0.06	4	1.5	3.5	30	14	0.3	0.35
TBIR07140050-D050	●	0.5	5	0.06	7	0.9	4.4	30	14	0.3	0.35
TBIR07140075-D050	●	0.75	5	0.09	7	0.9	4.4	30	14	0.4	0.45
TBIR07140100-D048	●	1	4.8	0.12	7	0.9	4.4	30	14	0.6	0.55
TBIR07140100-D060	●	1	6	0.12	7	1.8	5.3	30	14	0.6	0.55
TBIR07140150-D060	●	1.5	6	0.18	7	1.8	5.3	30	14	0.8	0.75

● : Line up

Grade
Insert
Ext. Toolholder
Int. Toolholder
Threading
Grooving
Miniature tool
Milling cutter
Endmill
Drilling tool
Tooling System
User's Guide
Index



Solid boring bars for threading (metric)

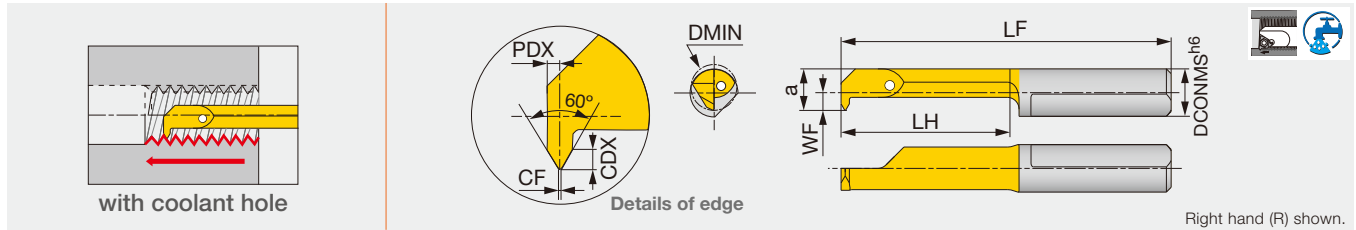

Right hand (R) shown.

Designation	SH730	Pitch	DMIN	CF -0.02	DCONMS	WF	a	LF	LH	CDX	PDX
JBIR04140050-D040	●	0.5	4	0.06	4	1.5	3.5	30	14	0.3	0.35
JBIR07140050-D050	●	0.5	5	0.06	7	0.9	4.4	30	14	0.3	0.35
JBIR07140075-D050	●	0.75	5	0.09	7	0.9	4.4	30	14	0.4	0.45
JBIR07140100-D048	●	1	4.8	0.12	7	0.9	4.4	30	14	0.6	0.55
JBIR07140100-D060	●	1	6	0.12	7	1.8	5.3	30	14	0.6	0.55
JBIR07140125-D060	●	1.25	6	0.15	7	1.8	5.3	30	14	0.7	0.65
JBIR07140150-D060	●	1.5	6	0.18	7	1.8	5.3	30	14	0.8	0.75
JBIR07140150-D070	●	1.5	7	0.18	7	2.8	6.3	30	14	0.8	0.75

● : Line up

JBBS-4N

Sleeve for internal coolant supply with 4 coolant holes

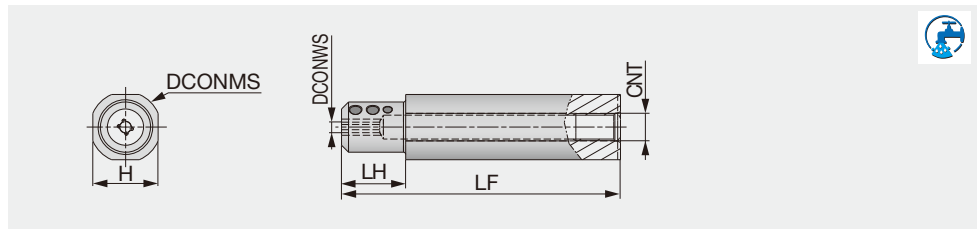

Designation	DCONMS	DCONWS	LF	LH	H	CNT
JBBS12-4-L80C-4N	12	4	80	10	10.3	Rc1/16
JBBS127-4-L80C-4N	12.7	4	80	10	11.6	Rc1/16
JBBS14-4-L80C-4N	14	4	80	10	12	Rc1/8
JBBS159-4-L100C-4N	15.875	4	100	10	14.58	Rc1/8
JBBS159-7-L100C-4N	15.875	7	100	10	14.58	Rc1/8
JBBS16-4-L100C-4N	16	4	100	10	15	Rc1/8
JBBS16-7-L100C-4N	16	7	100	10	15	Rc1/8
JBBS19-4-L100C-4N	19.05	4	100	20	17.2	Rc1/8
JBBS19-7-L100C-4N	19.05	7	100	20	17.2	Rc1/8
JBBS20-4-L100C-4N	20	4	100	20	18	Rc1/8
JBBS20-7-L100C-4N	20	7	100	20	18	Rc1/8
JBBS22-4-L100C-4N	22	4	100	20	20	Rc1/8
JBBS22-7-L100C-4N	22	7	100	20	20	Rc1/8
JBBS25-4-L100C-4N	25	4	100	23	23	Rc1/8
JBBS25-7-L100C-4N	25	7	100	23	23	Rc1/8
JBBS254-4-L100C-4N	25.4	4	100	23	23.4	Rc1/8
JBBS254-7-L100C-4N	25.4	7	100	23	23.4	Rc1/8

SPARE PARTS



Designation	Clamping screw	Wrench
JBBS**-4-L***C-4N	SSHM5-6PF-S	P-2.5
JBBS**-7-L***C-4N	SSHM5-4PF-S	P-2.5

JBBSA-C

Collet chuck sleeve with internal coolant supply

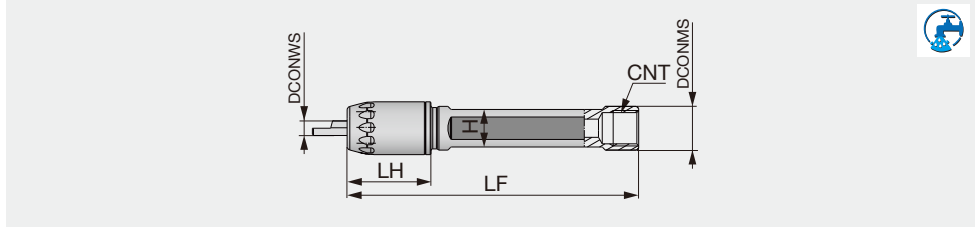

Designation	DCONMS	DCONWS	LF	LH	H	CNT
JBBSA12-4-L80C	12	4	80	23	10.3	Rc1/8
JBBSA127-4-L80C	12.7	4	80	23	11.6	Rc1/8
JBBSA14-4-L80C	14	4	80	23	12	Rc1/8
JBBSA159-4-L100C	15.875	4	100	23	14	Rc1/8
JBBSA159-7-L100C	15.875	7	100	23	14	Rc1/8
JBBSA16-4-L100C	16	4	100	23	14	Rc1/8
JBBSA16-7-L100C	16	7	100	23	14	Rc1/8
JBBSA19-4-L120C	19.05	4	120	23	17.2	Rc1/8
JBBSA19-7-L120C	19.05	7	120	23	17.2	Rc1/8
JBBSA20-4-L120C	20	4	120	23	18	Rc1/8
JBBSA20-7-L120C	20	7	120	23	18	Rc1/8
JBBSA22-4-L135C	22	4	135	23	20	Rc1/8
JBBSA22-7-L135C	22	7	135	23	20	Rc1/8
JBBSA25-4-L135C	25	4	120	23	23	Rc1/8
JBBSA25-7-L135C	25	7	120	23	23	Rc1/8
JBBSA254-4-L120C	25.4	4	120	23	23.4	Rc1/8
JBBSA254-7-L120C	25.4	7	120	23	23.4	Rc1/8

SPARE PARTS



Designation	Cap	Wrench
JBBSA**-4-L...	CAP-A-4	WRENCH-A-4
JBBSA**-7-L...	CAP-A-7	WRENCH-A-7

■ New sleeve with four coolant holes for optimal performance

- Optimum sleeve option for all boring operations. Sleeves with four coolant holes can be used with all TinyMini-Turn tools
- 4 streams of coolant jets are directed to the cutting point, improving chip evacuation
- Sufficient coolant supply eliminates chip bird-nesting on the tools or workpiece, enabling trouble-free, unattended operation over an extended time
- Significantly prolongs tool life

Internal coolant sleeve

First recommendation!



Excellent chip evacuation

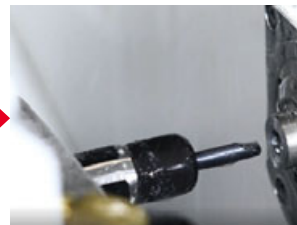

- No chip jamming
- No machine stoppage
- No downtime

Conventional (External coolant)

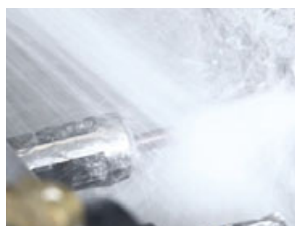

- Chip jamming
- Increased machine downtime



Sleeve for external coolant supply

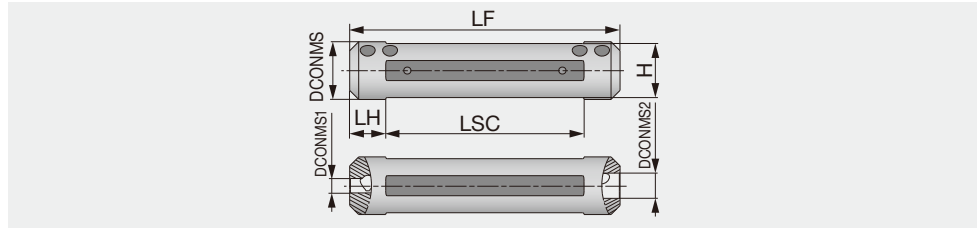

Designation	DCONMS	DCONWS1	DCONWS2	LF	LH	LSC	H
JBBS12-4-4	12	4	4	75	10	55	10.3
JBBS127-4-4	12.7	4	4	76.2	10	56.2	11.6
JBBS14-4-4	14	4	4	75	10	55	12
JBBS159-4-7	15.875	4	7	76.2	10	56.2	14
JBBS16-4-7	16	4	7	75	10	55	15
JBBS19-4-7	19.05	4	7	89	10	69	17.2
JBBS20-4-7	20	4	7	90	10	70	18
JBBS22-4-7	22	4	7	90	10	70	20
JBBS25-4-7	25	4	7	100	10	80	23
JBBS254-4-7	25.4	4	7	90	10	70	23.4

JBBS-C

Sleeve for internal coolant supply

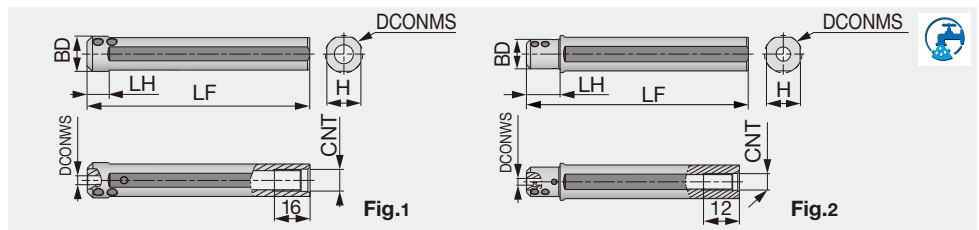

Designation	DCONMS	BD	DCONWS	LF	LH	H	CNT	Fig
JBBS159-4-L100C	15.875	15.875	4	100	10	14.58	Rc1/8	1
JBBS159-7-L100C	15.875	15.875	7	100	10	14.58	Rc1/8	1
JBBS16-4-L100C	16	16	4	100	10	15	Rc1/8	1
JBBS16-7-L100C	16	16	7	100	10	15	Rc1/8	1
JBBS19-4-L100C	19.05	17.5	4	100	20	17.2	Rc1/8	2
JBBS19-7-L100C	19.05	17.5	7	100	20	17.2	Rc1/8	2
JBBS20-4-L100C	20	17.5	4	100	20	18	Rc1/8	2
JBBS20-7-L100C	20	17.5	7	100	20	18	Rc1/8	2
JBBS22-4-L100C	22	17.5	4	100	20	20	Rc1/8	2
JBBS22-7-L100C	22	17.5	7	100	20	20	Rc1/8	2
JBBS25-4-L100C	25	18	4	100	23	23	Rc1/8	2
JBBS25-7-L100C	25	18	7	100	23	23	Rc1/8	2
JBBS254-4-L100C	25.4	18	4	100	23	23.4	Rc1/8	2
JBBS254-7-L100C	25.4	18	7	100	23	23.4	Rc1/8	2

SPARE PARTS



Designation	Clamping screw	Wrench
JBBS12-4-4, JBBS14-4-4 JBBS*-7-L100C	SSHM5-4PF-S	P-2.5
JBBS127-4-4, JBBS*-4-7 JBBS*-4-L100C	SSHM5-6PF-S	P-2.5

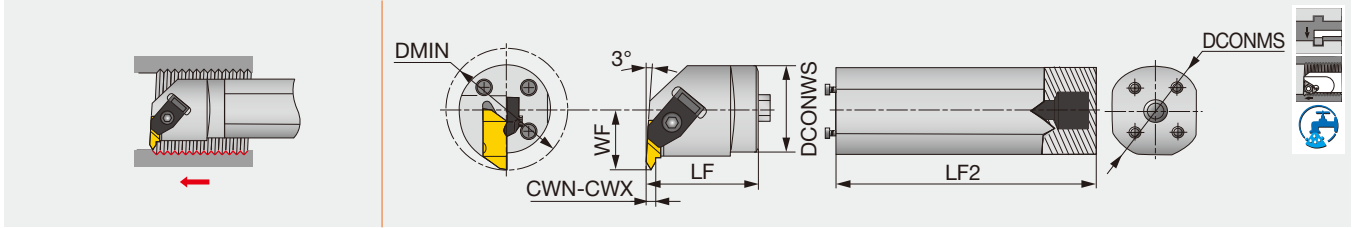

Designation	DMIN	DCONWS	LF	WF	Insert	Torque*
HS40-FLER3W	56.1	40	41.3	25.4	FLT-3L...	3
HS50-FLER3W	70.1	50	41.9	35	FLT-3L...	3

Torque* : Recommended clamping torque (N·m)

Note: Use the left-hand insert (FLT-3L...) for a right-hand holder (HS**-FLER...).

SPARE PARTS



Designation	Clamp	Clamping screw 2	Wrench
HS40-FLER3W	TF-73	S-412	5/32HEX
HS50-FLER3W	TF-73	S-412	5/32HEX

Shank

Designation	DCONMS	LF2
S-570-40M-40	40	273
S-570-50M-50	50	366

Spare parts



Designation	Clamping screw	Wrench
S-570-40M-40	SS100	5/32HEX
S-570-50M-50	SS94	1/4EX

TUNGST-CLAMP

A_M-FLER/L

Internal grooving and threading toolholder

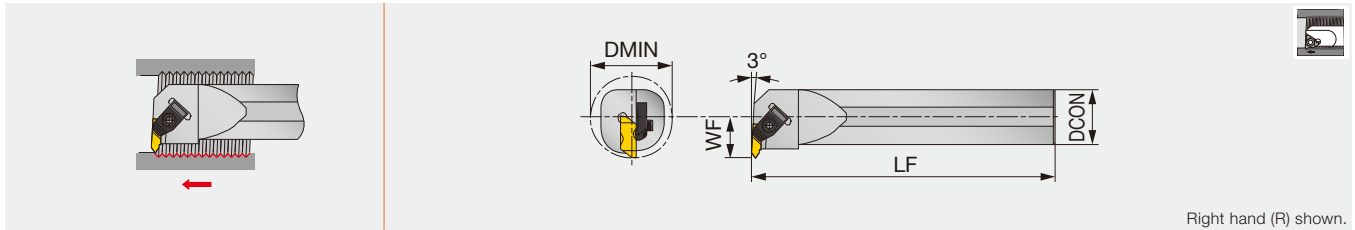

Right hand (R) shown.

Designation	Pitch	DMIN	DCON	LF	WF	Insert
A25M-FLER/L3	2.11 - 5.08	34.9	25	300	17.7	FLT-3...
A32M-FLER/L3	2.11 - 5.08	44.5	32	350	22.1	FLT-3...
A40M-FLER3	2.11 - 5.08	50.8	40	350	24.5	FLT-3L...

TUNGTHREAD

HS-LNFR-53

Head exchangeable internal threading, for single-sided lay down inserts

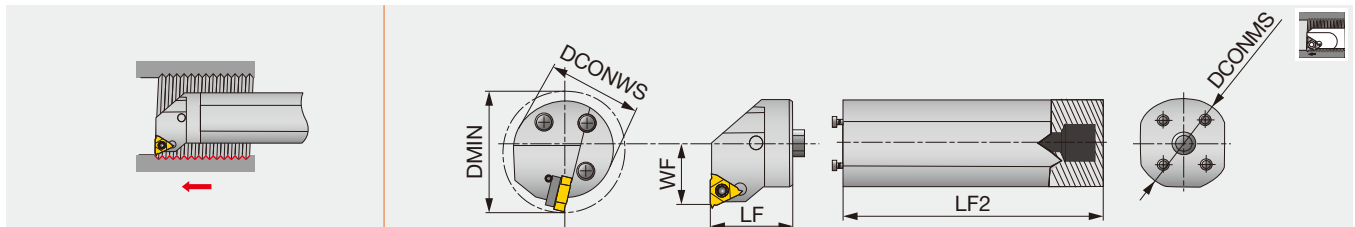

Designation	DMIN	DCONWS	WF	LF	Insert
HS40-LNFR-53	50	40	28.7	41.3	L535B**INT-FC
HS50-LNFR-53	63	50	32.7	41.3	L535B**INT-FC

SPARE PARTS

Designation	Lock pin	Clamp 1	Clamp 2	Clamping screw 1	Clamping screw 2	Wrench
A**M-FLER3	-	TF-73	-	S-412	-	5/32HEX
A**M-FLEL3	-	TF-72	-	S-412	-	5/32HEX
HS**-LNFR-53	NL-56	-	TC-250	-	STC-11	1/8HEX

Shank

Designation	DCONMS	LF2
S-570-40M-40	40	273
S-570-50M-50	50	366

SPARE PARTS

Designation	Clamping screw	Wrench
S-570-40M-40	SS100	5/32HEX
S-570-50M-50	SS94	1/4EX

Reference pages: A_M-FLER/L : Inserts → [E014](#)
 HS-LNFR-53 : Inserts → [E032](#)

Head exchangeable internal threading toolholder, for double-sided lay down inserts

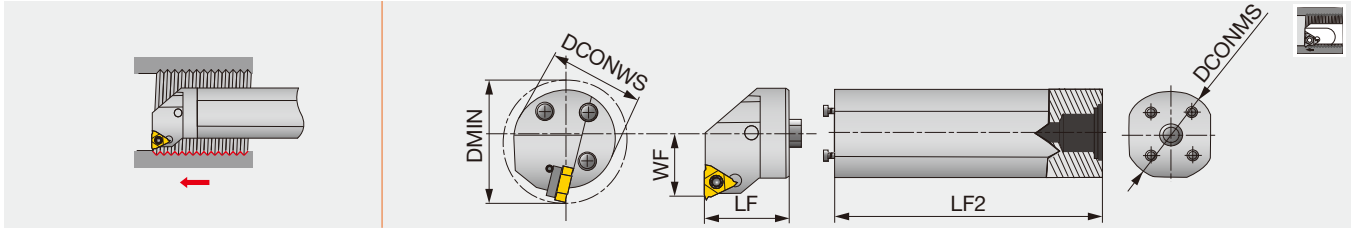

Designation	DMIN	DCONWS	WF	LF	Insert
HS40-LNFR-54API	50	40	27	32	LDS54**FT-CB#...
HS50-LNFR-54API	63	50	35	40	LDS54**FT-CB#...

Shank

Designation	DCONMS	LF2
S-570-40M-40	40	273
S-570-50M-50	50	366

SPARE PARTS

Designation	Clamping screw	Wrench
S-570-40M-40	SS100	5/32HEX
S-570-50M-50	SS94	1/4EX

HS-MTHOR

Multi-clamp internal threading toolholder, for on edge inserts

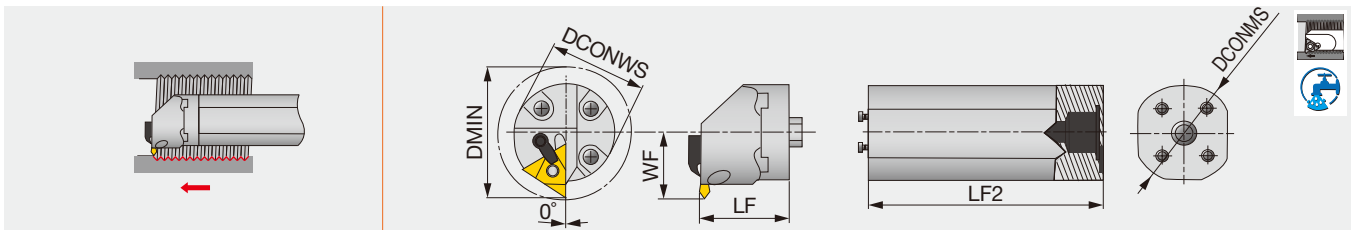

Designation	DMIN	DCONWS	WF	LF	Insert
HS40-MTHOR-4	66.7	40	25.9	32	TNM*43...
HS50-MTHOR-4	73	50	35.9	40	TNM*43...
HS40-MTHOR-5	81.3	40	30.6	32	TNM*54...
HS50-MTHOR-5	82.6	50	35.9	40	TNM*54...

Shank

Designation	DCONMS	LF2
S-570-40M-40	40	273
S-570-50M-50	50	366

SPARE PARTS

Designation	Clamping screw	Wrench
S-570-40M-40	SS100	5/32HEX
S-570-50M-50	SS94	1/4EX

SPARE PARTS

Designation	Lock pin	Clamp	Clamping screw	Wrench
HS40-LNFR-54API	H410-1	TC-250	STC-11	1/8HEX
HS50-LNFR-54API	NL-56	TC-250	STC-11	1/8HEX
HS**-MTHOR-4	NL-44	TC-190	STC-5	3/32HEX
HS**-MTHOR-5	NL-56	TC-250	STC-11	1/8HEX

Reference pages: HS-LNFR-54API : Inserts → **E035**
 HS-MTHOR : Inserts → **E029 - E031, E033**



TT-type pin-lock internal threading toolholder

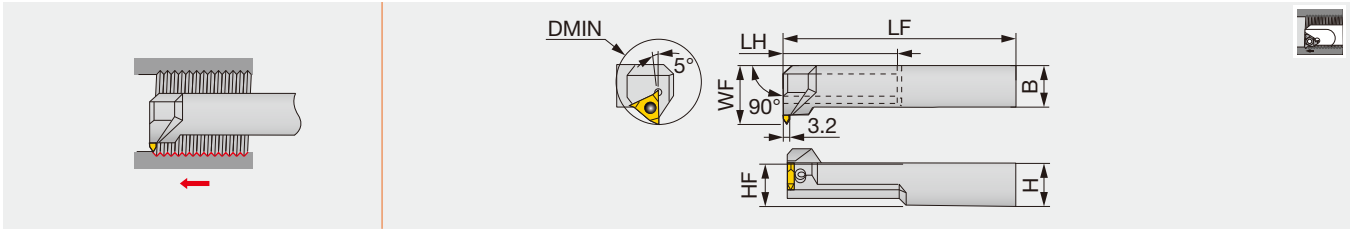

Designation	DMIN	H	B	LF	LH	HF	WF	Insert
TT-2525RI	50	25	25	200	70	25	35	TTL42...

Note: Use the left-hand insert (TTL42...) for a right-hand holder (TT-2525RI).

SI-CLHOR

Internal threading toolholder, for chaser inserts

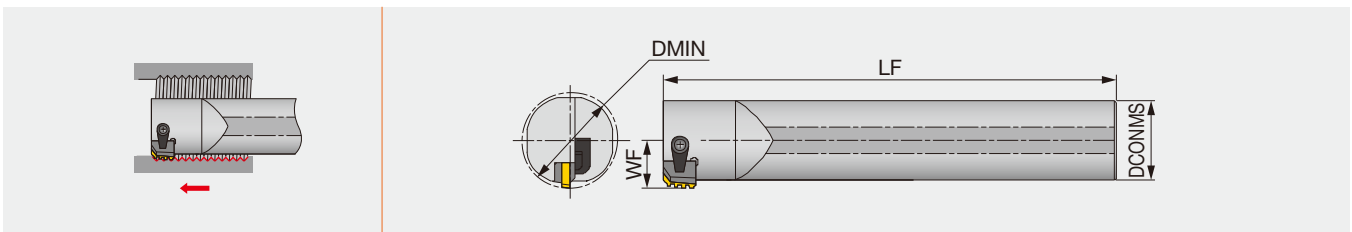

Designation	DMIN	DCONMS	WF	LF	Insert
SI-CLHOR-40M6	50.8	40	23.16	400	CR...

SPARE PARTS

Designation	Clamp	Clamp	Right-left screw	Wrench
TT-2525RI	CP91	-	DS-6	P-3
SI-CLHOR-40M6	-	TC-311	STC-8	5/32HEX

Reference pages: TT-RI : Inserts → [E014](#), [E016](#)

SI-CLHOR : Inserts → [E026](#), [E031](#)

Technical Guide

- Relationship between pitch, depth of cut and number of passes for external metric threading

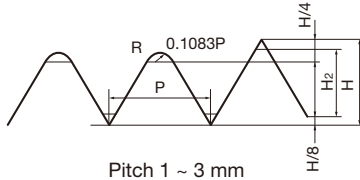

Note: Maximum machinable pitch is 3 mm.

Part assembly

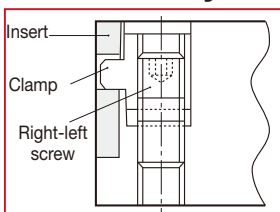

Number of passes	P	1	1.25	1.5	1.75	2	2.5	3
	H ₂	0.6	0.76	0.92	1.09	1.25	1.57	1.9
	H	0.866	1.083	1.299	1.516	1.732	2.165	2.598
1	0.25	0.3	0.3	0.3	0.35	0.4	0.4	
2	0.15	0.2	0.25	0.25	0.25	0.3	0.35	
3	0.1	0.1	0.15	0.2	0.2	0.25	0.28	
4	0.05	0.06	0.1	0.1	0.16	0.2	0.2	
5	0.05	0.06	0.05	0.1	0.1	0.15	0.2	
6		0.06	0.05	0.07	0.07	0.1	0.13	
7			0.02	0.05	0.05	0.07	0.1	
8				0.02	0.02	0.05	0.1	
9					0.02	0.03	0.05	
10						0.02	0.05	
11							0.02	
12							0.02	

STANDARD CUTTING CONDITIONS

TUNGTHREAD

ISO	Workpiece material	Hardness	Cutting speed: Vc (m/min)						
			AH8015	T05HP	AH725	T313V	NS9530	TH10	BX330
P	Steel / Alloy steel S45C, SCM440, etc. C45, 42CrMoS4, etc.	< 200HB	80 - 180	100 - 200	80 - 180	100 - 200	150 - 200	-	-
		> 200HB	60 - 160	100 - 150	60 - 160	100 - 150	100 - 170	-	-
M	Stainless steel SUS304, etc. X5CrNi18-9, etc.	-	50 - 130	70 - 130	50 - 130	70 - 130	-	-	-
K	Cast iron FC250, FC300, etc. 250, 300, etc.	-	60 - 150	70 - 150	50 - 100	70 - 150	-	70 - 90	-
N	Non-ferrous metal	-	-	-	-	-	100 - 500	-	-
S	Superalloys Ti-6Al-4V, Inconel718, etc.	-	20 - 80	-	-	-	10 - 40	-	-
H	Hardened steel	50 - 60HRC	-	-	-	-	10 - 30	50 - 200	-

TETRAMCUT

TCT18R/L / TCT18FR

ISO	Workpiece material	Hardness	Priority	Grade	Cutting speed Vc (m/min)	Pitch (mm)	Threads per inch (TPI)
P	Steel / Alloy steel S45C, SCM440, etc. C45, 42CrMoS4, etc.	< 200HB	First choice	SH725	60 - 150	0.4 - 2.0	64 - 12
			Fracture resistance	AH725	60 - 150	0.8 - 3.0	32 - 8
		> 200HB	First choice	SH725	60 - 150	0.4 - 2.0	64 - 12
			Fracture resistance	AH725	60 - 150	0.8 - 3.0	32 - 8
M	Stainless steel SUS304, etc. X5CrNi18-9, etc.	-	First choice	SH725	50 - 80	0.4 - 2.0	64 - 12
		-	Fracture resistance	AH725	50 - 80	0.8 - 3.0	32 - 8
K	Cast iron FC250, FC300, etc. 250, 300, etc.	-	First choice	AH725	50 - 100	0.8 - 3.0	32 - 8
		-	Sharpness	SH725	50 - 100	0.4 - 2.0	64 - 12
S	Superalloys Ti-6Al-4V, Inconel718, etc.	-	First choice	SH725	30 - 100	0.4 - 2.0	64 - 12
		-	Fracture resistance	AH725	30 - 100	0.8 - 3.0	32 - 8

DUOJUST

ISO	Workpiece material	Hardness	Grade	Cutting speed Vc (m/min)	Pitch (mm)	Threads per inch (TPI)
P	Steel / Alloy steel S45C, SCM440, etc. C45, 42CrMoS4, etc.	< 200HB	SH725	50 - 200	0.2 - 1.5	127 - 16
		> 200HB	SH725	50 - 200	0.2 - 1.5	127 - 16
M	Stainless steel SUS304, etc. X5CrNi18-9, etc.	-	SH725	50 - 200	0.2 - 1.5	127 - 16
N	Aluminium alloys A5056, A6061, etc.	-	SH725	150 - 200	0.2 - 1.5	127 - 16
	Copper alloy C2600, C280C, etc.	-	SH725	100 - 200	0.2 - 1.5	127 - 16
S	Superalloys Ti-6Al-4V, Inconel718, etc.	-	SH725	30 - 80	0.2 - 1.5	127 - 16

Reference pages: TungThread : Inserts → **E010 - E011, E015 - E035**
 External toolholders → **E036 - E040, E051 - E053**
 Internal toolholders → **E054 - E056, E064 - E066**
 TetraMini-Cut: Inserts → **E012**, External toolholders → **E041 - E045**
 DuoJust-Cut : Inserts → **E012**, External toolholders → **E047 - E048**



Technical Guide

STANDARD CUTTING CONDITIONS

TUNGT-CLAMP

ISO	Workpiece material	Hardness	Grade	Application	Cutting speed Vc (m/min)	Pitch (mm)	Threads per inch (TPI)
P	Steel / Alloy steel S45C, SCM440, etc. C45, 42CrMoS4, etc.	< 200HB	AH725	Threading	80 - 180	Internal 2.11 - 5.08 External 1.27 - 4.23	Internal 5 - 12 External 6- 20
		> 200HB	AH725	Threading	60 - 160	Internal 2.11 - 5.08 External 1.27 - 4.23	Internal 5 - 12 External 6- 20
M	Stainless steel SUS304, etc. X5CrNi18-9, etc.	-	AH725	Threading	50 - 130	Internal 2.11 - 5.08 External 1.27 - 4.23	Internal 5 - 12 External 6- 20

TINYM^{INI}TURN

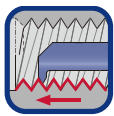

Internal threading

ISO	Workpiece material	Hardness	Grade	Cutting speed Vc (m/min)	Number of passes				
					Pitch (mm)				
					0.5	0.75	1	1.25	1.5
P	Steel / Alloy steel S45C, SCM440, etc. C45, 42CrMoS4, etc.	< 200HB	SH730, SH725	40 - 140	6 - 8	8 - 10	10 - 12	12 - 15	15 - 18
		> 200HB	SH730, SH725	40 - 140	6 - 8	8 - 10	10 - 12	12 - 15	15 - 18
M	Stainless steel SUS304, etc. X5CrNi18-9, etc.	-	SH730, SH725	40 - 140	8	10	12	15	18
K	Cast iron FC250, FC300, etc. 250, 300, etc.	-	SH730, SH725	30 - 100	7	9	12	14	17
N	Aluminium alloys, Copper alloy Si < 12%	-	SH730, SH725	90 - 200	6	8	10	12	15

Reference pages: TungT-Clamp : Inserts → **E014**, External toolholders → **E050**
 Internal toolholders → **E063 - E064**
 TinyMini-Turn: Solid carbide boring bars → **E059**

IMPORTANT - Replacement of shim

AH725 insert has 2 types of shims according to the chipbreaker geometry. Please find an appropriate shim in the table below. When using a wrong shim, the insert seating may become unstable or the tool life may be shortened.

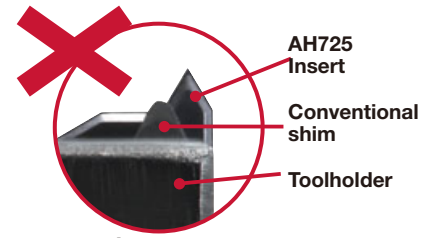

Improper combination

Interchangeable shim (Insert size: 16)

Toolholder screw type	Lead angle	External		Internal	
		① Conventional shim	① Standard (New)	② Conventional shim	② Standard (New)
Dual clamping methods of screw-on and clamp-on	4°	GXE16-4DT	AE16-4DT	GXN16-4DT	AN16-4DT
	3°	GXE16-3DT	AE16-3DT	GXN16-3DT	AN16-3DT
	2°	GXE16-2DT	AE16-2DT	GXN16-2DT	AN16-2DT
	1° (Standard)	GX16-1DT	A16-1DT	GX16-1DT	A16-1DT
	0°	GXE16-0DT	AE16-0DT	GXN16-0DT	AN16-0DT
	-1°	GXE16-99DT	AE16-99DT	GXN16-99DT	AN16-99DT
	-2°	GXE16-98DT	AE16-98DT	GXN16-98DT	AN16-98DT
Clamp-on	4°	GXE16-4	AE16-4	GXN16-4	AN16-4
	3°	GXE16-3	AE16-3	GXN16-3	AN16-3
	2°	GXE16-2	AE16-2	GXN16-2	AN16-2
	1° (Standard)	GXE16-1	A16-1	GXN16-1	A16-1
	0°	GXE16-0	AE16-0	GXN16-0	AN16-0
	-1°	GXE16-99	AE16-99	GXN16-99	AN16-99
	-2°	GXE16-98	AE16-98	GXN16-98	AN16-98

Shim to be replaced (Insert size: 16)

Thread	External			Internal		
	Designation	Grade	Replacement	Designation	Grade	Replacement
ISO			① Conventional shim ① Standard (New)	16IR15ISO-B	AH725	② Conventional shim ② Standard (New)
				16IR175ISO-B	AH725	
				16IR20ISO-B	AH725	
55°	16ERAG55-B	AH725	① Conventional shim ① Standard (New)	16IRAG55-B	AH725	② Conventional shim ② Standard (New)
				16IRG55-B	AH725	
				16IRAG60-B	AH725	
60°	16ERA60-B	AH725	① Conventional shim ① Standard (New)	16IRA60-B	AH725	② Conventional shim ② Standard (New)
				16IRG60-B	AH725	
				16IR18UN-B	AH725	
UN			① Conventional shim ① Standard (New)	16IR16UN-B	AH725	② Conventional shim ② Standard (New)
				16IR14UN-B	AH725	
W			① Conventional shim ① Standard (New)	16IR16W-B	AH725	② Conventional shim ② Standard (New)
				16IR14W-B	AH725	
PT			① Conventional shim ① Standard (New)	16IR14PT-B	AH725	② Conventional shim ② Standard (New)
NPT	16ER8NPT-B	AH725		16IR14NPT-B	AH725	
			① Conventional shim ① Standard (New)	16IR115NPT-B	AH725	② Conventional shim ② Standard (New)

Want to learn more about threads and thread machining?

Visit this special website for the latest information on thread machining.

The website provides information on:

- Basic knowledge on threads and thread machining
- Threading tool selection guide and the latest machining techniques
- F.A.Q. and troubleshooting guide

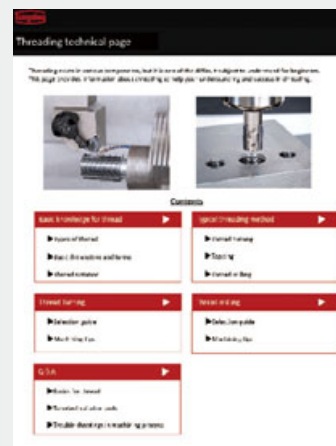

Scan this QR code to access the website

Parting, Grooving



Parting, Grooving - Content structure

- Products are listed by application.
- Each item is listed by product series.
- Internal grooving tools are listed according to the order of the minimum machining diameter (from small to larger).

How to use the page

Method ①

Select the application (①) at the left end of each page and choose a designation you need (④) in the dimension table (③). Applicable inserts are shown in (⑥).

TETRAMCUT
STCR/L-18
Precision grooving tools with uniquely shaped insert for swiss type machine and general lathes

Designation	CW	CWx	H	B	LF	LH	HF	WF	HBH	Insert	Torque*	Fig.
STCR.L1010X18	0.33	3.18	10	10	120	18.5	10	10	4.5	TC18...	1.2	1
STCR.L1212P18	0.33	3.18	12	12	85	18.5	12	12	2.5	TC18...	1.2	1
STCR.L1212S18	0.33	3.18	12	12	100	18.5	12	12	2.5	TC18...	1.2	1
STCR.L1616X18	0.33	3.18	16	16	120	18.5	16	16	-	TC18...	1.2	1
STCR.L2020H18	0.33	3.18	20	20	100	18.5	20	20	-	TC18...	1.2	1
STCR.L2020P18	0.33	3.18	20	20	100	23	20	25	-	TC18...	1.2	2
STCR.L2525S18	0.33	3.18	25	25	135	23	25	30	-	TC18...	1.2	2

STCR/L-18-CHP
External grooving and threading toolholder, high pressure coolant compatible

Method ②

Select the tool series name on **F004 - F005** and check the details on the product page.

Machining Overview

External grooving F012 page

Max. groove depth: 6.4 mm

- TETRAMCUT** F044 page
- ADDFCUT** F059 page
- GBR/L** F009 page

Max. groove depth: 50 mm

- TUNGECUT** F014 page
- ADDFCUT** F012 page
- DUOJCUT** F071 page
- TUNGECUT** F095 page
- MYT SERIES** F077 page

Internal grooving F120 page

General internal grooving and turning

- ADDFCUT** F120 page
- TUNGECUT** F126 page
- ADDFCUT** F122 page
- MYT SERIES** F148 page
- GBR/L** F156 page
- SNE / CNE** F159 page

F004 tungaloy.com

Method ③

Select the tool series or the tool specification from Quick Guide on **F006 - F007** and see the details on each page.

Quick Guide

Series	Insert shape	External grooving			Parting		
		CW (mm)	CDX (mm)	Priority Page	CW (mm)	CUT/TA (mm)	Priority Page
ADDFCUT		2-5	33	○ F012	2-5	120	○ Red F024
ADDFCUT							○
TUNGECUT		1.2-8	35	○ Red F014	1.2-8	120	○ F029
TETRAMCUT		0.5-4	10	○ Blue F059	0.5-4	20	○ Blue F059
TETRAMCUT		0.33-3	3.5	○ Blue F044	0.33-3	7	○ Blue F044
DUOJCUT		0.6-2.5	10.5	○ F071	0.6-2	20	○ F047
GBR/L		0.33-4.5	5	○ F099			
MYT SERIES		2-5	25	○ F077	2-5	120	○ F052
EASYMCUT							
TUNGECUT		10-25	50	○ F095			
SNE / CNE							
XG/XX		1-4.5 (GDR/L)	6	○ F105			
Other		1-3 (P1.0-CB)	4.07	○ F091			
		1-2.25 (GTON)	1.8	○ F093			
		1.15-4.2 (ELR/L)	4	○ F103			

F006 tungaloy.com

2 TETRAMCUT STCR/L-18

Precision grooving tools with uniquely shaped insert for swiss type machine and general lathes

Designation	CWN	CWX	H	B	LF	LH	HF	WF	HBH	Insert	Torque*	Fig.
STCR/L1010K18	0.33	3.18	10	10	120	18.5	10	10	4.5	TC18...	1.2	1
STCR/L1212F18	0.33	3.18	12	12	85	18.5	12	12	2.5	TC18...	1.2	1
STCR/L1212K18	0.33	3.18	12	12	100	18.5	12	12	2.5	TC18...	1.2	1
STCR/L1616K18	0.33	3.18	16	16	120	18.5	16	16	-	TC18...	1.2	1
STCR/L2020H18	0.33	3.18	20	20	100	18.5	20	20	-	TC18...	1.2	1
STCR/L2020K18	0.33	3.18	20	20	100	23	20	25	-	TC18...	1.2	2
STCR/L2525K18	0.33	3.18	25	25	135	23	25	30	-	TC18...	1.2	2

10 tungaloy.com

8 INSERTS TCS18R/L (3D chipbreaker, honed edge)

Designation	HAND	CW	Wd	RE	ANVTZ	CDX
TCS18R100-010	R	1	0.1	●		2
TCS18R100-010	L	1	0.1	●		2
TCS18R120-010	R	1.2	0.1	●		2
TCS18R120-010	L	1.2	0.1	●		2
TCS18R125-010	R	1.25	0.1	●		2
TCS18R125-010	L	1.25	0.1	●		2
TCS18R125-020	R	1.25	0.2	●		2
TCS18R125-020	L	1.25	0.2	●		2
TCS18R130-020	R	1.3	0.2	●		3.5
TCS18R130-020	L	1.3	0.2	●		3.5
TCS18R140-010	R	1.4	0.1	●		3.5
TCS18R140-010	L	1.4	0.1	●		3.5
TCS18R140-020	R	1.4	0.2	●		3.5
TCS18R140-020	L	1.4	0.2	●		3.5
TCS18R145-010	R	1.45	0.1	●		3.5
TCS18R145-010	L	1.45	0.1	●		3.5
TCS18R150-010	R	1.5	0.1	●		3.5
TCS18R150-010	L	1.5	0.1	●		3.5
TCS18R150-020	R	1.5	0.2	●		3.5
TCS18R150-020	L	1.5	0.2	●		3.5
TCS18R160-020	R	1.6	0.2	●		3.5
TCS18R160-020	L	1.6	0.2	●		3.5
TCS18R170-020	R	1.7	0.2	●		3.5
TCS18R170-020	L	1.7	0.2	●		3.5
TCS18R175-010	R	1.75	0.1	●		3.5
TCS18R175-010	L	1.75	0.1	●		3.5
TCS18R175-020	R	1.75	0.2	●		3.5
TCS18R175-020	L	1.75	0.2	●		3.5
TCS18R185-020	R	1.85	0.2	●		3.5
TCS18R185-020	L	1.85	0.2	●		3.5
TCS18R185-020	R	1.85	0.2	●		3.5
TCS18R185-020	L	1.85	0.2	●		3.5
TCS18R200-010	R	2	0.1	●		3.5
TCS18R200-010	L	2	0.1	●		3.5
TCS18R200-020	R	2	0.2	●		3.5
TCS18R200-020	L	2	0.2	●		3.5
TCS18R225-020	R	2.25	0.2	●		3.5
TCS18R225-020	L	2.25	0.2	●		3.5
TCS18R230-020	R	2.3	0.2	●		3.5
TCS18R230-020	L	2.3	0.2	●		3.5
TCS18R250-010	R	2.5	0.1	●		3.5
TCS18R250-010	L	2.5	0.1	●		3.5

Reference pages: Toolholders → F044 - F050, Standard cutting conditions → F058

10 tungaloy.com

9 STANDARD CUTTING CONDITIONS

TCS18R/L, TCL18R/L (3D chipbreaker), TCG18R/L (honed edge), TCG18R/L (Full Ft)

ISO	Workpiece materials	Grade	Cutting speed Vc (m/min)	TCL18	TCG18	Feed: f (mm/rev)	TCG18
P	Low carbon steel	AH7025	80 - 180	0.03 - 0.12	0.04 - 0.16	0.04 - 0.14	
	S15C, S45C, etc., C15E4, E275A, etc.						
	Carbon steel, alloy steel	AH7025	80 - 180	0.03 - 0.12	0.04 - 0.16	0.04 - 0.14	
M	Prehardened steel	AH7025	80 - 180	0.03 - 0.12	0.04 - 0.16	0.04 - 0.14	
	SAE52100, etc., CR5, 42CrMo4, etc.						
	Stainless steel	AH7025	50 - 120	0.03 - 0.12	0.04 - 0.16	0.04 - 0.14	
K	Grey cast iron	AH7025	50 - 180	0.03 - 0.12	0.04 - 0.16	0.04 - 0.14	
	FC250, FC300, etc., 250, 300, etc., GG25, GG30, etc.						
	Ductile cast iron	AH7025	50 - 180	0.03 - 0.12	0.04 - 0.16	0.04 - 0.14	
S	Titanium alloys	AH7025	30 - 60	0.03 - 0.12	0.04 - 0.16	0.04 - 0.14	
	TC400, etc., 400-18S, etc., GG40, etc.						
	Superalloys	AH7025	20 - 40	0.03 - 0.12	0.04 - 0.16	0.04 - 0.14	
Inconel718, etc.							

TCP18R/L (lightly honed edge), TCP18R/L-F (sharp edge)

ISO	Workpiece materials	Priority	Grades	Cutting speed Vc (m/min)	Feed f (mm/rev)
P	Low carbon steel	First choice	SH725	80 - 180	0.03 - 0.1
	S15C, S45C, etc., C15E4, E275A, etc.	Toughness	AH725	80 - 180	0.03 - 0.1
	Carbon steel, alloy steel	First choice	SH725	80 - 180	0.03 - 0.1
M	Prehardened steel	First choice	SH725	80 - 180	0.03 - 0.1
	SAE52100, etc., CR5, 42CrMo4, etc.	Toughness	AH725	80 - 180	0.03 - 0.1
	Stainless steel	First choice	SH725	50 - 120	0.03 - 0.1
K	Grey cast iron	First choice	SH725	50 - 180	0.03 - 0.1
	FC250, FC300, etc., 250, 300, etc., GG25, GG30, etc.	Sharpness	SH725	50 - 180	0.03 - 0.1
	Ductile cast iron	First choice	SH725	50 - 180	0.03 - 0.1
S	Titanium alloys	First choice	SH725	30 - 80	0.03 - 0.1
	TC400, etc., 400-18S, etc., GG40, etc.	Sharpness	SH725	50 - 180	0.03 - 0.1
	Superalloys	First choice	AH725	30 - 80	0.03 - 0.1
Inconel718, etc.					

- 1 : Application
- 2 : Tool series name
- 3 : Dimension table
- 4 : Toolholder designation
- e.g. right-hand, 12x12 mm square shank
- **STC**R **1212**F18
- 5 : Dimension (conforming to ISO13399)
- 6 : Applicable insert
- 7 : Spare parts
- 8 : Insert
- 9 : Standard cutting conditions
- 10 : Reference pages

When ordering

- Please specify the designation and quantity for toolholders.
e.g. **CTER2020-4T25 ... 1**
- Please specify the designation and quantity for shank and adapter set when ordering both.
e.g. **CHSR2020-CHP ... 1, CAER-3T20-CHP... 1** (one shank per package, one adapter per package)
* Clamp screw for adapter is included.
- Please specify the designation, grade, and quantity for inserts.
e.g. **DGS3-020 AH7025 ... 10** (10 inserts per package)
* You will find a note if the number per package is not 10.

Machining Overview

External grooving

F012 page

Max. groove depth: 6.4 mm

Economy **TETRAMCUT** F044 page

Economy **TETRAFCUT** F059 page

GBR/L F099 page



Max. groove depth: 50 mm

First choice **TUNG CUT** F014 page

ADD FCUT F012 page

DUO JCUT F071 page

TUNG H^{MAX} GROOVE F095 page

MY-T SERIES F077 page



Internal grooving

F120 page

General internal grooving and turning

First choice **ADD^{INTERNAL} CUT** F120 page

TUNG CUT F126 page

ADD FCUT F122 page

MY-T SERIES F146 page

GBR/L F156 page

SNG / CNG F159 page

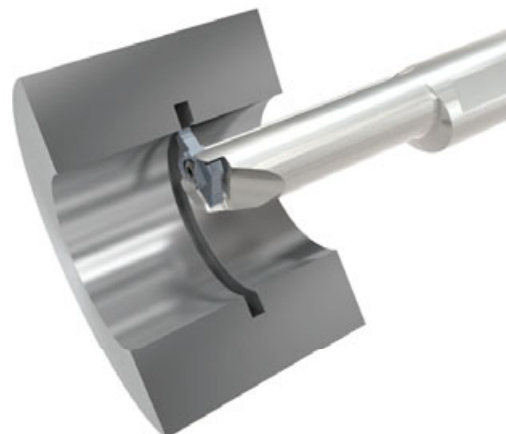

Face grooving

F168 page

First choice	TUNGCUT	F172 page
	EASYM^{ULTRA}CUT	F168 page
Economy	TETRAM^{NC}CUT	F199 page
	MY-T SERIES	F214 page

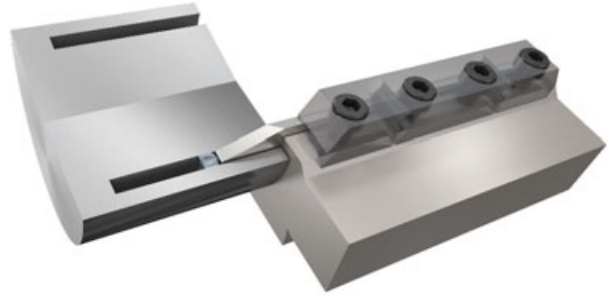

Parting







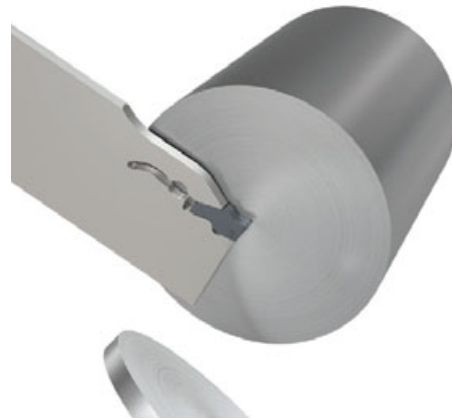



F224 page

General parting

First choice	ADD^{FACE}FCUT	F224 page
	TUNGCUT	F229 page
Economy	TETRA^{FACE}FCUT	F059 page
Economy	TETRAM^{NC}CUT	F044 page
	DUO^{JUST}CUT	F247 page
	MY-T SERIES	F252 page



Quick Guide

Series	Insert shape	External grooving				Parting			
						CW (mm)	CUTDIA (mm)	Priority	Page
		CW (mm)	CDX (mm)	Priority	Page				
ADDF^{ORCE}CUT		2 - 5	33	◎	F012	2 - 5	120	First choice ◎	F224
ADD^{INTERNAL}CUT									
TUNGCUT		1.2 - 8	35	First choice ◎	F014	1.2 - 8	120	◎	F229
TETRA^{ORCE}CUT		0.5 - 4	10	Economy ◎	F059	0.5 - 4	20	Economy ◎	F059
TETRA^{MCUT}		0.33 - 3	3.5	Economy ◎	F044	0.33 - 3	7	Economy ◎	F044
DUO^{JUST}CUT		0.6 - 2.5	10.5	◎	F071	0.6 - 2	20	◎	F247
GBR/L		0.33 - 4.5	5	○	F099				
MY-T SERIES		2 - 5	25	○	F077	2 - 5	120	○	F252
EASY^{ULTI}M^{CUT}									
TUNG^{H^{MAX}}GROOVE		10 - 25	50	◎	F095				
SNG / CNG									
XG/XN		1 - 4.5 (XGR/L)	6	○	F105				
Other		1 - 3 (FLG-CB)	4.07	○	F091				
		1 - 2.25 (GTGN)	1.8	○	F093				
		1.15 - 4.2 (GLR/L)	4	○	F103				

⊙ : First choice
○ : Usable

Face grooving						Internal grooving					Profiling (Full-R)				Turning				
CW (mm)	CDX (mm)	DAXN (mm)	Priority	Page		CW (mm)	CDX (mm)	DMIN (mm)	Priority	Page	CW (mm)	CDX (mm)	Priority	Page	CW (mm)	CDX (mm)	Priority	Page	
						2-4	32	55	⊙	F122									
						0.5-3	3	10.5	First choice ⊙	F120									
2-6	25	25	First choice ⊙	F172		2-8	10	25	⊙	F126	2-8	35	First choice ⊙	F014 F262	2-8	35	First choice ⊙	F014	
											1.57-3	6.4	Economy ⊙	F059					
0.33-3	3	6	Economy ⊙	F199							1-3.18	3.5	Economy ⊙	F044					
															2-2.5 (JDX)	6	⊙	F071	
						0.33-4.5	2.5	35	○	F156	1-4	5	○	F099					
3-5	22	30	○	F214		3-5	6	25	○	F146	3-5	25	○	F077	3-5	25	○	F077	
4-6	65	30	⊙	F168															
						1-3.5	3	8	○	F159									
1-4.5 (XNR/L)	6	55	○	F222		1-4.5 (XGR/L)	6	55	○	F166									
						1-3 (FLG-CB)	4.07	34.9	○	F152									
						1-2.25 (GTGN)	1.8	24	○	F154									



Highly rigid self-clamping system improves productivity for deep grooving and parting-off operations

- ① The stopper supporting the insert bottom ensures secure edge position for excellent repeatability
- ② The pocket is designed to securely spring-clip the insert with three contact faces for stability
- ③ Smooth uninterrupted chip flow is possible thanks to two variations of effective 3D chipbreakers

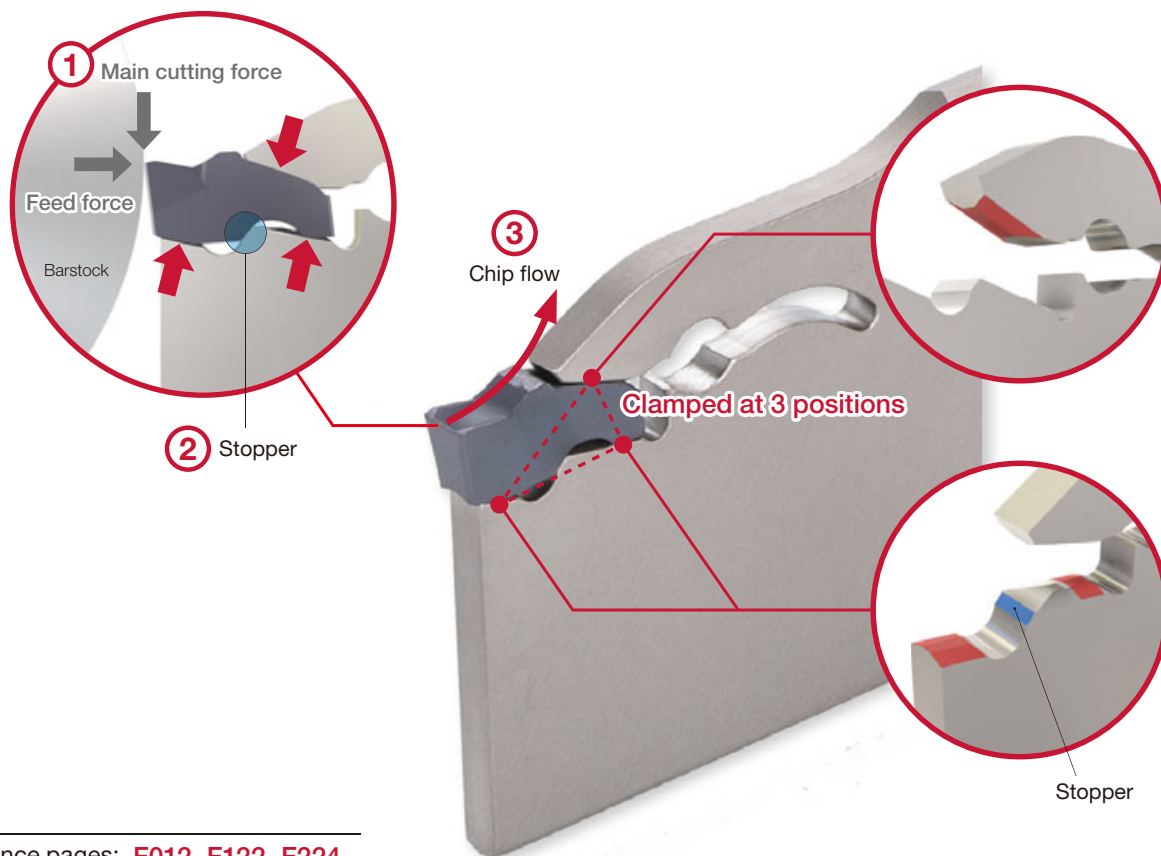

Reference pages: [F012](#), [F122](#), [F224](#)

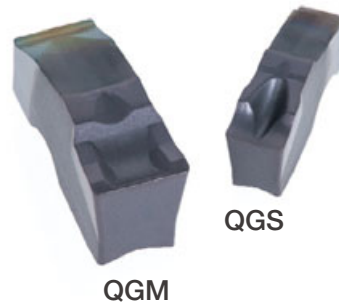

TUNGFBLADE

Strong holder design ensures tool stability and productivity gains during demanding cutting conditions

The blade provides reduced tooling cost with three insert pockets, while its strong backing beneath the insert withstands heavy cutting loads during machining.

Economical blade with three insert pockets.

Specially designed tool block has two contact faces to provide enhanced tool rigidity.

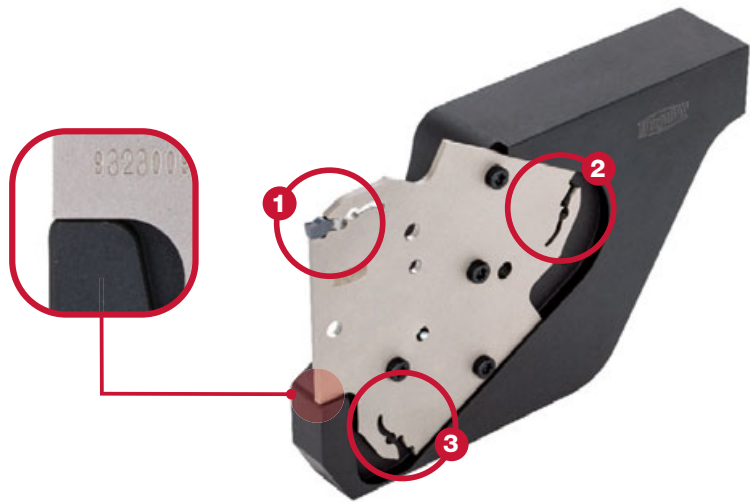

With much thicker support than existing grooving blades, tool deflection and chatter are minimized even at higher feed rates.

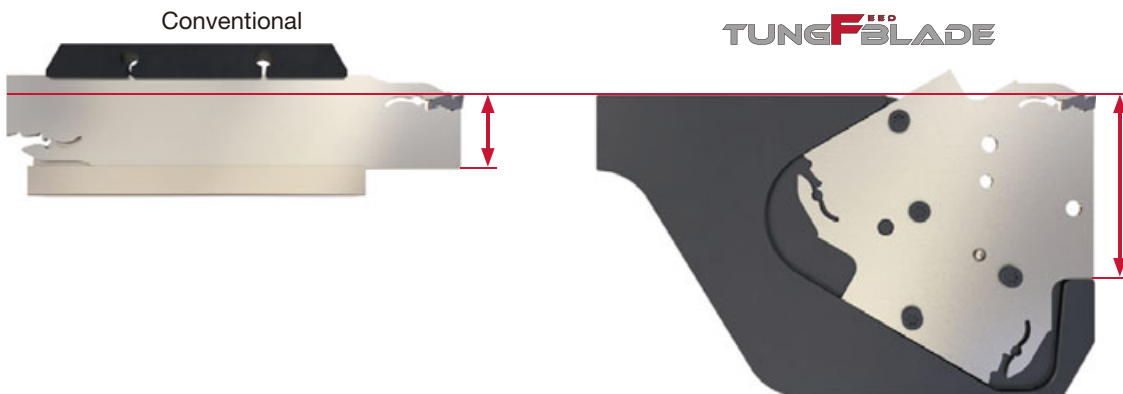

QSG blade + CHTBR/L tool block

Reference pages: **F226, F234, F235**



Unique insert clamping system ensures high indexing repeatability and clamping rigidity

- 1** The insert is supported at three optimized positions for rigid clamping and superior repeatability

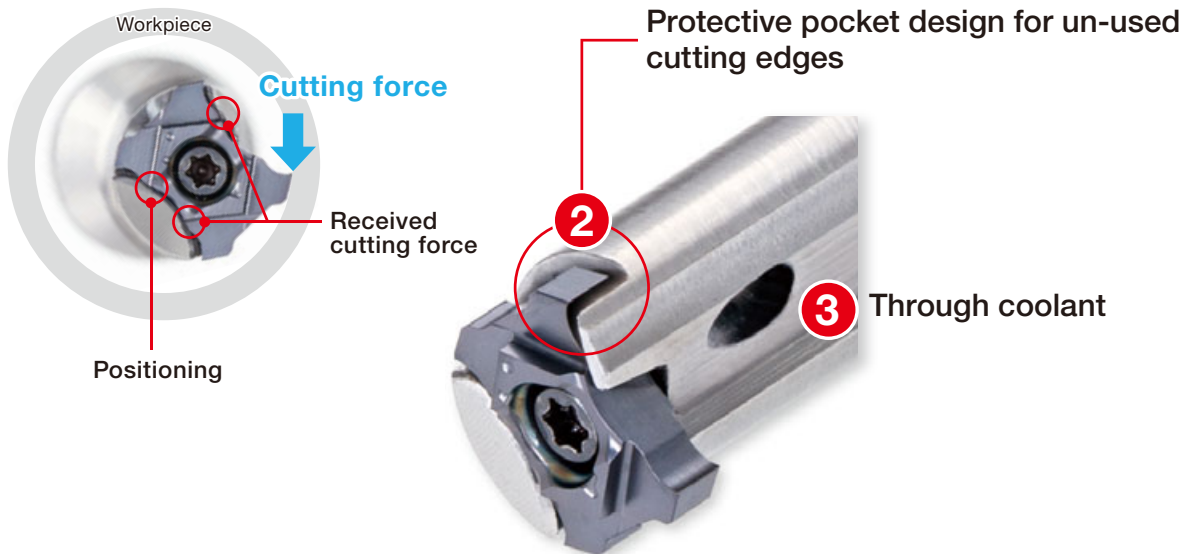

- 4** The same insert can be assembled on either left- or right-handed holder



Multi-functional grooving tool series with excellent versatility

New modular holder system enhances versatility of existing monoblock holder and TungCap (PSC) lines. High-pressure coolant system improves chip flow and tool life.

High clamping rigidity For stable tool life and accuracy

Clamping system



Stable and safe contact areas

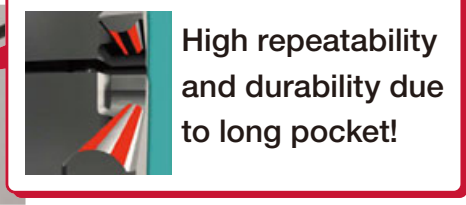
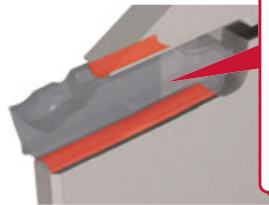

High repeatability and durability due to long pocket!

Minimizes cutting edge displacement

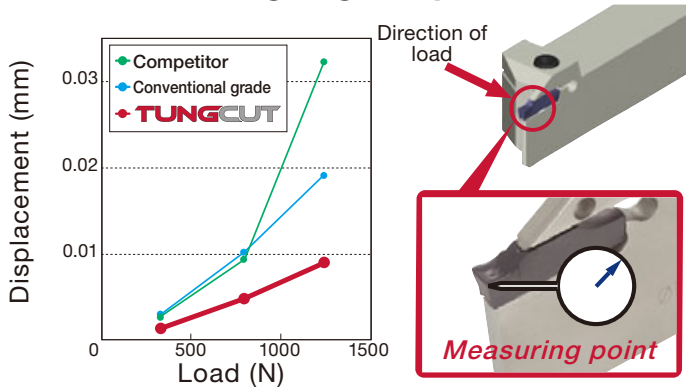

Excellent chip control at low feed rates

P Bearing steel (B1/52100/SUJ2)

First choice chipbreaker for bearing steel. Excellent chip control at low feed rates.



DGL

Workpiece material : SUJ2
Toolholder : CTER2525-3T09
Insert : DGL3-025
Cutting speed : Vc = 50, 100 m/min
Groove width : 3 mm

Cutting speed: Vc (m/min)	Feed: f (mm/rev)			
	0.03	0.05	0.07	0.1
100				
50				

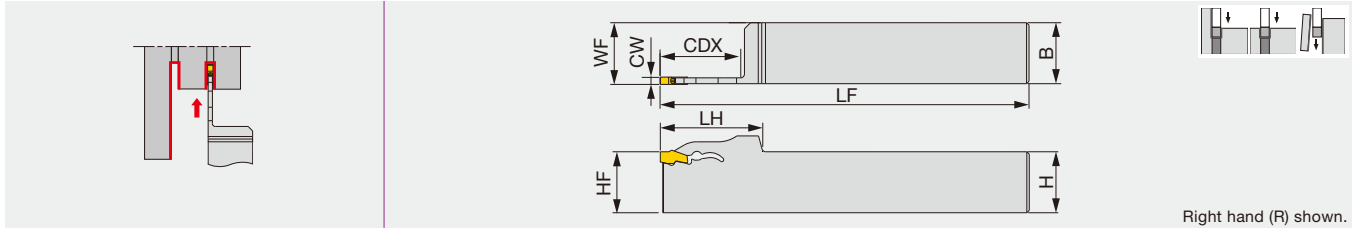

Designation	CW	CDX	Seat size	H	B	LF	LH	HF	WF
QSER/L2020-2T26	2	26	2	20	20	125	36	20	20.1
QSER/L2020-2T33	2	33	2	20	20	125	42	20	20.1
QSER/L2525-2T26	2	26	2	25	25	150	36	25	25.1
QSER/L2525-2T33	2	33	2	25	25	150	42	25	25.1
QSER/L2020-3T26	3	26	3	20	20	125	36	20	20.3
QSER/L2020-3T33	3	33	3	20	20	125	42	20	20.3
QSER/L2525-3T26	3	26	3	25	25	150	36	25	25.3
QSER/L2525-3T33	3	33	3	25	25	150	42	25	25.3
QSER/L2020-4T33	4	33	4	20	20	125	42	20	20.4
QSER/L2525-4T33	4	33	4	25	25	150	42	25	25.4
QSER/L2525-5T33	5	33	5	25	25	150	42	25	25.5

SPARE PARTS

Designation	Wrench
QSER/L...	QL-39

- External
- Internal
- Face
- Parting
- Others

CHIPBREAKER GUIDE

QGM



First choice for grooving and parting

Smooth chip evacuation
Well-designed edge with high strength
CW = 2 - 5 mm

Standard feed

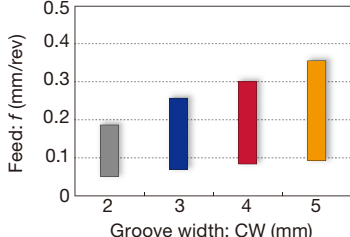

QGS



Lower cutting force and superior sharpness

Uniquely designed edge and chipbreaker
CW = 2 - 5 mm

Standard feed

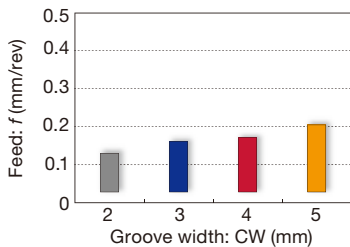

INSERTS

QGM

External deep grooving and parting

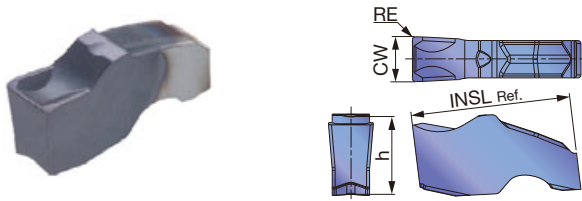

P	Steel	★									
M	Stainless	★									
K	Cast iron	★									
N	Non-ferrous										
S	Superalloys	★									
H	Hard materials										★ : First choice

Designation	Seat size	CW±0.05	RE	Coated								INSL	h
				AH7025									
QGM2-020	2	2	0.2	●								11	5.3
QGM3-020	3	3	0.2	●								11	5.3
QGM4-030	4	4	0.3	●								13	7.3
QGM5-030	5	5	0.3	●								13	7.3

● : Line up

QGS

External deep grooving and parting

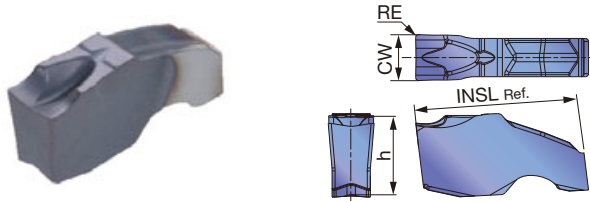

P	Steel	★									
M	Stainless	★									
K	Cast iron	★									
N	Non-ferrous										
S	Superalloys	★									
H	Hard materials										★ : First choice

Designation	Seat size	CW±0.05	RE	Coated								INSL	h
				AH7025									
QGS2-020	2	2	0.2	●								11	5.3
QGS3-020	3	3	0.2	●								11	5.3
QGS4-030	4	4	0.3	●								13	7.3
QGS5-030	5	5	0.3	●								13	7.3

● : Line up

STANDARD CUTTING CONDITIONS

ISO	Workpiece material	Hardness	Grade	Cutting speed Vc (m/min)
P	Steels C45, 34CrMo4, etc.	< 300 HB	AH7025	50 - 180
M	Stainless steel X10CrNiS18-9, etc.	< 200 HB	AH7025	50 - 120
K	Gray cast iron GG25, 250, etc.	-	AH7025	50 - 180
	Ductile cast irons GGG45, 450-10S, etc.	-	AH7025	50 - 120
S	Superalloys Inconel718, etc.	< HRC 40	AH7025	20 - 60
	Titanium alloys Ti-6Al-4V, etc.	< HRC 40	AH7025	20 - 80

Please see page F012 for feed: f (mm/rev).



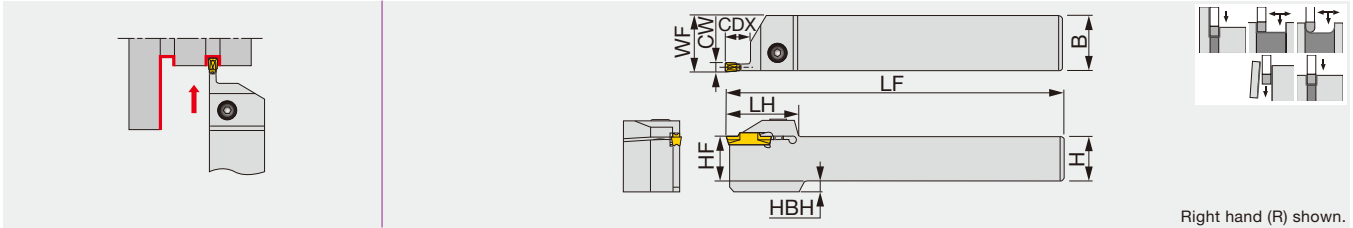

Designation	CW	Seat size	CDX	H	B	LF	LH	HF	WF ⁽¹⁾	HBH	Torque*
CTER/L1616-2T08	2	2	8	16	16	110	33	16	16.1	4	5
CTER/L2020-2T08	2	2	8	20	20	125	33	20	20.1	-	5
CTER/L2525-2T08	2	2	8	25	25	150	33	25	25.1	-	5
CTER/L1616-2T12	2	2	12	16	16	110	32	16	16.1	4	5
CTER/L2020-2T12	2	2	12	20	20	125	32	20	20.1	-	5
CTER/L2525-2T12	2	2	12	25	25	150	32	25	25.1	-	5
CTER/L1616-2T17	2	2	17	16	16	110	37	16	16.1	4	5
CTER/L2020-2T17	2	2	17	20	20	125	37	20	20.1	-	5
CTER/L2525-2T17	2	2	17	25	25	150	37	25	25.1	-	5
CTER/L2525-2T20	2	2	20	25	25	150	38.5	25	25.1	-	5
CTER/L1616-3T09	3	3	9	16	16	110	32	16	16.3	4	5
CTER/L2020-3T09	3	3	9	20	20	125	32	20	20.3	-	5
CTER/L2525-3T09	3	3	9	25	25	150	32	25	25.3	-	5
CTER/L1616-3T12	3	3	12	16	16	110	32	16	16.3	4	5
CTER/L2020-3T12	3	3	12	20	20	125	32	20	20.3	-	5
CTER/L2525-3T12	3	3	12	25	25	150	32	25	25.3	-	5
CTER/L1616-3T20	3	3	20	16	16	110	38.5	16	16.3	4	5
CTER/L2020-3T20	3	3	20	20	20	125	38.5	20	20.3	-	5
CTER/L2525-3T20	3	3	20	25	25	150	38.5	25	25.3	-	5
CTER/L2525-3T25	3	3	25	25	25	150	44.5	25	25.3	-	5
CTER/L1616-4T10	4	4	10	16	16	110	32	16	16.5	4	8.5
CTER/L2020-4T10	4	4	10	20	20	125	32	20	20.5	-	8.5
CTER/L2525-4T10	4	4	10	25	25	150	32	25	25.5	-	8.5
CTER/L2020-4T15	4	4	15	20	20	125	33	20	20.5	-	8.5
CTER/L2525-4T15	4	4	15	25	25	150	33	25	25.5	-	8.5
CTER/L1616-4T25	4	4	25	16	16	110	45	16	16.5	4	8.5
CTER/L2020-4T25	4	4	25	20	20	125	45	20	20.5	-	8.5
CTER/L2525-4T25	4	4	25	25	25	150	45	25	25.5	-	8.5
CTER/L3232-4T25	4	4	25	32	32	170	45	32	32.5	-	8.5
CTER/L2020-5T12	5	5	12	20	20	125	37	20	20.6	-	8.5
CTER/L2525-5T12	5	5	12	25	25	150	37	25	25.6	-	8.5
CTER/L2525-5T17	5	5	17	25	25	150	37	25	25.6	-	8.5
CTER/L2525-5T20	5	5	20	25	25	150	37	25	25.6	-	8.5
CTER/L2525-5T32	5	5	32	25	25	150	56	25	25.6	-	8.5
CTER/L3232-5T32	5	5	32	32	32	170	56	32	32.6	-	8.5
CTER/L2020-6T12	6	6	12	20	20	125	37	20	20.6	-	12
CTER/L2525-6T12	6	6	12	25	25	150	37	25	25.6	7	12
CTER/L2525-6T16	6	6	16	25	25	150	39	25	25.6	7	12
CTER/L2525-6T20	6	6	20	25	25	150	41	25	25.6	7	12
CTER/L2525-6T25	6	6	25	25	25	150	47	25	25.6	7	12
CTER/L2525-6T32	6	6	32	25	25	150	56	25	25.6	7	12
CTER/L3232-6T32	6	6	32	32	32	170	56	32	32.6	-	12
CTER/L2525-8T16	8	8	16	25	25	150	47	25	26.1	7	12
CTER/L2525-8T25	8	8	25	25	25	150	47	25	26.1	7	12
CTER/L3232-8T25	8	8	25	32	32	170	47	32	33.1	-	12
CTER/L3232-8T32	8	8	32	32	32	170	56	32	33.1	-	12
CTER/L2525-8T36	8	8	36	25	25	150	60	25	26.1	7	12
CTER/L3232-8T36	8	8	36	32	32	170	60	32	33.1	-	12

When groove depth is larger than (insert length - 1.5 mm), please use 1-cornered insert.

(1) "WF" value is calculated with groove width "CW" shown in the table.

Torque*: Recommended clamping torque (N·m)

SPARE PARTS



Designation	Clamping screw	Wrench
CTER/L1616-2T08	CM5X0.8X16-A	P-4
CTER/L2020-2T08	CM5X0.8X20-A	P-4
CTER/L2525-2T08	CM5X0.8X25-A	P-4
CTER/L1616-2T12	CM5X0.8X16-A	P-4
CTER/L2020-2T12	CM5X0.8X20-A	P-4
CTER/L2525-2T12	CM5X0.8X25-A	P-4
CTER/L1616-2T17	CM5X0.8X16-A	P-4
CTER/L2020-2T17	CM5X0.8X20-A	P-4
CTER/L2525-2T17	CM5X0.8X25-A	P-4
CTER/L2525-2T20	CM5X0.8X25-A	P-4
CTER/L1616-3T09	CM5X0.8X16-A	P-4
CTER/L2020-3T09	CM5X0.8X20-A	P-4
CTER/L2525-3T09	CM5X0.8X25-A	P-4
CTER/L1616-3T12	CM5X0.8X16-A	P-4
CTER/L2020-3T12	CM5X0.8X20-A	P-4
CTER/L2525-3T12	CM5X0.8X25-A	P-4
CTER/L1616-3T20	CM5X0.8X16-A	P-4
CTER/L2020-3T20	CM5X0.8X20-A	P-4
CTER/L2525-3T20	CM5X0.8X25-A	P-4
CTER/L2525-3T25	CM5X0.8X25-A	P-4
CTER/L1616-4T10	CM6X1X16-A	P-5
CTER/L2020-4T10	CM6X1X20-A	P-5
CTER/L2525-4T10	CM6X1X25-A	P-5
CTER/L2020-4T15	CM6X1X20-A	P-5
CTER/L2525-4T15	CM6X1X25-A	P-5
CTER/L1616-4T25	CM6X1X16-A	P-5
CTER/L2020-4T25	CM6X1X20-A	P-5
CTER/L2525-4T25	CM6X1X25-A	P-5
CTER/L3232-4T25	CM6X1X25-A	P-5
CTER/L2020-5T12	CM6X1X20-A	P-5
CTER/L2525-5T12	CM6X1X25-A	P-5
CTER/L2525-5T17	CM6X1X25-A	P-5
CTER/L2525-5T20	CM6X1X25-A	P-5
CTER/L2525-5T32	CM6X1X25-A	P-5
CTER/L3232-5T32	CM6X1X25-A	P-5
CTER/L2020-6T12	CM8X1.25X20-A	P-6
CTER/L2525-6T12	CM8X1.25X25-A	P-6
CTER/L2525-6T16	CM8X1.25X25-A	P-6
CTER/L2525-6T20	CM8X1.25X25-A	P-6
CTER/L2525-6T25	CM8X1.25X25-A	P-6
CTER/L2525-6T32	CM8X1.25X25-A	P-6
CTER/L3232-6T32	CM8X1.25X25-A	P-6
CTER/L2525-8T16	CM8X1.25X25-A	P-6
CTER/L2525-8T25	CM8X1.25X25-A	P-6
CTER/L3232-8T25	CM8X1.25X25-A	P-6
CTER/L3232-8T32	CM8X1.25X25-A	P-6
CTER/L2525-8T36	CM8X1.25X25-A	P-6
CTER/L3232-8T36	CM8X1.25X25-A	P-6

Grade

Insert

Ext. Toolholder

Int. Toolholder

Threading

Grooving

Miniature tool

Milling cutter

Endmill

Drilling tool

Tooling System

User's Guide

Index



Reference pages: Inserts → **F028 - F042**, Standard cutting conditions → **F043**

External grooving and parting toolholder, with high pressure coolant capability

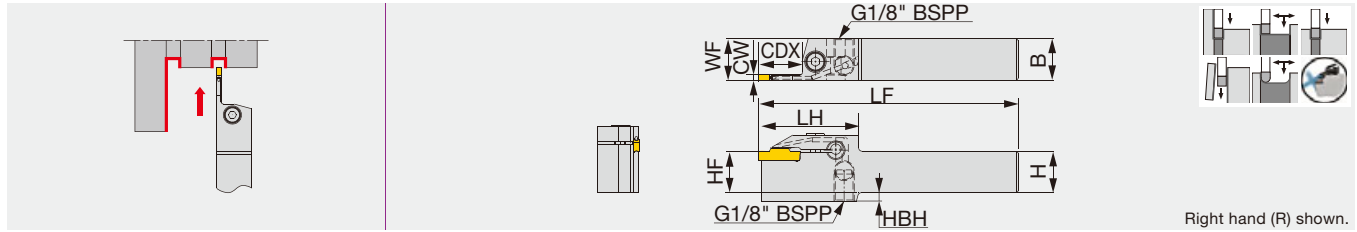

Right hand (R) shown.

Designation	CW	Seat size	CDX	H	B	LF	LH	HF	WF ⁽¹⁾	HBH	Torque*
CTER/L2020-2T17-CHP	2	2	17	20	20	125	45	20	20.1	4	5.5
CTER/L2525-2T17-CHP	2	2	17	25	25	150	45	25	25.1	-	5.5
CTER/L2020-3T20-CHP	3	3	20	20	20	125	48	20	20.3	4	5.5
CTER/L2525-3T20-CHP	3	3	20	25	25	150	48	25	25.3	-	5.5
CTER/L2525-3T25-CHP	3	3	25	25	25	150	51	25	25.3	-	5.5
CTER/L2525-4T25-CHP	4	4	25	25	25	150	55	25	25.5	-	8
CTER/L2525-5T20-CHP	5	5	20	25	25	150	49	25	25.58	-	8
CTER/L2525-6T20-CHP	6	6	20	25	25	150	52	25	25.58	7	12

When groove depth is larger than (insert length - 1.5 mm), please use 1-cornered insert.
 (1) "WF" value is calculated with groove width "CW" shown in the table.
 Torque*: Recommended clamping torque (N·m)

SPARE PARTS



Designation	Clamping screw	Wrench
CTER/L2020-2T17-CHP	CM5x0.8x20-A	P-4
CTER/L2525-2T17-CHP	CM5x0.8x25-A	P-4
CTER/L2020-3T20-CHP	CM5x0.8x20-A	P-4
CTER/L2525-3T20-CHP	CM5x0.8x25-A	P-4
CTER/L2525-3T25-CHP	CM5x0.8x25-A	P-4
CTER/L2525-4T25-CHP	CM6x1x16-A	P-5
CTER/L2525-5T20-CHP	CM6x1x16-A	P-5
CTER/L2525-6T20-CHP	CM8x1.25x20-A	P-6

Reference pages: Inserts → **F028 - F042**, Standard cutting conditions → **F043**
 Parts for coolant hose → **F266**

CTEFR/L

External face grooving and turning toolholder

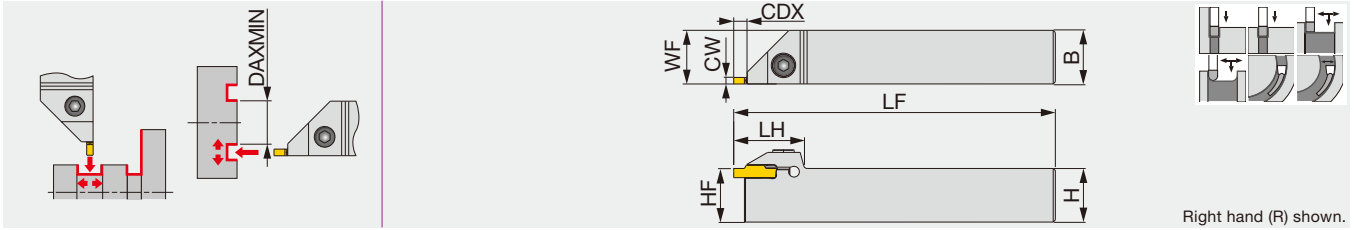

Designation	CW	Seat size	CDX	H	B	LF	LH	HF	WF ⁽¹⁾	Torque*
CTEFR/L2020-4T04	4	2, 3, 4	4.8	20	20	125	33	20	20.5	8.5
CTEFR/L2525-4T04	4	2, 3, 4	4.8	25	25	150	33	25	25.5	8.5
CTEFR/L2020-6T04	6	5, 6	4.8	20	20	125	37	20	20.6	8.5
CTEFR/L2525-6T04	6	5, 6	4.8	25	25	150	37	25	25.6	8.5

Use the right-hand insert for the right-hand holder with DTF insert.
 (1) "WF" value is calculated with groove width "CW" shown in the table.
 Torque*: Recommended clamping torque (N·m)

SPARE PARTS

Designation	Clamping screw	Wrench
CTEFR/L2020-4T04	CM6X1X20-A	P-5
CTEFR/L2525-4T04	CM6X1X25-A	P-5
CTEFR/L2020-6T04	CM6X1X20-A	P-5
CTEFR/L2525-6T04	CM6X1X25-A	P-5

Insert	Groove width CW	Face grooving Min. machining dia. DAXMIN
DGM / DGS / SGN / DGL	2	295
DGM / DGS / SGN / DGL	3	92
DGM / DGS / SGN / DGL	4	37
DGM / DGS / SGN / DGL	5	60
DGM / DGS / DGL	6	57
DTX / DTM / DTR	2	295
DTE / DGG / DTM	3	62
DTE / DGG / DTM	4	42
DTE / DGG / DTM	5	64
DTE / DGG / DTM	6	61

Insert	Groove width CW	Face grooving Min. machining dia. DAXMIN
DTR	3	44
DTR	4	32
DTR	5	48
DTR	6	48
DTX	3	22
DTX	4	20
DTX	5	20
DTX	6	23
DTF	3	20
DTF	4	20

External grooving and parting toolholder, for Swiss lathes

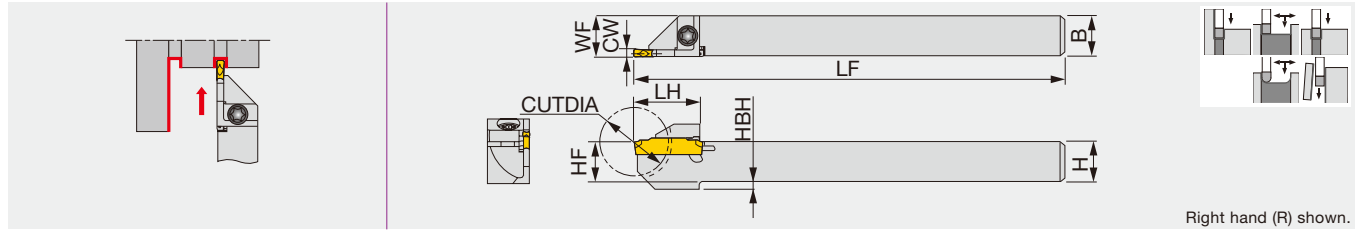

Designation	CW	Seat size	CUTDIA	H	B	LF	LH	HF	WF ⁽¹⁾	HBH	Torque*
JCTER/L1010X1.4T10	1.4	1	20	10	10	120	18	10	10.2	-	3
JCTER/L1212F1.4T12	1.4	1	24	12	12	85	19.5	12	12.2	-	3
JCTER/L1212X1.4T12	1.4	1	24	12	12	120	19.5	12	12.2	-	3
JCTER/L1414-1.4T12	1.4	1	24	14	14	125	19.5	14	14.2	-	3
JCTER/L1616X1.4T16	1.4	1	32	16	16	120	24	16	16.2	-	3
JCTER/L1010X2T10	2	2	20	10	10	120	19	10	10.1	2	3
JCTER/L1212F2T12	2	2	24	12	12	85	19	12	12.1	2	3
JCTER/L1212X2T12	2	2	24	12	12	120	19	12	12.1	2	3
JCTER/L1414-2T12	2	2	24	14	14	125	19	14	14.1	-	3
JCTER/L1616X2T16	2	2	32	16	16	120	24	16	16.1	-	3
JCTER/L1212F3T12	3	3	24	12	12	85	19	12	12.3	2	3
JCTER/L1212X3T12	3	3	24	12	12	120	19	12	12.3	2	3
JCTER/L1616X3T16	3	3	32	16	16	120	24	16	16.3	-	3
JCTER/L2020H3T16	3	3	32	20	20	100	24	20	20.3	-	3

(1) "WF" value is calculated with groove width "CW" shown in the table.
Torque*: Recommended clamping torque (N·m)

JCTER/L2012

External grooving and parting toolholder, for Swiss lathes, with 20 mm shank height

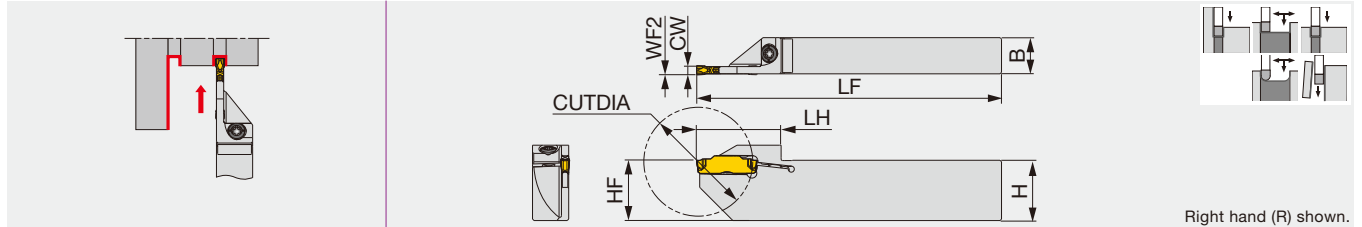

Designation	CW	Seat size	CUTDIA	H	B	LF	LH	HF	WF2 ⁽¹⁾	Torque*
JCTER/L2012H2T18	2	2	36	20	12	100	25	20	0.1	3
JCTER/L2012H3T21	3	3	42	20	12	100	28	20	0.3	3

(1) "WF2" value is calculated with groove width "CW" shown in the table.
Torque*: Recommended clamping torque (N·m)

SPARE PARTS

Designation	Clamping screw	Wrench
JCTER/L...	CSHB-4-A	T-15F

Reference pages: Inserts → **F028 - F042**, Standard cutting conditions → **F043**

JCTER/L-CHP

Direct connection

External grooving and parting toolholder, with high pressure coolant capability

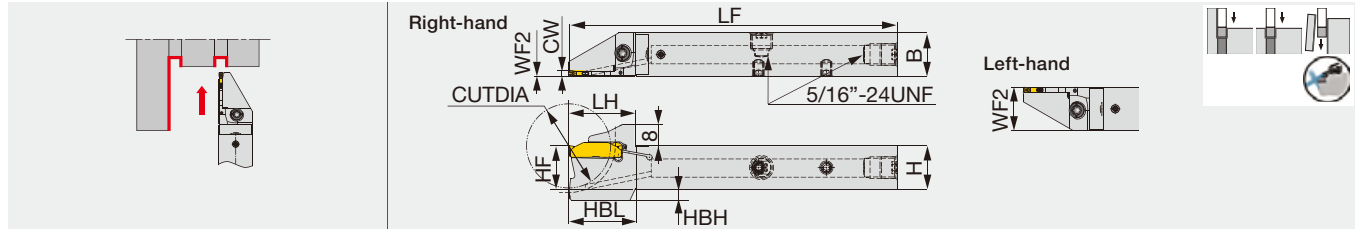

Designation	CW	Seat size	CUTDIA	H	B	LF	LH	HF	WF2 ⁽¹⁾	HBH	HBL	Torque*
JCTER/L1212X2T12-CHP	2	2	25	12	12	120	24.7	12	0/12	5	24.7	3
JCTER/L1616X2T12-CHP	2	2	25	16	16	120	24.7	16	0/16	1	24.5	3
JCTER/L1616X2T16-CHP	2	2	32	16	16	120	24.7	16	0/16	4	24.7	3
JCTER/L2020X2T16-CHP	2	2	32	20	20	120	24.7	20	0/20	-	-	3

(1) "WF2" value is calculated with groove width "CW" shown in the table. The first value before "/" indicates the WF2 for the right-hand holder and the second value after "/" for the left-hand holder.

Torque*: Recommended clamping torque (N·m)

SPARE PARTS

Designation	Clamping screw	Wrench 1	Coolant plug	Wrench 2	DirectJet plug	Wrench 3
JCTER/L...	CSHB-4-A	T-15F	SR5/16UNFTL360	P-4	SSHM4-6-TB	P-2

JTTER/L

External grooving and parting toolholder, for Swiss lathes

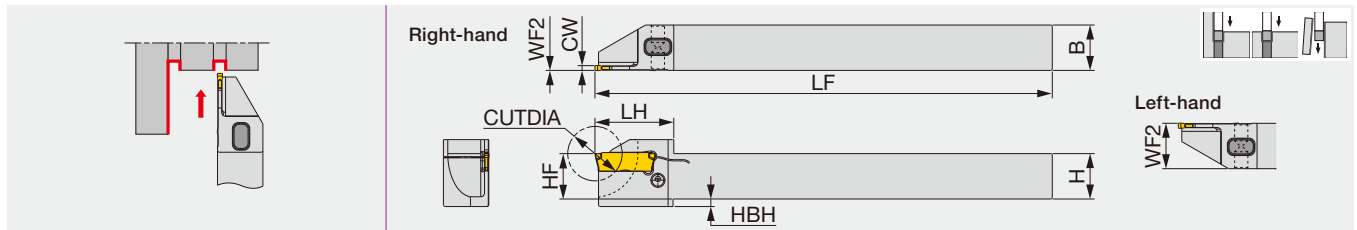

Designation	CW	Seat size	CUTDIA	H	B	LF	LH	HF	WF2 ⁽¹⁾	HBH	Torque*
JTTER/L1010H1.2D12	1.2	0.9	12	10	10	100	17	10	0/10	-	1.5
JTTER/L1212F1.2D16	1.2	0.9	16	12	12	85	19	12	0/12	-	1.5
JTTER/L1212X1.2D16	1.2	0.9	16	12	12	120	19	12	0/12	-	1.5
JTTER/L1212X1.2D20	1.2	0.9	20	12	12	120	21	12	0/12	2	1.5
JTTER/L1616X1.2D20	1.2	0.9	20	16	16	120	21	16	0/16	-	2

(1) "WF2" value is calculated with groove width "CW" shown in the table. The first value before "/" indicates the WF2 for the right-hand holder and the second value after "/" for the left-hand holder.

Torque*: Recommended clamping torque (N·m)

SPARE PARTS

Designation	Clamping screw	Clamping pin	Wrench
JTTER/L1010...	SSM3.5x0.35	PIN-SL-TC	P-2F
JTTER/L1212...	SSM3.5x0.35	PIN-SL-TC	P-2F
JTTER/L1616...	SRM5-24145-RL	PIN-32121	P-2.5F

Reference pages: Inserts → **F028 - F042**, Standard cutting conditions → **F043**
Parts for coolant hose → **F266**



External grooving and parting toolholder, for Swiss lathes (for sub spindle)

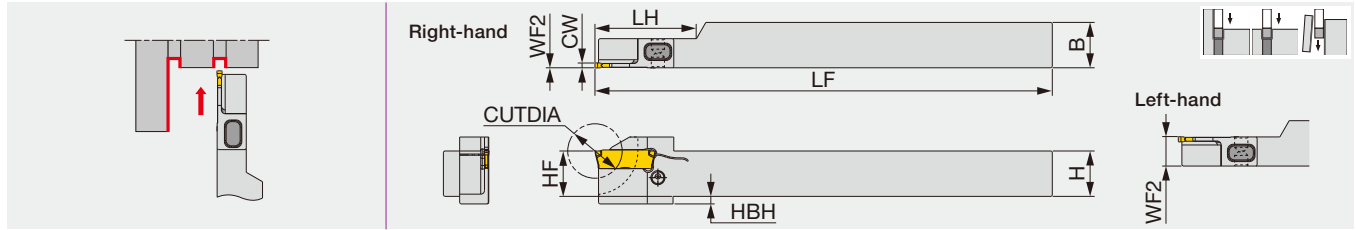

Designation	CW	Seat size	CUTDIA	H	B	LF	LH	HF	WF2 ⁽¹⁾	HBH	Torque*
JTTER/L1010H1.2D12-S	1.2	0.9	12	10	10	100	22.8	10	0/7.7	-	1.5
JTTER1212F1.2D16-S ⁽²⁾	1.2	0.9	16	12	12	85	22.8	12	0	-	1.5
JTTER/L1212X1.2D16-S	1.2	0.9	16	12	12	120	26.8	12	0/7.7	-	1.5
JTTER/L1212X1.2D20-S	1.2	0.9	20	12	12	120	26.8	12	0/7.7	2	1.5
JTTER/L1616X1.2D20-S	1.2	0.9	20	16	16	120	26.8	16	0/7.7	-	1.5

(1) "WF2" value is calculated with groove width "CW" shown in the table. The first value before "/" indicates the WF2 for the right-hand holder and the second value after "/" for the left-hand holder.

(2) No clamping screw from the insert side.
Torque*: Recommended clamping torque (N·m)

SPARE PARTS

Designation	Clamping screw	Clamping pin	Wrench
JTTER/L*-S	SSM3.5x0.35	PIN-SL-TC	P-2F

CGER/L

External deep grooving and parting toolholder, for Swiss lathes

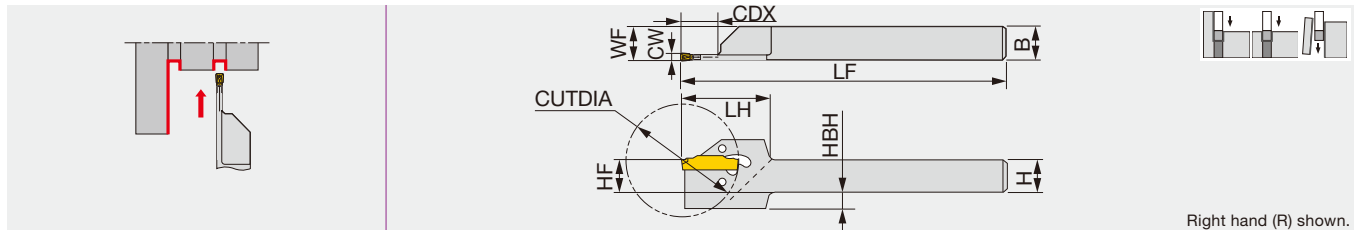

Designation	CW	Seat size	CUTDIA ⁽¹⁾	CDX	H	B	LF	LH	HF	WF ⁽²⁾	HBH
CGER/L2020-1.4T14	1.4	1	29/29	9.7	20	20	125	31	20	20.2	-
CGER/L1212-2T17	2	2	35/35	11.8	12	12	150	31	12	12.1	6
CGER/L1616-2T17	2	2	35/35	11.8	16	16	150	31	16	16.1	2
CGER/L2020-2T17	2	2	35/35	9.8	20	20	125	31	20	20.1	-
CGER/L1212-3T19	3	3	38/40	12	12	12	150	31	12	12.3	6
CGER/L1616-3T19	3	3	38/45	14.9	16	16	150	31	16	16.3	2
CGER/L2020-3T19	3	3	38/45	13.2	20	20	125	31	20	20.3	-
CGER/L2020-4T19	4	4	38/55	20.3	20	20	125	33	20	20.4	-

Wrench (CRW**) is not included. Please order it separately. Insert is clamped by the elastic deformation of the upper jaw.

(1) DG*/SG* maximum parting diameter will depend on the insert.

(2) "WF" value is calculated with groove width "CW" shown in the table.

SPARE PARTS

Designation	Wrench (Option)
CGER/L2020-1.4T14	CRW23
CGER/L****-2T17 - 4T19	CRW33

Reference pages: Inserts → **F028 - F042**, Standard cutting conditions → **F043**

CAER/L-CHP

External grooving and parting adapter, with high pressure coolant capability

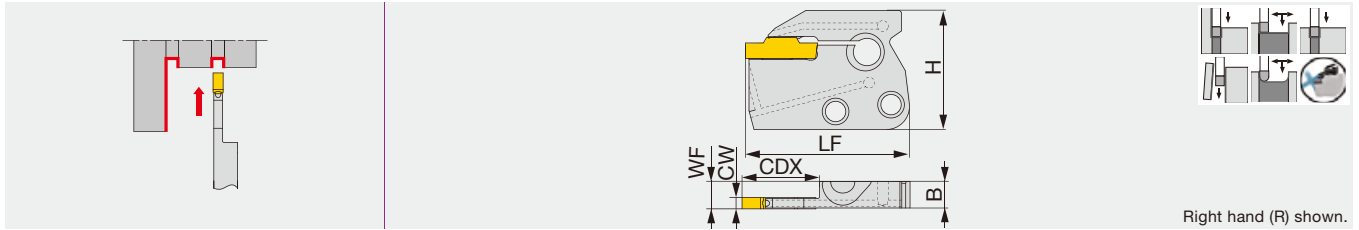

Designation	CW	Seat size	CDX	H	B	LF	WF ⁽¹⁾
CAER/L-2T16-CHP	2	2	16	33	7.2	41.5	7.3
CAER/L-2T20-CHP	2	2	20	33	7.2	45.5	7.3
CAER/L-3T16-CHP	3	3	16	33	7.2	41.5	7.4
CAER/L-3T20-CHP	3	3	20	33	7.2	45.5	7.5
CAER/L-4T16-CHP	4	4	16	33	7.2	41.5	7.7
CAER/L-4T20-CHP	4	4	20	33	7.2	45.5	7.7
CAER/L-5T20-CHP	5	5	20	33	7.2	46.3	7.8
CAER/L-6T20-CHP	6	6	20	33	7.2	46.3	7.8
CAER/L-8T25-CHP	8	8	25	33	7.2	51.1	8.3

When groove depth is larger than (insert length - 1.5 mm), please use 1-cornered insert.
 (1) WF is calculated with the groove width (CW) in the above table.

CAER/L-MD

External grooving and parting adapter

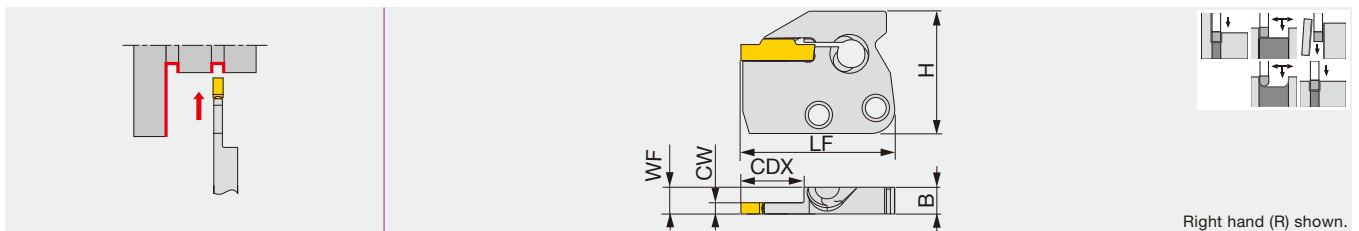

Designation	CW	Seat size	CDX	H	B	LF	WF ⁽¹⁾
CAER/L-2T16-MD	2	2	16	33	7.2	41.5	7.3
CAER/L-3T16-MD	3	3	16	33	7.2	41.5	7.4
CAER/L-4T16-MD	4	4	16	33	7.2	41.5	7.7
CAER/L-5T20-MD	5	5	20	33	7.2	46.3	7.8
CAER/L-6T20-MD	6	6	20	33	7.2	46.3	7.8
CAER/L-8T25-MD	8	8	25	33	7.2	51.1	8.3

(1) WF is calculated with the groove width (CW) in the above table.

CAEFR/L-CHP

Face and external grooving adapter, with high pressure coolant capability

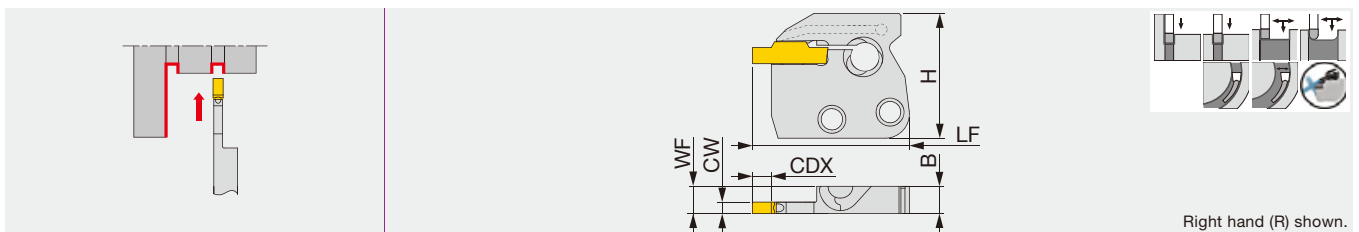

Designation	CW	Seat size	CDX	H	B	LF	WF ⁽¹⁾
CAEFR/L-4T04-CHP	4	2,3,4	4.8	33	7.2	41.5	7.7
CAEFR/L-6T04-CHP	6	5,6	4.8	33	7.2	46.3	7.8

Use the right-hand insert for the right-hand holder with DTF insert.
 (1) "WF" value is calculated with groove width "CW" shown in the table.

Reference pages: Inserts → **F028 - F042**, Shanks and toolholders → **F022 - F024**
 Standard cutting conditions → **F043**, Technical Reference → **L053**

Shank for adapter, with high pressure coolant capability

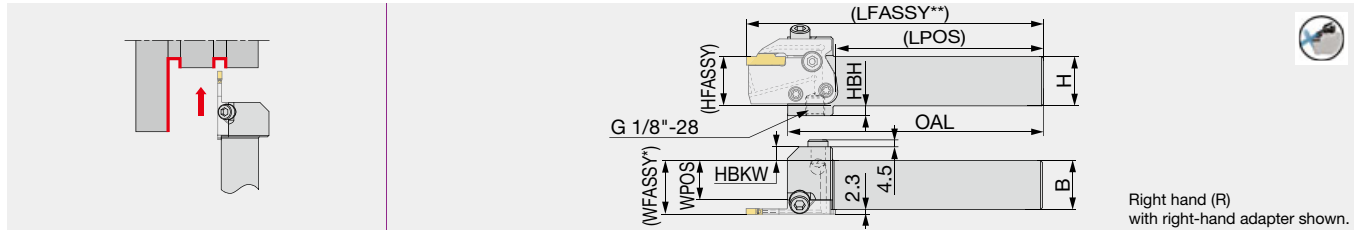

Right hand (R)
with right-hand adapter shown.

Designation	H	B	OAL	LPOS	WPOS	HBKW	HFASSY	HBH	Adapter (Option)	Torque*
CHSR/L2020-CHP	20	20	130	105.5	15.1	12	20	10	CAE*R/L**-CHP, -MD	6.5
CHSR/L2525-CHP	25	25	130	105.5	20.1	7	25	5	CAE*R/L**-CHP, -MD	6.5

WFASSY* : Shank (WPOS) + adapter (WF)

LFASSY** : Shank (LPOS) + adapter (LF)

Depend on the adapter type, the value of LFASSY or WFASSY may change.

Torque*: Recommended clamping torque (N·m)

Applicable for 30 MPa coolant

Please see page L053 for instructions on installing and removing the adapter or the insert.

External

Internal

Face

Parting

Others

CHSR/L-CHP-MC

Direct connection

Shank for adapter, with high pressure coolant capability

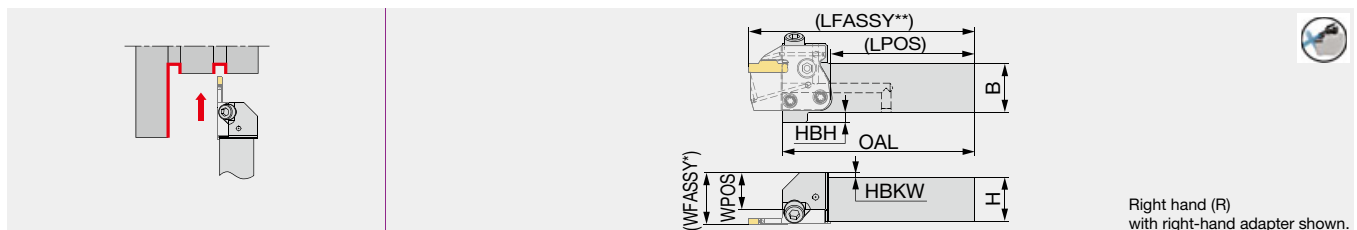

Right hand (R)
with right-hand adapter shown.

Designation	H	B	OAL	LPOS	WPOS	HBKW	HBH	Adapter (Option)	Torque*
CHSR/L2020-CHP-MC	20	20	98	73.5	14	6	10	CAE*R/L**-CHP, -MD	6.5
CHSR/L2525-CHP-MC	25	25	98	73.5	19	-	5	CAE*R/L**-CHP, -MD	6.5

WFASSY* : Shank (WPOS) + adapter (WF)

LFASSY** : Shank (LPOS) + adapter (LF)

Depend on the adapter type, the value of LFASSY or WFASSY may change.

Torque*: Recommended clamping torque (N·m)

Applicable for 30 MPa coolant

Please see page L053 for instructions on installing and removing the adapter or the insert.

SPARE PARTS

Designation	Clamping screw 1	Wrench 1	Clamping screw 2	Clamping screw 3	Wrench 2	O-ring	Plug
CHSR/L**-CHP	SR M5-04451	T-20/5	SR M6X12DIN6912	SR M6X20-XT	HW5.0	OR 5X1N	PLUGG1/8ISO1179
CHSR/L**-CHP-MC	SR M5-04451	T-20/5	SR M6X12DIN6912	SR M6X20-XT	HW5.0	OR 5X1N	-

Recommended clamping torque (N·m)

Clamping screw	Torque (N·m)
SR M5-04451	2.5
SR M6X12DIN6912	6.5
SR M6X20-XT	6.5

Combination of adapter and shank

Shank	External grooving adapter		Face grooving adapter		External and face grooving adapter	
	CAE**R/L**-CHP, -MD	CAEL**R/L**-CHP, -MD	CAFR**R/L**-CHP	CAFL**R/L**-CHP	CAEFR**R/L**-CHP	CAEFL**R/L**-CHP
CHSR**R/L**-CHP (-MC)	●			●	●	
CHSL**R/L**-CHP (-MC)		●	●			●

● : Corresponding

Reference pages: Inserts → F028 - F042, Adapters → F021, Standard cutting conditions → F043
Parts for coolant hose → F266, Technical Reference → L053

CHFVR/L-CHP

Tube connection

Shank for perpendicularly-mounted adapter, with high pressure coolant capability

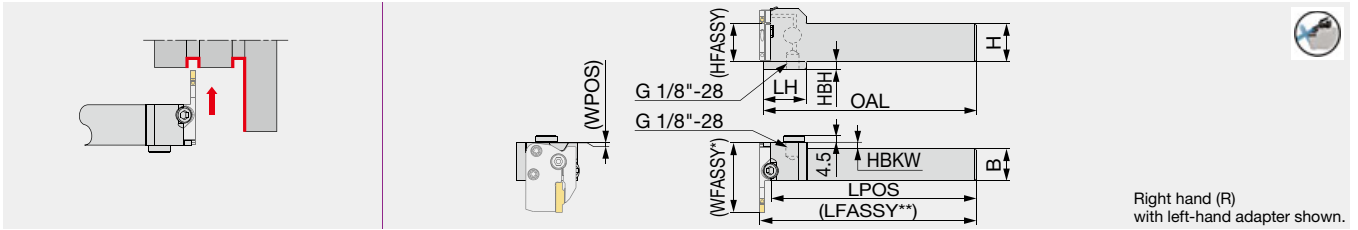

Designation	H	B	OAL	LH	LPOS	WPOS	HBKW	HFASSY	HBH	Adapter (Option)	Torque*
CHFVR/L2020-CHP	20	20	140	28	135.1	0.5	5	20	10	CAE*L/R**-CHP, -MD	6.5
CHFVR/L2525-CHP	25	25	140	28	135.1	0.5	0	25	5	CAE*L/R**-CHP, -MD	6.5

WFASSY* : Shank (WPOS) + adapter (LF)

LFASSY** : Shank (LPOS) + adapter (WF)

Depend on the adapter type, the value of LFASSY or WFASSY may change.

Torque*: Recommended clamping torque (N·m)

Applicable for 30 MPa coolant

Please see page L053 for instructions on installing and removing the adapter or the insert.

SPARE PARTS

Designation	Clamping screw 1	Wrench 1	Clamping screw 2	Clamping screw 3	Wrench 2	O-ring	Plug
CHFVR/L...	SR M5-04451	T-20/5	SR M6X12DIN6912	SR M6X20-XT	HW5.0	OR 5X1N	PLUGG1/8ISO1179

Recommended clamping torque (N·m)

Clamping screw	Torque (N·m)
SR M5-04451	2.5
SR M6X12DIN6912	6.5
SR M6X20-XT	6.5

Combination of adapter and shank

Shank	External grooving adapter		Face grooving adapter		External and face grooving adapter	
	CAER**-CHP, -MD	CAEL**-CHP, -MD	CAFR**-CHP	CAFL**-CHP	CAEFR**-CHP	CAEFL**-CHP
CHFVR**-CHP		●	●			●
CHFVL**-CHP	●			●	●	

● : Corresponding

Reference pages: Inserts → F028 - F042, Adapters → F021, Standard cutting conditions → F043
Parts for coolant hose → F266, Technical Reference → L053

Grade
Insert
Toolholder
Int. Toolholder
Threading
Grooving
Miniature tool
Milling cutter
Endmill
Drilling tool
Tooling System
User's Guide
Index

A
B
C
D
E
F
G
H
I
J
K
L
M

Toolholder with TungCap connection, for adapter, with high pressure coolant capability

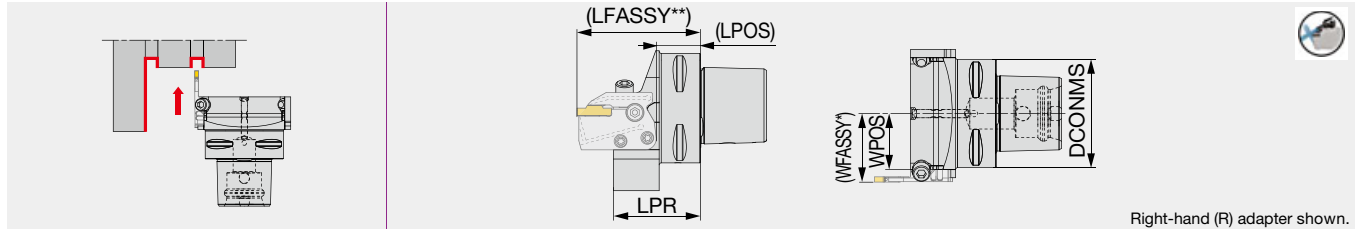

Right-hand (R) adapter shown.

Designation	DCONMS	LPR	LPOS	WPOS	Adapter (Option)	Torque*
C3CHSN19045-CHP	32	45	17.5	18.5	CAE*R/L**-CHP, -MD	6.5
C4CHSN21047-CHP	40	46.5	21.5	21	CAE*R/L**-CHP, -MD	6.5
C5CHSN26047-CHP	50	47	22.5	26	CAE*R/L**-CHP, -MD	6.5
C6CHSN33050-CHP	63	50	24.5	32.5	CAE*R/L**-CHP, -MD	6.5

WFASSY* : Toolholder (WPOS) + adapter (WF)
 LFASSY** : Toolholder (LPOS) + adapter (LF)
 Depend on the adapter type, the value of LFASSY or WFASSY may change.
 Torque*: Recommended clamping torque (N·m)
 Applicable for 30 MPa coolant
 Please see page L053 for instructions on installing and removing the adapter or the insert.



C*CHFVN-CHP

Toolholder with TungCap connection, for perpendicularly-mounted adapter, with high pressure coolant capability

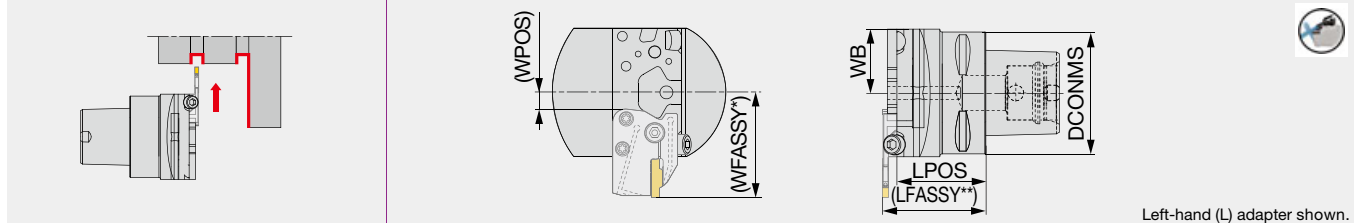

Left-hand (L) adapter shown.

Designation	DCONMS	LPOS	WB	WPOS	Adapter (Option)	Torque*
C3CHFVN26040-CHP	32	40	26	1.5	CAE*R/L**-CHP, -MD	6.5
C4CHFVN26046-CHP	40	46	26	1.5	CAE*R/L**-CHP, -MD	6.5
C5CHFVN26046-CHP	50	46	26	1.5	CAE*R/L**-CHP, -MD	6.5
C6CHFVN33046-CHP	63	46	33	8.5	CAE*R/L**-CHP, -MD	6.5

WFASSY* : Toolholder (WPOS) + adapter (LF)
 LFASSY** : Toolholder (LPOS) + adapter (WF)
 Depend on the adapter type, the value of LFASSY or WFASSY may change.
 Torque*: Recommended clamping torque (N·m)
 Applicable for 30 MPa coolant
 Please see page L053 for instructions on installing and removing the adapter or the insert.

SPARE PARTS



Designation	Clamping screw 1	Wrench 1	Clamping screw 2	Clamping screw 3	Wrench 2	O-ring
C*CH**N**-CHP	SR M5-04451	T-20/5	SR M6X12DIN6912	SR M6X20-XT	HW5.0	OR 5X1N

Recommended clamping torque (N·m)

Clamping screw	Torque (N·m)
SR M5-04451	2.5
SR M6X12DIN6912	6.5
SR M6X20-XT	6.5

CAER/L

External grooving, parting and turning adapter

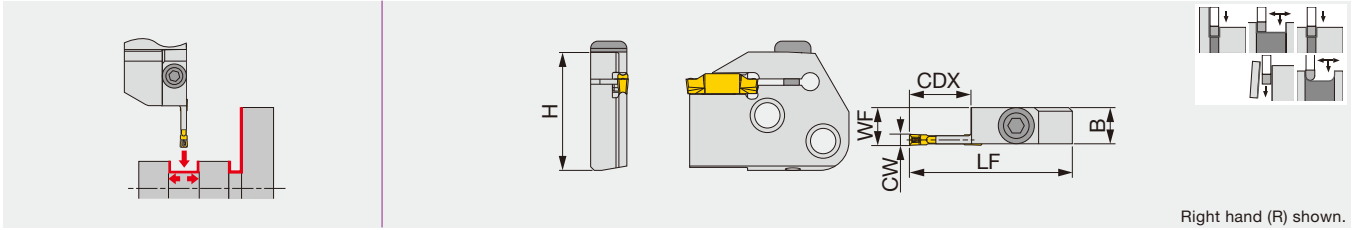

Designation	CW	Seat size	CDX	H	B	LF	WF	Torque*
CAER/L-3T16	3	3	16	32.7	10	45	10.4	5
CAER/L-4T16	4	4	16	32.7	10	45	10.5	5
CAER/L-5T20	5	5	20	32.7	10	49	10.5	5
CAER/L-6T20	6	6	20	32.7	10	49	10.5	5

Torque*: Recommended clamping torque (N·m)
 Not compatible with TungModularSystem
 When groove depth is larger than insert length - 1.5 mm, please use 1-cornered insert.

SPARE PARTS

Designation	Clamping screw	Wrench
CAER/L...	BHM6-20-A	P-4

Grade

Insert

Ext. Toolholder

Int. Toolholder

Threading

Grooving

Miniature tool

Milling cutter

Endmill

Drilling tool

Tooling System

User's Guide

Index



Reference pages: Inserts → **F028 - F042**, Shanks and toolholders → **F026, F027**
 Standard cutting conditions → **F043**

Shank for adapter

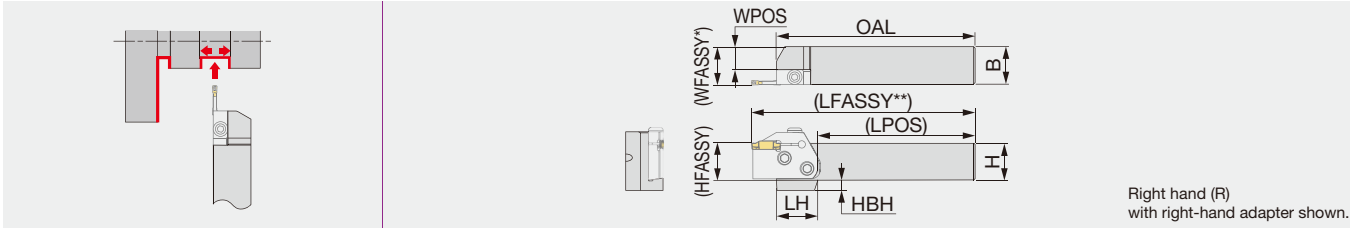

Right hand (R)
with right-hand adapter shown.

Designation	H	B	OAL	LPOS	LH	WPOS	HFASSY	HBH	Adapter (Option)
CHSR/L2020	20	20	133	105	35	10	20	12	CAER/L...
CHSR/L2525	25	25	133	105	28	15	25	7	CAER/L...
CHSR/L3232	32	32	153	125	-	22	32	-	CAER/L...

WFASSY* : Shank (WPOS) + adapter (WF)
 LFASSY** : Shank (LPOS) + adapter (LF)
 Depend on the adapter type, the value of LFASSY or WFASSY may change.
 Not compatible with TungModularSystem



CHFVR/L

Shank for adapter, perpendicularly mounted

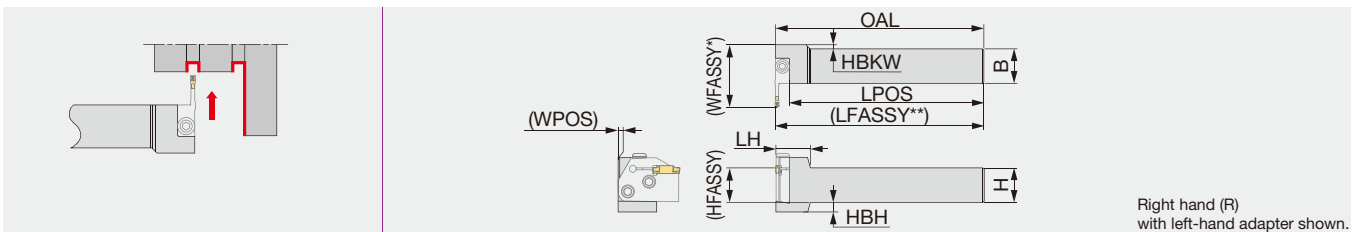

Right hand (R)
with left-hand adapter shown.

Designation	H	B	OAL	LPOS	LH	WPOS	HBKW	HFASSY	HBH	Adapter (Option)
CHFVR/L2020	20	20	150	140	25	0	8	20	12	CAEL/R...
CHFVR/L2525	25	25	150	140	25	0	3	25	7	CAEL/R...
CHFVR/L3232	32	32	170	160	25	4	-	32	-	CAEL/R...

WFASSY* : Shank (WPOS) + adapter (LF)
 LFASSY** : Shank (LPOS) + adapter (WF)
 Depend on the adapter type, the value of LFASSY or WFASSY may change.
 Not compatible with TungModularSystem

SPARE PARTS



Designation	Clamping screw	Wrench
CH**R/L...	CSHB-6-A	P-4

Combination of adapter and shank

Shank	External grooving adapter		Face grooving adapter	
	CAER...	CAEL...	CAFR...	CAFL...
CHSR...	●			●
CHSL...		●	●	
CHFVR...		●	●	
CHFVL...	●			●

● : Corresponding

C-CHSR/L

Toolholder with TungCap connection for adapter

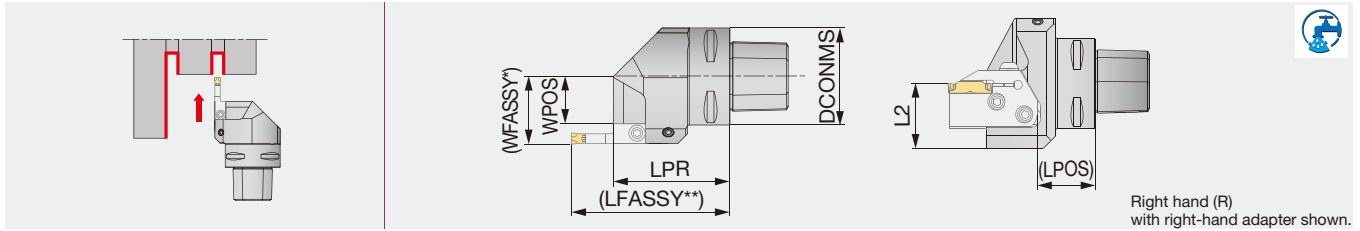

Right hand (R)
with right-hand adapter shown.

Designation	DCONMS	LPR	LPOS	L2	WPOS	Adapter (Option)
C3CHSR/L22050N	32	50	22.1	35	11.5	CAER/L...
C4CHSR/L27050N	40	50	22.1	36	16.5	CAER/L...
C5CHSR/L35060N	50	60	32.1	36	24.5	CAER/L...
C6CHSR/L45065N	63	65	32.1	41	34.5	CAER/L...

WFASSY* : Toolholder (WPOS) + adapter (WF)

LFASSY** : Toolholder (LPOS) + adapter (LF)

Depend on the adapter type, the value of LFASSY or WFASSY may change. If needed, the coolant direction can be adjusted by the nozzle.

Applicable for 7 MPa coolant. Not compatible with TungModularSystem.

C-CHFVR/L

Toolholder with TungCap connection for adapter, perpendicularly mounted

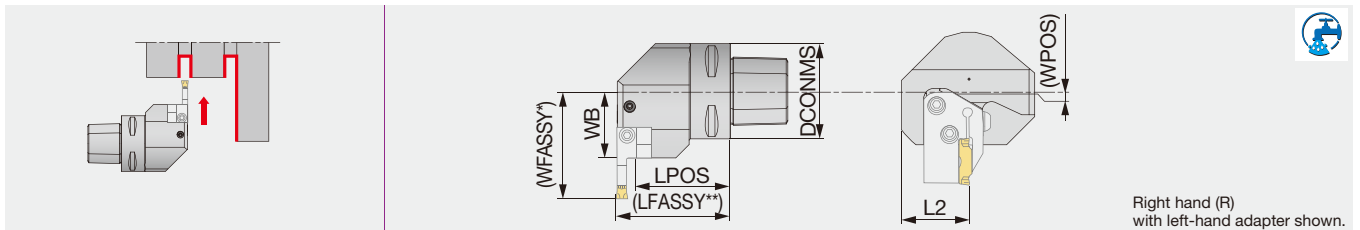

Right hand (R)
with left-hand adapter shown.

Designation	DCONMS	LPOS	L2	WB	WPOS	Adapter (Option)
C3CHFVR/L22040N	32	32.5	35	22	-5.9	CAEL/R...
C4CHFVR/L27050N	40	42.5	36	27	-0.9	CAEL/R...
C5CHFVR/L35060N	50	49.5	36	35	7.1	CAEL/R...
C6CHFVR/L45065N	63	54.5	41	45	17.1	CAEL/R...

WFASSY* : Toolholder (WPOS) + adapter (LF)

LFASSY** : Toolholder (LPOS) + adapter (WF)

Depend on the adapter type, the value of LFASSY or WFASSY may change. If needed, the coolant direction can be adjusted by the nozzle.

Applicable for 7 MPa coolant. Not compatible with TungModularSystem.

SPARE PARTS

Designation	Coolant parts	Clamping screw	Wrench
C3CH**R/L...	SATZ-M8X1-M3	CSHB-6-A	P-4
C4CH**R/L...	SATZ-M8X1-M3	CSHB-6-A	P-4
C5CH**R/L...	SATZ-M10X1-M5	CSHB-6-A	P-4
C6CH**R/L...	SATZ-M10X1-M5	CSHB-6-A	P-4







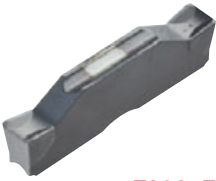
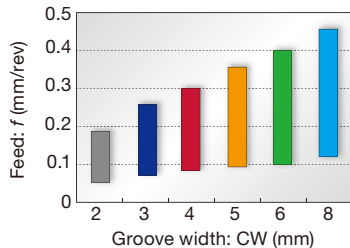

Combination of adapter and toolholder

Toolholder	External grooving adapter		Face grooving adapter	
	CAER...	CAEL...	CAFR...	CAFL...
C*CHSR...	●			●
C*CHSL...		●	●	
C*CHFVR...		●	●	
C*CHFVL...	●			●

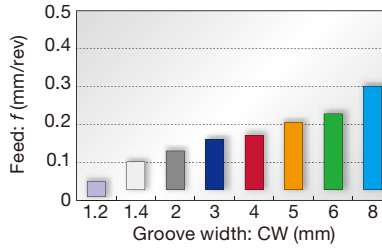
● : Corresponding

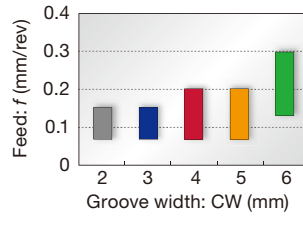
External grooving and parting

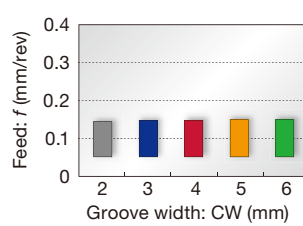

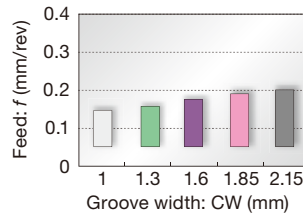
<p>DGM type (2 corners) SGM type (1 corner)</p>  <p>F032, F033</p>	<p>1st choice for grooving and parting</p> <p>Smooth chip evacuation Well-designed edge with high strength Handed insert available CW = 2 - 8 mm</p>	<p>Standard feed</p>  <p>Feed: f (mm/rev)</p> <p>Groove width: CW (mm)</p>
<p>DGS type (2 corners) SGS type (1 corner)</p>  <p>F034, F035</p>	<p>Lower cutting force and superior sharpness</p> <p>Unique-designed edge and chipbreaker Handed insert available CW = 1.2 - 8 mm</p>	<p>Standard feed</p>  <p>Feed: f (mm/rev)</p> <p>Groove width: CW (mm)</p>
<p>DGL type (2 corners)</p>  <p>F035</p>	<p>1st choice for mild steel</p> <p>Chipbreaker with excellent chip control at low feed Suitable for mild steel that often gives difficulties in chip control CW = 2 - 6 mm</p>	<p>Standard feed</p>  <p>Feed: f (mm/rev)</p> <p>Groove width: CW (mm)</p>
<p>DGG type (2 corners)</p>  <p>F036</p>	<p>For non-ferrous materials and titanium</p> <p>Chipbreaker with low cutting force Sharp cutting edge that prevents vibration and delivers fine surface finish CW = 2 - 6 mm</p>	<p>Standard feed</p>  <p>Feed: f (mm/rev)</p> <p>Groove width: CW (mm)</p>
<p>DGE type (2 corners)</p>  <p>F036</p>	<p>For high accurate and shallow groove</p> <p>Excellent chip control CW = 1 - 2.15 mm</p>	<p>Standard feed</p>  <p>Feed: f (mm/rev)</p> <p>Groove width: CW (mm)</p>

Please see page F*** for the product details.

External and face grooving, and turning

**DTM type
(2 corners)**



F037

General purpose

1st choice for grooving and turning
Suitable for light to medium cutting
Excellent chip control in machining steel, alloy steel, stainless steel, and heat-resistant alloy
CW = 2 - 8 mm

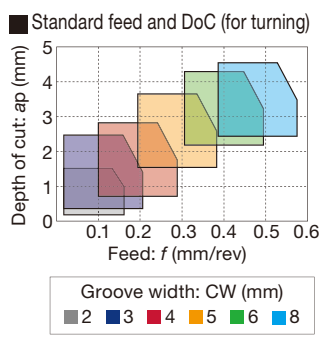

Standard feed and DoC (for turning)

Depth of cut: ap (mm)

Feed: f (mm/rev)

Groove width: CW (mm)

- 2
- 3
- 4
- 5
- 6
- 8

Standard feed

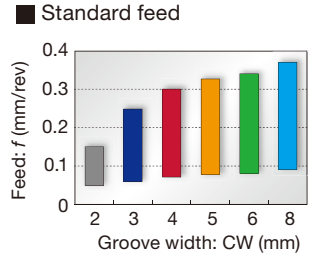

Feed: f (mm/rev)

Groove width: CW (mm)

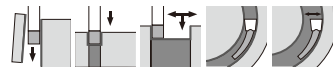

**DTE type
(2 corners)**



F037, F038

General purpose

Unique chipbreaker makes chips shorter
Molded and ground insert available
CW = 2.65 - 8 mm

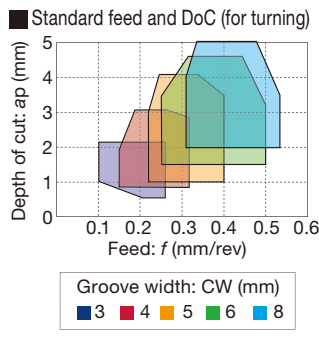

Standard feed and DoC (for turning)

Depth of cut: ap (mm)

Feed: f (mm/rev)

Groove width: CW (mm)

- 3
- 4
- 5
- 6
- 8

Standard feed

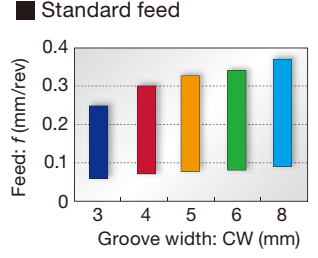

Feed: f (mm/rev)

Groove width: CW (mm)

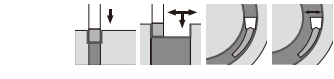

External, internal and face grooving, and turning

**DTX type
(2 corners)**



F038

Multi-functional type

Well balanced sharpness and strength
Multi-functional insert
CW = 2 - 8 mm

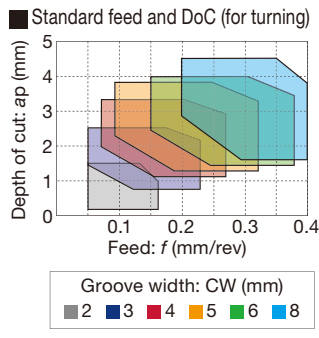

Standard feed and DoC (for turning)

Depth of cut: ap (mm)

Feed: f (mm/rev)

Groove width: CW (mm)

- 2
- 3
- 4
- 5
- 6
- 8

Standard feed

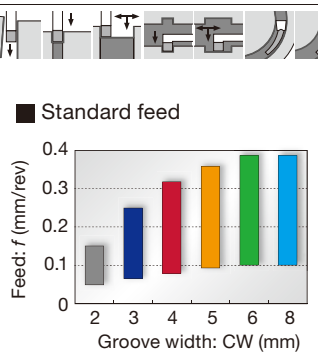

Feed: f (mm/rev)

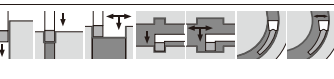

Groove width: CW (mm)



Please see page F*** for the product details.



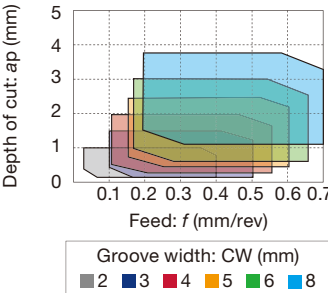
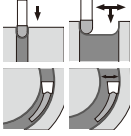

Profiling and undercutting

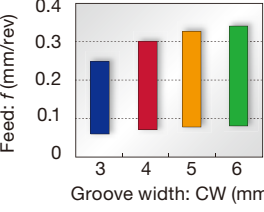
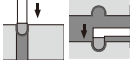

<p>DTR type (2 corners) STR type (1 corner)</p> <p>Molded DTR, STR</p>  <p>Ground DTR</p>  <p>F039, F040</p>	<p>Full radius type</p> <p>Excellent chip control Molded and ground inserts available CW = 2 - 8 mm</p>	<p>■ Standard feed and DoC (for turning)</p> 	
---	--	---	---

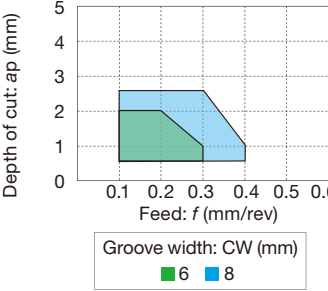
<p>DTIU type (2 corners)</p>  <p>F040</p>	<p>Full radius type</p> <p>Excellent chip control for undercutting CW = 3 - 6 mm</p>	<p>■ Standard feed and DoC</p> 	
---	---	---	---

Aluminium wheel machining

<p>DTA type (2 corners)</p>  <p>F041</p>	<p>Full radius type</p> <p>Excellent chip control For aluminium wheel profiling Ground insert CW = 6 - 8 mm</p>	<p>■ Standard feed and DoC (for turning)</p> 	
--	--	--	--

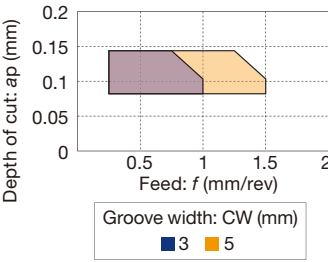
For high feed external and face turning of hardened steel parts

<p>STH type (1 corner)</p>  <p>F041</p>	<p>External and face turning of hardened steel parts</p> <p>High efficiency machining using light D.O.C. and increased feeds CW = 3, 5 mm</p>	<p>■ Standard feed and DoC (for turning)</p> 	
---	--	---	---

External grooving of hardened steel

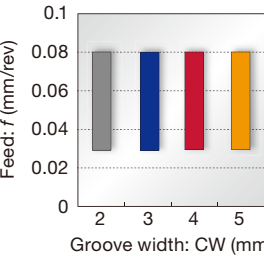
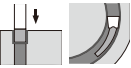
<p>SGN-CBN type (1 corner)</p>  <p>F042</p>	<p>For hardened steel cutting</p> <p>Optimum cutting edge shape for grooving of hardened steels High tolerance width for finishing CW = 2 - 5 mm (CW = ±0.025 mm)</p>	<p>■ Standard feed</p> 	
---	---	---	---

Please see page F*** for the product details.

GRADE SELECTION

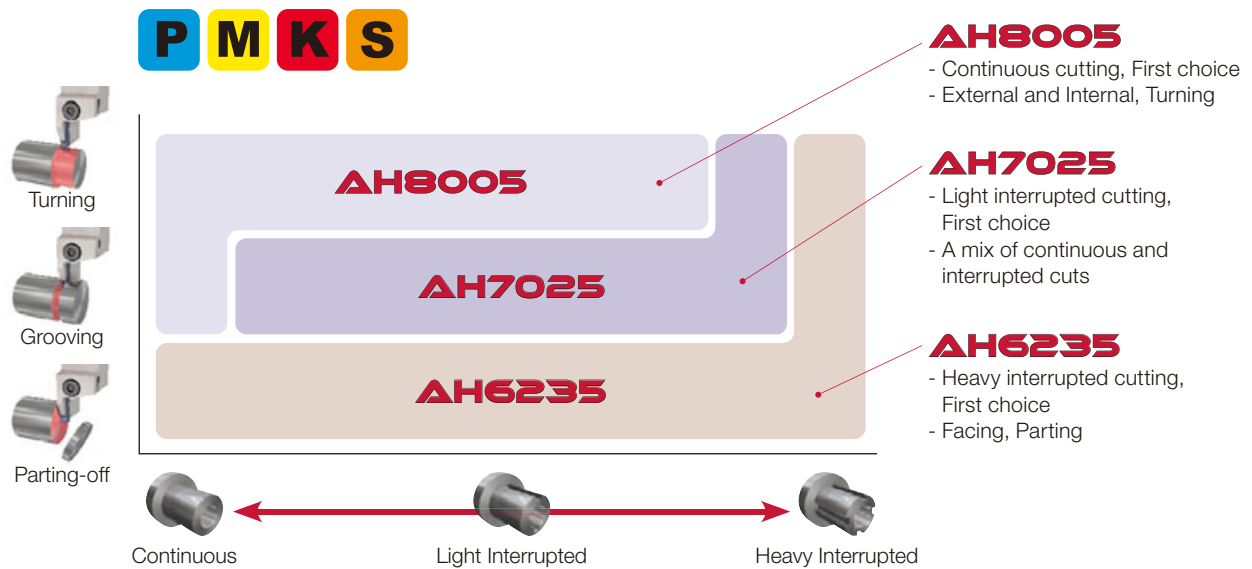

GRADES

AH8005 **P M K S**

- First choice for external, internal, and side-turning, continuous cuts

AH7025 **P M K S**

- First choice for light interrupted cuts or a mix of continuous and interrupted cuts
- New PVD coating with high Al content provides excellent adhesion strength
- Improved wear and chipping resistance

AH6235 **P M K**

- First choice for heavy interrupted cuts, as well as parting and facing applications

AH725 **P M S**

- General purpose PVD grade for high fracture resistance

T515 **K**

- First recommended grade for cast iron
- Excellent wear resistance in high speed machining

T9225 **P**

- Suitable for steel machining at high speeds
- New CVD coating and substrate deliver an outstanding balance of wear and chipping resistance

NS9530 **P**

- Advanced cermet for finish cutting of steel
- Innovative grade with incredible fracture and high wear resistance

GH130 **P M K**

- Recommended for interrupted machining
- TiCNO PVD coating layer with high wear resistance
- High hardness wear resistance

AH905 **S**

- Remarkable for machining of heat resistant alloys
- Exclusive coating layer improves adhesion strength and wear resistance

KS05F **N S**

- Recommended for non-ferrous materials and titanium

TH10 **N**

- Recommended for non-ferrous materials

BXA10 **H**

- Coated CBN grade designed for turning hardened steel parts

BX360 **H**

- Developed for grooving applications of hardened steel parts

INSERTS

DGM

External grooving and parting

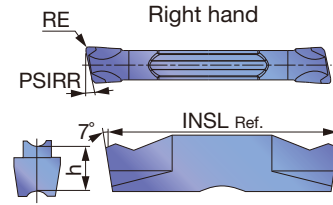
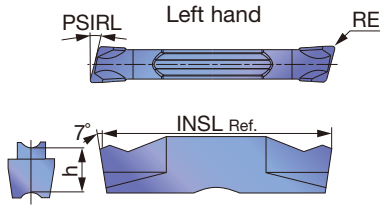
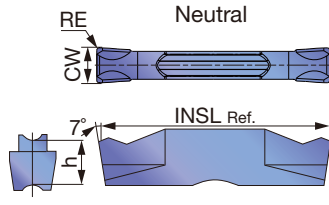

P Steel	★	★	☆	★	☆	★	★	★	★	★						
M Stainless		★	☆	★	★	★	★	★	★	★						
K Cast iron		★	★	★	☆	☆	★		☆				☆			
N Non-ferrous													☆			
S Superalloys		★	☆	★	★								★			
H Hard materials																

★ : First choice
☆ : Second choice

Designation	Seat size	HAND	CW±0.05	RE	Coated							Cermet	Uncoated		INSL	h	PSIRL	PSIRR
					T9225	AH7025	AH725	AH8005	AH905	GH130	AH6235	NS9630	KS05F					
DGM2-020	2	N	2	0.2	●	●	●	●	●	●	●	●	●	●	20	5	0°	0°
DGM2-020-6R	2	R	2	0.2	●	●	●	●	●	●	●	●	●	●	20	5	0°	6°
DGM2-020-6L	2	L	2	0.2	●	●	●	●	●	●	●	●	●	●	20	5	6°	0°
DGM2-020-8R	2	R	2	0.2	●	●	●	●	●	●	●	●	●	●	20	5	0°	8°
DGM2-020-8L	2	L	2	0.2	●	●	●	●	●	●	●	●	●	●	20	5	8	0°
DGM2-020-15R	2	R	2	0.2	●	●	●	●	●	●	●	●	●	●	20	5	0°	15°
DGM2-020-15L	2	L	2	0.2	●	●	●	●	●	●	●	●	●	●	20	5	15°	0°
DGM2-002-15R	2	R	2	0.02	●	●	●	●	●	●	●	●	●	●	19.35	5	0°	15°
DGM2-002-15L	2	L	2	0.02	●	●	●	●	●	●	●	●	●	●	19.35	5	15°	0°
DGM2.39-020	2	N	2.39	0.2	●	●	●	●	●	●	●	●	●	●	20	5	0°	0°
DGM3-020	3	N	3	0.2	●	●	●	●	●	●	●	●	●	●	20	5	0°	0°
DGM3-020-6R	3	R	3	0.2	●	●	●	●	●	●	●	●	●	●	20	5	0°	6°
DGM3-020-6L	3	L	3	0.2	●	●	●	●	●	●	●	●	●	●	20	5	6°	0°
DGM3-002-6R	3	R	3	0.02	●	●	●	●	●	●	●	●	●	●	19.45	5	0°	6°
DGM3-002-6L	3	L	3	0.02	●	●	●	●	●	●	●	●	●	●	19.45	5	6°	0°
DGM3-020-15R	3	R	3	0.2	●	●	●	●	●	●	●	●	●	●	20	5	0°	15°
DGM3-020-15L	3	L	3	0.2	●	●	●	●	●	●	●	●	●	●	20	5	15°	0°
DGM3.18-020	3	N	3.18	0.2	●	●	●	●	●	●	●	●	●	●	20	5	0°	0°
DGM4-030	4	N	4	0.3	●	●	●	●	●	●	●	●	●	●	20	5	0°	0°
DGM4-030-4R	4	R	4	0.3	●	●	●	●	●	●	●	●	●	●	20	5	0°	4°
DGM4-030-4L	4	L	4	0.3	●	●	●	●	●	●	●	●	●	●	20	5	4°	0°
DGM4-030-15R	4	R	4	0.3	●	●	●	●	●	●	●	●	●	●	20	5	0°	15°
DGM4-030-15L	4	L	4	0.3	●	●	●	●	●	●	●	●	●	●	20	5	15°	0°
DGM4.76-040	5	N	4.76	0.4	●	●	●	●	●	●	●	●	●	●	25	5.5	0°	0°
DGM5-030	5	N	5	0.3	●	●	●	●	●	●	●	●	●	●	25	5.5	0°	0°
DGM5-030-4R	5	R	5	0.3	●	●	●	●	●	●	●	●	●	●	25	5.5	0°	4°
DGM6-030	6	N	6	0.3	●	●	●	●	●	●	●	●	●	●	25	5.5	0°	0°
DGM6.35-040	6	N	6.35	0.4	●	●	●	●	●	●	●	●	●	●	25	5.5	0°	0°
DGM8-040	8	N	8	0.4	●	●	●	●	●	●	●	●	●	●	30	6.7	0°	0°

● : Line up

Reference pages: Toolholders → **F014 - F027**, Standard cutting conditions → **F043**

SGM

External deep grooving and parting

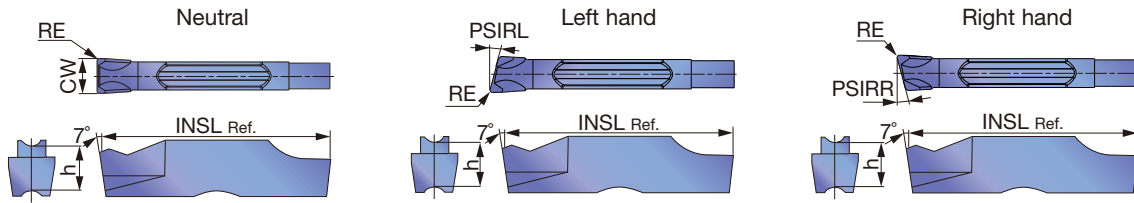

P	Steel	★	☆	★	☆	★								
M	Stainless	★	☆	★	★	★								
K	Cast iron	★		★	☆	★		☆						
N	Non-ferrous							☆						
S	Superalloys	★	☆	★				★						
H	Hard materials													

★ : First choice
☆ : Second choice

Designation	Seat size	HAND	CW±0.05	RE	Coated					Uncoated					INSL	h	PSIRL	PSIRR
					AH7025	AH725	AH8005	GH130	AH6235	KS05F								
SGM2-020	2	N	2	0.2	●	●	●	●	●	●					20	5	0°	0°
SGM2-020-6R	2	R	2	0.2	●	●		●							20	5	0°	6°
SGM2-020-6L	2	L	2	0.2	●	●		●							20	5	6°	0°
SGM3-020	3	N	3	0.2	●	●	●	●	●	●					20	5	0°	0°
SGM3-020-6R	3	R	3	0.2	●	●		●							20	5	0°	6°
SGM3-020-6L	3	L	3	0.2	●	●		●							20	5	6°	0°
SGM3-020-15R	3	R	3	0.2	●	●		●							20	5	0°	15°
SGM3-020-15L	3	L	3	0.2	●	●		●							20	5	15°	0°
SGM4-030	4	N	4	0.3	●	●	●	●	●	●					20	5	0°	0°
SGM4-030-4R	4	R	4	0.3	●	●		●							20	5	0°	4°
SGM4-030-4L	4	L	4	0.3	●	●		●							20	5	4°	0°
SGM5-030	5	N	5	0.3	●	●	●	●	●	●					25	5.5	0°	0°
SGM6-030	6	N	6	0.3	●	●	●	●	●	●					25	5.5	0°	0°
SGM8-040	8	N	8	0.4	●		●		●	●					30	6.7	0°	0°

● : Line up

External grooving and parting

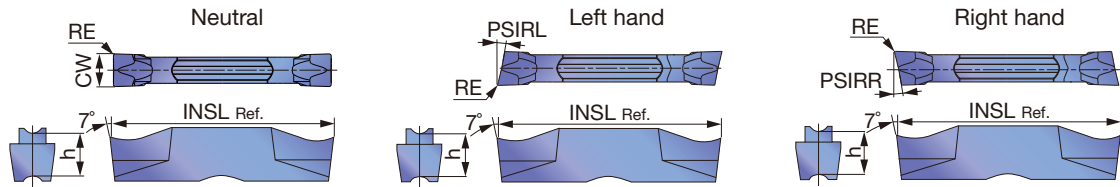

P	Steel	★	★	☆	★	☆	★	★						
M	Stainless		★	☆	★	★	★							
K	Cast iron		★		★	☆	★		☆					
N	Non-ferrous											☆		
S	Superalloys		★	☆	★							★		
H	Hard materials													

★ : First choice
☆ : Second choice

Designation	Seat size	HAND	CW±0.05	RE	Coated						Cermet		Uncoated		INSL	h	PSIRL	PSIRR
					T9225	AH7025	AH725	AH8005	GH130	AH6235	NS9530		KS05F					
DGS1.2-003	0.9	N	1.2	0.03			●								16	4.7	0°	0°
DGS1.4-005	1	N	1.4	0.05			●								16	4.3	0°	0°
DGS1.4-010	1	N	1.4	0.1			●								16	4.3	0°	0°
DGS1.4-016	1	N	1.4	0.16		●	●		●						16	4.3	0°	0°
DGS2-005	2	N	2	0.05			●								20	5	0°	0°
DGS2-010	2	N	2	0.1			●								20	5	0°	0°
DGS2-020	2	N	2	0.2	●	●	●	●	●	●	●		●		20	5	0°	0°
DGS2-020-6R	2	R	2	0.2		●	●		●						20	5	0°	6°
DGS2-020-6L	2	L	2	0.2		●	●		●						20	5	6°	0°
DGS2-002-6R	2	R	2	0.02			●		●						19.5	5	0°	6°
DGS2-002-6L	2	L	2	0.02			●		●						19.5	5	6°	0°
DGS2-020-15R	2	R	2	0.2		●	●		●						20	5	0°	15°
DGS2-020-15L	2	L	2	0.2		●	●		●						20	5	15°	0°
DGS2-002-15R	2	R	2	0.02			●		●						19.5	5	0°	15°
DGS2-002-15L	2	L	2	0.02			●		●						19.5	5	15°	0°
DGS2.39-020	2	N	2.39	0.2		●		●		●			●		20	5	0°	0°
DGS3-020	3	N	3	0.2	●	●	●	●	●	●	●		●		20	5	0°	0°
DGS3-020-6R	3	R	3	0.2		●	●		●						20	5	0°	6°
DGS3-020-6L	3	L	3	0.2		●	●		●						20	5	6°	0°
DGS3-002-6R	3	R	3	0.02			●		●						19.45	5	0°	6°
DGS3-002-6L	3	L	3	0.02			●		●						19.45	5	6°	0°
DGS3-020-15R	3	R	3	0.2		●	●		●						20	5	0°	15°
DGS3-020-15L	3	L	3	0.2		●	●		●						20	5	15°	0°
DGS3-002-15R	3	R	3	0.02			●		●						19.45	5	0°	15°
DGS3-002-15L	3	L	3	0.02			●		●						19.45	5	15°	0°
DGS3.18-020	3	N	3.18	0.2		●		●		●			●		20	5	0°	0°
DGS4-030	4	N	4	0.3	●	●	●	●	●	●	●		●		20	5	0°	0°
DGS4-030-4R	4	R	4	0.3		●	●		●						20	5	0°	4°
DGS4-030-4L	4	L	4	0.3		●	●		●						20	5	4°	0°
DGS4.76-040	5	N	4.76	0.4		●		●		●					25	5.5	0°	0°
DGS5-030	5	N	5	0.3	●	●	●	●	●	●	●		●		25	5.5	0°	0°
DGS6-030	6	N	6	0.3	●	●	●	●	●	●	●		●		25	5.5	0°	0°
DGS6.35-040	6	N	6.35	0.4		●		●		●					25	5.5	0°	0°
DGS8-040	8	N	8	0.4		●		●		●			●		30	6.7	0°	0°

● : Line up

Caution

The tool will interfere with the workpiece when grooving larger diameters than øDmax.

Designation	øDmax (mm)	Designation	øDmax (mm)
DGM2-002-15R/L	28	DGS2-002-15R/L	28
DGM3-002-15R/L	29	DGS3-002-15R/L	29
DGM4-030-15R/L	30	SGS3-020-15R/L	103
SGM3-020-15R/L	103	SGS3-002-15R/L	34

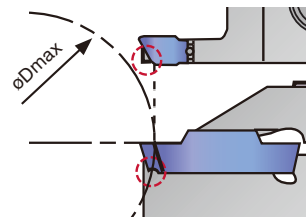

Reference pages: Toolholders → F014 - F027, Standard cutting conditions → F043

SGS

External deep grooving and parting

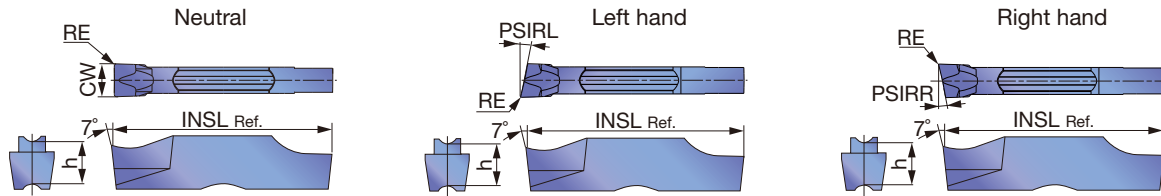

P Steel	★	☆	★	☆	★								
M Stainless	★	☆	★	★	★								
K Cast iron	★		★	☆	★		☆						
N Non-ferrous							☆						
S Superalloys	★	☆	★				★						
H Hard materials													

★ : First choice
☆ : Second choice

Designation	Seat size	HAND	CW±0.05	RE	Coated					Uncoated				INSL	h	PSIRL	PSIRR
					AH7025	AH725	AH8005	GH130	AH6235	KS05F							
SGS2-020	2	N	2	0.2	●	●	●	●	●	●				20	5	0°	0°
SGS2-020-6R	2	R	2	0.2	●	●	●	●	●	●				20	5	0°	6°
SGS2-020-6L	2	L	2	0.2	●	●	●	●	●	●				20	5	6°	0°
SGS2-020-15R	2	R	2	0.2	●	●	●	●	●	●				20	5	0°	15°
SGS2-020-15L	2	L	2	0.2	●	●	●	●	●	●				20	5	15°	0°
SGS3-020	3	N	3	0.2	●	●	●	●	●	●				20	5	0°	0°
SGS3-020-6R	3	R	3	0.2	●	●	●	●	●	●				20	5	0°	6°
SGS3-020-6L	3	L	3	0.2	●	●	●	●	●	●				20	5	6°	0°
SGS3-002-6R	3	R	3	0.02	●	●	●	●	●	●				19.8	5	0°	6°
SGS3-002-6L	3	L	3	0.02	●	●	●	●	●	●				19.8	5	6°	0°
SGS3-020-15R	3	R	3	0.2	●	●	●	●	●	●				20	5	0°	15°
SGS3-020-15L	3	L	3	0.2	●	●	●	●	●	●				20	5	15°	0°
SGS3-002-15R	3	R	3	0.02	●	●	●	●	●	●				19.8	5	0°	15°
SGS3-002-15L	3	L	3	0.02	●	●	●	●	●	●				19.8	5	15°	0°
SGS4-030	4	N	4	0.3	●	●	●	●	●	●				20	5	0°	0°
SGS5-030	5	N	5	0.3	●	●	●	●	●	●				25	5.5	0°	0°
SGS6-030	6	N	6	0.3	●	●	●	●	●	●				25	5.5	0°	0°
SGS8-040	8	N	8	0.4	●	●	●	●	●	●				30	6.7	0°	0°

● : Line up

DGL

External grooving and parting

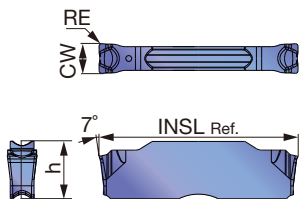

P Steel	★	★	★										
M Stainless	★	★	★										
K Cast iron	★	★	★										
N Non-ferrous													
S Superalloys	★	★											
H Hard materials													

★ : First choice
☆ : Second choice

Designation	Seat size	CW±0.05	RE	Coated			INSL	h
				AH7025	AH8005	AH6235		
DGL2-020	2	2	0.2	●	●	●	20	5
DGL3-025	3	3	0.25	●	●	●	20	5
DGL4-030	4	4	0.3	●	●	●	20	5
DGL5-030	5	5	0.3	●	●	●	25	5.5
DGL6-080	6	6	0.8	●	●	●	25	5.5

● : Line up

Reference pages: Toolholders → **F014 - F027**, Standard cutting conditions → **F043**

DGG

External grooving (for high precision)

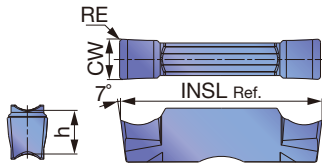

P	Steel	★		★						
M	Stainless	★								
K	Cast iron	★		☆		☆				
N	Non-ferrous						★			
S	Superalloys	★				☆				
H	Hard materials									

★ : First choice
☆ : Second choice

Designation	Seat size	CW±0.02	RE	Coated			Cermet			Uncoated			INSL	h
				AH7025			NS9530			KS05F				
DGG200-020	2	2	0.2	●			●			●			20	5
DGG300-020	3	3	0.2	●			●			●			20	5
DGG400-040	4	4	0.4	●			●			●			20	5
DGG500-040	5	5	0.4	●			●			●			25	5.5
DGG600-040	6	6	0.4	●			●			●			25	5.5

● : Line up

DGE

External grooving (for high precision)

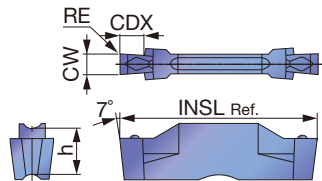

P	Steel	★	☆	☆		★					
M	Stainless	★	☆	★							
K	Cast iron	★		☆		☆					
N	Non-ferrous										
S	Superalloys	★	☆								
H	Hard materials										

★ : First choice
☆ : Second choice

Designation	Seat size	CW±0.02	RE	Coated			Cermet			CDX	INSL	h
				AH7025	AH725	GH130	NS9530					
DGE100-000	2	1	0	●	●		●			2.5	20	5
DGE130-000	2	1.3	0	●	●		●			2.5	20	5
DGE160-010	2	1.6	0.1	●	●	●	●			2.5	20	5
DGE185-010	2	1.85	0.1	●	●	●	●			3.5	20	5
DGE215-015	2	2.15	0.15	●	●	●	●			3.5	20	5

● : Line up

Caution

øDmax is limited as shown in the picture to the right according to the groove depth, G.D. Please refer to the following table.

G.D. = Groove depth

Designation	Max. groove depth (mm)	øDmax (mm)				
		G.D. = 1	G.D. = 1.5	G.D. = 2	G.D. = 2.5	G.D. = 3
DGE100-000	2	∞	18.6	11.5	-	-
DGE130-000						
DGE160-010						
DGE185-010	3				8.8	7
DGE215-015						

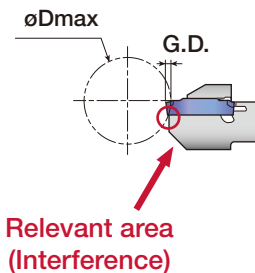

Relevant area (Interference)

Reference pages: Toolholders → F014 - F027, Standard cutting conditions → F043

DTM

External face grooving and turning

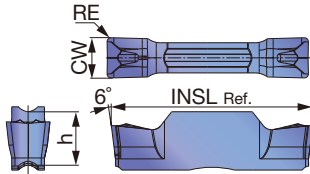

P Steel	★	★	★							
M Stainless	★	★	★							
K Cast iron	★	★	★							
N Non-ferrous										
S Superalloys	★	★								
H Hard materials										

★ : First choice
☆ : Second choice

Designation	Seat size	CW±0.05	RE	Coated				INSL	h
				AH7025	AH8005	AH6235			
DTM2-020	2	2	0.2	●	●	●		20	5
DTM3-030	3	3	0.3	●	●	●		20	5
DTM4-040	4	4	0.4	●	●	●		20	5
DTM4-080	4	4	0.8	●	●	●		20	5
DTM5-080	5	5	0.8	●	●	●		25	5.5
DTM6-080	6	6	0.8	●	●	●		25	5.5
DTM8-080	8	8	0.8	●	●	●		30	6.7

● : Line up

DTE

External face grooving and turning (for high precision)

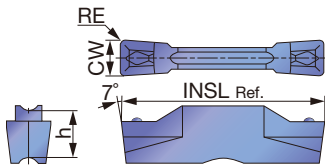

P Steel	★	★	☆	☆				★			
M Stainless	★	★	☆	★							
K Cast iron	★	★	☆	☆							
N Non-ferrous											
S Superalloys	★	☆									
H Hard materials											

★ : First choice
☆ : Second choice

Designation	Seat size	CW±0.02	RE	Coated				Cermet	INSL	h
				T9225	AH7025	AH725	GH130	NS9530		
DTE265-015	3	2.65	0.15	●	●	●	●	●	20	5
DTE300-020	3	3	0.2	●	●	●	●	●	20	5
DTE300-040	3	3	0.4	●	●	●	●	●	20	5
DTE315-015	3	3.15	0.15	●	●	●	●	●	20	5
DTE400-040	4	4	0.4	●	●	●	●	●	20	5
DTE400-080	4	4	0.8	●	●	●	●	●	20	5
DTE415-015	4	4.15	0.15	●	●	●	●	●	20	5
DTE478-055	5	4.78	0.55	●	●	●	●	●	25	5.5
DTE500-040	5	5	0.4	●	●	●	●	●	25	5.5
DTE500-080	5	5	0.8	●	●	●	●	●	25	5.5
DTE515-015	5	5.15	0.15	●	●	●	●		25	5.5
DTE600-080	6	6	0.8	●	●	●	●		25	5.5
DTE600-120	6	6	1.2	●	●	●	●		25	5.5
DTE800-080	8	8	0.8	●	●	●	●		30	6.7
DTE800-120	8	8	1.2	●	●	●	●		30	6.7

● : Line up

Reference pages: Toolholders → **F014 - F027**, Standard cutting conditions → **F043**

DTE

External face grooving and turning

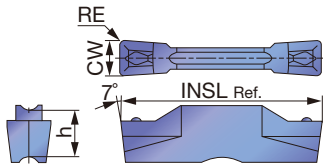

P	Steel	★		★	☆	★	☆	★		★					
M	Stainless			★	☆	★	★	★							
K	Cast iron		★	★		★	☆	★							
N	Non-ferrous														
S	Superalloys			★	☆	★									
H	Hard materials														

★ : First choice
☆ : Second choice

Designation	Seat size	CW±0.05	RE	Coated						Cermet		INSL	h
				T9225	T515	AH7025	AH725	AH8005	GH130	AH6235	NS9530		
DTE3-020	3	3	0.2			●		●		●		20	5
DTE3-040	3	3	0.4	●	●	●	●	●	●	●		20	5
DTE4-040	4	4	0.4	●	●	●	●	●	●	●		20	5
DTE4-080	4	4	0.8			●		●		●		20	5
DTE5-040	5	5	0.4		●	●		●		●		25	5.5
DTE5-080	5	5	0.8			●		●		●		25	5.5
DTE6-080	6	6	0.8		●	●		●		●		25	5.5

● : Line up

DTX

External, internal and face grooving, and turning

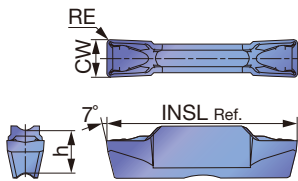

P	Steel	★	★	☆	★	☆	★		★						
M	Stainless		★	☆	★	★	★								
K	Cast iron		★		★	☆	★		☆			☆			
N	Non-ferrous											☆			
S	Superalloys		★	☆	★							★			
H	Hard materials														

★ : First choice
☆ : Second choice

Designation	Seat size	CW±0.05	RE	Coated						Cermet		Uncoated		INSL	h
				T9225	AH7025	AH725	AH8005	GH130	AH6235	NS9530		KS05F			
DTX2-020	2	2	0.2		●		●		●			●		20	5
DTX3-030	3	3	0.3	●	●	●	●	●	●	●		●		20	5
DTX4-040	4	4	0.4	●	●	●	●	●	●	●		●		20	5
DTX5-040	5	5	0.4	●	●	●	●	●	●	●		●		25	5.5
DTX6-080	6	6	0.8		●	●	●	●	●			●		25	5.5
DTX8-080	8	8	0.8		●		●		●			●		30	6.7

● : Line up

Reference pages: Toolholders → **F014 - F027**, Standard cutting conditions → **F043**

DTR

Profiling and undercutting (for high precision)

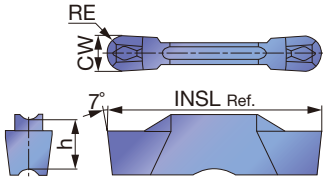

P	Steel	★	★	☆	☆				★				
M	Stainless		★	☆	★								
K	Cast iron		★		☆				☆				
N	Non-ferrous												
S	Superalloys		★	☆									
H	Hard materials												

★ : First choice
☆ : Second choice

Designation	Seat size	CW±0.02	RE	Coated				Cermet		INSL	h
				T9225	AH7025	AH725	GH130	NS9530			
DTR300-150	3	3	1.5	●	●	●	●	●		20	5
DTR400-200	4	4	2	●	●	●	●	●		20	5
DTR478-239	5	4.78	2.39	●	●	●	●	●		25	5.5
DTR500-250	5	5	2.5	●	●	●	●	●		25	5.5
DTR600-300	6	6	3	●	●	●	●			25	5.5

● : Line up

DTR

Profiling and undercutting

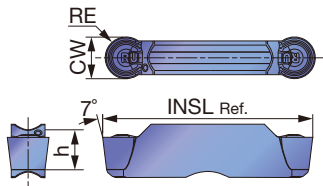

P	Steel	★	★	☆	★		☆	★		★			
M	Stainless		★	☆	★		★	★					
K	Cast iron		★		★	☆	☆	★		☆			
N	Non-ferrous									☆			
S	Superalloys		★	☆	★	★				★			
H	Hard materials												

★ : First choice
☆ : Second choice

Designation	Seat size	CW±0.05	RE	Coated						Cermet		Uncoated		INSL	h
				T9225	AH7025	AH725	AH8005	AH905	GH130	AH6235	NS9530		KS05F		
DTR2-100	2	2	1		●		●				●			20	5
DTR3-150	3	3	1.5	●	●	●	●	●	●	●				20	5
DTR4-200	4	4	2	●	●	●	●	●	●	●				20	5
DTR5-250	5	5	2.5	●	●	●	●	●	●	●				25	5.5
DTR6-300	6	6	3	●	●	●	●	●	●					25	5.5
DTR8-400	8	8	4	●	●	●	●	●	●					30	6.7

● : Line up

Reference pages: Toolholders → **F014 - F027**, Standard cutting conditions → **F043**

STR

Profiling and undercutting

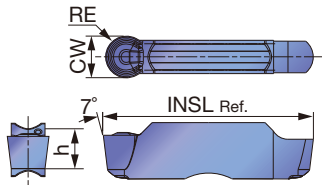

P	Steel	★	★																	
M	Stainless	★	★																	
K	Cast iron	★	★																	☆
N	Non-ferrous																			☆
S	Superalloys	★	★																	★
H	Hard materials																			

★ : First choice
☆ : Second choice

Designation	Seat size	CW±0.05	RE	Coated						Uncoated		INSL	h
				AH7025	AH8005					KS05F			
STR2-100	2	2	1	●	●					●		20	5
STR3-150	3	3	1.5	●	●					●		20	5
STR4-200	4	4	2	●	●					●		20	5
STR5-250	5	5	2.5	●	●					●		25	5.5
STR6-300	6	6	3	●	●					●		25	5.5
STR8-400	8	8	4	●	●					●		30	6.7

●: Line up

DTIU

Profiling and undercutting (for high precision)

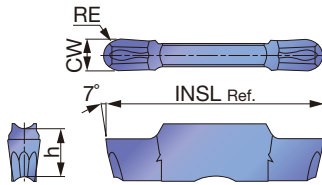

P	Steel	★	☆	☆																
M	Stainless	★	☆	★																
K	Cast iron	★		☆																
N	Non-ferrous																			
S	Superalloys	★	☆																	
H	Hard materials																			

★ : First choice
☆ : Second choice

Designation	Seat size	CW±0.02	RE	Coated									INSL	h	
				AH7025	AH725	GH130									
DTIU300-150	3	3	1.5	●	●	●								20	5
DTIU400-200	4	4	2	●	●	●								20	5
DTIU500-250	5	5	2.5	●	●	●								25	5.5
DTIU600-300	6	6	3	●	●	●								25	5.5

●: Line up

Reference pages: Toolholders → **F014 - F027**, Standard cutting conditions → **F043**

DTA

Aluminium wheel machining (for high precision)

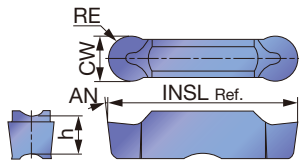

P	Steel									
M	Stainless									
K	Cast iron									
N	Non-ferrous	★								
S	Superalloys									
H	Hard materials									

★ : First choice
☆ : Second choice

Designation	Seat size	CW±0.02	RE	Uncoated							INSL	h	AN
				TH10									
DTA600-300	6	6	3	●							25	5.5	7°
DTA800-400	8	8	4	●							30	6.7	10°

●: Line up

STH

External and face turning

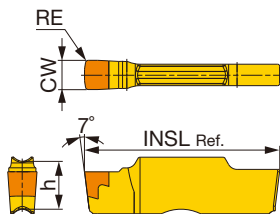

P	Steel									
M	Stainless									
K	Cast iron									
N	Non-ferrous									
S	Superalloys									
H	Hard materials	★								

★ : First choice

Designation	Seat size	CW±0.025	RE	CBN							INSL	h
				BXA10								
STH300-SR	3	3	0.3	●							20	5
STH500-SR	5	5	0.3	●							25	5.5

●: Line up

SGN

External grooving

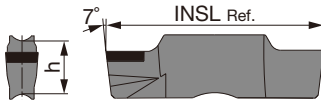
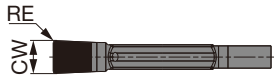

P	Steel												
M	Stainless												
K	Cast iron												
N	Non-ferrous												
S	Superalloys												
H	Hard materials	★											

★ : First choice
☆ : Second choice

Designation	Seat size	CW±0.025	RE	CBN								INSL	h	Condition			
				BX360											Continuous	Light interrupted	Heavy interrupted
SGN200-020	2	2	0.2	●									20	5	○		
SGN200-020-S	2	2	0.2	●									20	5		○	
SGN200-020-H	2	2	0.2	●									20	5			○
SGN300-020	3	3	0.2	●									20	5	○		
SGN300-020-S	3	3	0.2	●									20	5		○	
SGN300-020-H	3	3	0.2	●									20	5			○
SGN400-020	4	4	0.2	●									20	5	○		
SGN400-020-S	4	4	0.2	●									20	5		○	
SGN400-020-H	4	4	0.2	●									20	5			○
SGN500-020-S	5	5	0.2	●									25	5.5			○
SGN500-020-H	5	5	0.2	●									25	5.5			○

●: Line up

Edge preparations

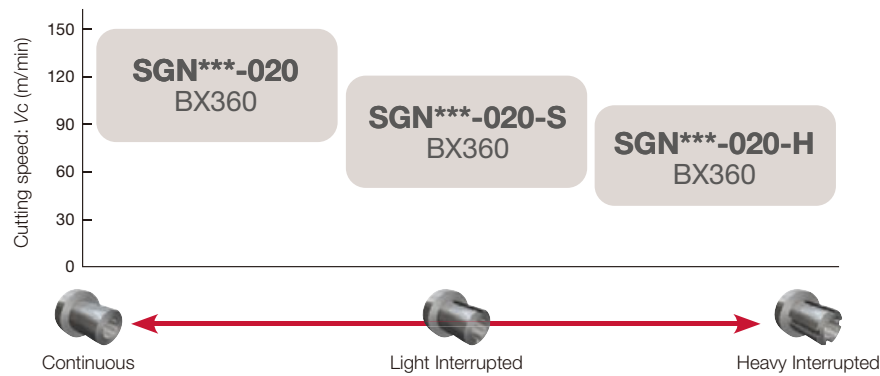
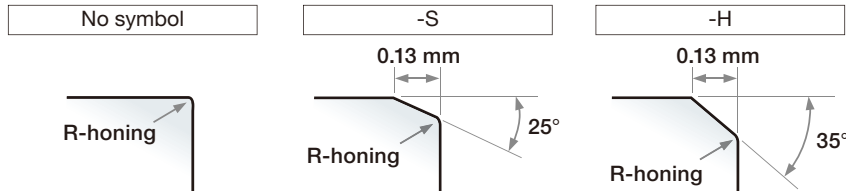

Reference pages: Toolholders → **F014 - F027**, Standard cutting conditions → **F043**

STANDARD CUTTING CONDITIONS

ISO	Workpiece material	Hardness	Priority	Grade	Cutting speed Vc (m/min)
P	Steel S45C, SCM435, etc. C45, 34CrMo4, etc.	< 300 HB	First choice	AH7025, AH725	50 - 180
		< 300 HB	Wear resistance	T9225, AH8005	80 - 300
		< 300 HB	Impact resistance	AH6235, GH130	50 - 120
		< 300 HB	Surface quality	NS9530	80 - 220
M	Stainless steel SUS303, SUS304, etc. X10CrNiS18-9, X5CrNi18-9, etc.	< 200 HB	First choice	AH7025, AH725	50 - 120
		< 200 HB	Wear resistance	AH8005	50 - 120
		< 200 HB	Impact resistance	AH6235, GH130	50 - 120
K	Grey cast iron FC250, etc. 250, etc.	-	First choice	T515	150 - 700
		-	Impact resistance	AH8005, AH7025, AH6235, GH130	50 - 180
	Ductile cast iron FCD450, etc. 450-10S, etc.	-	First choice	T515	150 - 300
		-	Impact resistance	AH8005, AH7025, AH6235, GH130	50 - 120
N	Aluminium alloys Si < 12%	-	First choice	TH10	100 - 500
		-	First choice	KS05F	100 - 600
S	Superalloys Inconel718, etc.	< HRC 40	First choice	AH8005	20 - 60
		< HRC 40	Impact resistance	AH7025, AH725, AH6235	20 - 40
	Titanium alloys Ti-6Al-4V, etc.	< HRC 40	First choice	KS05F	20 - 100
		< HRC 40	Impact resistance	AH7025, AH725	20 - 80

Please see page **F028 - F030** for feed: *f* (mm/rev).

STH

ISO	Grade	CW	Application	Cutting speed Vc (m/min)	Depth of cut ap (mm)	Feed f (mm/rev)
H	BXA10	3	External turning	100 - 230	0.08 - 0.12	0.4 - 1
			Face turning	100 - 230	0.08 - 0.12	0.4 - 0.8
		5	External turning	100 - 230	0.08 - 0.12	0.5 - 1.5
			Face turning	100 - 230	0.08 - 0.12	0.5 - 0.8

SGN

ISO	Grade	Edge preparation	Workpiece condition	Cutting speed Vc (m/min)	Feed f (mm/rev)
H	BX360	No symbol	Continuous	80 - 150	0.03 - 0.08
		-S	Light interrupted	50 - 120	0.03 - 0.08
		-H	Heavy interrupted	40 - 100	0.03 - 0.06

Grade
Insert
Ext. Toolholder
Int. Toolholder
Threading
Grooving
Miniature tool
Milling cutter
Endmill
Drilling tool
Tooling System
User's Guide
Index



Precision grooving tools with uniquely shaped insert for swiss type machine and general lathes

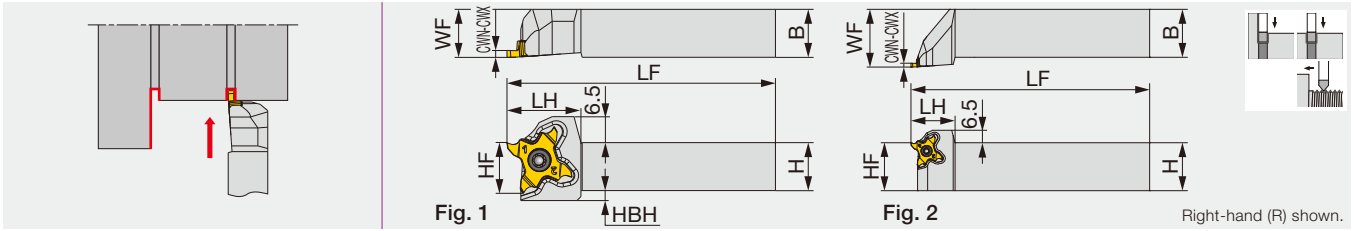

Designation	CWN	CWX	H	B	LF	LH	HF	WF	HBH	Insert	Torque*	Fig.
STCR/L1010X18	0.33	3.18	10	10	120	18.5	10	10	4.5	TC*18...	1.2	1
STCR/L1212F18	0.33	3.18	12	12	85	18.5	12	12	2.5	TC*18...	1.2	1
STCR/L1212X18	0.33	3.18	12	12	120	18.5	12	12	2.5	TC*18...	1.2	1
STCR/L1616X18	0.33	3.18	16	16	120	18.5	16	16	-	TC*18...	1.2	1
STCR/L2020H18	0.33	3.18	20	20	100	18.5	20	20	-	TC*18...	1.2	1
STCR/L2020X18	0.33	3.18	20	20	120	23	20	25	-	TC*18...	1.2	2
STCR/L2525Z18	0.33	3.18	25	25	135	23	25	30	-	TC*18...	1.2	2

The right hand insert (TC*18R...) is used for the right hand toolholders (STCR...), and the left hand insert is used for the left hand toolholders
 *Torque: Recommended clamping torque: N·m

STCR/L-18-CHP

Direct connection

External grooving and threading toolholder, high pressure coolant compatible

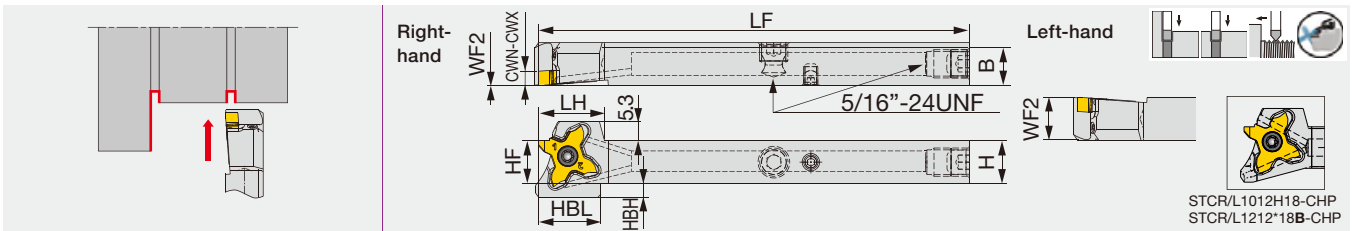

Designation	CWN	CWX	H	B	LF	LH	HBL	HF	WF2	HBH	Insert	Torque*
STCR/L1012H18-CHP	0.33	3.18	10	12	100	17.1	17.1	10	0/12	4	TC*18...	1.2
STCR/L1212X18B-CHP	0.33	3.18	12	12	120	18.5	17.5	12	0/12	4	TC*18...	1.2
STCR/L1616X18-CHP	0.33	3.18	16	16	120	18.5	-	16	0/16	0	TC*18...	1.2

The right hand insert (TC*18R...) is used for the right hand toolholders (STCR...), and the left hand insert (TC*18L...) is used for the left hand toolholders (STCL...)
 *Torque: Recommended torque (N·m) for clamping

SPARE PARTS

Designation	Clamping screw	Wrench	Coolant plug	Wrench	DirectJet plug	Wrench
STCR**18	CSTC-4L100DL	T-1008/5	-	-	-	-
STCL**18	CSTC-4L100DR	T-1008/5	-	-	-	-
STCL**18-CHP	CSTC-4L100DR	T-1008/5	SR5/16UNFTL360	P-4	SSHM4-6-TB	P-2
STCR**18-CHP	CSTC-4L100DL	T-1008/5	SR5/16UNFTL360	P-4	SSHM4-6-TB	P-2

Reference pages: Inserts → **F051 - F057**, Standard cutting conditions → **F058**
 Parts for coolant hose → **F266**

STCR/L-18-CHP

Tube connection

External grooving and threading toolholder. High pressure coolant capability.

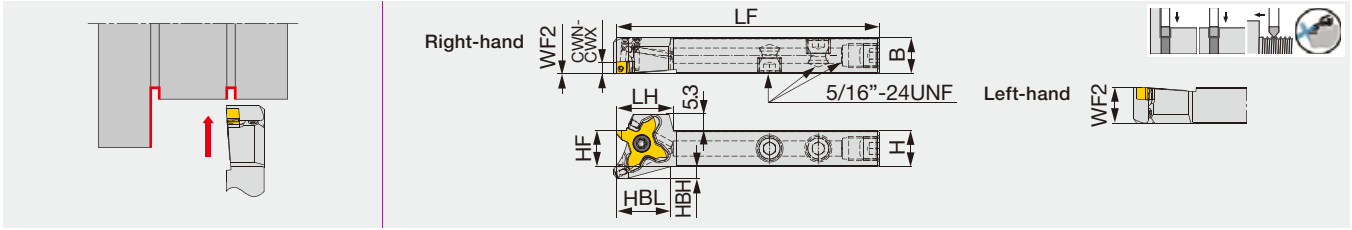

Designation	CWN	CWX	H	B	LF	LH	HBL	HF	WF2 ⁽¹⁾	HBH	Insert	Torque*
STCR/L1212F18B-CHP	0.33	3.18	12	12	85	18.5	17.5	12	0/12	4	TC*18...	1.2

The right hand insert (TC*18R**) is used for the right hand toolholders (STCR**), and the left hand insert (TC*18L**) is used for the left hand toolholders (STCL**).
 (1) "0/12" for the WF2 dimension indicates WF2 = 0 for the right handed tool, WF2 = 12 for the left handed tool.
 *Torque: Recommended torque (N·m) for clamping

STCR/L-18-CHP

Tube connection

Threading tool - for external threading with high pressure coolant capability

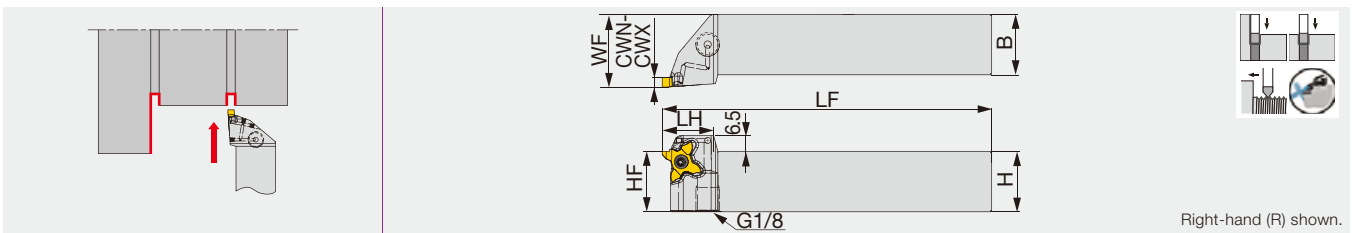

Designation	CWN	CWX	H	B	LF	LH	HBL	HF	WF	HBH	Insert	Torque*
STCR/L2020X18-CHP	0.33	3.18	20	20	120	23	-	20	25	-	TC*18...	1.2
STCR/L2525Z18-CHP	0.33	3.18	25	25	135	23	-	25	30	-	TC*18...	1.2

Use the right hand insert (TC*18R...) with the right hand toolholders (STCR...). Use the left hand insert (TC*18L...) with the left hand holder (STCL...).
 *Torque: Recommended torque (N·m) for clamping

SPARE PARTS

Designation	Clamping screw	Wrench	Coolant plug	Wrench
STCL**F18B-CHP	CSTC-4L100DR	T-1008/5	SR5/16UNFTL360	P-4
STCR**F18B-CHP	CSTC-4L100DL	T-1008/5	SR5/16UNFTL360	P-4
STCL**18-CHP	CSTC-4L100DR	T-1008/5	-	-
STCR**18-CHP	CSTC-4L100DL	T-1008/5	-	-

Reference pages: Inserts → **F051 - F057**, Standard cutting conditions → **F058**
 Parts for coolant hose → **F266**

Grade
Insert
Ext. Toolholder
Int. Toolholder
Threading
Grooving
Miniature tool
Milling cutter
Endmill
Drilling tool
Tooling System
User's Guide
Index



External grooving and threading toolholder with round shank, for Swiss lathes

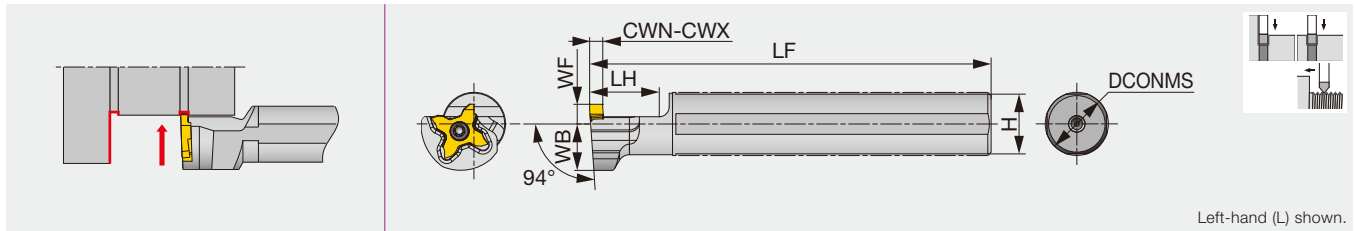

Designation	CWN	CWX	DCONMS	LF	LH	H	WB	WF	Insert	Torque*
JS14H-STCL18	0.33	3.18	14	100	20	13	14	6	TC*18R...	1.2
JS159F-STCL18	0.33	3.18	15.875	85	20	15	14	6	TC*18R...	1.2
JS16F-STCL18	0.33	3.18	16	85	20	15	14	6	TC*18R...	1.2
JS19G-STCL18	0.33	3.18	19.05	90	20	18	14	6	TC*18R...	1.2
JS19X-STCL18	0.33	3.18	19.05	120	20	18	14	6	TC*18R...	1.2
JS20G-STCL18	0.33	3.18	20	90	20	19	14	6	TC*18R...	1.2
JS20X-STCL18	0.33	3.18	20	120	20	19	14	6	TC*18R...	1.2
JS22X-STCL18	0.33	3.18	22	120	20	21	12.25	10	TC*18R...	1.2
JS25H-STCL18	0.33	3.18	25	100	20	24	12.25	10	TC*18R...	1.2
JS254X-STCL18	0.33	3.18	25.4	120	20	24	12.25	10	TC*18R...	1.2

The left hand toolholder (STCL...) is used with the right hand inserts (TC*18R...)

*Torque: Recommended clamping torque: N·m

STCAR/L18-CHP

External grooving and threading adapter, with high pressure coolant capability

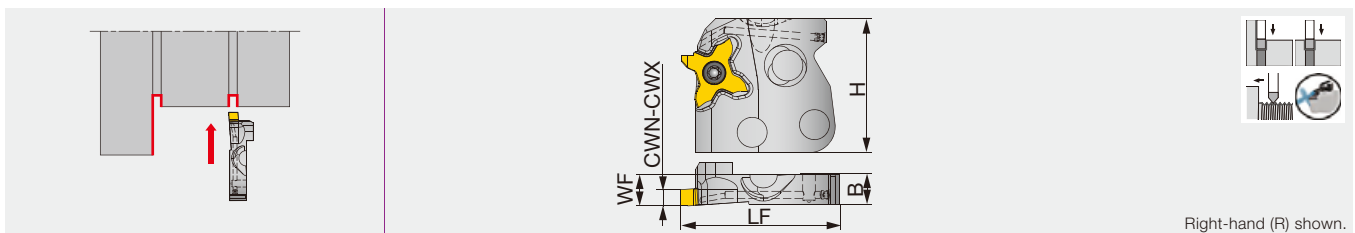

Designation	CWN	CWX	WF	H	LF	B	Insert	Torque*
STCAR/L18-CHP	0.33	3.18	7.5	33	38	7.2	TC*18...	1.2

Use the right hand insert (TC*18R...) with the right hand adapter (STCAR...). Use the left hand insert (TC*18L...) with the left hand adapter (STCAL...).

*Torque: Recommended torque (N·m) for clamping

SPARE PARTS



Designation	Clamping screw	Wrench
JS**STCL18	CSTC-4L100DL	T-1008/5
STCAL18-CHP	CSTC-4L100DR	T-1008/5
STCAR18-CHP	CSTC-4L100DL	T-1008/5

Reference pages: JS-STCL18: Inserts → **F051 - F057**, Standard cutting conditions → **F058**

STCAR/L18-CHP: Inserts → **F051 - F057**, Shanks and toolholders → **F047 - F049**

Standard cutting conditions → **F058**, Technical Reference → **L053**

CHSR/L-CHP

Tube connection

Shank for adapter, with high pressure coolant capability

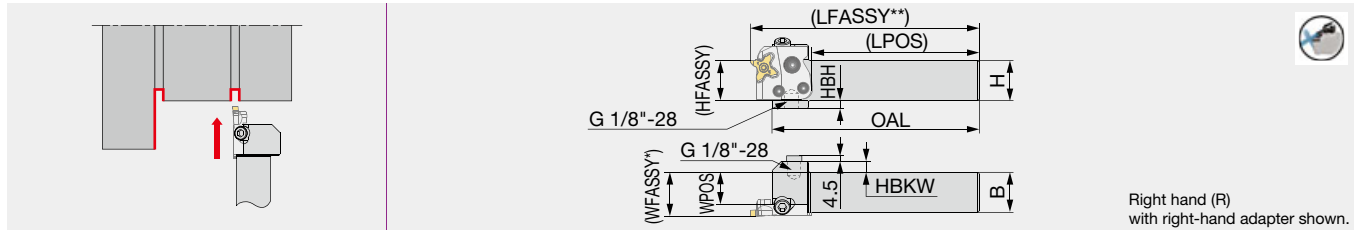

Designation	H	B	OAL	LPOS	WPOS	HBKW	HFASSY	HBH	Adapter (Option)	Torque*
CHSR/L2020-CHP	20	20	130	105.5	15.1	12	20	10	STCAR/L18-CHP	6.5
CHSR/L2525-CHP	25	25	130	105.5	20.1	7	25	5	STCAR/L18-CHP	6.5

WFASSY* : Shank (WPOS) + adapter (WF)

LFASSY** : Shank (LPOS) + adapter (LF)

Depend on the adapter type, the value of LFASSY or WFASSY may change.

Torque*: Recommended clamping torque (N·m)

Applicable for 30 MPa coolant

Please see page L053 for instructions on installing and removing the adapter or the insert.

CHSR/L-CHP-MC

Direct connection

Shank for adapter, with high pressure coolant capability

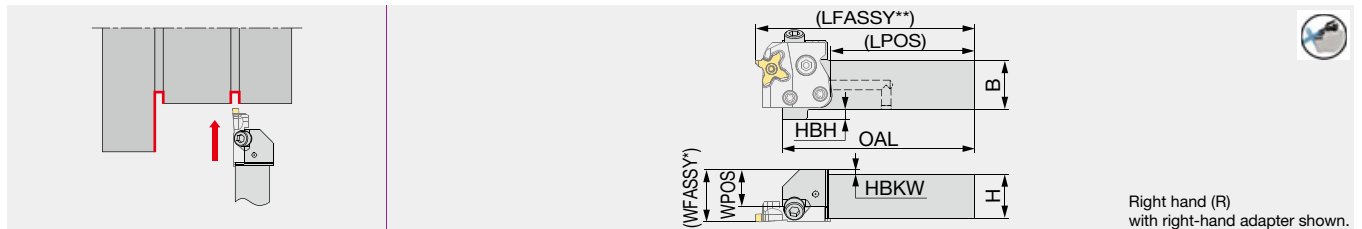

Designation	H	B	OAL	LPOS	WPOS	HBKW	HBH	Adapter (Option)	Torque*
CHSR/L2020-CHP-MC	20	20	98	73.5	14	6	10	STCAR/L18-CHP	6.5
CHSR/L2525-CHP-MC	25	25	98	73.5	19	-	5	STCAR/L18-CHP	6.5

WFASSY* : Shank (WPOS) + adapter (WF)

LFASSY** : Shank (LPOS) + adapter (LF)

Depend on the adapter type, the value of LFASSY or WFASSY may change.

Torque*: Recommended clamping torque (N·m)

Applicable for 30 MPa coolant

Please see page L053 for instructions on installing and removing the adapter or the insert.

SPARE PARTS

Designation	Clamping screw 1	Wrench 1	Clamping screw 2	Clamping screw 3	Wrench 2	O-ring	Plug
CHSR/L*-CHP	SR M5-04451	T-20/5	SR M6X12DIN6912	SR M6X20-XT	HW5.0	OR 5X1N	PLUGG1/8ISO1179
CHSR/L*-CHP-MC	SR M5-04451	T-20/5	SR M6X12DIN6912	SR M6X20-XT	HW5.0	OR 5X1N	-

Recommended clamping torque (N·m)

Clamping screw	Torque (N·m)
SR M5-04451	2.5
SR M6X12DIN6912	6.5
SR M6X20-XT	6.5

Combination of adapter and shank

Shank	Adapter	
	STCAR18-CHP	STCAL18-CHP
CHSR**-CHP (-MC)	●	
CHSL**-CHP (-MC)		●
CHFVR**-CHP		●
CHFVL**-CHP	●	

● : Corresponding

Reference pages: Inserts → F051 - F057, Adapters → F046, Standard cutting conditions → F058
Parts for coolant hose → F266, Technical Reference → L053

Shank for perpendicularly-mounted adapter, with high pressure coolant capability

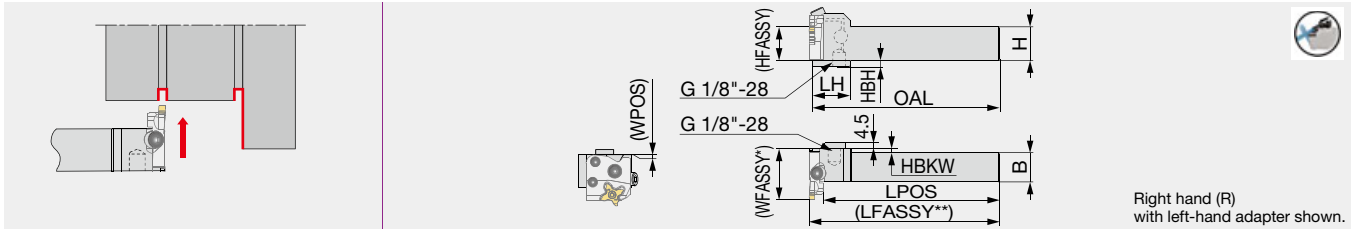

Right hand (R)
with left-hand adapter shown.

Designation	H	B	OAL	LH	LPOS	WPOS	HBKW	HFASSY	HBH	Adapter (Option)	Torque*
CHFVR/L2020-CHP	20	20	140	28	135.1	0.5	5	20	10	STCAL/R18-CHP	6.5
CHFVR/L2525-CHP	25	25	140	28	135.1	0.5	0	25	5	STCAL/R18-CHP	6.5

WFASSY* : Shank (WPOS) + adapter (LF)

LFASSY** : Shank (LPOS) + adapter (WF)

Depend on the adapter type, the value of LFASSY or WFASSY may change.

Torque*: Recommended clamping torque (N·m)

Applicable for 30 MPa coolant

Please see page L053 for instructions on installing and removing the adapter or the insert.

SPARE PARTS

Designation	Clamping screw 1	Wrench 1	Clamping screw 2	Clamping screw 3	Wrench 2	O-ring	Plug
CHFVR/L...	SR M5-04451	T-20/5	SR M6X12DIN6912	SR M6X20-XT	HW5.0	OR 5X1N	PLUGG1/8ISO1179

Recommended clamping torque (N·m)

Clamping screw	Torque (N·m)
SR M5-04451	2.5
SR M6X12DIN6912	6.5
SR M6X20-XT	6.5

Combination of adapter and shank

Shank	Adapter	
	STCAR18-CHP	STCAL18-CHP
CHSR**-CHP (-MC)	●	
CHSL**-CHP (-MC)		●
CHFVR**-CHP		●
CHFVL**-CHP	●	

● : Corresponding

C*CHSN-CHP

Direct connection

Toolholder with TungCap connection, for adapter, with high pressure coolant capability

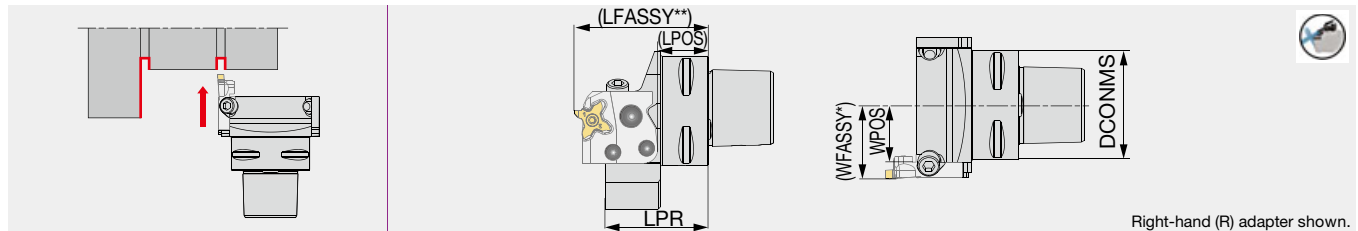

Right-hand (R) adapter shown.

Designation	DCONMS	LPR	LPOS	WPOS	Adapter (Option)	Torque*
C3CHSN19045-CHP	32	45	17.5	18.5	STCAR/L18-CHP	6.5
C4CHSN21047-CHP	40	46.5	21.5	21	STCAR/L18-CHP	6.5
C5CHSN26047-CHP	50	47	22.5	26	STCAR/L18-CHP	6.5
C6CHSN33050-CHP	63	50	24.5	32.5	STCAR/L18-CHP	6.5

WFASSY* : Toolholder (WPOS) + adapter (WF)

LFASSY** : Toolholder (LPOS) + adapter (LF)

Depend on the adapter type, the value of LFASSY or WFASSY may change.

Torque*: Recommended clamping torque (N·m)

Applicable for 30 MPa coolant

Please see page L053 for instructions on installing and removing the adapter or the insert.

C*CHFVN-CHP

Direct connection

Toolholder with TungCap connection, for perpendicularly-mounted adapter, with high pressure coolant capability

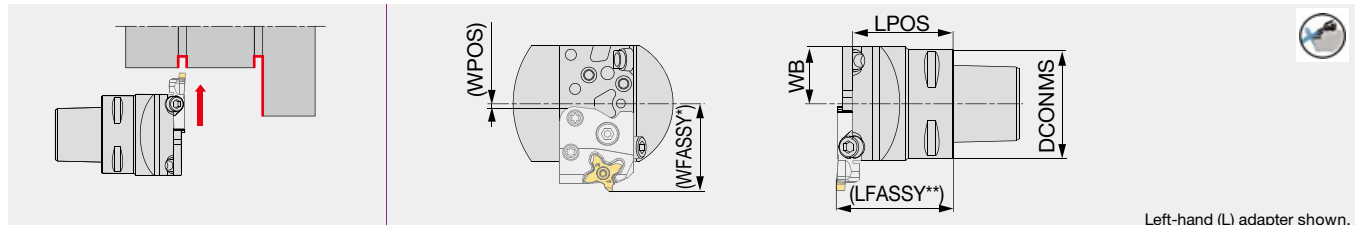

Left-hand (L) adapter shown.

Designation	DCONMS	LPOS	WB	WPOS	Adapter (Option)	Torque*
C3CHFVN26040-CHP	32	40	26	1.5	STCAR/L18-CHP	6.5
C4CHFVN26046-CHP	40	46	26	1.5	STCAR/L18-CHP	6.5
C5CHFVN26046-CHP	50	46	26	1.5	STCAR/L18-CHP	6.5
C6CHFVN33046-CHP	63	46	33	8.5	STCAR/L18-CHP	6.5

WFASSY* : Toolholder (WPOS) + adapter (LF)

LFASSY** : Toolholder (LPOS) + adapter (WF)

Depend on the adapter type, the value of LFASSY or WFASSY may change.

Torque*: Recommended clamping torque (N·m)

Applicable for 30 MPa coolant

Please see page L053 for instructions on installing and removing the adapter or the insert.

SPARE PARTS

Designation	Clamping screw 1	Wrench 1	Clamping screw 2	Clamping screw 3	Wrench 2	O-ring
C*CH**N*-CHP	SR M5-04451	T-20/5	SR M6X12DIN6912	SR M6X20-XT	HW5.0	OR 5X1N

Recommended clamping torque (N·m)

Clamping screw	Torque (N·m)
SR M5-04451	2.5
SR M6X12DIN6912	6.5
SR M6X20-XT	6.5

Reference pages: Inserts → F051 - F057, Adapters → F046, Standard cutting conditions → F058
 Technical Reference → L053

TETRAMCUT

C-STCR/L-18-CHP

External grooving and threading toolholder, with high pressure coolant capability

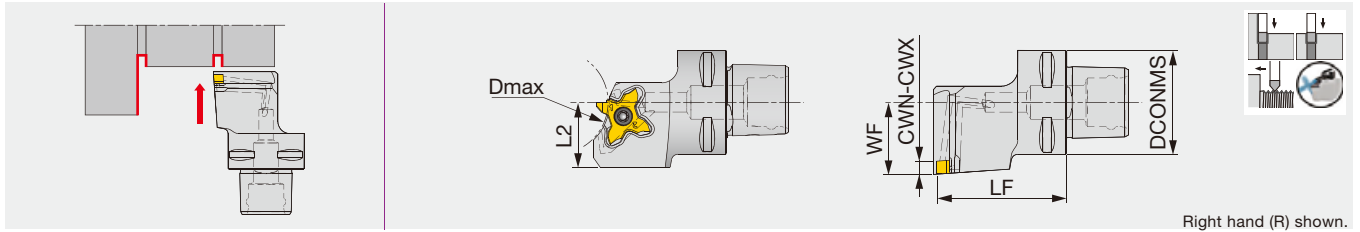

Designation	CWN	CWX	DCONMS	LF	L2	WF	Dmax	Insert	Torque*
C3STCR/L22040-18-CHP	0.33	3.18	32	40	20	22	32	TC*18...	1.2
C4STCR/L27050-18-CHP	0.33	3.18	40	50	25	27	75 ⁽¹⁾	TC*18...	1.2

Applicable for 14 MPa coolant

Use the right hand insert (TC*18R...) with the right hand holder (STCR...). Use the left hand insert (TC*18L...) with the left hand holder (STCL...).

(1) The value for 3.5 mm groove depth. Dmax varies according to the grooving depth required.

*Torque: Recommended clamping torque (N·m)

C-STCFL-18-CHP

External grooving and threading toolholder, with high pressure coolant capability

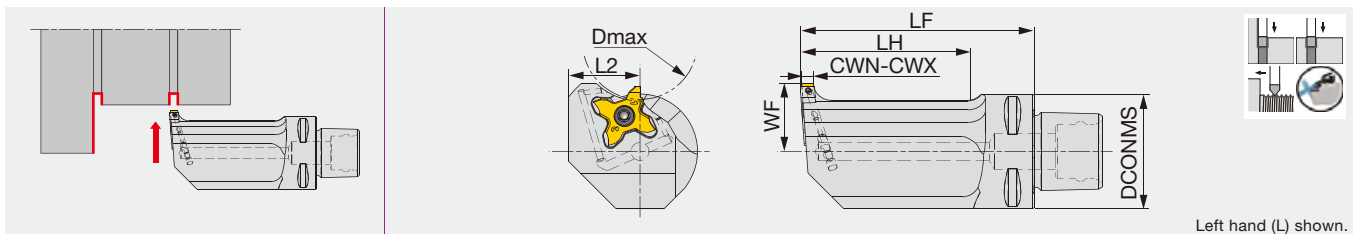

Designation	CWN	CWX	DCONMS	LF	LH	L2	WF	Dmax	Insert	Torque*
C3STCFL18040-18-CHP	0.33	3.18	32	40	21.5	20	18	32	TC*18R...	1.2
C3STCFL18065-18-CHP	0.33	3.18	32	65	46.5	20	18	32	TC*18R...	1.2

Applicable for 14 MPa coolant

Use the right hand insert (TC*18R...) with the left hand holder (STCFL...).









*Torque: Recommended clamping torque (N·m)

SPARE PARTS

Designation	Clamping screw	Wrench
C*STCL*-18-CHP	CSTC-4L100DR	T-1008/5
C*STCR*-18-CHP	CSTC-4L100DL	T-1008/5
C3STCFL*-18-CHP	CSTC-4L100DL	T-1008/5

Reference pages: Inserts → **F051 - F057**, Standard cutting conditions → **F058**

External grooving

<p>TCS18 (4 corners)</p>  <p>F052, F053</p>	<p>First choice for O.D. grooving</p> <p>General-purpose pressed-in 3D chipbreaker for smooth chip control</p> <p>CW = 1 - 3 mm CDX = 3.5 mm</p> 	<p>TCL18 (4 corners)</p>  <p>F053</p>	<p>For lighter cutting action</p> <p>Features pressed-in 3D chipbreaker with sharp cutting edge for light cutting action. Provides excellent chip control at low feed rates.</p> <p>CW = 1.5 - 3 mm CDX = 3.5 mm</p> 
<p>TCG18 (4 corners)</p>  <p>F054, F055</p>	<p>For better chipping resistance</p> <p>Features an optimum rake angle and edge preparation for a good balance of light cutting action and fracture resistance.</p> <p>CW = 1 - 3.18 mm CDX = 3.5 mm</p> 	<p>TCP18 (4 corners)</p>  <p>F056, F057</p>	<p>For higher surface quality</p> <p>Featuring a large rake angle, providing light cutting action and better surface finish. TCP-F style insert is also available for sharp cutting edge.</p> <p>CW = 0.33 - 3 mm CDX = 3.5 mm</p> 

Grade	A
Insert	B
Ext. Toolholder	C
Int. Toolholder	D
Threading	E
Grooving	F
Miniature tool	G
Milling cutter	H
Endmill	I
Drilling tool	J
Tooling System	K
User's Guide	L
Index	M

Please see page **F***** for the product details.

INSERTS

TCS18R/L (3D chipbreaker, honed edge)

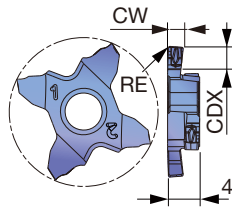

Right-hand (R) shown.

P	Steel	★
M	Stainless	★
K	Cast iron	★
N	Non-ferrous	
S	Superalloys	★
H	Hard materials	

★ : First choice



Designation	HAND	CW±0.02	RE	Coated							CDX
				AH7025							
TCS18R100-010	R	1	0.1	●							2
TCS18L100-010	L	1	0.1	●							2
TCS18R120-010	R	1.2	0.1	●							2
TCS18L120-010	L	1.2	0.1	●							2
TCS18R125-010	R	1.25	0.1	●							2
TCS18L125-010	L	1.25	0.1	●							2
TCS18R125-020	R	1.25	0.2	●							2
TCS18L125-020	L	1.25	0.2	●							2
TCS18R130-020	R	1.3	0.2	●							3.5
TCS18L130-020	L	1.3	0.2	●							3.5
TCS18R140-010	R	1.4	0.1	●							3.5
TCS18L140-010	L	1.4	0.1	●							3.5
TCS18R140-020	R	1.4	0.2	●							3.5
TCS18L140-020	L	1.4	0.2	●							3.5
TCS18R145-010	R	1.45	0.1	●							3.5
TCS18L145-010	L	1.45	0.1	●							3.5
TCS18R150-010	R	1.5	0.1	●							3.5
TCS18L150-010	L	1.5	0.1	●							3.5
TCS18R150-020	R	1.5	0.2	●							3.5
TCS18L150-020	L	1.5	0.2	●							3.5
TCS18R160-020	R	1.6	0.2	●							3.5
TCS18L160-020	L	1.6	0.2	●							3.5
TCS18R170-020	R	1.7	0.2	●							3.5
TCS18L170-020	L	1.7	0.2	●							3.5
TCS18R175-010	R	1.75	0.1	●							3.5
TCS18L175-010	L	1.75	0.1	●							3.5
TCS18R175-020	R	1.75	0.2	●							3.5
TCS18L175-020	L	1.75	0.2	●							3.5
TCS18R185-020	R	1.85	0.2	●							3.5
TCS18L185-020	L	1.85	0.2	●							3.5
TCS18R195-020	R	1.95	0.2	●							3.5
TCS18L195-020	L	1.95	0.2	●							3.5
TCS18R200-010	R	2	0.1	●							3.5
TCS18L200-010	L	2	0.1	●							3.5
TCS18R200-020	R	2	0.2	●							3.5
TCS18L200-020	L	2	0.2	●							3.5
TCS18R225-020	R	2.25	0.2	●							3.5
TCS18L225-020	L	2.25	0.2	●							3.5
TCS18R230-020	R	2.3	0.2	●							3.5
TCS18L230-020	L	2.3	0.2	●							3.5
TCS18R250-010	R	2.5	0.1	●							3.5
TCS18L250-010	L	2.5	0.1	●							3.5

5 pieces per package

● : Line up

Reference pages: Toolholders → **F044 - F050**, Standard cutting conditions → **F058**

P	Steel	★								
M	Stainless	★								
K	Cast iron	★								
N	Non-ferrous									
S	Superalloys	★								
H	Hard materials									

★ : First choice

Designation	HAND	CW±0.02	RE	Coated						CDX	
				AH7025							
TCS18R250-020	R	2.5	0.2	●							3.5
TCS18L250-020	L	2.5	0.2	●							3.5
TCS18R250-030	R	2.5	0.3	●							3.5
TCS18L250-030	L	2.5	0.3	●							3.5
TCS18R265-030	R	2.65	0.3	●							3.5
TCS18L265-030	L	2.65	0.3	●							3.5
TCS18R280-030	R	2.8	0.3	●							3.5
TCS18L280-030	L	2.8	0.3	●							3.5
TCS18R300-010	R	3	0.1	●							3.5
TCS18L300-010	L	3	0.1	●							3.5
TCS18R300-020	R	3	0.2	●							3.5
TCS18L300-020	L	3	0.2	●							3.5
TCS18R300-030	R	3	0.3	●							3.5
TCS18L300-030	L	3	0.3	●							3.5

5 pieces per package
● : Line up

TCL18R/L (3D chipbreaker, honed edge)

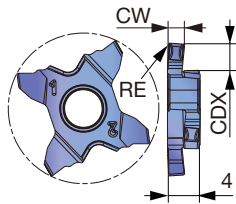

Right-hand (R) shown.

P	Steel	★								
M	Stainless	★								
K	Cast iron	★								
N	Non-ferrous									
S	Superalloys	★								
H	Hard materials									

★ : First choice

Designation	HAND	CW±0.02	RE	Coated						CDX	
				AH7025							
TCL18R150-010	R	1.5	0.1	●							3.5
TCL18L150-010	L	1.5	0.1	●							3.5
TCL18R150-020	R	1.5	0.2	●							3.5
TCL18L150-020	L	1.5	0.2	●							3.5
TCL18R175-020	R	1.75	0.2	●							3.5
TCL18L175-020	L	1.75	0.2	●							3.5
TCL18R200-010	R	2	0.1	●							3.5
TCL18L200-010	L	2	0.1	●							3.5
TCL18R200-020	R	2	0.2	●							3.5
TCL18L200-020	L	2	0.2	●							3.5
TCL18R250-030	R	2.5	0.3	●							3.5
TCL18L250-030	L	2.5	0.3	●							3.5
TCL18R300-010	R	3	0.1	●							3.5
TCL18L300-010	L	3	0.1	●							3.5
TCL18R300-020	R	3	0.2	●							3.5
TCL18L300-020	L	3	0.2	●							3.5
TCL18R300-030	R	3	0.3	●							3.5
TCL18L300-030	L	3	0.3	●							3.5

5 pieces per package
● : Line up

Reference pages: Toolholders → **F044 - F050**, Standard cutting conditions → **F058**



TCG18R/L (honed edge)

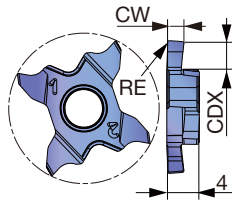

Right-hand (R) shown.

P	Steel	★
M	Stainless	★
K	Cast iron	★
N	Non-ferrous	
S	Superalloys	★
H	Hard materials	

★ : First choice



Designation	HAND	CW±0.02	RE	Coated						CDX	
				AH7025							
TCG18R100-010	R	1	0.1	●							2
TCG18L100-010	L	1	0.1	●							2
TCG18R120-010	R	1.2	0.1	●							2
TCG18L120-010	L	1.2	0.1	●							2
TCG18R125-010	R	1.25	0.1	●							2
TCG18L125-010	L	1.25	0.1	●							2
TCG18R125-020	R	1.25	0.2	●							2
TCG18L125-020	L	1.25	0.2	●							2
TCG18R130-020	R	1.3	0.2	●							2
TCG18L130-020	L	1.3	0.2	●							2
TCG18R140-010	R	1.4	0.1	●							3.5
TCG18L140-010	L	1.4	0.1	●							3.5
TCG18R140-020	R	1.4	0.2	●							3.5
TCG18L140-020	L	1.4	0.2	●							3.5
TCG18R145-010	R	1.45	0.1	●							3.5
TCG18L145-010	L	1.45	0.1	●							3.5
TCG18R145-020	R	1.45	0.2	●							3.5
TCG18L145-020	L	1.45	0.2	●							3.5
TCG18R150-010	R	1.5	0.1	●							3.5
TCG18L150-010	L	1.5	0.1	●							3.5
TCG18R150-020	R	1.5	0.2	●							3.5
TCG18L150-020	L	1.5	0.2	●							3.5
TCG18R160-020	R	1.6	0.2	●							3.5
TCG18L160-020	L	1.6	0.2	●							3.5
TCG18R170-020	R	1.7	0.2	●							3.5
TCG18L170-020	L	1.7	0.2	●							3.5
TCG18R175-010	R	1.75	0.1	●							3.5
TCG18L175-010	L	1.75	0.1	●							3.5
TCG18R175-020	R	1.75	0.2	●							3.5
TCG18L175-020	L	1.75	0.2	●							3.5
TCG18R185-020	R	1.85	0.2	●							3.5
TCG18L185-020	L	1.85	0.2	●							3.5
TCG18R195-020	R	1.95	0.2	●							3.5
TCG18L195-020	L	1.95	0.2	●							3.5
TCG18R200-010	R	2	0.1	●							3.5
TCG18L200-010	L	2	0.1	●							3.5
TCG18R200-020	R	2	0.2	●							3.5
TCG18L200-020	L	2	0.2	●							3.5
TCG18R225-020	R	2.25	0.2	●							3.5
TCG18L225-020	L	2.25	0.2	●							3.5
TCG18R230-020	R	2.3	0.2	●							3.5
TCG18L230-020	L	2.3	0.2	●							3.5
TCG18R250-010	R	2.5	0.1	●							3.5
TCG18L250-010	L	2.5	0.1	●							3.5

5 pieces per package
● : Line up

Reference pages: Toolholders → **F044 - F050**, Standard cutting conditions → **F058**

P	Steel	★							
M	Stainless	★							
K	Cast iron	★							
N	Non-ferrous								
S	Superalloys	★							
H	Hard materials								

★ : First choice

Designation	HAND	CW±0.02	RE	Coated						CDX
				AH7025						
TCG18R250-020	R	2.5	0.2	●						3.5
TCG18L250-020	L	2.5	0.2	●						3.5
TCG18R250-030	R	2.5	0.3	●						3.5
TCG18L250-030	L	2.5	0.3	●						3.5
TCG18R265-030	R	2.65	0.3	●						3.5
TCG18L265-030	L	2.65	0.3	●						3.5
TCG18R280-030	R	2.8	0.3	●						3.5
TCG18L280-030	L	2.8	0.3	●						3.5
TCG18R300-010	R	3	0.1	●						3.5
TCG18L300-010	L	3	0.1	●						3.5
TCG18R300-020	R	3	0.2	●						3.5
TCG18L300-020	L	3	0.2	●						3.5
TCG18R300-030	R	3	0.3	●						3.5
TCG18L300-030	L	3	0.3	●						3.5

5 pieces per package

● : Line up

TCG18R/L (Full R, honed edge)

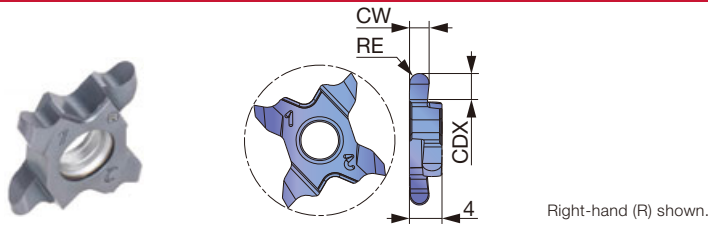

P	Steel	★							
M	Stainless	★							
K	Cast iron	★							
N	Non-ferrous								
S	Superalloys	★							
H	Hard materials								

★ : First choice

Designation	HAND	CW±0.02	RE	Coated						CDX
				AH7025						
TCG18R100-050	R	1	0.5	●						2
TCG18L100-050	L	1	0.5	●						2
TCG18R158-079	R	1.58	0.79	●						3.5
TCG18L158-079	L	1.58	0.79	●						3.5
TCG18R200-100	R	2	1	●						3.5
TCG18L200-100	L	2	1	●						3.5
TCG18R239-120	R	2.39	1.2	●						3.5
TCG18L239-120	L	2.39	1.2	●						3.5
TCG18R300-150	R	3	1.5	●						3.5
TCG18L300-150	L	3	1.5	●						3.5
TCG18R318-159	R	3.18	1.59	●						3.5
TCG18L318-159	L	3.18	1.59	●						3.5

5 pieces per package

● : Line up

Reference pages: Toolholders → **F044 - F050**, Standard cutting conditions → **F058**

TCP18R/L (lightly honed edge)

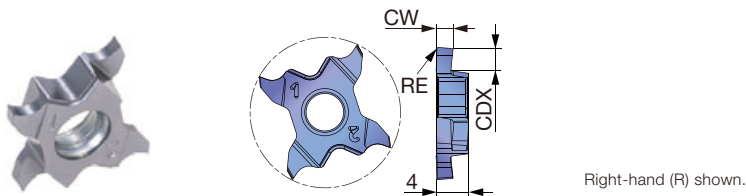

P	Steel	★
M	Stainless	★
K	Cast iron	★
N	Non-ferrous	
S	Superalloys	★
H	Hard materials	

★ : First choice



Designation	HAND	CW±0.02	RE	Coated							CDX
				AH725							
TCP18R033-005	R	0.33	0.05	●							0.8
TCP18L033-005	L	0.33	0.05	●							0.8
TCP18R043-005	R	0.43	0.05	●							1.2
TCP18L043-005	L	0.43	0.05	●							1.2
TCP18R050-005	R	0.5	0.05	●							1.2
TCP18L050-005	L	0.5	0.05	●							1.2
TCP18R075-005	R	0.75	0.05	●							2
TCP18L075-005	L	0.75	0.05	●							2
TCP18R095-005	R	0.95	0.05	●							2
TCP18L095-005	L	0.95	0.05	●							2
TCP18R100-010	R	1	0.1	●							2
TCP18L100-010	L	1	0.1	●							2
TCP18R120-010	R	1.2	0.1	●							2
TCP18L120-010	L	1.2	0.1	●							2
TCP18R125-010	R	1.25	0.1	●							2
TCP18L125-010	L	1.25	0.1	●							2
TCP18R140-010-35	R	1.4	0.1	●							3.5
TCP18L140-010-35	L	1.4	0.1	●							3.5
TCP18R145-010	R	1.45	0.1	●							2
TCP18L145-010	L	1.45	0.1	●							2
TCP18R145-010-35	R	1.45	0.1	●							3.5
TCP18L145-010-35	L	1.45	0.1	●							3.5
TCP18R150-010	R	1.5	0.1	●							2
TCP18L150-010	L	1.5	0.1	●							2
TCP18R150-010-35	R	1.5	0.1	●							3.5
TCP18L150-010-35	L	1.5	0.1	●							3.5
TCP18R175-010	R	1.75	0.1	●							2
TCP18L175-010	L	1.75	0.1	●							2
TCP18R175-010-35	R	1.75	0.1	●							3.5
TCP18L175-010-35	L	1.75	0.1	●							3.5
TCP18R200-010	R	2	0.1	●							2.5
TCP18L200-010	L	2	0.1	●							2.5
TCP18R200-010-35	R	2	0.1	●							3.5
TCP18L200-010-35	L	2	0.1	●							3.5
TCP18R250-010	R	2.5	0.1	●							2.5
TCP18L250-010	L	2.5	0.1	●							2.5
TCP18R250-010-35	R	2.5	0.1	●							3.5
TCP18L250-010-35	L	2.5	0.1	●							3.5
TCP18R300-010	R	3	0.1	●							2.5
TCP18L300-010	L	3	0.1	●							2.5
TCP18R300-010-35	R	3	0.1	●							3.5
TCP18L300-010-35	L	3	0.1	●							3.5

5 pieces per package
● : Line up

Reference pages: Toolholders → **F044 - F050**, Standard cutting conditions → **F058**

TCP18R/L-F (sharp edge)

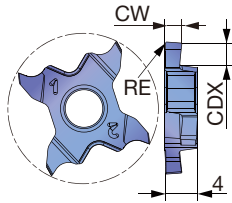

Right-hand (R) shown.

P	Steel	★
M	Stainless	★
K	Cast iron	★
N	Non-ferrous	
S	Superalloys	★
H	Hard materials	

★ : First choice

Designation	HAND	CW±0.02	RE	Coated										CDX			
				SH725													
TCP18R033F-005	R	0.33	0.05	●													0.8
TCP18L033F-005	L	0.33	0.05	●													0.8
TCP18R043F-005	R	0.43	0.05	●													1.2
TCP18L043F-005	L	0.43	0.05	●													1.2
TCP18R050F-005	R	0.5	0.05	●													1.2
TCP18L050F-005	L	0.5	0.05	●													1.2
TCP18R075F-005	R	0.75	0.05	●													2
TCP18L075F-005	L	0.75	0.05	●													2
TCP18R095F-005	R	0.95	0.05	●													2
TCP18L095F-005	L	0.95	0.05	●													2
TCP18R100F-005	R	1	0.05	●													2
TCP18R100F-010	R	1	0.1	●													2
TCP18L100F-010	L	1	0.1	●													2
TCP18R120F-005	R	1.2	0.05	●													2
TCP18R120F-010	R	1.2	0.1	●													2
TCP18L120F-010	L	1.2	0.1	●													2
TCP18R125F-005	R	1.25	0.05	●													2
TCP18R125F-010	R	1.25	0.1	●													2
TCP18L125F-010	L	1.25	0.1	●													2
TCP18R140F-010-35	R	1.4	0.1	●													3.5
TCP18R145F-005-35	R	1.45	0.05	●													3.5
TCP18R145F-010	R	1.45	0.1	●													2
TCP18L145F-010	L	1.45	0.1	●													2
TCP18R145F-010-35	R	1.45	0.1	●													3.5
TCP18L145F-010-35	L	1.45	0.1	●													3.5
TCP18R150F-005-35	R	1.5	0.05	●													3.5
TCP18R150F-010	R	1.5	0.1	●													2
TCP18L150F-010	L	1.5	0.1	●													2
TCP18R150F-010-35	R	1.5	0.1	●													3.5
TCP18L150F-010-35	L	1.5	0.1	●													3.5
TCP18R175F-005-35	R	1.75	0.05	●													3.5
TCP18R175F-010	R	1.75	0.1	●													2
TCP18L175F-010	L	1.75	0.1	●													2
TCP18R175F-010-35	R	1.75	0.1	●													3.5
TCP18L175F-010-35	L	1.75	0.1	●													3.5
TCP18R200F-005-35	R	2	0.05	●													3.5
TCP18R200F-010	R	2	0.1	●													2.5
TCP18L200F-010	L	2	0.1	●													2.5
TCP18R200F-010-35	R	2	0.1	●													3.5
TCP18L200F-010-35	L	2	0.1	●													3.5
TCP18R250F-010	R	2.5	0.1	●													2.5
TCP18L250F-010	L	2.5	0.1	●													2.5
TCP18R250F-010-35	R	2.5	0.1	●													3.5
TCP18L250F-010-35	L	2.5	0.1	●													3.5
TCP18R300F-010	R	3	0.1	●													2.5
TCP18L300F-010	L	3	0.1	●													2.5
TCP18R300F-010-35	R	3	0.1	●													3.5
TCP18L300F-010-35	L	3	0.1	●													3.5

5 pieces per package
● : Line up

Reference pages: Toolholders → **F044 - F050**, Standard cutting conditions → **F058**

STANDARD CUTTING CONDITIONS

TCS18R/L, TCL18R/L (3D chipbreaker), TCG18R/L (honed edge), TCG18R/L (Full R)

ISO	Workpiece materials	Grade	Cutting speed Vc (m/min)	Feed: f (mm/rev)		
				TCL18	TCS18	TCG18
P	Low carbon steel S15C, SS400, etc., C15E4, E275A, etc.	AH7025	80 - 180	0.03 - 0.12	0.04 - 0.16	0.04 - 0.14
	Carbon steel, Alloy steel S55C, SCM440, etc., C55, 42CrMo4, etc.	AH7025	80 - 180	0.03 - 0.12	0.04 - 0.16	0.04 - 0.14
	Prehardened steel NAK80, PX5, etc.	AH7025	80 - 180	0.03 - 0.12	0.04 - 0.16	0.04 - 0.14
M	Stainless steel SUS304, SUS316, etc., X5CrNi18-9, X5CrNiMo17-12-3, etc.	AH7025	50 - 120	0.03 - 0.12	0.04 - 0.16	0.04 - 0.14
K	Grey cast iron FC250, FC300, etc., 250, 300, etc., GG25, GG30, etc.	AH7025	50 - 180	0.03 - 0.12	0.04 - 0.16	0.04 - 0.14
	Ductile cast iron FCD400, etc., 400-15S, etc., GGG40, etc.	AH7025	50 - 180	0.03 - 0.12	0.04 - 0.16	0.04 - 0.14
S	Titanium alloys Ti-6Al-4V, etc.	AH7025	30 - 60	0.03 - 0.12	0.04 - 0.16	0.04 - 0.14
	Superalloys Inconel718, etc.	AH7025	20 - 40	0.03 - 0.12	0.04 - 0.16	0.04 - 0.14



TCP18R/L (lightly honed edge), TCP18R/L-F (sharp edge)

ISO	Workpiece materials	Priority	Grades	Cutting speed Vc (m/min)	Feed f (mm/rev)
P	Low carbon steel S15C, SS400, etc., C15E4, E275A, etc.	First choice	SH725	80 - 180	0.03 - 0.1
		Toughness	AH725	80 - 180	0.03 - 0.1
	Carbon steel, Alloy steel S55C, SCM440, etc., C55, 42CrMo4, etc.	First choice	SH725	80 - 180	0.03 - 0.1
		Toughness	AH725	80 - 180	0.03 - 0.1
M	Stainless steel SUS304, SUS316, etc., X5CrNi18-9, X5CrNiMo17-12-3, etc.	First choice	SH725	50 - 120	0.03 - 0.1
		Toughness	AH725	50 - 120	0.03 - 0.1
	Grey cast iron FC250, FC300, etc., 250, 300, etc., GG25, GG30, etc.	First choice	AH725	50 - 180	0.03 - 0.1
		Sharpness	SH725	50 - 180	0.03 - 0.1
K	Ductile cast iron FCD400, etc., 400-15S, etc., GGG40, etc.	First choice	AH725	50 - 180	0.03 - 0.1
		Sharpness	SH725	50 - 180	0.03 - 0.1
	Titanium alloys Ti-6Al-4V, etc.	First choice	SH725	30 - 80	0.03 - 0.1
		Toughness	AH725	30 - 80	0.03 - 0.1
S	Superalloys Inconel718, etc.	First choice	AH725	20 - 40	0.03 - 0.1

Precautions of processing

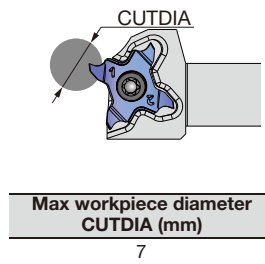
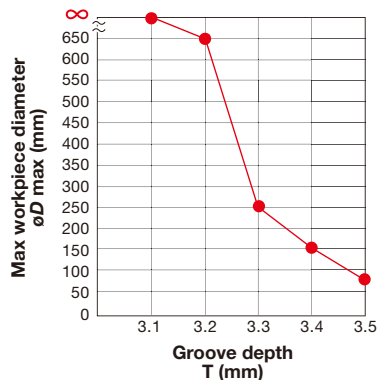
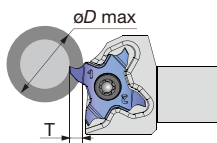

*Groove depth and max workpiece diameter (øDmax)

Maximum workpiece diameter is limited relative to depth of cut in order to avoid collision between insert and workpiece.

External toolholders for grooving, parting

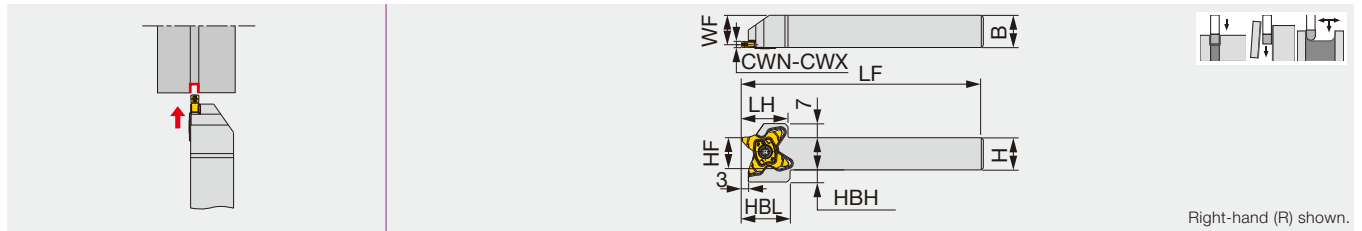

Designation	CWN	CWX	H	B	LF	LH	HBL	HF	WF	HBH	Insert	Torque*
STCR/L1010-27	0.5	3.18	10	10	120	23	24	10	8.5	9.5	TC*27...	2.5
STCR/L1212-27	0.5	3.18	12	12	120	23	24	12	10.5	8	TC*27...	2.5
STCR/L1616-27	0.5	3.18	16	16	120	23	24	16	14.5	6	TC*27...	2.5
STCR/L2020-27	0.5	3.18	20	20	120	23	24	20	18.5	2	TC*27...	2.5
STCR/L2525-27	0.5	3.18	25	25	135	23	-	25	23.5	-	TC*27...	2.5

*Torque: Recommended clamping torque: N-m

STCR/L-27-CHP

Direct connection

Grooving and parting-off toolholder. High pressure coolant capability.

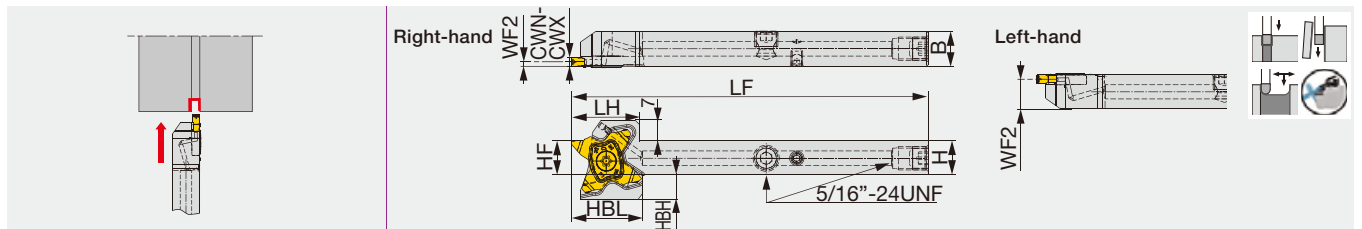

Designation	CWN	CWX	H	B	LF	LH	HF	WF2 ⁽¹⁾	HBH	HBL	Insert	Torque*
STCR/L1212-27-CHP	0.5	3.18	12	12	120	23	12	1.5/10.5	8	24	TC*27...	2.5

- Make sure to avoid tool interferences when used on Swiss machines
 (1) The above WF2 value is valid when an insert width of CW=3 is mounted.
 *Torque: Recommended torque (N-m) for clamping

SPARE PARTS

Designation	Screw	Wrench	Coolant plug	Wrench	DirectJet plug	Wrench
STCR** -27	SR16-212-01397L	T-2010/5	-	-	-	-
STCL** -27	SR16-212-01397	T-2010/5	-	-	-	-
STCR1212-27-CHP	SR16-212-01397L	T-2010/5	SR5/16UNFTL360	P-4	SSHM4-6-TB	P-2
STCL1212-27-CHP	SR16-212-01397	T-2010/5	SR5/16UNFTL360	P-4	SSHM4-6-TB	P-2

External grooving and parting toolholder, with high pressure coolant capability

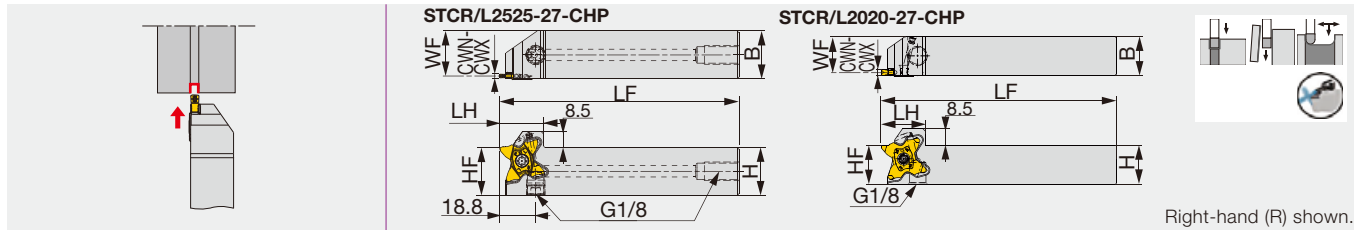

Designation	CWN	CWX	H	B	LF	LH	HF	WF	Insert	Torque*
STCR/L2020-27-CHP	0.5	3.18	20	20	120	23	20	18.5	TC*27...	2.5
STCR/L2525-27-CHP	0.5	3.18	25	25	125	23	25	23.5	TC*27...	2.5

*Torque: Recommended torque (N·m) for clamping



STCAR/L27-CHP

External grooving and parting adapter, with high pressure coolant capability

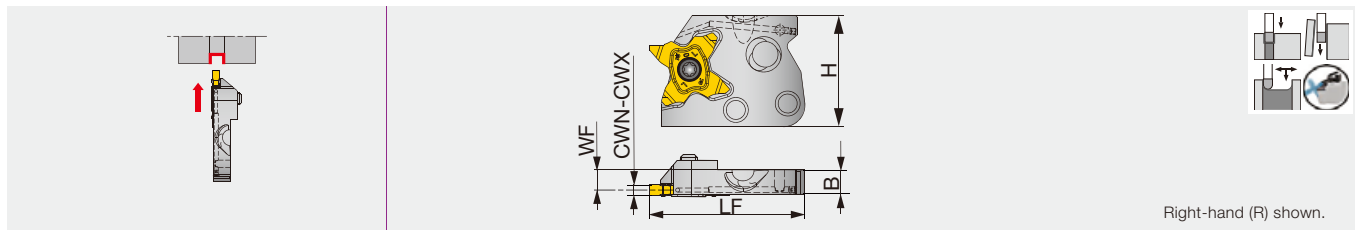

Designation	CWN	CWX	WF	H	LF	B	Insert	Torque*
STCAR/L27-CHP	0.5	3.18	6	33	46	7.2	TC*27...	2.5

*Torque: Recommended torque (N·m) for clamping



SPARE PARTS



Designation	Screw	Wrench
STCR*-27-CHP	SR16-212-01397L	T-2010/5
STCL*-27-CHP	SR16-212-01397	T-2010/5
STCAR27-CHP	SR16-212-01397L	T-2010/5
STCAL27-CHP	SR16-212-01397	T-2010/5

Reference pages: STCR/L-27-CHP: Inserts → **F065 - F069**, Standard cutting conditions → **F070**

Parts for coolant hose → **F266**

STCAR/L27-CHP: Inserts → **F065 - F069**, Shanks and toolholders → **F061 - F063**

Standard cutting conditions → **F070**, Technical Reference → **L053**

CHSR/L-CHP

Tube connection

Shank for adapter, with high pressure coolant capability

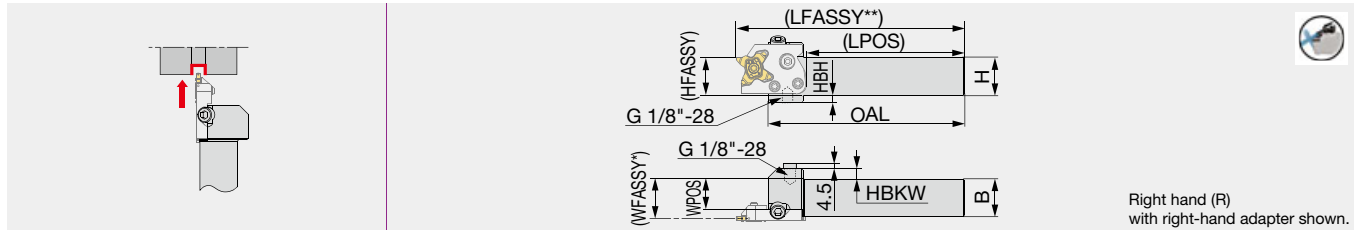

Right hand (R)
with right-hand adapter shown.

Designation	H	B	OAL	LPOS	WPOS	HBKW	HFASSY	HBH	Adapter (Option)	Torque*
CHSR/L2020-CHP	20	20	130	105.5	15.1	12	20	10	STCAR/L27-CHP	6.5
CHSR/L2525-CHP	25	25	130	105.5	20.1	7	25	5	STCAR/L27-CHP	6.5

WFASSY* : Shank (WPOS) + adapter (WF)

LFASSY** : Shank (LPOS) + adapter (LF)

Depend on the adapter type, the value of LFASSY or WFASSY may change.

Torque*: Recommended clamping torque (N·m)

Applicable for 30 MPa coolant

Please see page L053 for instructions on installing and removing the adapter or the insert.

CHSR/L-CHP-MC

Direct connection

Shank for adapter, with high pressure coolant capability

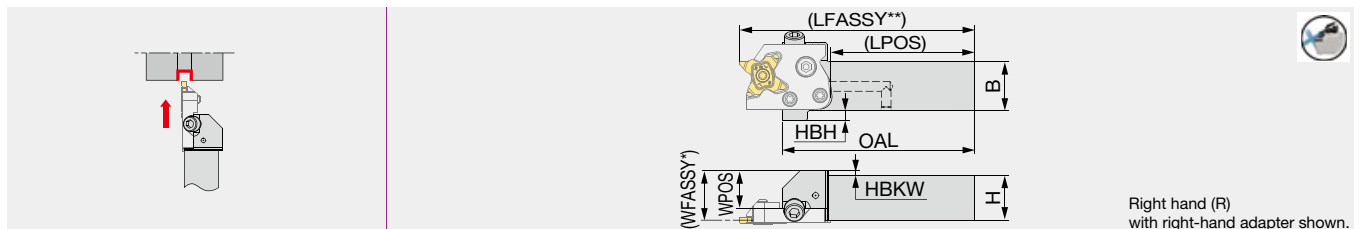

Right hand (R)
with right-hand adapter shown.

Designation	H	B	OAL	LPOS	WPOS	HBKW	HBH	Adapter (Option)	Torque*
CHSR/L2020-CHP-MC	20	20	98	73.5	14	6	10	STCAR/L27-CHP	6.5
CHSR/L2525-CHP-MC	25	25	98	73.5	19	-	5	STCAR/L27-CHP	6.5

WFASSY* : Shank (WPOS) + adapter (WF)

LFASSY** : Shank (LPOS) + adapter (LF)

Depend on the adapter type, the value of LFASSY or WFASSY may change.

Torque*: Recommended clamping torque (N·m)

Applicable for 30 MPa coolant

Please see page L053 for instructions on installing and removing the adapter or the insert.

SPARE PARTS

Designation	Clamping screw 1	Wrench 1	Clamping screw 2	Clamping screw 3	Wrench 2	O-ring	Plug
CHSR/L*-CHP	SR M5-04451	T-20/5	SR M6X12DIN6912	SR M6X20-XT	HW5.0	OR 5X1N	PLUGG1/8ISO1179
CHSR/L*-CHP-MC	SR M5-04451	T-20/5	SR M6X12DIN6912	SR M6X20-XT	HW5.0	OR 5X1N	-

Recommended clamping torque (N·m)

Clamping screw	Torque (N·m)
SR M5-04451	5
SR M6X12DIN6912	8.5
SR M6X20-XT	8.5

Combination of adapter and shank

Shank	Adapter	
	STCAR27-CHP	STCAL27-CHP
CHSR**-CHP (-MC)	●	
CHSL**-CHP (-MC)		●
CHFVR**-CHP		●
CHFVL**-CHP	●	

● : Corresponding

Reference pages: Inserts → F065 - F069, Adapters → F060, Standard cutting conditions → F070
Parts for coolant hose → F266, Technical Reference → L053

Shank for perpendicularly-mounted adapter, with high pressure coolant capability

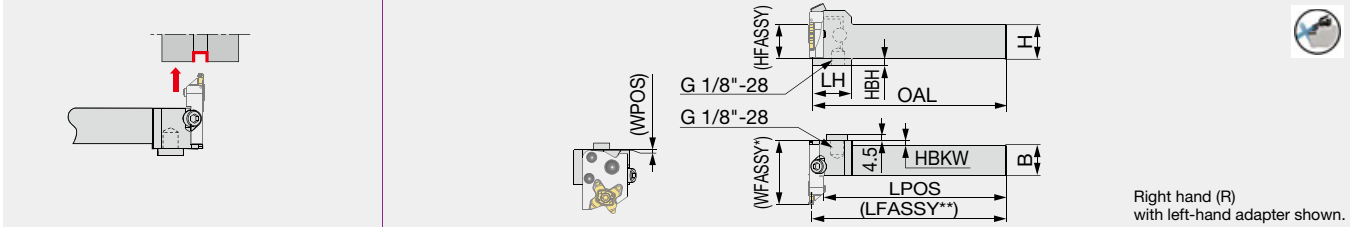

Right hand (R)
with left-hand adapter shown.

Designation	H	B	OAL	LH	LPOS	WPOS	HBKW	HFASSY	HBH	Adapter (Option)	Torque*
CHFVR/L2020-CHP	20	20	140	28	135.1	0.5	5	20	10	STCAL/R27-CHP	6.5
CHFVR/L2525-CHP	25	25	140	28	135.1	0.5	0	25	5	STCAL/R27-CHP	6.5

WFASSY* : Shank (WPOS) + adapter (LF)

LFASSY** : Shank (LPOS) + adapter (WF)

Depend on the adapter type, the value of LFASSY or WFASSY may change.

Torque*: Recommended clamping torque (N·m)

Applicable for 30 MPa coolant

Please see page L053 for instructions on installing and removing the adapter or the insert.

SPARE PARTS

Designation	Clamping screw 1	Wrench 1	Clamping screw 2	Clamping screw 3	Wrench 2	O-ring	Plug
CHFVR/L...	SR M5-04451	T-20/5	SR M6X12DIN6912	SR M6X20-XT	HW5.0	OR 5X1N	PLUGG1/8ISO1179

Recommended clamping torque (N·m)

Clamping screw	Torque (N·m)
SR M5-04451	2.5
SR M6X12DIN6912	6.5
SR M6X20-XT	6.5

Combination of adapter and shank

Shank	Adapter	
	STCAR27-CHP	STCAL27-CHP
CHSR**-CHP (-MC)	●	
CHSL**-CHP (-MC)		●
CHFVR**-CHP		●
CHFVL**-CHP	●	

● : Corresponding

C*CHSN-CHP

Direct connection

Toolholder with TungCap connection, for adapter, with high pressure coolant capability

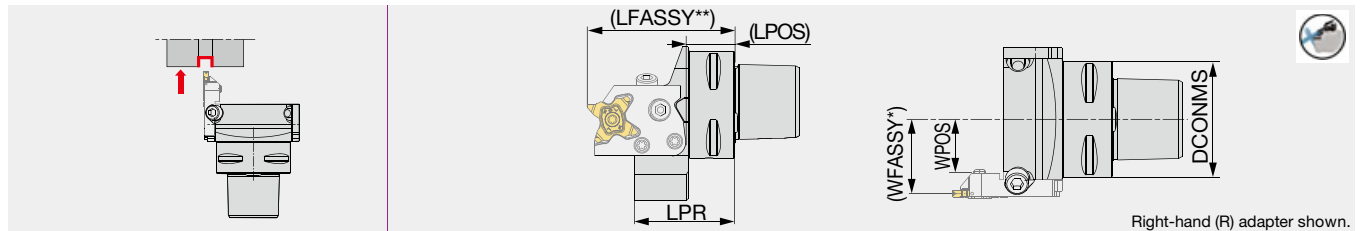

Right-hand (R) adapter shown.

Designation	DCONMS	LPR	LPOS	WPOS	Adapter (Option)	Torque*
C3CHSN19045-CHP	32	45	17.5	18.5	STCAR/L27-CHP	6.5
C4CHSN21047-CHP	40	46.5	21.5	21	STCAR/L27-CHP	6.5
C5CHSN26047-CHP	50	47	22.5	26	STCAR/L27-CHP	6.5
C6CHSN33050-CHP	63	50	24.5	32.5	STCAR/L27-CHP	6.5

WFASSY* : Toolholder (WPOS) + adapter (WF)

LFASSY** : Toolholder (LPOS) + adapter (LF)

Depend on the adapter type, the value of LFASSY or WFASSY may change.

Torque*: Recommended clamping torque (N·m)

Applicable for 30 MPa coolant

Please see page L053 for instructions on installing and removing the adapter or the insert.

C*CHFVN-CHP

Direct connection

Toolholder with TungCap connection, for perpendicularly-mounted adapter, with high pressure coolant capability

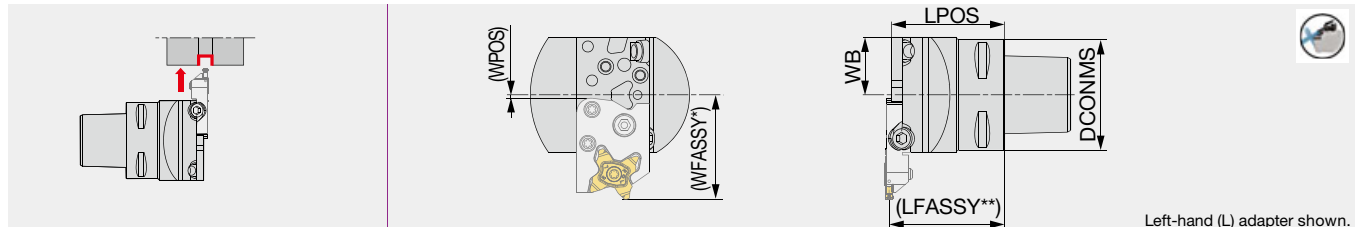

Left-hand (L) adapter shown.

Designation	DCONMS	LPOS	WB	WPOS	Adapter (Option)	Torque*
C3CHFVN26040-CHP	32	40	26	1.5	STCAR/L27-CHP	6.5
C4CHFVN26046-CHP	40	46	26	1.5	STCAR/L27-CHP	6.5
C5CHFVN26046-CHP	50	46	26	1.5	STCAR/L27-CHP	6.5
C6CHFVN33046-CHP	63	46	33	8.5	STCAR/L27-CHP	6.5

WFASSY* : Toolholder (WPOS) + adapter (LF)

LFASSY** : Toolholder (LPOS) + adapter (WF)

Depend on the adapter type, the value of LFASSY or WFASSY may change.

Torque*: Recommended clamping torque (N·m)

Applicable for 30 MPa coolant

Please see page L053 for instructions on installing and removing the adapter or the insert.

SPARE PARTS

Designation	Clamping screw 1	Wrench 1	Clamping screw 2	Clamping screw 3	Wrench 2	O-ring
C*CH**N*-CHP	SR M5-04451	T-20/5	SR M6X12DIN6912	SR M6X20-XT	HW5.0	OR 5X1N

Recommended clamping torque (N·m)

Clamping screw	Torque (N·m)
SR M5-04451	2.5
SR M6X12DIN6912	6.5
SR M6X20-XT	6.5

Reference pages: Inserts → F065 - F069, Adapters → F060, Standard cutting conditions → F070
 Technical Reference → L053

External grooving toolholder, with high pressure coolant capability

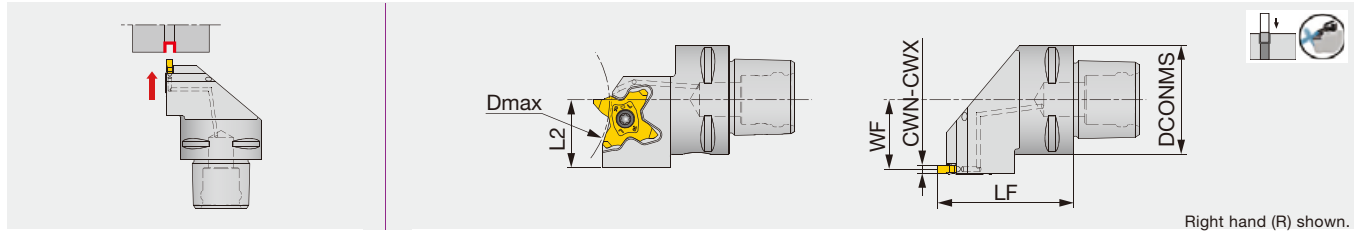

Right hand (R) shown.

Designation	CWN	CWX	DCONMS	LF	L2	WF	Dmax	Insert	Torque*
C4STCR/L27050-27-CHP	0.5	3.18	40	50	25	25.5	68 ⁽¹⁾	TC*27R/L...	2.5

Applicable for 14 MPa coolant

(1) The value for 6.4 mm groove depth. *Dmax* varies according to the grooving depth required.

*Torque: Recommended clamping torque (N·m)



STCR/L-38

External grooving and parting toolholder

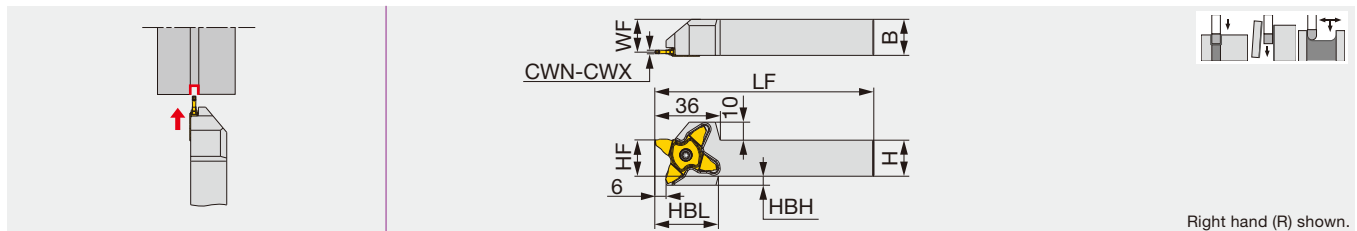

Right hand (R) shown.

Designation	CWN	CWX	H	B	LF	HF	WF	HBH	HBL	Insert	Torque*
STCR/L2020-38	1.5	4	20	20	120	20	18.1	5	35	TCL38...	2.5
STCR/L2525-38	1.5	4	25	25	135	25	23.1	-	-	TCL38...	2.5
STCR/L3232-38	1.5	4	32	32	135	32	30.1	-	-	TCL38...	2.5

*Torque: Recommended clamping torque (N·m)



STCR/L-38-CHP

Tube connection

External grooving and parting toolholder, with high pressure coolant capability

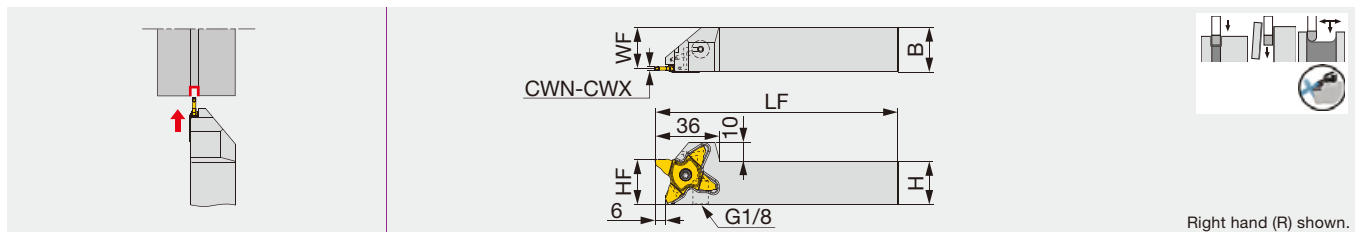

Right hand (R) shown.

Designation	CWN	CWX	H	B	LF	HF	WF	Insert	Torque*
STCR/L2525-38-CHP	1.5	4	25	25	135	25	23.1	TCL38...	2.5

*Torque: Recommended clamping torque (N·m)

SPARE PARTS







Designation	Screw	Wrench
C4STCR27050-27-CHP	SR16-212-01397L	T-2010/5
C4STCL27050-27-CHP	SR16-212-01397	T-2010/5
STCR...	SR16-212-01397L	T-2010/5
STCL...	SR16-212-01397	T-2010/5

Reference pages: Inserts → **F065 - F069**, Standard cutting conditions → **F070**
Parts for coolant hose → **F266**

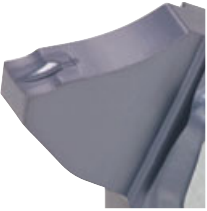
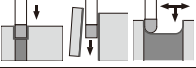
CHIPBREAKER GUIDE

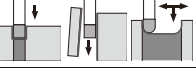
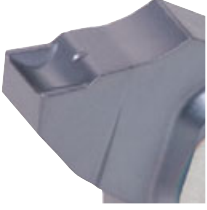
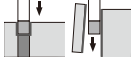
External grooving and parting

<p>TCS27 (4 corners)</p>  <p>F066, F067</p>	<p>First choice for grooving</p> <p>For general machining Lower cutting force and superior sharpness CW = 0.5 - 3.18 mm CDX = 6.4 mm</p> 	<p>TCM27 (4 corners)</p>  <p>F068, F069</p>	<p>For higher efficiency</p> <p>For high feed machining Well-designed edge with high strength and fracture resistance CW = 1.5 - 3.18 mm CDX = 6.4 mm</p> 
<p>TCL27 (4 corners)</p>  <p>F065</p>	<p>For lighter cutting action</p> <p>Extremely sharp cutting edge A large dimple geometry eliminates chip jamming CW = 1.5 - 3 mm CDX = 6.4 mm</p> 	<p>TCL38 (4 corners)</p>  <p>F069</p>	<p>For lighter cutting action</p> <p>Sharp edge for light cutting action Excellent chip control at low feeds CW = 1.5 - 4 mm CDX = 10 mm</p> 

Please see page F*** for the product details.

INSERTS

TCL27 (for grooving and parting off)

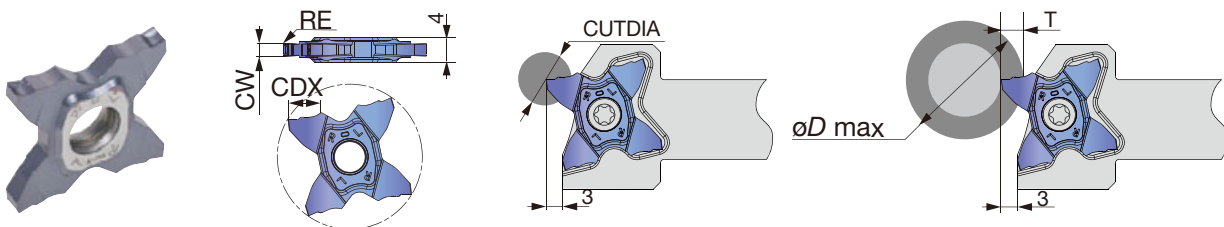

P	Steel	★		
M	Stainless	★		
K	Cast iron	★		
N	Non-ferrous			
S	Superalloys	★		
H	Hard materials			

★ : First choice

Designation	CW±0.02	RE	Coated		CDX	CUTDIA	Relation of groove depth (T) and Max. diameter (øD max)									
			AH725				T ≤ 3	T ≤ 3.5	T ≤ 4	T ≤ 4.5	T ≤ 5	T ≤ 5.5	T ≤ 5.7	T ≤ 6	T ≤ 6.2	T ≤ 6.4
TCL27-150-015	1.5	0.15	●		5.7	11.4	∞	600	280	180	130	50	35	-	-	-
TCL27-200-020	2	0.2	●		6.4	12.8	∞	600	280	180	130	105	85	60	50	30
TCL27-250-020	2.5	0.2	●		6.4	12.8	∞	600	280	180	130	105	85	60	50	30
TCL27-300-020	3	0.2	●		6.4	12.8	∞	600	280	180	135	105	95	85	78	55

5 pieces per package

● : Line up

Reference pages: Toolholders → F059 - F064, Standard cutting conditions → F070



TCS27 (for grooving and parting off)

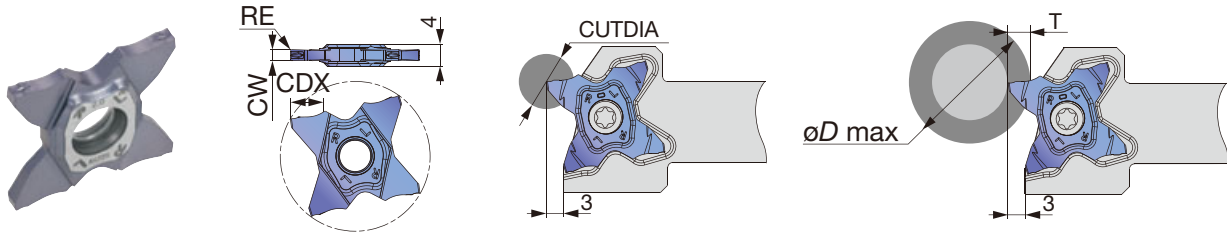

P	Steel	★	
M	Stainless	★	
K	Cast iron	★	
N	Non-ferrous		
S	Superalloys	★	
H	Hard materials		

★ : First choice



Designation	CW±0.02	RE	Coated		CDX	CUTDIA	Relation of groove depth (T) and Max. diameter (øD max)												
			AH725				T≤3	T≤3.5	T≤4	T≤4.5	T≤5	T≤5.5	T≤5.7	T≤6	T≤6.2	T≤6.4			
TCS27-050-000	0.5	0	●		1	2	∞	-	-	-	-	-	-	-	-	-	-		
TCS27-050-004	0.5	0.04	●		2.5	5	∞	-	-	-	-	-	-	-	-	-	-		
TCS27-075-010	0.75	0.1	●		2.5	5	∞	-	-	-	-	-	-	-	-	-	-		
TCS27-080-000	0.8	0	●		1.6	3.2	∞	-	-	-	-	-	-	-	-	-	-		
TCS27-100-006	1	0.06	●		3.5	7	∞	600	-	-	-	-	-	-	-	-	-		
TCS27-100-010	1	0.1	●		3.5	7	∞	600	-	-	-	-	-	-	-	-	-		
TCS27-104-000	1.04	0	●		2	4	∞	-	-	-	-	-	-	-	-	-	-		
TCS27-120-000	1.2	0	●		2	4	∞	-	-	-	-	-	-	-	-	-	-		
TCS27-125-010	1.25	0.1	●		3.5	7	∞	600	-	-	-	-	-	-	-	-	-		
TCS27-125-020	1.25	0.2	●		3.5	7	∞	600	-	-	-	-	-	-	-	-	-		
TCS27-140-000	1.4	0	●		2	4	∞	-	-	-	-	-	-	-	-	-	-		
TCS27-147-000	1.47	0	●		2.5	5	∞	-	-	-	-	-	-	-	-	-	-		
TCS27-150-010	1.5	0.1	●		5.7	11.4	∞	600	280	180	130	50	35	-	-	-	-		
TCS27-150-020	1.5	0.2	●		5.7	11.4	∞	600	280	180	130	50	35	-	-	-	-		
TCS27-157-015	1.57	0.15	●		3	6	∞	-	-	-	-	-	-	-	-	-	-		
TCS27-170-010	1.7	0.1	●		3	6	∞	-	-	-	-	-	-	-	-	-	-		
TCS27-175-010	1.75	0.1	●		3	6	∞	-	-	-	-	-	-	-	-	-	-		
TCS27-175-020	1.75	0.2	●		3	6	∞	-	-	-	-	-	-	-	-	-	-		
TCS27-178-018	1.78	0.18	●		3	6	∞	-	-	-	-	-	-	-	-	-	-		
TCS27-185-020	1.85	0.2	●		3	6	∞	-	-	-	-	-	-	-	-	-	-		
TCS27-196-015	1.96	0.15	●		3	6	∞	-	-	-	-	-	-	-	-	-	-		
TCS27-200-010	2	0.1	●		6.4	12.8	∞	600	280	180	130	105	85	60	50	30			
TCS27-200-020	2	0.2	●		6.4	12.8	∞	600	280	180	130	105	85	60	50	30			
TCS27-222-015	2.22	0.15	●		3.5	7	∞	600	-	-	-	-	-	-	-	-	-		
TCS27-230-020	2.3	0.2	●		3.5	7	∞	600	-	-	-	-	-	-	-	-	-		
TCS27-239-015	2.39	0.15	●		5.7	11.4	∞	600	280	180	130	50	35	-	-	-	-		
TCS27-247-020	2.47	0.2	●		5.7	11.4	∞	600	280	180	130	50	35	-	-	-	-		
TCS27-250-010	2.5	0.1	●		5.7	11.4	∞	600	280	180	130	50	35	-	-	-	-		
TCS27-250-030	2.5	0.3	●		5.7	11.4	∞	600	280	180	130	50	35	-	-	-	-		
TCS27-270-010	2.7	0.1	●		6.2	12.4	∞	600	280	180	135	105	95	85	78	-	-		
TCS27-287-020	2.87	0.2	●		6.2	12.4	∞	600	280	180	135	105	95	85	78	-	-		
TCS27-300-000	3	0	●		6.4	12.8	∞	600	280	180	135	105	95	85	78	55			
TCS27-300-020	3	0.2	●		6.4	12.8	∞	600	280	180	135	105	95	85	78	55			
TCS27-300-030	3	0.3	●		6.4	12.8	∞	600	280	180	135	105	95	85	78	55			
TCS27-300-040	3	0.4	●		6.4	12.8	∞	600	280	180	135	105	95	85	78	55			
TCS27-315-015	3.15	0.15	●		6.4	12.8	∞	600	280	180	135	105	95	85	78	68			
TCS27-318-020	3.18	0.2	●		6.4	12.8	∞	600	280	180	135	105	95	85	78	68			

5 pieces per package

● : Line up

Reference pages: Toolholders → F059 - F064, Standard cutting conditions → F070

TCS27-R/L (for parting off)

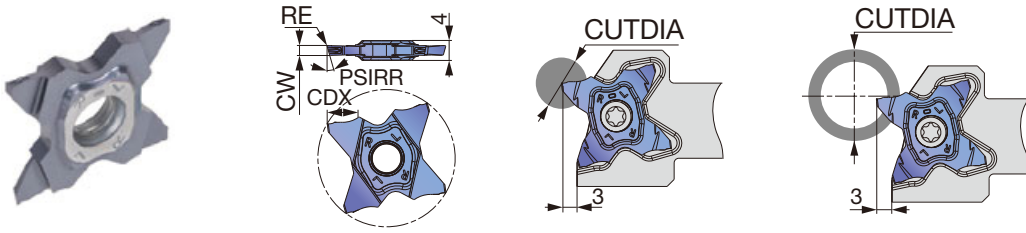

Right hand (R) shown.

P	Steel	★		
M	Stainless	★		
K	Cast iron	★		
N	Non-ferrous			
S	Superalloys	★		
H	Hard materials			

★ : First choice

Designation	HAND	CW±0.02	RE	Coated		CDX	PSIRL	PSIRR	Max. parting off dia. CUTDIA	
				AH725					Solid bar	Tube
TCS27-100-15R	R	1	0.06	●		3.5	0°	15°	7	600
TCS27-100-15L	L	1	0.06	●		3.5	15°	0°	7	600
TCS27-150-6R	R	1.5	0.06	●		5.7	0°	6°	11.4	35
TCS27-150-6L	L	1.5	0.06	●		5.7	6°	0°	11.4	35
TCS27-150-15R	R	1.5	0.06	●		5.7	0°	15°	11.4	35
TCS27-150-15L	L	1.5	0.06	●		5.7	15°	0°	11.4	35
TCS27-200-6R	R	2	0.1	●		6.4	0°	6°	12.8	30
TCS27-200-6L	L	2	0.1	●		6.4	6°	0°	12.8	30
TCS27-200-15R	R	2	0.1	●		6.4	0°	15°	12.8	30
TCS27-200-15L	L	2	0.1	●		6.4	15°	0°	12.8	30

5 pieces per package

● : Line up

TCS27 (for grooving and profiling, full R)

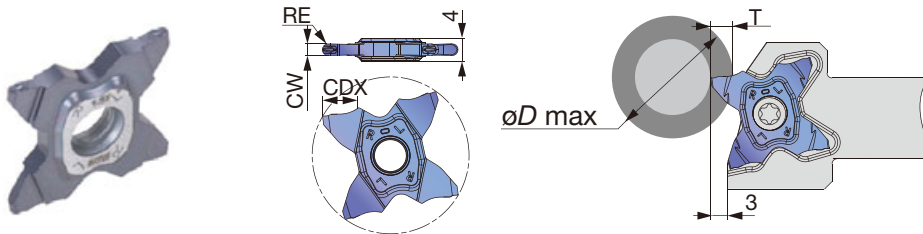

P	Steel	★		
M	Stainless	★		
K	Cast iron	★		
N	Non-ferrous			
S	Superalloys	★		
H	Hard materials			

★ : First choice

Designation	CW±0.02	RE	Coated		CDX	Relation of groove depth (T) and Max. diameter (øD max)										
			AH725			T≤3	T≤3.5	T≤4	T≤4.5	T≤5	T≤5.5	T≤5.7	T≤6	T≤6.2	T≤6.4	
TCS27-157-079	1.57	0.79	●		3	∞	-	-	-	-	-	-	-	-	-	-
TCS27-200-100	2	1	●		3	∞	-	-	-	-	-	-	-	-	-	-
TCS27-239-120	2.39	1.2	●		5.7	∞	600	280	180	130	50	35	-	-	-	-
TCS27-300-150	3	1.5	●		6.4	∞	600	280	180	135	105	95	85	78	55	-

5 pieces per package

● : Line up



TCM27 (for grooving and parting off)

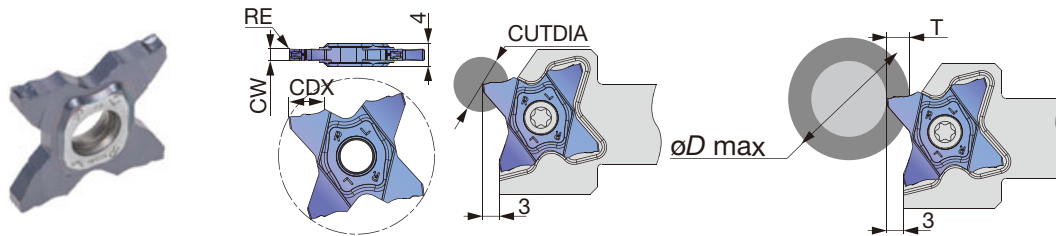

P	Steel	★		
M	Stainless	★		
K	Cast iron	★		
N	Non-ferrous			
S	Superalloys	★		
H	Hard materials			

★ : First choice



Designation	CW±0.02	RE	Coated		CDX	CUTDIA	Relation of groove depth (T) and Max. diameter (øD max)									
			AH725				T ≤ 3	T ≤ 3.5	T ≤ 4	T ≤ 4.5	T ≤ 5	T ≤ 5.5	T ≤ 5.7	T ≤ 6	T ≤ 6.2	T ≤ 6.4
TCM27-150-010	1.5	0.1	●		5.7	11.4	∞	600	280	180	130	50	35	-	-	-
TCM27-150-020	1.5	0.2	●		5.7	11.4	∞	600	280	180	130	50	35	-	-	-
TCM27-157-015	1.57	0.15	●		3	6	∞	-	-	-	-	-	-	-	-	-
TCM27-170-010	1.7	0.1	●		3	6	∞	-	-	-	-	-	-	-	-	-
TCM27-175-010	1.75	0.1	●		3	6	∞	-	-	-	-	-	-	-	-	-
TCM27-175-020	1.75	0.2	●		3	6	∞	-	-	-	-	-	-	-	-	-
TCM27-178-018	1.78	0.18	●		3	6	∞	-	-	-	-	-	-	-	-	-
TCM27-185-020	1.85	0.2	●		3	6	∞	-	-	-	-	-	-	-	-	-
TCM27-196-015	1.96	0.15	●		3	6	∞	-	-	-	-	-	-	-	-	-
TCM27-200-010	2	0.1	●		6.4	12.8	∞	600	280	180	130	105	85	60	50	30
TCM27-200-020	2	0.2	●		6.4	12.8	∞	600	280	180	130	105	85	60	50	30
TCM27-222-015	2.22	0.15	●		3.5	7	∞	600	-	-	-	-	-	-	-	-
TCM27-230-020	2.3	0.2	●		3.5	7	∞	600	-	-	-	-	-	-	-	-
TCM27-239-015	2.39	0.15	●		5.7	11.4	∞	600	280	180	130	50	35	-	-	-
TCM27-247-020	2.47	0.2	●		5.7	11.4	∞	600	280	180	130	50	35	-	-	-
TCM27-250-010	2.5	0.1	●		5.7	11.4	∞	600	280	180	130	50	35	-	-	-
TCM27-250-030	2.5	0.3	●		5.7	11.4	∞	600	280	180	130	50	35	-	-	-
TCM27-270-010	2.7	0.1	●		6.2	12.4	∞	600	280	180	135	105	95	85	78	-
TCM27-287-020	2.87	0.2	●		6.2	12.4	∞	600	280	180	135	105	95	85	78	-
TCM27-300-000	3	0	●		6.4	12.8	∞	600	280	180	135	105	95	85	78	55
TCM27-300-020	3	0.2	●		6.4	12.8	∞	600	280	180	135	105	95	85	78	55
TCM27-300-030	3	0.3	●		6.4	12.8	∞	600	280	180	135	105	95	85	78	55
TCM27-300-040	3	0.4	●		6.4	12.8	∞	600	280	180	135	105	95	85	78	55
TCM27-315-015	3.15	0.15	●		6.4	12.8	∞	600	280	180	135	105	95	85	78	68
TCM27-318-020	3.18	0.2	●		6.4	12.8	∞	600	280	180	135	105	95	85	78	68

5 pieces per package

● : Line up

Reference pages: Toolholders → **F059 - F064**, Standard cutting conditions → **F070**

TCM27 (for grooving and profiling, full R)

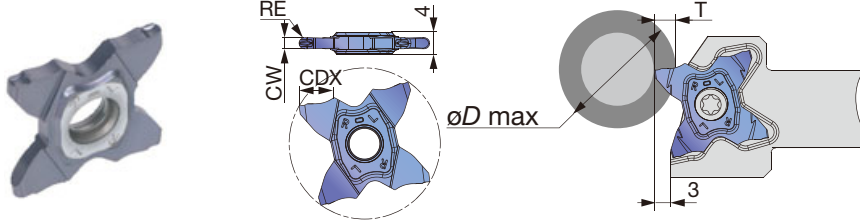

P	Steel	★		
M	Stainless	★		
K	Cast iron	★		
N	Non-ferrous			
S	Superalloys	★		
H	Hard materials			

★ : First choice

Designation	CW±0.02	RE	Coated		CDX	CUTDIA	Relation of groove depth (T) and Max. diameter (øD max)									
			AH725				T ≤ 3	T ≤ 3.5	T ≤ 4	T ≤ 4.5	T ≤ 5	T ≤ 5.5	T ≤ 5.7	T ≤ 6	T ≤ 6.2	T ≤ 6.4
							TCM27-157-079	1.57	0.79	●		3	6	∞	-	-
TCM27-200-100	2	1	●		3	6	∞	-	-	-	-	-	-	-	-	-
TCM27-239-120	2.39	1.2	●		5.7	11.4	∞	600	280	180	130	50	35	-	-	-
TCM27-300-150	3	1.5	●		6.4	12.8	∞	600	280	180	135	105	95	85	78	55

5 pieces per package

● : Line up

TCL38 (for grooving and parting off)

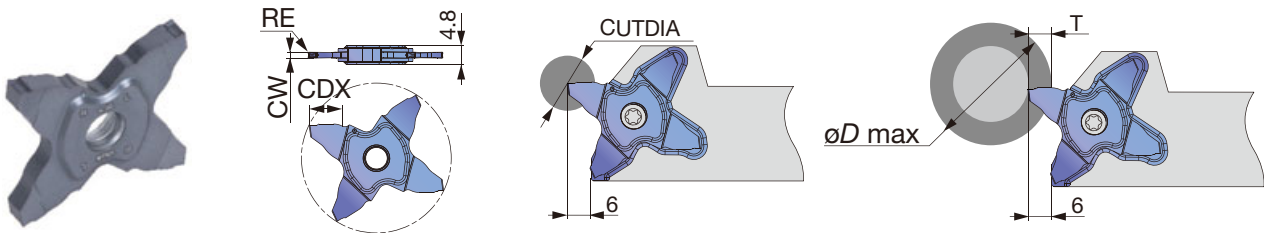

P	Steel	★		
M	Stainless	★		
K	Cast iron	★		
N	Non-ferrous			
S	Superalloys	★		
H	Hard materials			

★ : First choice

Designation	CW±0.02	RE	Coated		CDX	CUTDIA	Relation of groove depth (T) and Max. diameter (øD max)					
			AH7025				T ≤ 5	T ≤ 6	T ≤ 7	T ≤ 8	T ≤ 9	T ≤ 10
							TCL38-150-020	1.5	0.2	●		9
TCL38-200-020	2	0.2	●		9	18	∞	950	315	190	45	-
TCL38-300-020	3	0.2	●		10	20	∞	950	315	190	130	50
TCL38-400-030	4	0.3	●		10	20	∞	950	315	190	130	50

5 pieces per package

● : Line up



STANDARD CUTTING CONDITIONS

TCL27, TCS27, TCM27

ISO	Workpiece materials	Grades	Cutting speed Vc (m/min)	Feed: <i>f</i> (mm/rev)						Depth of cut for profiling (with full radius insert)	
				Grooving, Parting-off			Parting-off (with hand)		Profiling (with full radius insert)		
				TCL27	TCS27	TCM27	TCS27	TCS27	TCM27		
P	Carbon steel (S45C / C45, etc.)	AH725	100 - 200	0.03 - 0.12	0.05 - 0.15	0.05 - 0.25	0.04 - 0.12	0.05 - 0.1	0.05 - 0.15	0.5	
	Alloy steel (SCM435 / 34CrMo4, etc.)	AH725	50 - 180	0.03 - 0.12	0.05 - 0.15	0.05 - 0.25	0.04 - 0.12	0.05 - 0.1	0.05 - 0.15	0.5	
M	Stainless steel (SUS304 / X5CrNi18-9, etc.)	AH725	100 - 150	0.03 - 0.12	0.05 - 0.15	0.05 - 0.2	0.04 - 0.12	0.05 - 0.1	0.05 - 0.15	0.5	
K	Grey cast iron (FC250 / 250 / GG25, etc.)	AH725	50 - 180	0.03 - 0.12	0.05 - 0.15	0.05 - 0.25	0.04 - 0.12	0.05 - 0.1	0.05 - 0.15	0.5	
	Ductile cast iron (FCD400 / 400-15 / GGG400, etc.)	AH725	50 - 120	0.03 - 0.12	0.05 - 0.15	0.05 - 0.2	0.04 - 0.12	0.05 - 0.1	0.05 - 0.15	0.5	
S	Titanium alloys (Ti-6Al-4V, etc.)	AH725	30 - 60	0.03 - 0.12	0.05 - 0.15	0.05 - 0.15	0.04 - 0.12	0.05 - 0.1	0.05 - 0.1	0.5	
	Superalloys (Inconel718, etc.)	AH725	20 - 50	0.03 - 0.12	0.05 - 0.15	0.05 - 0.15	0.04 - 0.12	0.05 - 0.1	0.05 - 0.1	0.5	



TCL38

ISO	Workpiece materials	Grades	Cutting speed Vc (m/min)	Feed: <i>f</i> (mm/rev)
				Grooving, Parting-off
				TCL38
P	Carbon steel (S45C / C45, etc.)	AH7025	80 - 180	0.03 - 0.18
	Alloy steel (SCM435 / 34CrMo4, etc.)	AH7025	50 - 180	0.03 - 0.18
M	Alloy steel (SCM435 / 34CrMo4, etc.)	AH7025	50 - 150	0.03 - 0.14
K	Grey cast iron (FC250 / 250 / GG25, etc.)	AH7025	50 - 180	0.03 - 0.14
	Ductile cast iron (FCD400 / 400-15 / GGG400, etc.)	AH7025	50 - 120	0.03 - 0.14
S	Titanium alloys (Ti-6Al-4V, etc.)	AH7025	30 - 60	0.03 - 0.14
	Superalloys (Inconel718, etc.)	AH7025	20 - 50	0.03 - 0.14



Parting-off and grooving toolholders

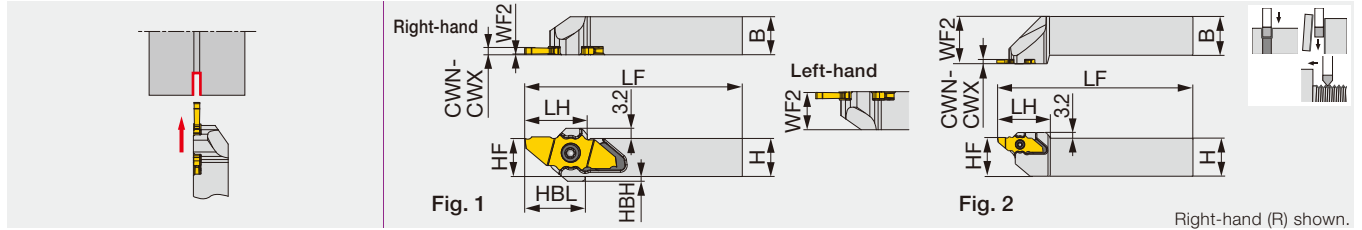

Designation	CWN	CWX	H	B	LF ⁽¹⁾	LH ⁽¹⁾	HF	WF2 ⁽²⁾	HBL ⁽¹⁾	HBH	Insert	Torque*	Fig.
JSXXR/L1010X09	0.6	2.5	10	10	120	19.65	10	0.2/9.8	19	3	JX**06...,12...,16..., 20...	1.2	1
JSXXR/L1212F09	0.6	2.5	12	12	85	19.65	12	0.2/11.8	19	1.5	JX**06...,12...,16..., 20...	1.2	1
JSXXR/L1212X09	0.6	2.5	12	12	120	19.65	12	0.2/11.8	19	1.5	JX**06...,12...,16..., 20...	1.2	1
JSXXR/L1616X09	0.6	2.5	16	16	120	19.65	16	0.2/15.8	-	-	JX**06...,12...,16..., 20...	1.2	1
JSXXR/L2020H09	0.6	2.5	20	20	100	22.5	20	0.2/19.8	-	-	JX**06...,12...,16..., 20...	1.2	1
JSXXR/L2525Z09	0.6	2.5	25	25	135	34	25	30	-	-	JX**06...,12...,16..., 20...	1.2	2

*Torque: Recommended clamping torque (N·m)
 (1) LF (Functional Length) LH (Head Length), and HBL (Head-bottom Offset Length) values shown above are true with JX**16... insert. LF, LH, and HBL will all be 2 mm shorter than the above values with JX**12... and JX**20... inserts, and 4 mm shorter for JX**06... insert.
 (2) The first value before "/" indicates the WF2 for the right-hand holder and the second value after "/" for the left-hand holder.
 Note: Use the right-hand insert (JX***R...) for a right-hand holder (JSXXR...); the left-hand insert (JX***L...) for a left-hand holder (JSXXL...).

JSXXR/L-F/H/X-CHP

Parting-off toolholders with high pressure coolant capability, for swiss lathes

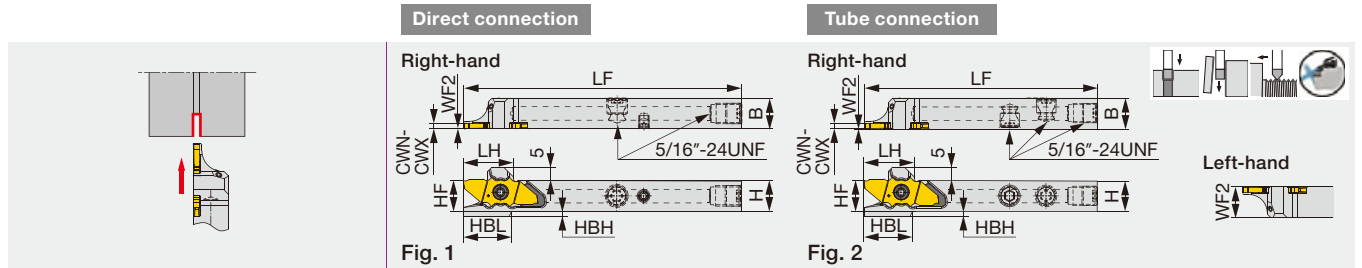

Designation	CWN	CWX	H	B	LF ⁽¹⁾	LH ⁽¹⁾	HF	WF2 ⁽²⁾	HBL ⁽¹⁾	HBH	Insert	Torque*	Fig.
JSXXR/L1012H09-CHP ⁽³⁾	0.6	2.5	10	12	102	19.2	10	0.2/11.8	18.7	3	JX**06...,12...,16..., 20...	1.2	1
JSXXR/L1212F09-CHP	0.6	2.5	12	12	85	19.4	12	0.2/11.8	18.8	2	JX**06...,12...,16..., 20...	1.2	2
JSXXR/L1212X09-CHP ⁽³⁾	0.6	2.5	12	12	120	19.4	12	0.2/11.8	18.8	2	JX**06...,12...,16..., 20...	1.2	1
JSXXR/L1616X09-CHP ^{(3),(4)}	0.6	2.5	16	16	120	19.4	16	0.2	18.7	2.5	JX**06...,12...,16..., 20...	1.2	1
JSXXR/L1616X09B-CHP ⁽³⁾	0.6	2.5	16	16	120	19.4	16	0.2/15.8	18.7	-	JX**06...,12...,16..., 20...	1.2	1

*Torque: Recommended clamping torque (N·m)
 (1) LF (Functional Length) LH (Head Length), and HBL (Head-bottom Offset Length) values shown above are true with JX**16... insert. LF, LH, and HBL will all be 2 mm shorter than the above values with JX**12... and JX**20... inserts, and 4 mm shorter for JX**06... insert.
 (2) The first value before "/" indicates the WF2 for the right-hand holder and the second value after "/" for the left-hand holder.
 (3) Compatible to the direct internal coolant supply system without the use of external coolant hose.
 (4) To be replaced with the new design
 Note: Use the right-hand insert (JX***R...) for a right-hand holder (JSXXR...); the left-hand insert (JX***L...) for a left-hand holder (JSXXL...).

SPARE PARTS

Designation	Clamping screw	Wrench 1	Coolant plug	Wrench 2	DirectJet plug	Wrench 3
JSXXR**09	CSTC-4L100DL	T-1008/5	-	-	-	-
JSXXL**09	CSTC-4L100DR	T-1008/5	-	-	-	-
JSXXR**F**-CHP	CSTC-4L100DL	T-1008/5	SR5/16UNFTL360	P-4	-	-
JSXXL**F**-CHP	CSTC-4L100DR	T-1008/5	SR5/16UNFTL360	P-4	-	-
JSXXR**H/X**-CHP	CSTC-4L100DL	T-1008/5	SR5/16UNFTL360	P-4	SSHM4-6-TB	P-2
JSXXL**H/X**-CHP	CSTC-4L100DR	T-1008/5	SR5/16UNFTL360	P-4	SSHM4-6-TB	P-2

Reference pages: Inserts → **F074, F075**, Standard cutting conditions → **F076**
 Parts for coolant hose → **F266**



Parting-off toolholders, for swiss lathes (for sub spindle)

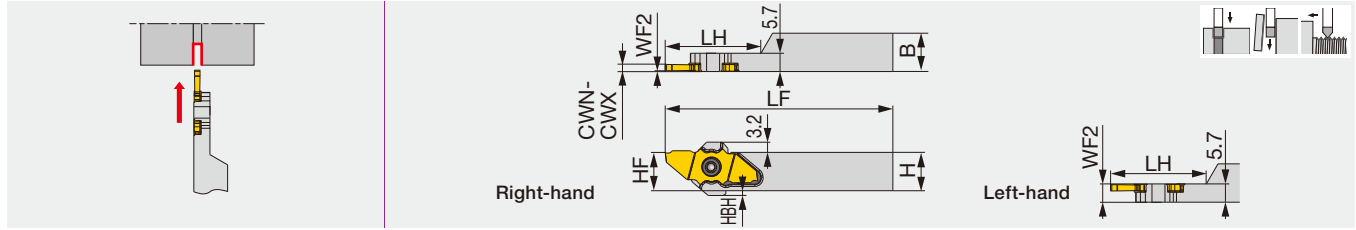

Designation	CWN	CWX	H	B	LF ⁽¹⁾	LH ⁽¹⁾	HF	WF2 ⁽²⁾	HBH	Insert	Torque*
JSXXR/L1010X09-S	0.6	2.5	10	10	120	26	10	0.2/5.5	3	JX**06...,12...,16... ⁽³⁾	1.2
JSXXR/L1212F09-S	0.6	2.5	12	12	85	26	12	0.2/5.5	1.5	JX**06...,12...,16... ⁽³⁾	1.2
JSXXR/L1212X09-S	0.6	2.5	12	12	120	30	12	0.2/5.5	1.5	JX**06...,12...,16... ⁽³⁾	1.2
JSXXR/L1616X09-S	0.6	2.5	16	16	120	30	16	0.2/5.5	-	JX**06...,12...,16...,20...	1.2

*Torque: Recommended clamping torque (N-m)

(1) LF (Functional Length) and LH (Head Length) values shown above are true with JX**16... insert. Both LF and LH will be 2 mm shorter than the above value with JX**12... and JX**20... inserts; 4 mm shorter with JX**06... insert.

(2) The first value before "/" indicates the WF2 for the right-hand holder and the second value after "/" for the left-hand holder.

(3) JX**20... insert will not fit.

Note: Use the right-hand insert (JX****R...) for a right-hand holder (JSXXR...); the left-hand insert (JX****L...) for a left-hand holder (JSXXL...).



JSXXR/L-F/X-S-CHP

Parting-off toolholders with high pressure coolant capability, for swiss lathes (for sub spindle)

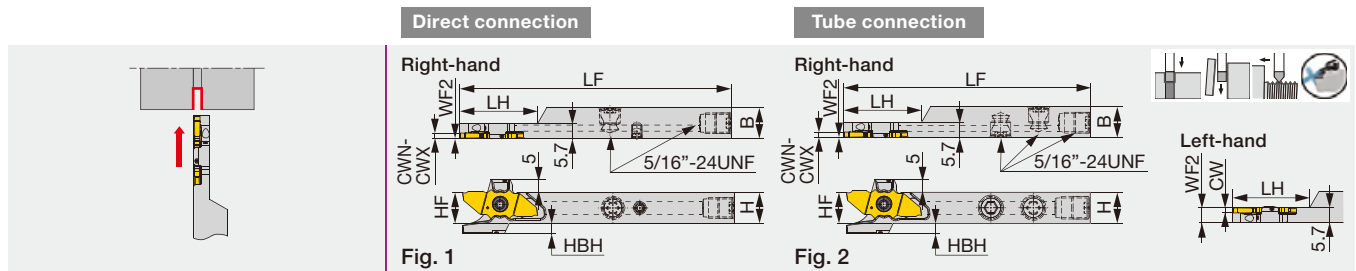

Designation	CWN	CWX	H	B	LF ⁽¹⁾	LH ⁽¹⁾	HF	WF2 ⁽²⁾	HBH	Insert	Torque*	Fig.
JSXXR1212F09-S-CHP ⁽⁴⁾	0.6	2.5	12	12	85	26	12	0.2	4	JX**06...,12...,16...,20...	1.2	2
JSXXR/L1212F09B-S-CHP	0.6	2.5	12	12	85	30	12	0.2/5.5	2	JX**06...,12...,16...,20...	1.2	2
JSXXR/L1212X09-S-CHP ^{(3),(4)}	0.6	2.5	12	12	120	30	12	0.2/5.5	4	JX**06...,12...,16...,20...	1.2	1
JSXXR/L1212X09B-S-CHP ⁽³⁾	0.6	2.5	12	12	120	30	12	0.2/5.5	2	JX**06...,12...,16...,20...	1.2	1
JSXXR1616X09-S-CHP ^{(3),(4)}	0.6	2.5	16	16	120	30	16	0.2	1.5	JX**06...,12...,16...,20...	1.2	1
JSXXR/L1616X09B-S-CHP ⁽³⁾	0.6	2.5	16	16	120	30	16	0.2/5.5	-	JX**06...,12...,16...,20...	1.2	1

*Torque: Recommended clamping torque (N-m)

(1) LF (Functional Length) and LH (Head Length) values shown above are true with JX**16... insert. Both LF and LH will be 2 mm shorter than the above value with JX**12... and JX**20... inserts; 4 mm shorter with JX**06... insert.

(2) The first value before "/" indicates the WF2 for the right-hand holder and the second value after "/" for the left-hand holder.

(3) Compatible to the direct internal coolant supply system without the use of external coolant hose.

(4) To be replaced with the new design

Note: Use the right-hand insert (JX****R...) for a right-hand holder (JSXXR...); the left-hand insert (JX****L...) for a left-hand holder (JSXXL...).

SPARE PARTS

Designation	Clamping screw	Wrench 1	Coolant plug	Wrench 2	DirectJet plug	Wrench 3
JSXXR**-S	CSTC-4L055DL	T-1008/5	-	-	-	-
JSXXL**-S	CSTC-4L055DR	T-1008/5	-	-	-	-
JSXXR**F**-S-CHP	CSTC-4L055DL	T-1008/5	SR5/16UNFTL360	P-4	-	-
JSXXL**F**-S-CHP	CSTC-4L055DR	T-1008/5	SR5/16UNFTL360	P-4	-	-
JSXXR**X**-S-CHP	CSTC-4L055DL	T-1008/5	SR5/16UNFTL360	P-4	SSHM4-6-TB	P-2
JSXXL**X**-S-CHP	CSTC-4L055DR	T-1008/5	SR5/16UNFTL360	P-4	SSHM4-6-TB	P-2

Reference pages: Inserts → **F074, F075**, Standard cutting conditions → **F076**
Parts for coolant hose → **F266**

JS-SXXL09

External grooving and threading toolholder with round shank, for Swiss lathes

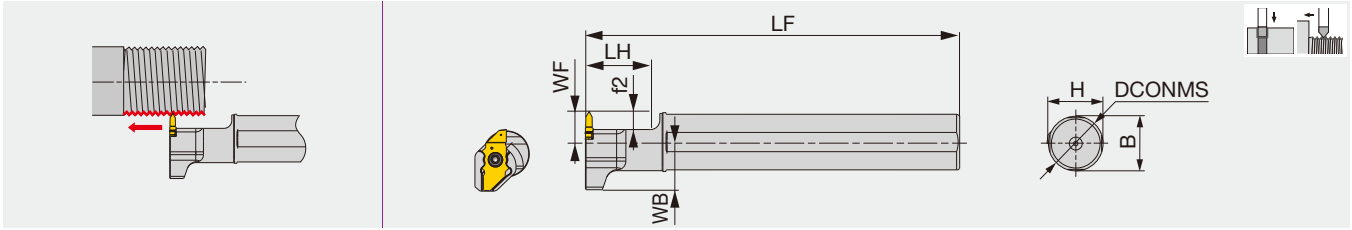

Designation	DCONMS	H	B	LF	LH	WB	WF ⁽¹⁾	f2 ⁽¹⁾	Insert	Torque*
JS19G-SXXL09	19.05	18	18	90	21	15.43	10	6	JX**06,12*R	1.2
JS19X-SXXL09	19.05	18	18	120	21	15.43	10	6	JX**06,12*R	1.2
JS20G-SXXL09	20	19	19	90	21	15.4	10	6	JX**06,12*R	1.2
JS20X-SXXL09	20	19	19	120	21	15.4	10	6	JX**06,12*R	1.2
JS22X-SXXL09	22	21	21	120	21	15.4	10	6	JX**06,12*R	1.2
JS25H-SXXL09	25	24	24	100	21	15.4	10	6	JX**06,12*R	1.2
JS254X-SXXL09	25.4	24	24	120	21	15.4	10	6	JX**06,12*R	1.2

*Torque: Recommended clamping torque (N·m)

(1) When using JX..06... insert, both WF and f2 sizes will be 2 mm shorter than the values provided above.

SPARE PARTS



Designation	Clamping screw	Wrench
JS***-SXXL09	CSTC-4L100DL	T-1008/5

Reference pages: Inserts → **F074, F075**, Standard cutting conditions → **F076**



INSERTS

JXPS**R/L-F (with 3D chipbreaker, sharp edge)

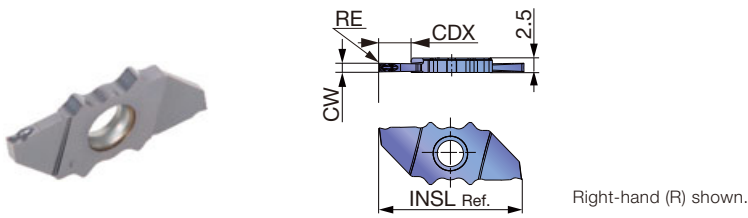

P	Steel	★					
M	Stainless	★					
K	Cast iron	★					
N	Non-ferrous						
S	Superalloys	★					
H	Hard materials						

★ : First choice

Designation	HAND	CW±0.025	RE	Coated				CUTDIA	CDX*	INSL
				SH725						
JXPS06R06F	R	0.6	0.05	●				6	3.5	21
JXPS06L06F	L	0.6	0.05	●				6	3.5	21
JXPS12R08F	R	0.8	0.05	●				12	6.5	25
JXPS12L08F	L	0.8	0.05	●				12	6.5	25
JXPS12R10F	R	1	0.05	●				12	6.5	25
JXPS12L10F	L	1	0.05	●				12	6.5	25
JXPS12R15F	R	1.5	0.05	●				12	6.5	25
JXPS12L15F	L	1.5	0.05	●				12	6.5	25
JXPS16R15F	R	1.5	0.05	●				16	8.5	29
JXPS16L15F	L	1.5	0.05	●				16	8.5	29
JXPS20R20F	R	2	0.05	●				20	10.5	33
JXPS20L20F	L	2	0.05	●				20	10.5	33

*Max grooving depth (CDX) varies depending on workpiece diameters.

● : Line up

JXDX**R-F (PCD insert)

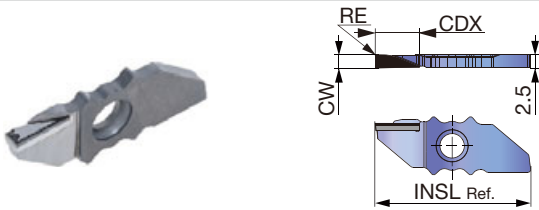

P	Steel						
M	Stainless						
K	Cast iron						
N	Non-ferrous	★					
S	Superalloys						
H	Hard materials						

★ : First choice

Designation	HAND	CW±0.05	RE	PCD				CDX	INSL
				DX110					
JXDX12R20F	R	2	< 0.1	●				6	25
JXDX12R25F	R	2.5	< 0.1	●				6.5	25
JXDX16R25F	R	2.5	< 0.1	●				7	29

● : Line up

Reference pages: Toolholders → **F071 - F073**, Standard cutting conditions → **F076**

JXPGR/L-F (Sharp edge)**

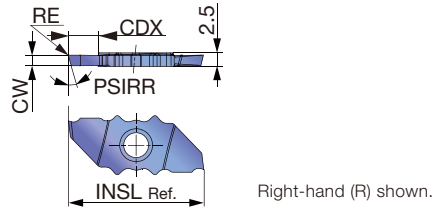

P	Steel	★						
M	Stainless	★						
K	Cast iron	★						
N	Non-ferrous							
S	Superalloys	★						
H	Hard materials							

★ : First choice

Designation	HAND	CW±0.025	RE	Coated				CUTDIA	CDX*	INSL	PSIRR
				SH725							
JXPG06R10F	R	1	0.05	●				6	3.5	21	0°
JXPG06L10F	L	1	0.05	●				6	3.5	21	0°
JXPG06R15F	R	1.5	0.05	●				6	3.5	21	0°
JXPG06L15F	L	1.5	0.05	●				6	3.5	21	0°
JXPG06R10F-15	R	1	0.05	●				6	3.5	21	15°
JXPG06L10F-15	L	1	0.05	●				6	3.5	21	15°
JXPG06R15F-15	R	1.5	0.05	●				6	3.5	21	15°
JXPG06L15F-15	L	1.5	0.05	●				6	3.5	21	15°
JXPG12R15F	R	1.5	0.05	●				12	6.5	25	0°
JXPG12L15F	L	1.5	0.05	●				12	6.5	25	0°
JXPG12R20F	R	2	0.05	●				12	6.5	25	0°
JXPG12L20F	L	2	0.05	●				12	6.5	25	0°
JXPG12R15F-15	R	1.5	0.05	●				12	6.5	25	15°
JXPG12L15F-15	L	1.5	0.05	●				12	6.5	25	15°
JXPG12R20F-15	R	2	0.05	●				12	6.5	25	15°
JXPG12L20F-15	L	2	0.05	●				12	6.5	25	15°
JXPG16R15F	R	1.5	0.05	●				16	8.5	29	0°
JXPG16L15F	L	1.5	0.05	●				16	8.5	29	0°
JXPG16R20F	R	2	0.05	●				16	8.5	29	0°
JXPG16L20F	L	2	0.05	●				16	8.5	29	0°
JXPG16R15F-15	R	1.5	0.05	●				16	8.5	29	15°
JXPG16L15F-15	L	1.5	0.05	●				16	8.5	29	15°
JXPG16R20F-15	R	2	0.05	●				16	8.5	29	15°
JXPG16L20F-15	L	2	0.05	●				16	8.5	29	15°
JXPG20R15F	R	1.5	0.05	●				20	10.5	33	0°
JXPG20L15F	L	1.5	0.05	●				20	10.5	33	0°
JXPG20R20F	R	2	0.05	●				20	10.5	33	0°
JXPG20L20F	L	2	0.05	●				20	10.5	33	0°
JXPG20R15F-15	R	1.5	0.05	●				20	10.5	33	15°
JXPG20L15F-15	L	1.5	0.05	●				20	10.5	33	15°
JXPG20R20F-15	R	2	0.05	●				20	10.5	33	15°
JXPG20L20F-15	L	2	0.05	●				20	10.5	33	15°

*Max grooving depth (CDX) varies depending on workpiece diameters.

● : Line up

Reference pages: Toolholders → **F071 - F073**, Standard cutting conditions → **F076**



STANDARD CUTTING CONDITIONS

Parting, Grooving

ISO	Workpiece materials	Grades	Cutting speed Vc (m/min)	Feed f (mm/rev)
P	Low carbon steels S15C, SS400, etc. C15E4, E275A, etc.	SH725	50 - 200	0.01 - 0.05
	Carbon steels, Alloy steels S55C, SCM440, etc. C55, 42CrMo4, etc.	SH725	50 - 200	0.01 - 0.05
	Free cutting steels SUH22, SUH23, etc.	SH725	50 - 200	0.01 - 0.05
M	Stainless steels SUS304, X5CrNi18-9, etc.	SH725	50 - 200	0.01 - 0.05
N	Aluminium alloys A5056, A6061, etc.	SH725	150 - 200	0.01 - 0.05
	Copper alloy C2600, C280C, etc.	SH725	100 - 200	0.01 - 0.05
S	Titanium alloys Ti-6Al-4V, etc.	SH725	30 - 80	0.01 - 0.05
	Superalloys Inconel718, etc.	SH725	30 - 80	0.01 - 0.05



For aluminium and non-ferrous metal PCD insert

ISO	Workpiece materials	Grades	Operation	Cutting speed Vc (m/min)	Feed f (mm/rev)	Depth of cut ap (mm)
N	Aluminium alloys A5056, A6061, etc.	DX110	Grooving	100 - 300	0.03 - 0.15	-
		DX110	Turning	100 - 300	0.03 - 0.15	< 6

Maximum grooving depths (T) in relation to workpiece diameters (øD max) without interference

Maximum grooving depth (T) is limited relative to workpiece diameter (øD max) to avoid interference between workpiece and insert.

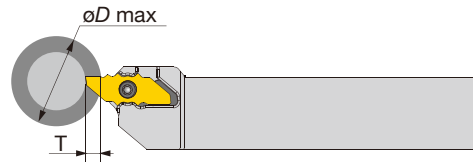

Grooving depths (T) and workpiece diameters (øD max) for each insert

Designation	T≤1.0	T≤2.0	T≤2.5	T≤3.0	T≤3.5	T≤4.0	T≤5.0	T≤5.5	T≤6.0	T≤6.5	T≤7.0	T≤7.5	T≤8.0	T≤8.5	T≤9.0	T≤9.5	T≤10.0	T≤10.5
JXP*06...	∞	∞	200	60	30	-	-	-	-	-	-	-	-	-	-	-	-	-
JXP*12...	∞	∞	∞	∞	∞	∞	∞	100	60	35	-	-	-	-	-	-	-	-
JXP*16...	∞	∞	∞	∞	∞	∞	∞	∞	∞	∞	200	90	50	25	-	-	-	-
JXP*20...	∞	∞	∞	∞	∞	∞	∞	∞	∞	∞	∞	∞	∞	∞	200	80	50	25

MY-T SERIES

CGWSR/L-W

External grooving, parting and turning toolholder, for 2 corner inserts

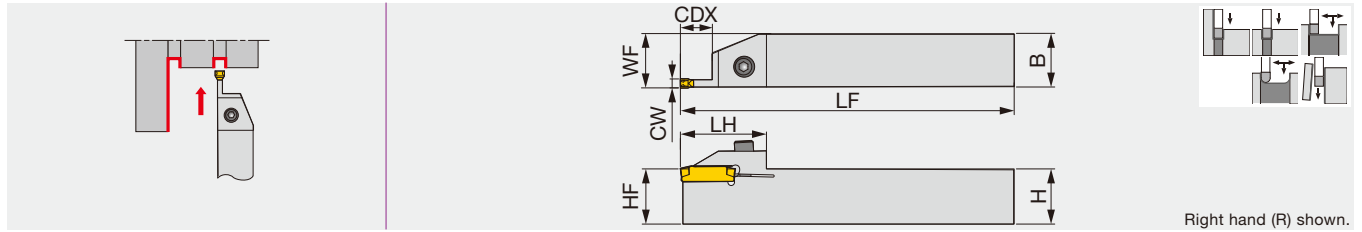

Designation	CW	CDX	H	B	LF	LH	HF	WF	Insert	Torque*
CGWSR/L1616-W30	3	12	16	16	125	34	16	16.4	WG*30, WGE30R/L	5
CGWSR/L2020-W30	3	12	20	20	150	34	20	20.4	WG*30, WGE30R/L	5
CGWSR/L2525-W30	3	12	25	25	150	34	25	25.4	WG*30, WGE30R/L	5
CGWSR/L2020-W40	4	13	20	20	150	39	20	20.4	WG*40, WGE40R/L	5
CGWSR/L2525-W40	4	13	25	25	150	39	25	25.4	WG*40, WGE40R/L	5
CGWSR/L2020-W50	5	13	20	20	150	39	20	20.4	WG*50, WGE50R/L	5
CGWSR/L2525-W50	5	13	25	25	150	39	25	25.4	WG*50, WGE50R/L	5

*Torque: Recommended clamping torque (N·m)

CGWSR/L-W-L

External deep grooving, parting and turning toolholder, for 2 corner inserts

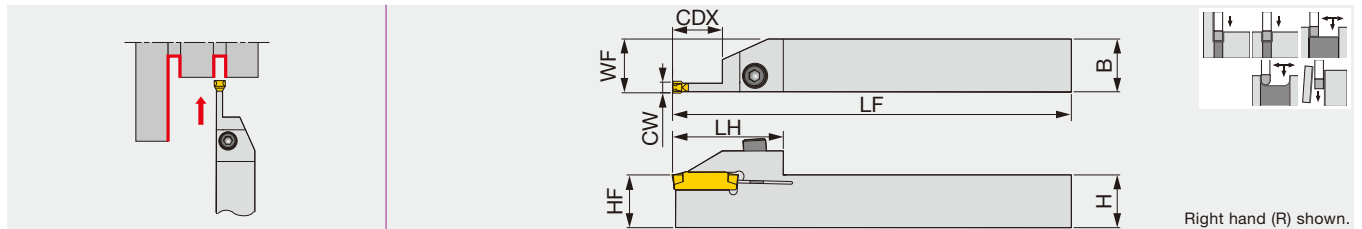

Designation	CW	CDX	H	B	LF	LH	HF	WF	Insert	Torque*
CGWSR/L1616-W20-L	2	15	16	16	125	37	16	16.2	WGE20, WGE20R/L	5
CGWSR/L2020-W20-L	2	15	20	20	150	37	20	20.2	WGE20, WGE20R/L	5
CGWSR/L2525-W20-L	2	15	25	25	150	37	25	25.2	WGE20, WGE20R/L	5
CGWSR/L1616-W30-L	3	16.5, 17.5 ⁽¹⁾	16	16	125	37	16	16.4	WG*30, WGE30R/L	5
CGWSR/L2020-W30-L	3	16.5, 17.5 ⁽¹⁾	20	20	150	37	20	20.4	WG*30, WGE30R/L	5
CGWSR/L2525-W30-L	3	16.5, 17.5 ⁽¹⁾	25	25	150	37	25	25.4	WG*30, WGE30R/L	5
CGWSR/L2020-W40-L	4	21, 21.5 ⁽¹⁾	20	20	150	42	20	20.4	WG*40, WGE40R/L	5
CGWSR/L2525-W40-L	4	21, 21.5 ⁽¹⁾	25	25	150	42	25	25.4	WG*40, WGE40R/L	5
CGWSR/L2020-W50-L	5	21	20	20	150	42	20	20.4	WG*50, WGE50R/L	5
CGWSR/L2525-W50-L	5	21	25	25	150	42	25	25.4	WG*50, WGE50R/L	5

*Torque: Recommended clamping torque (N·m)

(1) The value is true when using the WGR insert.

SPARE PARTS

Designation	Clamping screw	Wrench
CGWSR/L***-W...	CHHM5-18	P-4

Reference pages: Inserts → **F082 - F084**, Standard cutting conditions → **F084**



MY-T SERIES

CGWSR/L-WG

External grooving, parting and turning toolholder, for 2 corner inserts

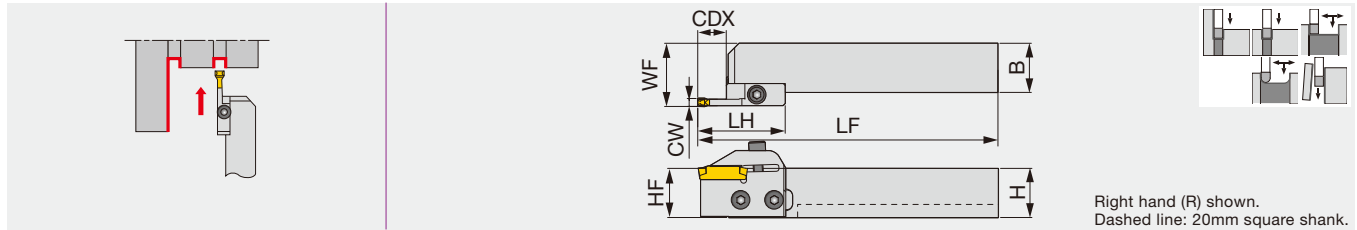

Designation	CW	CDX	H	B	LF	LH	HF	WF	Insert	Shank	Adapter	Torque*
CGWSR/L2020-W30GR/L	3	12	20	20	150.5	43.5	20	26.9	WG*30, WGE30R/L	CGWSR/L2020	W30GR/L	5
CGWSR/L2525-W30GR/L	3	12	25	25	150.5	43.5	25	31.9	WG*30, WGE30R/L	CGWSR/L2525	W30GR/L	5
CGWSR/L2020-W40GR/L	4	13	20	20	151.5	44.5	20	26.9	WG*40, WGE40R/L	CGWSR/L2020	W40GR/L	5
CGWSR/L2525-W40GR/L	4	13	25	25	151.5	44.5	25	31.9	WG*40, WGE40R/L	CGWSR/L2525	W40GR/L	5
CGWSR/L2020-W50GR/L	5	13	20	20	151.5	44.5	20	26.9	WG*50, WGE50R/L	CGWSR/L2020	W50GR/L	5
CGWSR/L2525-W50GR/L	5	13	25	25	151.5	44.5	25	31.9	WG*50, WGE50R/L	CGWSR/L2525	W50GR/L	5

Note: Use right-hand adapters (R) with right-hand shanks (R); and left-hand adapters (L) with left-hand shanks (L).
*Torque: Recommended clamping torque (N·m)

CGWSR/L-WG-L

External deep grooving, parting and turning toolholder, for 2 corner inserts

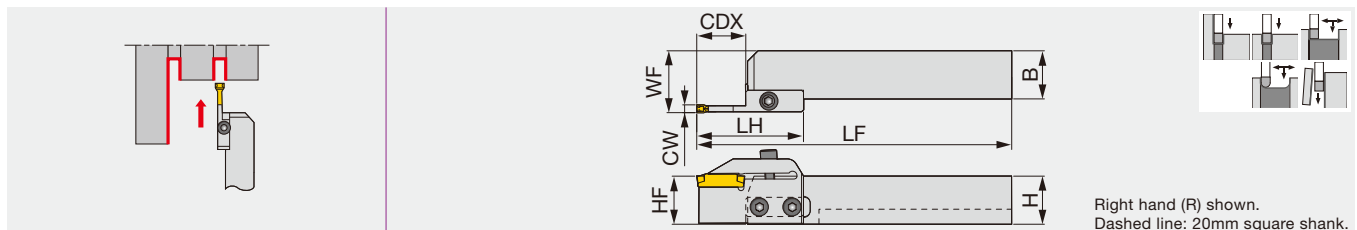

Designation	CW	CDX	H	B	LF	LH	HF	WF	Insert	Shank	Adapter	Torque*
CGWSR/L2020-W20GR/L-L	2	15	20	20	153.5	46.5	20	26.7	WGE20, WGE20R/L	CGWSR/L2020	W20GR/L-L	5
CGWSR/L2525-W20GR/L-L	2	15	25	25	153.5	46.5	25	31.7	WGE20, WGE20R/L	CGWSR/L2525	W20GR/L-L	5
CGWSR/L2020-W30GR/L-L	3	16.5, 17.5 ⁽¹⁾	20	20	157.5	50.5	20	26.9	WG*30, WGE30R/L	CGWSR/L2020	W30GR/L-L	5
CGWSR/L2525-W30GR/L-L	3	16.5, 17.5 ⁽¹⁾	25	25	157.5	50.5	25	31.9	WG*30, WGE30R/L	CGWSR/L2525	W30GR/L-L	5
CGWSR/L2020-W40GR/L-L	4	21, 21.5 ⁽¹⁾	20	20	162.5	55.5	20	26.9	WG*40, WGE40R/L	CGWSR/L2020	W40GR/L-L	5
CGWSR/L2525-W40GR/L-L	4	21, 21.5 ⁽¹⁾	25	25	162.5	55.5	25	31.9	WG*40, WGE40R/L	CGWSR/L2525	W40GR/L-L	5
CGWSR/L2020-W50GR/L-L	5	21	20	20	162.5	55.5	20	26.9	WG*50, WGE50R/L	CGWSR/L2020	W50GR/L-L	5
CGWSR/L2525-W50GR/L-L	5	21	25	25	162.5	55.5	25	31.9	WG*50, WGE50R/L	CGWSR/L2525	W50GR/L-L	5

Note: Use right-hand adapters (R) with right-hand shanks (R); and left-hand adapters (L) with left-hand shanks (L).
*Torque: Recommended clamping torque (N·m)
(1) The value is true when using the WGR insert.

SPARE PARTS

Designation	Clamping screw	Adapter screw	Wrench
CGWSR/L***-W**G...	CHHM5-18	CSHB-6	P-4

Combination of adapter and shank

Shank	Adapter	
	**GR, **GR-L	**GL, **GL-L
CGWSR...	●	
CGWSL...		●
CGWTR...		●
CGWTL...	●	

● : Corresponding

Reference pages: Inserts → **F082 - F084**, Shanks → **F081**, Standard cutting conditions → **F084**

CGWSR/L-G

External grooving, parting and turning toolholder, for 1 corner inserts

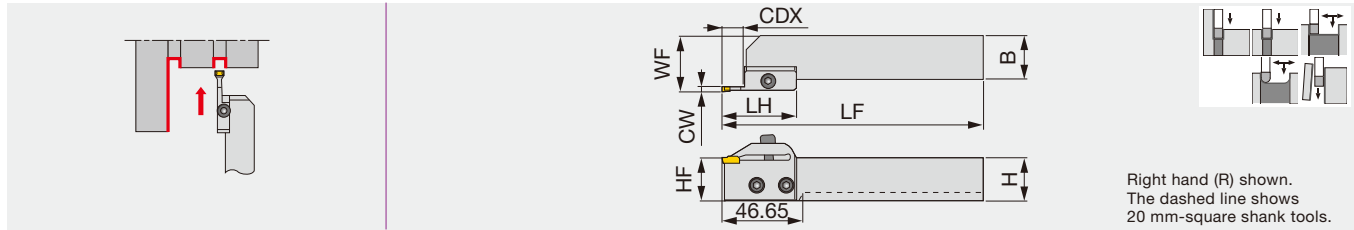

Designation	CW	CDX	H	B	LF	LH	HF	WF	Insert	Shank	Adapter	Torque*
CGWSR/L2020-20GR/L	2	12	20	20	150.2	43.15	20	26.8	GE20, GE20-AL	CGWSR/L2020	20GR/L	5
CGWSR/L2525-20GR/L	2	12	25	25	150.2	43.15	25	31.8	GE20, GE20-AL	CGWSR/L2525	20GR/L	5
CGWSR/L2020-30GR/L	3	12	20	20	150.2	43.15	20	27	G*30,GE30R/L,GE30-AL	CGWSR/L2020	30GR/L	5
CGWSR/L2525-30GR/L	3	12	25	25	150.2	43.15	25	32	G*30,GE30R/L,GE30-AL	CGWSR/L2525	30GR/L	5
CGWSR/L2020-40GR/L	4	12	20	20	150.2	43.15	20	27.1	G*40,GE40R/L,GE40-AL	CGWSR/L2020	40GR/L	5
CGWSR/L2525-40GR/L	4	12	25	25	150.2	43.15	25	32.1	G*40,GE40R/L,GE40-AL	CGWSR/L2525	40GR/L	5
CGWSR/L2020-50GR/L	5	12	20	20	150.2	43.15	20	27.2	G*50,GE50R	CGWSR/L2020	50GR	5

Note: For diameter compensation values in traversing, see page F115.

Use right-hand adapters (R) with right-hand shanks (R); and left-hand adapters (L) with left-hand shanks (L).

*Torque: Recommended clamping torque (N·m)

CGWTR/L-G

External grooving, parting and turning toolholder, for 1 corner inserts

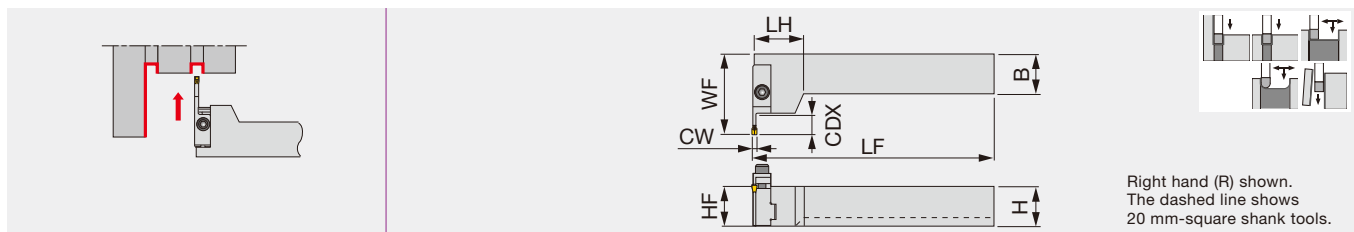

Designation	CW	CDX	H	B	LF	LH	HF	WF	Insert	Shank	Adapter	Torque*
CGWTR/L2020-30GL/R	3	12	20	20	150	12.9	20	49.9	G*30,GE30R/L,GE30-AL	CGWTR/L2020	30GL/R	5
CGWTR/L2525-30GL/R	3	12	25	25	150	12.9	25	49.9	G*30,GE30R/L,GE30-AL	CGWTR/L2525	30GL/R	5
CGWTR/L2020-40GL/R	4	12	20	20	150.1	12.9	20	49.9	G*40,GE40R/L,GE40-AL	CGWTR/L2020	40GL/R	5
CGWTR/L2525-40GL/R	4	12	25	25	150.1	12.9	25	49.9	G*40,GE40R/L,GE40-AL	CGWTR/L2525	40GL/R	5
CGWTR/L2020-50GL/R	5	12	20	20	150.2	12.9	20	49.9	G*50,GE50R/L,GE50-AL	CGWTR/L2020	50GL/R	5
CGWTR/L2525-50GL/R	5	12	25	25	150.2	12.9	25	49.9	G*50,GE50R/L,GE50-AL	CGWTR/L2525	50GL/R	5

Note: For diameter compensation values in traversing, see page F115.

Use left-hand adapters (L) with right-hand shanks (R); and right-hand adapters (R) with left-hand shanks (L).

*Torque: Recommended clamping torque (N·m)

SPARE PARTS

Designation	Clamping screw	Adapter screw	Wrench
CGW*R/L***-G...	CHHM5-18	CSHB-6	P-4

Combination of adapter and shank

Shank	Adapter	
	**GR, **GR-L	**GL, **GL-L
CGWSR...	●	
CGWSL...		●
CGWTR...		●
CGWTL...	●	

● : Corresponding

Reference pages: Inserts → F085 - F090, Shanks → F081, Standard cutting conditions → F090

MY-T SERIES

CGSSR/L

External grooving, parting and turning toolholder, for 1 corner inserts

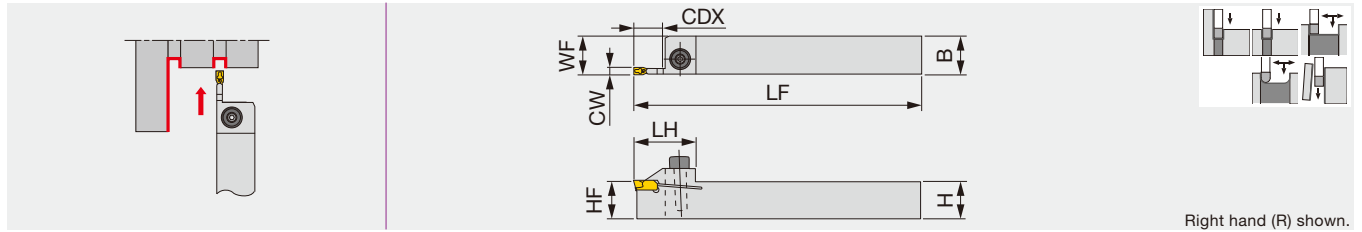

Designation	CW	CDX	H	B	LF	LH	HF	WF	Insert	Torque*
CGSSR/L1616-20	2	16	16	16	125	27	16	16.2	GE20, GE20-AL	5
CGSSR/L2020-20	2	16	20	20	150	27	20	20.2	GE20, GE20-AL	5
CGSSR/L2525-20	2	16	25	25	150	27	25	25.2	GE20, GE20-AL	5
CGSSR/L1616-30	3	12	16	16	125	27	16	16.5	G*30, GE30R/L, GE30-AL	5
CGSSR/L2020-30	3	12	20	20	150	27	20	20.5	G*30, GE30R/L, GE30-AL	5
CGSSR/L2525-30	3	12	25	25	150	27	25	25.5	G*30, GE30R/L, GE30-AL	5
CGSSR/L2020-40	4	12	20	20	150	27	20	20.6	G*40, GE40R/L, GE40-AL	5
CGSSR/L2525-40	4	12	25	25	150	27	25	25.6	G*40, GE40R/L, GE40-AL	5
CGSSR/L2020-50	5	12	20	20	150	27	20	20.7	G*50, GE50R/L, GE50-AL	5
CGSSR/L2525-50	5	12	25	25	150	27	25	25.7	G*50, GE50R/L, GE50-AL	5

*Torque: Recommended clamping torque (N·m)

CGSSR/L-D

External grooving, parting and turning toolholder, for 1 corner inserts

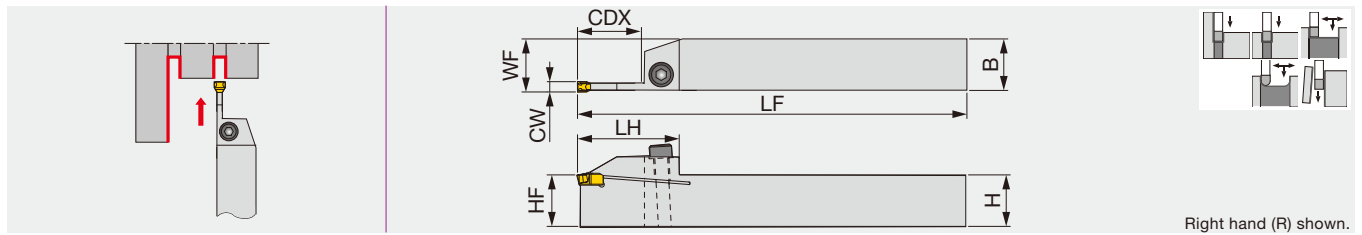

Designation	CW	CDX	H	B	LF	LH	HF	WF	Insert	Torque*
CGSSR/L1616-30D	3	22	16	16	125	36.2	16	16.5	G*30, GE30R/L, GE30-AL	5
CGSSR/L2020-30D	3	22	20	20	150	36.2	20	20.5	G*30, GE30R/L, GE30-AL	5
CGSSR/L2525-30D	3	22	25	25	150	36.2	25	25.5	G*30, GE30R/L, GE30-AL	5
CGSSR/L2020-40D	4	25	20	20	150	39.5	20	20.6	G*40, GE40R/L, GE40-AL	5
CGSSR/L2525-40D	4	25	25	25	150	39.5	25	25.6	G*40, GE40R/L, GE40-AL	5
CGSSR/L2020-50D	5	25	20	20	150	39.5	20	20.7	G*50, GE50R/L	5
CGSSR/L2525-50D	5	25	25	25	150	39.5	25	25.7	G*50, GE50R/L	5

*Torque: Recommended clamping torque (N·m)

SPARE PARTS

Designation	Clamping screw	Wrench
CGSSR/L...	CHHM5-18	P-4

Reference pages: Inserts → **F085 - F090**, Standard cutting conditions → **F090**

JCGSSR/L

External grooving and parting toolholder, for Swiss lathes

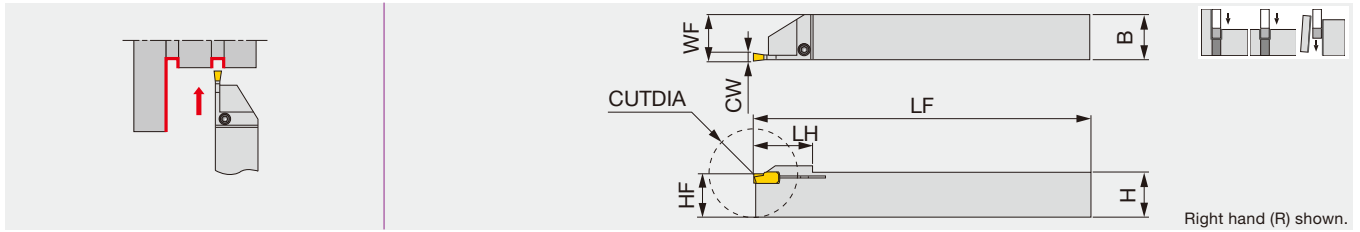

Designation	CW	CUTDIA	H	B	LF	LH	HF	WF	Insert	Torque*
JCGSSR/L1010-20	2	20	10	10	125	15	10	10.2	GE20, GE20-AL	2.3
JCGSSR/L1212-20	2	25	12	12	125	19	12	12.2	GE20, GE20-AL	2.3
JCGSSR/L1616-20	2	32	16	16	125	22.5	16	16.2	GE20, GE20-AL	2.3

*Torque: Recommended clamping torque (N·m)

SPARE PARTS

Designation	Clamping screw	Wrench
JCGSSR/L...	CSTB-3	T-9F

CGWSR/L

Shank for CGWSR/L-WG, -WG-L, -G, -CGD, -FL-G/TP, and -#S/D toolholders

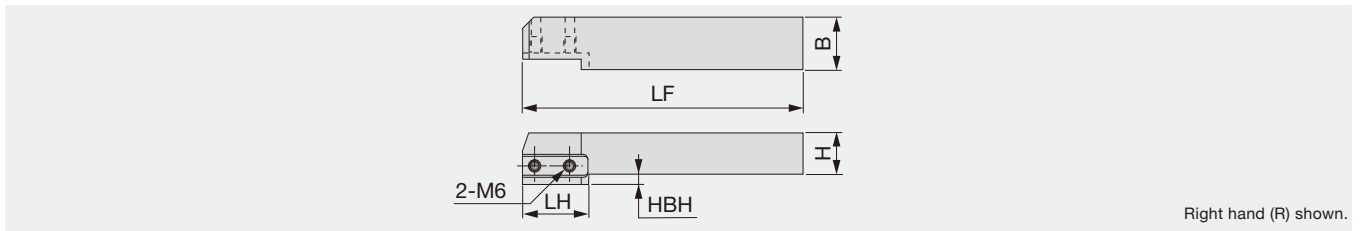

Designation	H	B	LF	LH	HBH
CGWSR/L2020	20	20	137	32.5	5
CGWSR/L2525	25	25	137	-	-

CGWTR/L

Shank for CGWSR/L-WG, -WG-L, -G, -CGD, -FL-G/TP, and -#S/D toolholders, for tangentially clamped adapter

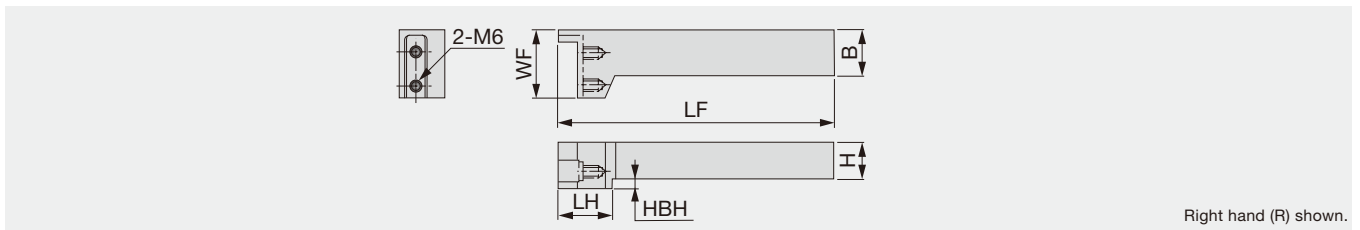

Designation	H	B	LF	LH	WF	HBH
CGWTR/L2020	20	20	150	30.5	37	5
CGWTR/L2525	25	25	150	-	37	-

SPARE PARTS

Designation	Adapter screw
CGWTR/L...	CSHB-6

Reference pages: Inserts → **F085 - F090**, Standard cutting conditions → **F090**

CHIPBREAKER GUIDE (for 2 corner inserts)

External grooving and parting

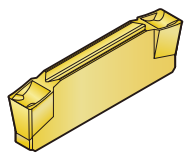
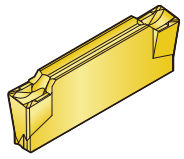
<p>WGE</p>  <p>F083</p>	<p>1st choice for external grooving and parting Excellent chip control for grooving CW = 2 - 5 mm</p>	<table border="1"> <caption>Feed: f (mm/rev) vs Groove width: CW (mm) for WGE</caption> <thead> <tr> <th>Groove width: CW (mm)</th> <th>External (mm/rev)</th> <th>Internal (mm/rev)</th> <th>Face (mm/rev)</th> <th>Parting (mm/rev)</th> </tr> </thead> <tbody> <tr> <td>2</td> <td>0.20</td> <td>0.13</td> <td>0.23</td> <td>0.13</td> </tr> <tr> <td>3</td> <td>0.25</td> <td>0.13</td> <td>0.27</td> <td>0.13</td> </tr> <tr> <td>4</td> <td>0.27</td> <td>0.13</td> <td>0.27</td> <td>0.13</td> </tr> <tr> <td>5</td> <td>0.30</td> <td>0.13</td> <td>0.27</td> <td>0.13</td> </tr> </tbody> </table>	Groove width: CW (mm)	External (mm/rev)	Internal (mm/rev)	Face (mm/rev)	Parting (mm/rev)	2	0.20	0.13	0.23	0.13	3	0.25	0.13	0.27	0.13	4	0.27	0.13	0.27	0.13	5	0.30	0.13	0.27	0.13
Groove width: CW (mm)	External (mm/rev)	Internal (mm/rev)	Face (mm/rev)	Parting (mm/rev)																							
2	0.20	0.13	0.23	0.13																							
3	0.25	0.13	0.27	0.13																							
4	0.27	0.13	0.27	0.13																							
5	0.30	0.13	0.27	0.13																							
<p>WGE R/L</p>  <p>F083</p>	<p>Handed insert Minimize burr generation when workpiece is cut off CW = 2 - 5 mm</p>	<table border="1"> <caption>Feed: f (mm/rev) vs Groove width: CW (mm) for WGE R/L</caption> <thead> <tr> <th>Groove width: CW (mm)</th> <th>External (mm/rev)</th> </tr> </thead> <tbody> <tr> <td>2</td> <td>0.10</td> </tr> <tr> <td>3</td> <td>0.15</td> </tr> <tr> <td>4</td> <td>0.15</td> </tr> <tr> <td>5</td> <td>0.15</td> </tr> </tbody> </table>	Groove width: CW (mm)	External (mm/rev)	2	0.10	3	0.15	4	0.15	5	0.15															
Groove width: CW (mm)	External (mm/rev)																										
2	0.10																										
3	0.15																										
4	0.15																										
5	0.15																										

- External
- Internal
- Face
- Parting
- Others

External grooving and turning

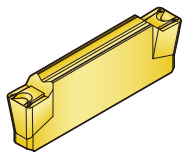
<p>WGT</p>  <p>F084</p>	<p>1st choice for turning Low cutting force and good chip control for traversing CW = 3 - 5 mm</p>	<table border="1"> <caption>Depth of cut ap (mm) vs Feed: f (mm/rev) for WGT</caption> <thead> <tr> <th>Feed: f (mm/rev)</th> <th>WGT50 (mm)</th> <th>WGT40 (mm)</th> <th>WGT30 (mm)</th> </tr> </thead> <tbody> <tr> <td>0.05</td> <td>2.0</td> <td>1.8</td> <td>1.5</td> </tr> <tr> <td>0.10</td> <td>2.0</td> <td>1.8</td> <td>1.5</td> </tr> <tr> <td>0.15</td> <td>2.0</td> <td>1.8</td> <td>1.5</td> </tr> <tr> <td>0.20</td> <td>2.0</td> <td>1.8</td> <td>1.5</td> </tr> <tr> <td>0.25</td> <td>2.0</td> <td>1.8</td> <td>1.5</td> </tr> <tr> <td>0.30</td> <td>2.0</td> <td>1.8</td> <td>1.5</td> </tr> </tbody> </table>	Feed: f (mm/rev)	WGT50 (mm)	WGT40 (mm)	WGT30 (mm)	0.05	2.0	1.8	1.5	0.10	2.0	1.8	1.5	0.15	2.0	1.8	1.5	0.20	2.0	1.8	1.5	0.25	2.0	1.8	1.5	0.30	2.0	1.8	1.5
Feed: f (mm/rev)	WGT50 (mm)	WGT40 (mm)	WGT30 (mm)																											
0.05	2.0	1.8	1.5																											
0.10	2.0	1.8	1.5																											
0.15	2.0	1.8	1.5																											
0.20	2.0	1.8	1.5																											
0.25	2.0	1.8	1.5																											
0.30	2.0	1.8	1.5																											

Profiling

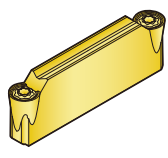
<p>WGR</p>  <p>F084</p>	<p>Low cutting force and good chip control for profiling CW = 3 - 5 mm</p>	<table border="1"> <caption>Depth of cut ap (mm) vs Feed: f (mm/rev) for WGR</caption> <thead> <tr> <th>Feed: f (mm/rev)</th> <th>WGR50 (mm)</th> <th>WGR40 (mm)</th> <th>WGR30 (mm)</th> </tr> </thead> <tbody> <tr> <td>0.05</td> <td>2.0</td> <td>1.8</td> <td>1.5</td> </tr> <tr> <td>0.10</td> <td>2.0</td> <td>1.8</td> <td>1.5</td> </tr> <tr> <td>0.15</td> <td>2.0</td> <td>1.8</td> <td>1.5</td> </tr> <tr> <td>0.20</td> <td>2.0</td> <td>1.8</td> <td>1.5</td> </tr> <tr> <td>0.25</td> <td>2.0</td> <td>1.8</td> <td>1.5</td> </tr> <tr> <td>0.30</td> <td>2.0</td> <td>1.8</td> <td>1.5</td> </tr> </tbody> </table>	Feed: f (mm/rev)	WGR50 (mm)	WGR40 (mm)	WGR30 (mm)	0.05	2.0	1.8	1.5	0.10	2.0	1.8	1.5	0.15	2.0	1.8	1.5	0.20	2.0	1.8	1.5	0.25	2.0	1.8	1.5	0.30	2.0	1.8	1.5
Feed: f (mm/rev)	WGR50 (mm)	WGR40 (mm)	WGR30 (mm)																											
0.05	2.0	1.8	1.5																											
0.10	2.0	1.8	1.5																											
0.15	2.0	1.8	1.5																											
0.20	2.0	1.8	1.5																											
0.25	2.0	1.8	1.5																											
0.30	2.0	1.8	1.5																											

Please see page F*** for the product details.

INSERTS (2 corners)

WGE

For external grooving and parting

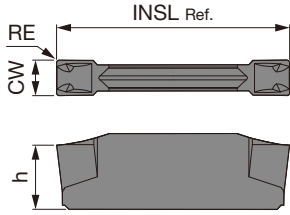

P	Steel	★	★	★					★				
M	Stainless		★	★									
K	Cast iron		★	☆					☆				
N	Non-ferrous												
S	Superalloys			☆									
H	Hard materials												

★ : First choice
☆ : Second choice

Designation	CW ^{+0.1}	RE	Coated			Cermet			INSL	h
			T9225	AH120	GH730	NS9530				
WGE20	2	0.2	●	●	●			●	20	4.7
WGE30	3	0.2	●	●	●			●	20	5.5
WGE40	4	0.2	●	●	●			●	25	5.7
WGE50	5	0.2	●	●	●			●	25	5.9

● : Line up

WGE(R/L)

For parting off (handed inserts)

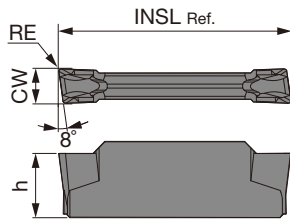

Right hand (R) shown.

P	Steel	★	★							
M	Stainless		★	★						
K	Cast iron		★	☆						
N	Non-ferrous									
S	Superalloys			☆						
H	Hard materials									

★ : First choice
☆ : Second choice

Designation	HAND	CW ^{+0.1}	RE	Coated								INSL	h
				AH120	GH730								
WGE20R	R	2	0.2									20	4.7
WGE20L	L	2	0.2		●							20	4.7
WGE30R	R	3	0.2	●	●							20	5.5
WGE30L	L	3	0.2		●							20	5.5
WGE40R	R	4	0.2		●							25	5.7
WGE40L	L	4	0.2		●							25	5.7
WGE50R	R	5	0.2		●							25	5.9
WGE50L	L	5	0.2		●							25	5.9

● : Line up



WGT

For external grooving, parting, and turning

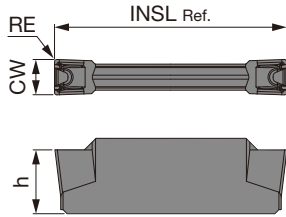

P	Steel	★	★	★					★				
M	Stainless		★	★									
K	Cast iron		★	☆					☆				
N	Non-ferrous												
S	Superalloys			☆									
H	Hard materials												

★ : First choice
☆ : Second choice

Designation	CW ^{+0.1} ₀	RE	Coated			Cermets			INSL	h
			T9225	AH120	GH730	NS9530				
WGT30	3	0.4	●	●	●	●			20	5.5
WGT40	4	0.4	●	●	●	●			25	5.7
WGT50	5	0.4	●	●	●	●			25	5.9

● : Line up

WGR

For profiling (full radius)

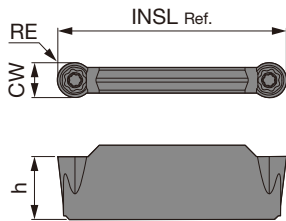

P	Steel	★	★	★					★				
M	Stainless		★	★									
K	Cast iron		★	☆					☆				
N	Non-ferrous												
S	Superalloys			☆									
H	Hard materials												

★ : First choice
☆ : Second choice

Designation	CW ^{+0.1} ₀	RE	Coated			Cermets			INSL	h
			T9225	AH120	GH730	NS9530				
WGR30	3	1.5	●	●	●	●			20	5.5
WGR40	4	2	●	●	●	●			25	5.7
WGR50	5	2.5	●	●	●	●			25	5.9

● : Line up

STANDARD CUTTING CONDITIONS (for 2 corner inserts)

ISO	Workpiece material	Recommended grade	Cutting speed V _c (m/min)	Operation	Feed: f (mm/rev)								
					Groove width: CW (mm)								
					2	3	4	5					
P	Low carbon steels Alloy steels (~ HB150)	T9225	80 - 300	Grooving (WGE□□)	0.06 ~ 0.20	0.06 ~ 0.25	0.07 ~ 0.27	0.07 ~ 0.30					
		NS9530	100 - 200										
		GH730, AH120	50 - 180										
	Medium carbon steels Alloy steels (HB150 ~ 250)	T9225	80 - 220						Parting (WGE□□R/L)	0.04 ~ 0.10	0.04 ~ 0.14	0.04 ~ 0.14	0.04 ~ 0.14
		NS9530	80 - 180										
		GH730, AH120	50 - 150										
High carbon steels Alloy steels (HB250 ~)	T9225	80 - 220	Turning (WGT□□)	-	ap = 0.5 ~ 1.5 f = 0.06 ~ 0.2	ap = 0.5 ~ 2.0 f = 0.06 ~ 0.25	ap = 0.5 ~ 2.5 f = 0.06 ~ 0.27						
	NS9530	80 - 150											
GH730, AH120	50 - 150												
M	Stainless steels	GH730, AH120						50 - 120	Profiling (WGR□□)	-	ap = 0.5 ~ 1.4 f = 0.05 ~ 0.25	ap = 0.5 ~ 1.5 f = 0.05 ~ 0.26	ap = 0.5 ~ 1.6 f = 0.05 ~ 0.3
		K						Grey and ductile cast irons					

Note: For diameter compensation values in traversing, see page F115.

Reference pages: Toolholders → F077, F078

CHIPBREAKER GUIDE (for 1 corner inserts)

External grooving and parting

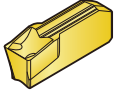
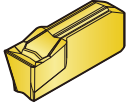
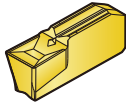
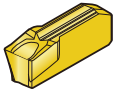
<p>GE</p>  <p>F087</p>	<p>1st choice for external grooving and parting Excellent chip control</p> <p>CW = 2 - 5 mm</p>	<p>Feed: f (mm/rev)</p> <p>Groove width : CW (mm)</p> <ul style="list-style-type: none"> External Internal Face Parting
<p>GF</p>  <p>F088</p>	<p>1st choice for face grooving Low cutting force and good chip control for face grooving</p> <p>CW = 3 - 5 mm</p>	<p>Feed: f (mm/rev)</p> <p>Groove width : CW (mm)</p> <ul style="list-style-type: none"> External
<p>GN</p>  <p>F089</p>	<p>1st choice for internal grooving Low cutting force and good chip control for internal grooving</p> <p>CW = 3 - 5 mm</p>	<p>Feed: f (mm/rev)</p> <p>Groove width : CW (mm)</p> <ul style="list-style-type: none"> External
<p>GE R/L</p>  <p>F089</p>	<p>Handed insert Minimize burr generation when workpiece is cut off</p> <p>CW = 3 - 5 mm</p>	<p>Feed: f (mm/rev)</p> <p>Groove width : CW (mm)</p> <ul style="list-style-type: none"> External

External grooving and turning

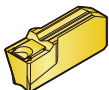
<p>GT</p>  <p>F087</p>	<p>1st choice for turning Low cutting force and good chip control for traversing</p> <p>CW = 3 - 5 mm</p>	<p>Depth of cut a_p (mm)</p> <p>Feed: f (mm/rev)</p> <ul style="list-style-type: none"> GT50 GT40 GT30
---	---	---

Please see page F*** for the product details.

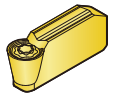
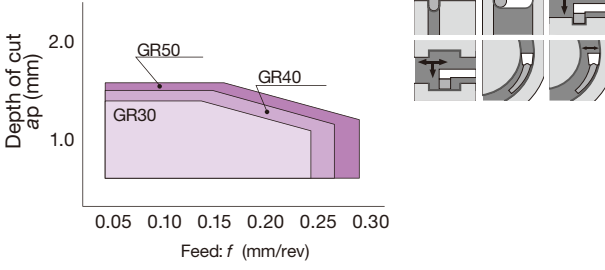

Profiling

<p>GR</p>  <p>F088</p>	<p>Full radius type Low cutting force and good chip control for profiling CW = 3 - 5 mm</p>	
---	---	--

For aluminium and non-ferrous metal

- External
- Internal
- Face
- Parting
- Others

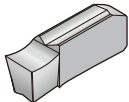
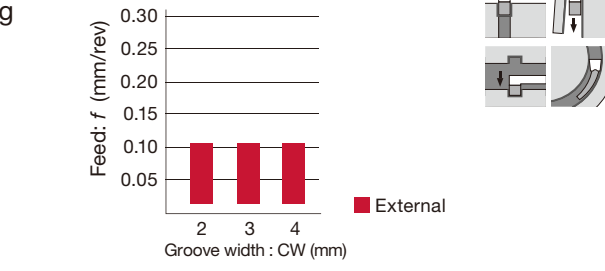
<p>GE-AL</p>  <p>F090</p>	<p>Reduce cutting force and welding due to sharp chipbreaker CW = 2 - 4 mm</p>	
--	--	--

Please see page F*** for the product details.

INSERTS (1 corner)

GE

For external grooving and parting

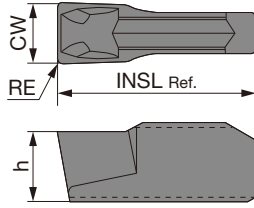

P	Steel	★	★	★					★											
M	Stainless		★	★																
K	Cast iron		★	☆					☆											
N	Non-ferrous																			
S	Superalloys			☆																
H	Hard materials																			

★ : First choice
☆ : Second choice

Designation	CW ₀ ^{+0.1}	RE	Coated			Cermets			INSL	h
			T9225	AH120	GH730	NS9530				
GE20	2	0.2		●	●			●	10	3.5
GE30	3	0.2	●	●	●			●	10	3.5
GE40	4	0.2	●	●	●			●	10	4
GE50	5	0.2	●	●	●			●	12	4.5

● : Line up

GT

For external grooving and turning

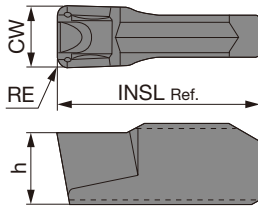

P	Steel	★	★	★					★											
M	Stainless		★	★																
K	Cast iron		★	☆					☆											
N	Non-ferrous																			
S	Superalloys			☆																
H	Hard materials																			

★ : First choice
☆ : Second choice

Designation	CW ₀ ^{+0.1}	RE	Coated			Cermets			INSL	h
			T9225	AH120	GH730	NS9530				
GT30	3	0.4		●	●			●	10	3.5
GT40	4	0.4	●	●	●			●	10	4
GT50	5	0.4	●	●	●			●	12	4.5

● : Line up



GR

For profiling (full radius)

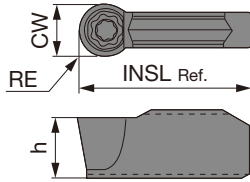

P	Steel	★	★	★				★					
M	Stainless		★	★									
K	Cast iron		★	☆				☆					
N	Non-ferrous												
S	Superalloys			☆									
H	Hard materials												

★ : First choice
☆ : Second choice

Designation	CW ^{+0.1}	RE	Coated			Cermet				INSL	h
			T9225	AH120	GH730	NS9530					
GR30	3	1.5	●	●	●	●				10	3.5
GR40	4	2	●	●	●	●				10	4
GR50	5	2.5	●	●	●	●				12	4.5

● : Line up

GF

For face grooving

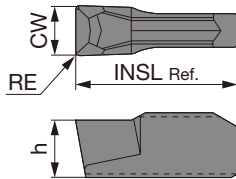

P	Steel	★		★									
M	Stainless	★											
K	Cast iron		☆		☆								
N	Non-ferrous												
S	Superalloys												
H	Hard materials												

★ : First choice
☆ : Second choice

Designation	CW ^{+0.1}	RE	Coated	Cermet					INSL	h
			GH730	NS9530						
GF30	3	0.2	●	●					10	3.5
GF40	4	0.2	●	●					10	4
GF50	5	0.2	●	●					12	4.5

● : Line up

Reference pages: Toolholders → **F079 - F081**, Standard cutting conditions → **F090**

GN

For internal grooving

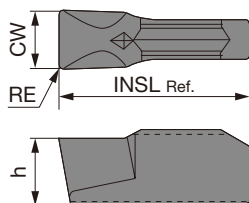

P	Steel	★								
M	Stainless	★								
K	Cast iron	☆								
N	Non-ferrous									
S	Superalloys									
H	Hard materials									

★ : First choice
☆ : Second choice

Designation	CW ₀ ^{+0.1}	RE	Coated							INSL	h
			GH730								
GN30	3	0.2	●							10	3.5
GN40	4	0.2	●							10	4
GN50	5	0.2	●							12	4.5

● : Line up

GE-R/L

For parting off (handed inserts)

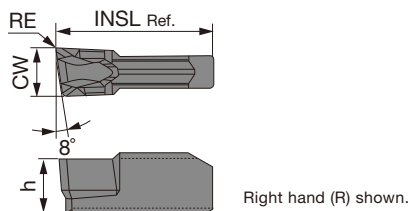

P	Steel	★	★							
M	Stainless	★	★							
K	Cast iron	★	☆							
N	Non-ferrous									
S	Superalloys	☆								
H	Hard materials									

★ : First choice
☆ : Second choice

Designation	HAND	CW ₀ ^{+0.1}	RE	Coated							INSL	h
				AH120	GH730							
GE30R	R	3	0.2	●	●						10	3.5
GE30L	L	3	0.2	●	●						10	3.5
GE40R	R	4	0.2	●	●						10	4
GE40L	L	4	0.2	●	●						10	4
GE50R	R	5	0.2	●	●						12	4.5
GE50L	L	5	0.2	●	●						12	4.5

● : Line up

Reference pages: Toolholders → **F079 - F081**, Standard cutting conditions → **F090**



GE-AL

For aluminium and non-ferrous metal

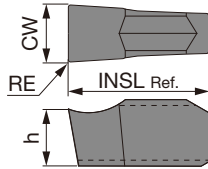

P	Steel									
M	Stainless									
K	Cast iron									
N	Non-ferrous	★								
S	Superalloys									
H	Hard materials									

★ : First choice
☆ : Second choice

Designation	CW ^{+0.1} ₀	RE	Uncoated							INSL	h
			KS05F								
GE20-AL	2	0.2	●							10	3.5
GE30-AL	3	0.2	●							10	3.5
GE40-AL	4	0.2	●							10	4

● : Line up

STANDARD CUTTING CONDITIONS (for 1 corner inserts)

ISO	Workpiece material	Grades	Cutting speed Vc (m/min)
P	Low carbon steel, Alloy steel (~ HB150)	T9225	80 - 300
		NS9530	100 - 200
		GH730, AH120	50 - 180
	Medium carbon steel, Alloy steel (HB150 ~ 250)	T9225	80 - 220
		NS9530	80 - 180
		GH730, AH120	50 - 150
High carbon steel, Alloy steel (HB250 ~)	T9225	80 - 220	
	NS9530	80 - 150	
	GH730, AH120	50 - 120	
M	Stainless steel	GH730, AH120	50 - 120
K	Grey iron, Ductile cast iron	GH730, AH120	50 - 180
N	Aluminium alloy, Non-ferrous metal	KS05F	200 - 300

For External

Operation	Feed: f (mm/rev)			
	Groove width: CW (mm)			
	2	3	4	5
Grooving (GE ^{**})	0.06 - 0.2	0.06 - 0.25	0.07 - 0.27	0.07 - 0.3
Parting off (GE ^{**} R/L)	0.04 - 0.1	0.04 - 0.14	0.04 - 0.14	0.04 - 0.14
Traversing (GT ^{**})	-	ap = 0.5 - 1.5 f = 0.06 - 0.2	ap = 0.5 - 2 f = 0.06 - 0.25	ap = 0.5 - 2.5 f = 0.06 - 0.27
Profiling (GR ^{**})	-	ap = 0.5 - 1.4 f = 0.05 - 0.25	ap = 0.5 - 1.5 f = 0.05 - 0.26	ap = 0.5 - 1.6 f = 0.05 - 0.3
Grooving for Aluminium alloys (GE ^{**} -AL)	0.03 - 0.1	0.03 - 0.1	0.03 - 0.1	-

For diameter compensation values in traversing, see page F115.

Reference pages: Toolholders → F079 - F081

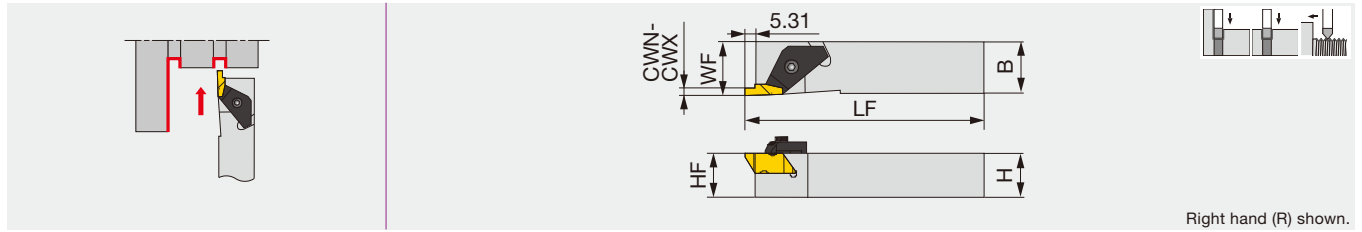

Designation	CWN	CWX	HF	H	B	LF	WF	Insert	Torque*
FLASR/L-1616M3	1	3	16	16	16	125	16	FL*-3**R/L...	3

Note: Use right-hand toolholders (R) with right-hand inserts (R); and left-hand toolholders (L) with left-hand inserts (L).
*Torque: Recommended clamping torque (N·m)

FLSR/L

External grooving and threading toolholder, for Swiss lathes

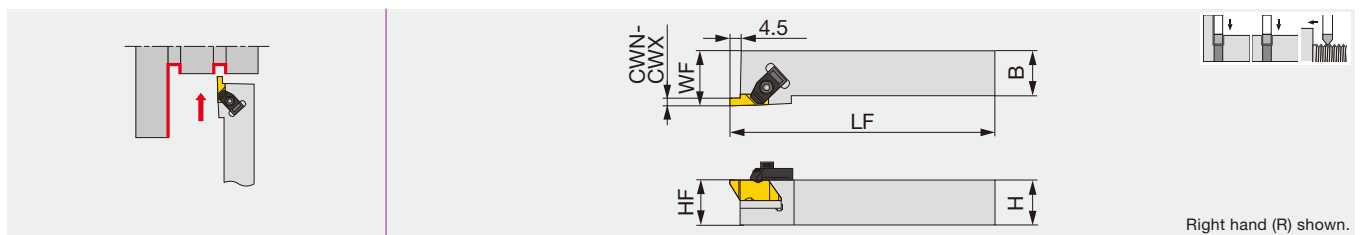

Designation	CWN	CWX	HF	H	B	LF	WF	Insert	Torque*
FLSR/L-2020M3	1	3	20	20	20	125	32	FL*-3**R/L...	3
FLSR/L-2525M3	1	3	25	25	25	150	32	FL*-3**R/L...	3

Note: Use right-hand toolholders (R) with right-hand inserts (R); and left-hand toolholders (L) with left-hand inserts (L).
*Torque: Recommended clamping torque (N·m)

SPARE PARTS

Designation	Clamp	Clamping screw	Wrench
FLASR-1616M3	TF-184	S-412	5/32HEX
FLASL-1616M3	TF-185	S-412	5/32HEX
FLSR-****M3	TF-72	S-412	5/32HEX
FLSL-****M3	TF-73	S-412	5/32HEX

INSERT

FLG-CB (For grooving)

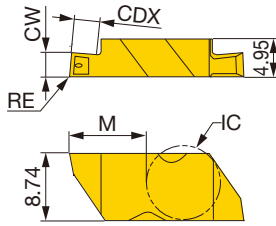

P	Steel	★						
M	Stainless	★						
K	Cast iron	★						
N	Non-ferrous							
S	Superalloys	☆						
H	Hard materials							

★ : First choice
☆ : Second choice

Designation	HAND	CW±0.025	RE	Coated						CDX	IC	M
				AH110								
FLG-3M100R-CB	R	1	0.19	●						1.4	9.525	10.3
FLG-3M100L-CB	L	1	0.19	●						1.4	9.525	10.3
FLG-3M150R-CB	R	1.5	0.19	●						2.55	9.525	10.3
FLG-3M150L-CB	L	1.5	0.19	●						2.55	9.525	10.3
FLG-3M200R-CB	R	2	0.19	●						2.55	9.525	10.3
FLG-3M200L-CB	L	2	0.19	●						2.55	9.525	10.3
FLG-3M250R-CB	R	2.5	0.19	●						4.07	9.525	10.3
FLG-3M250L-CB	L	2.5	0.19	●						4.07	9.525	10.3
FLG-3M300R-CB	R	3	0.19	●						4.07	9.525	10.3
FLG-3M300L-CB	L	3	0.19	●						4.07	9.525	10.3

● : Line up

STANDARD CUTTING CONDITIONS

ISO	Workpiece material	Grade	Application	Cutting speed Vc (m/min)	Feed f (mm/rev)
P	High carbon steel S45C, etc. C45, etc.	AH110	Grooving	100 - 200	0.12 - 0.35
	Alloy steel SCM435, etc. 34CrMo4, etc.	AH110	Grooving	50 - 80	0.12 - 0.3
M	Stainless steel SUS304, etc. X5CrNi18-9, etc.	AH110	Grooving	50 - 150	0.1 - 0.2
K	Gray cast iron FC250, etc. 250, etc.	AH110	Grooving	50 - 180	0.1 - 0.25
	Ductile cast iron FCD400, etc. 40-15, etc.	AH110	Grooving	50 - 120	0.1 - 0.25

Reference pages: Toolholders → **F091**

CER/L

External grooving and threading toolholder (The -DT holders can be used either with the insert screw or top-clamp)

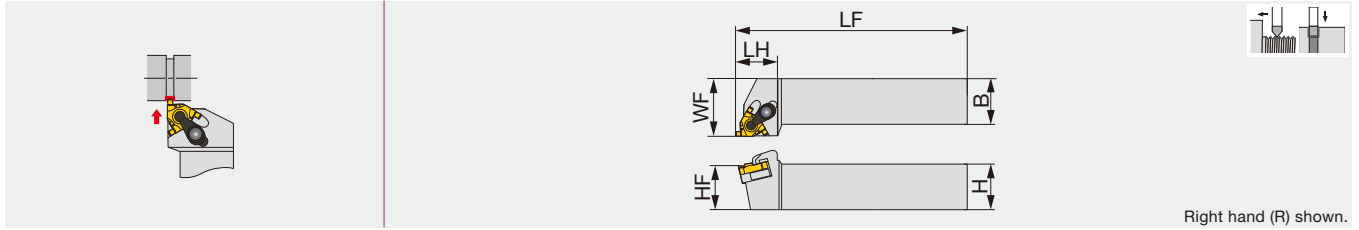

Designation	CWN	CWX	H	B	LF	LH	HF	WF	Insert	Torque*
CER/L1212H16DT	1	2.25	12	12	100	24	12	16	GTGN-16...	3.5
CER/L1616H16DT	1	2.25	16	16	100	24	16	20	GTGN-16...	3.5
CER/L2020K16DT	1	2.25	20	20	125	24	20	25	GTGN-16...	3.5
CER/L2525M16DT	1	2.25	25	25	150	28	25	32	GTGN-16...	3.5
CER3232P16T	1	2.25	32	32	170	32	32	40	GTGN-16...	3.5

Note: A clamp set consists of a clamp and a clamping screw. A shim set consists of a shim and a shim screw to secure the shim to the toolholder.

Standard shims can be used on both right- and left-hand toolholders. Please use either of the sides depending on the tool hand.

When using grooving inserts, please use shims for grooving. Shims for grooving inserts are sold separately.

Use right-hand toolholders (R) with right-hand inserts (R); and left-hand toolholders (L) with left-hand inserts (L).

*Torque: Recommended clamping torque (N·m)

SPARE PARTS

Designation	Clamp set	Clamp screw	Shim screw	*Optional: Shim for grooving	Wrench 1	Wrench 2
CER****16DT	CSP16	CSTB-3.5ST	DTS5-3.5	G16ER/IL-DT	P-3.5	T-15F
CEL****16DT	CSP16	CSTB-3.5ST	DTS5-3.5	G16EL/IR-DT	P-3.5	T-15F
CER3232P16T	CSP16	-	-	G16ER/IR-S	-	T-15F

B-CER/L

External threading and grooving toolholder, for Swiss lathes

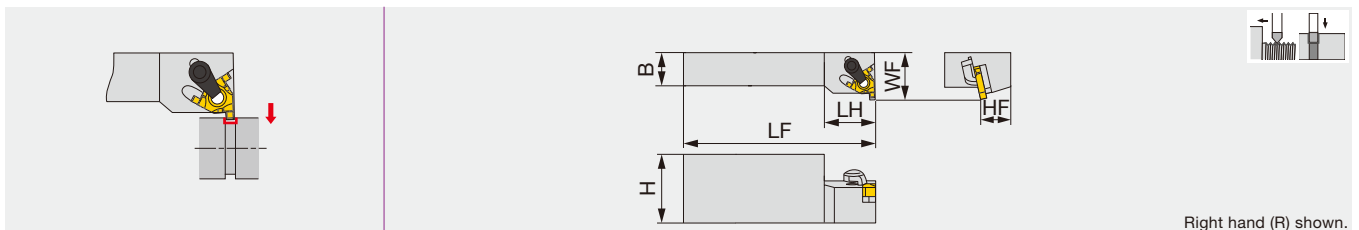

Designation	CWN	CWX	H	B	LF	LH	HF	WF	Insert	Torque*
B-CER/L16M16	1	2.25	32	16	150	24	16	22	GTGN-16...	3.5

Note: When using grooving inserts, please use shims for grooving. Shims for grooving inserts are sold separately.

Use right-hand toolholders (R) with right-hand inserts (R); and left-hand toolholders (L) with left-hand inserts (L).

*Torque: Recommended clamping torque (N·m)

SPARE PARTS

Designation	Clamp set	Clamp screw	Wrench	*Optional: Shim for grooving
B-CER16M16	CSP16	-	T-15F	G16ER/IL-S
B-CEL16M16	CSP16	-	T-15F	G16EL/IR-S

Reference pages: Inserts, Standard cutting conditions → **F094**

INSERT

GTGN16

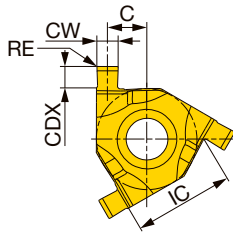

ER/IL shown.

P	Steel	★			
M	Stainless	★			
K	Cast iron				
N	Non-ferrous				
S	Superalloys	★			
H	Hard materials				

★ : First choice
☆ : Second choice



Designation	HAND (External)	CW±0.03	RE	Coated		Insert size	CDX	IC	C	Shim	
				SH730						Dual-clamp toolholder: screw-on and clamp-on	Clamp-on toolholder
GTGN-16ER/IL100	R	1	0.1	●		16	1.25	9.525	4.22	G16ER/IL-DT	G16ER/IL-S
GTGN-16EL/IR100	L	1	0.1	●		16	1.25	9.525	4.22	G16EL/IR-DT	G16EL/IR-S
GTGN-16ER/IL120	R	1.2	0.1	●		16	1.3	9.525	4.12	G16ER/IL-DT	G16ER/IL-S
GTGN-16EL/IR120	L	1.2	0.1	●		16	1.3	9.525	4.12	G16EL/IR-DT	G16EL/IR-S
GTGN-16ER/IL140	R	1.4	0.1	●		16	1.5	9.525	4.02	G16ER/IL-DT	G16ER/IL-S
GTGN-16EL/IR140	L	1.4	0.1	●		16	1.5	9.525	4.02	G16EL/IR-DT	G16EL/IR-S
GTGN-16ER/IL170	R	1.7	0.1	●		16	1.7	9.525	3.67	G16ER/IL-DT	G16ER/IL-S
GTGN-16EL/IR170	L	1.7	0.1	●		16	1.7	9.525	3.67	G16EL/IR-DT	G16EL/IR-S
GTGN-16ER/IL195	R	1.95	0.1	●		16	1.7	9.525	3.75	G16ER/IL-DT	G16ER/IL-S
GTGN-16EL/IR195	L	1.95	0.1	●		16	1.7	9.525	3.75	G16EL/IR-DT	G16EL/IR-S
GTGN-16ER/IL225	R	2.25	0.1	●		16	1.8	9.525	3.6	G16ER/IL-DT	G16ER/IL-S
GTGN-16EL/IR225	L	2.25	0.1	●		16	1.8	9.525	3.6	G16EL/IR-DT	G16EL/IR-S

Note: GTGN insert can be used for both external and internal machining, but the tool hand is reversed.
Shim for GTGN depends on the toolholder type.

● : Line up

STANDARD CUTTING CONDITIONS

ISO	Workpiece material	Grade	Cutting speed Vc (m/min)	Feed f (mm/rev)
P	Steels S45C, SCM440 etc. C45, 42CrMo4, etc.	SH730	50 - 150	0.05 - 0.1
M	Stainless steels SUS304, SUS316 etc. X5CrNi18-9, X5CrNiMo17-12-2, etc.	SH730	30 - 120	0.05 - 0.1
S	Heat-resistant alloys, Titanium alloys etc. Ti-6Al-4V, etc.	SH730	30 - 40	0.05 - 0.1

Reference pages: Toolholders → **F093**

External grooving toolholder

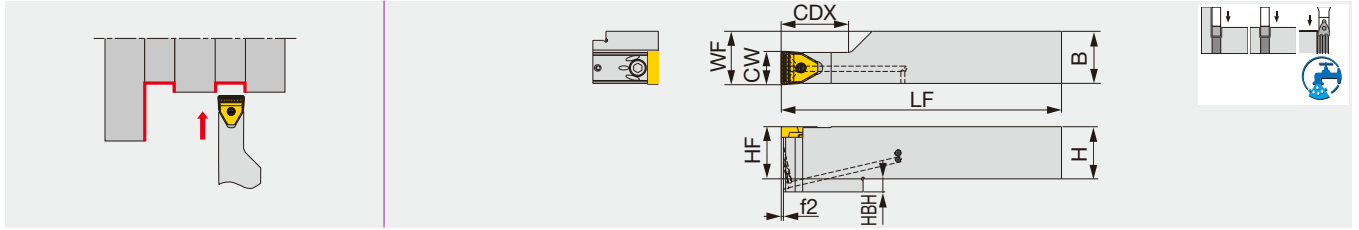

Designation	CW	CDX	H	B	LF	HF	WF	HBH	f2	Insert ⁽¹⁾	Torque*
FPGR2525M-10T20	10	20	25	25	150	25	25.5	-	0.5	PSG*10...	2.2
FPGR3232P-10T36	10	36	32	32	170	32	32.5	-	0.5	PSG*10...	2.2
FPGR2525M-15T20	15	20	25	25	150	25	25.5	-	0.5	PSG*15...	2.2
FPGR3232P-15T40	15	40	32	32	170	32	32.5	-	0.4	PSG*15...	2.2
FPGR3232P-20T40	20	40	32	32	170	32	32.5	8	0.4	PSG*20...	8.5
FPGR4040R-20T50	20	50	40	40	200	40	40.5	8	0.4	PSG*20...	8.5
FPGR3232P-25T40	25	40	32	32	170	32	32.5	8	0.4	PSG*25...	8.5
FPGR4040R-25T50	25	50	40	40	200	40	40.5	8	0.4	PSG*25...	8.5

(1) Can be used for both wide grooving and wide profile grooving
 *Torque: Recommended clamping torque (N·m)

CDX, LF, f2 are dimensions when PSGM insert is attached. When mounting PSGB insert, the dimensions will be 5 mm longer.

FPGN

External profile grooving toolholder

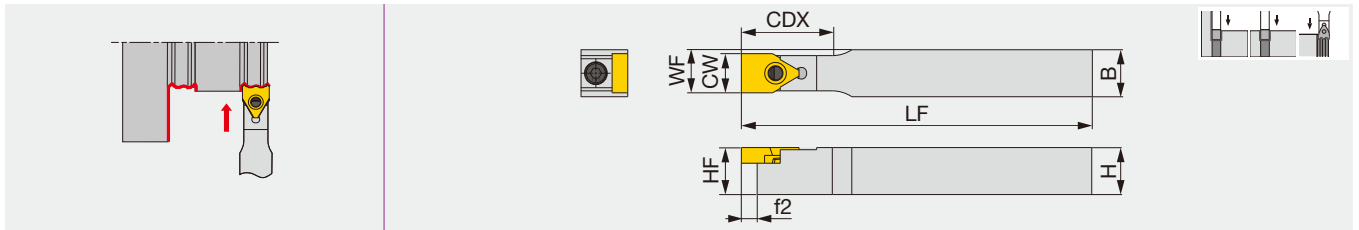

Designation	CW	CDX	H	B	LF	HF	WF	f2	Insert ⁽¹⁾	Torque*
FPGN1212X-10T20	10	25	12	12	125	12	11	5.5	PSG*10...	2.2
FPGN1616X-10T20	10	25	16	16	125	16	13	5.5	PSG*10...	2.2
FPGN2020K-10T20	10	25	20	20	130	20	15	5.5	PSG*10...	2.2
FPGN1616X-15T25	15	30	16	16	125	16	15.5	5.5	PSG*15...	2.2
FPGN2020K-15T25	15	30	20	20	130	20	17.5	5.5	PSG*15...	2.2
FPGN2020K-20T32	20	37	20	20	130	20	20	5.5	PSG*20...	8.5
FPGN2525M-20T32	20	37	25	25	155	25	22.5	5.5	PSG*20...	8.5
FPGN2525M-25T36	25	41	25	25	155	25	25	5.5	PSG*25...	8.5

*PSGB insert blank is available for tailored inserts.

(1) Can be used for both wide grooving and wide profile grooving

*Torque: Recommended clamping torque (N·m)

CDX, LF, f2 are dimensions when PSGB insert is attached. When mounting PSGM insert, the dimensions will be 5 mm shorter.

SPARE PARTS

Designation	Lever	Clamping screw	Spring	Wrench
FPG*****-10T..., 15T...	FCL4	FCS3	BP-5	P-2.5
FPG*****-20T..., 25T...	FCL8	FCS6	BP-9	P-5



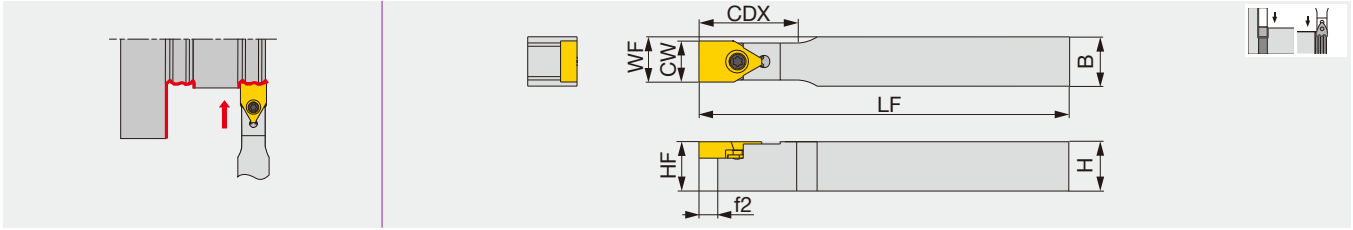



Designation	CW	CDX	H	B	LF	HF	WF	f2	Insert (1)	Torque*
SPGN1212X-10T20	10	25	12	12	125	12	11	5.5	PSGB10	1.3
SPGN1616X-10T20	10	25	16	16	125	16	13	5.5	PSGB10	1.3
SPGN2020K-10T20	10	25	20	20	130	20	15	5.5	PSGB10	1.3
SPGN1616X-15T25	15	30	16	16	125	16	15.5	5.5	PSGB15	3.5
SPGN2020K-15T25	15	30	20	20	130	20	17.5	5.5	PSGB15	3.5
SPGN2020K-20T32	20	37	20	20	130	20	20	5.5	PSGB20	5
SPGN2525M-20T32	20	37	25	25	155	25	22.5	5.5	PSGB20	5
SPGN2525M-25T36	25	41	25	25	155	25	25	5.5	PSGB25	5

*PSGB insert blank is available for tailored inserts.
*Torque: Recommended clamping torque (N·m)

SPARE PARTS

Designation	Clamping screw	Wrench
SPGN*****-10T20	CSTB-3L081	T-8F
SPGN*****-15T25	CSTB-4	T-15F
SPGN*****-20T..., 25T...	CSTB-5	T-20F

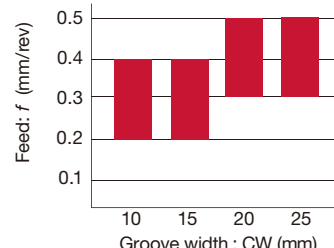
CHIPBREAKER GUIDE

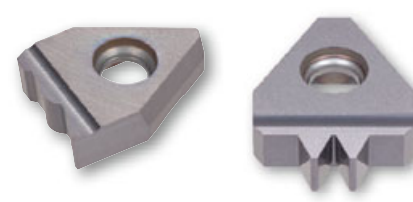
<p>PSGM</p> 	<p>For wide grooving Improved productivity with excellent chip control and the chipbreaker designed for high feed</p> <p>CW = 10 - 25 mm</p>	
<p>PSGB</p> 	<p>Blank for wide profile grooving inserts Can be prepared for various insert shapes Shortened cutting time and improved productivity with one-pass operations</p> <p>CW = 10 - 25 mm</p>	<p>Specially tailored inserts (example)</p> 

Reference pages: Standard cutting conditions → **F098**

INSERTS

PSGM

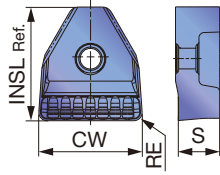

P	Steel	★						
M	Stainless	★						
K	Cast iron	☆						
N	Non-ferrous							
S	Superalloys							
H	Hard materials							

★ : First choice
☆ : Second choice

Designation	CW*	RE	Coated						INSL	S
			AH725							
PSGM10-08	10	0.8	●						11	4
PSGM15-15	15	1.5	●						15	5
PSGM20-20	20	2	●						22	6.5
PSGM25-20	25	2	●						22	6.5

*Tolerance: CW ± 0.08 (CW = 10 mm), ± 0.1 (CW ≥ 15 mm)

● : Line up

PSGB

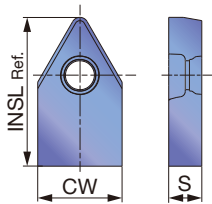

P	Steel	☆	★						
M	Stainless		★						
K	Cast iron	★							
N	Non-ferrous	★							
S	Superalloys	☆							
H	Hard materials								

★ : First choice
☆ : Second choice

Designation	CW±0.025	Uncoated						INSL	S
		TH10	UX30						
PSGB10	10.2	●	●					18	4
PSGB15	15.2	●	●					20	5
PSGB20	20.2	●	●					27	6.5
PSGB25	25.2	●	●					27	6.5

● : Line up

Reference pages: Toolholders → **F095, F096**, Standard cutting conditions → **F098**

STANDARD CUTTING CONDITIONS

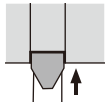

Wide grooving (PSGM insert)

ISO	Workpiece material	Hardness (HB)	Grade	Cutting Speed Vc (m/min)
P	Alloy steel SCM440, etc. 42CrMo4, etc.	< 300	AH725	50 - 180
Groove width: CW (mm)				
	10	15	20	25
Feed: f (mm/rev)	0.2 - 0.4	0.2 - 0.4	0.3 - 0.5	0.3 - 0.5

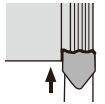

Wide profile grooving (PSGB insert)

ISO	Workpiece material	Hardness (HB)	Grade	Cutting Speed Vc (m/min)
P	Carbon steel S45C, etc. C45, etc.	< 200	UX30	50 - 150
	Alloy steel SCM440, etc. 42CrMo4, etc.	< 300	UX30	50 - 120
M	Stainless steel SUS303, etc. X10CrNiS18-9, etc.	< 200	UX30	50 - 120
K	Grey cast iron FC250, etc. 250, etc.	-	TH10	50 - 150
	Ductile cast irons FCD450, etc. 450-10S, etc.	-	TH10	50 - 120
N	Aluminium alloy Si < 12%, etc.	-	TH10	100 - 500

■ Spare parts for internal coolant supply attachment (Order separately)

No.	Parts name	Designation	Note
①	Body	FPGR...	-
②	Insert	PSGM...	-
③	Coolant supply attachment	SGCU-341	-
④	Connector	Commercial items can be used	G 1/8 thread
			NPT 1/8 thread

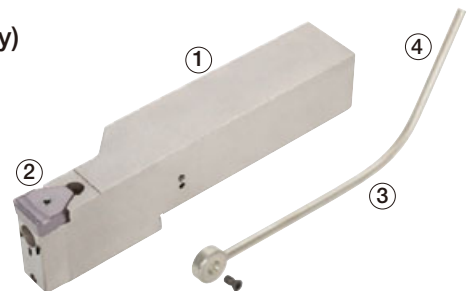

TGTSR/L

External grooving toolholder, for 3 corner insert

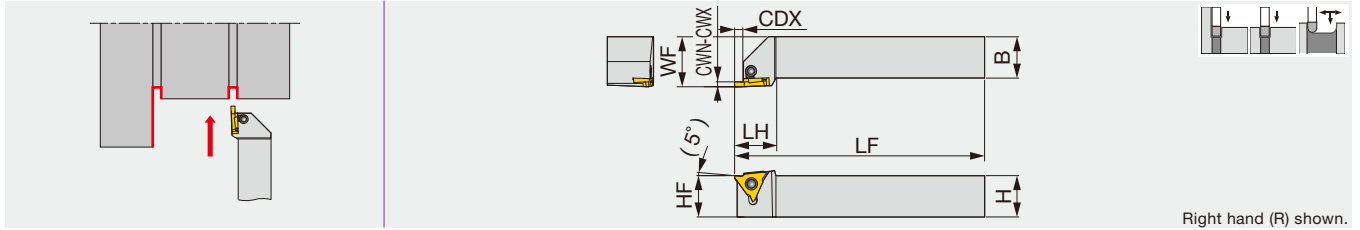

Right hand (R) shown.

Designation	CWN	CWX	CDX	H	B	LF	LH	HF	WF	Torque*
TGTSR/L2020K16	0.33	2.5	2.5	20	20	125	25	20	25	3
TGTSR/L2525M16	0.33	2.5	2.5	25	25	150	25	25	30	3
TGTSR/L2020K22-1	1	1.45	2	20	20	125	25	20	25	3
TGTSR/L2020K22-2	1.5	2.3	3.5	20	20	125	25	20	25	3
TGTSR/L2020K22-3	2.5	4.5	5	20	20	125	25	20	25	3
TGTSR/L2525M22-1	1	1.45	2	25	25	150	25	25	30	3
TGTSR/L2525M22-2	1.5	2.3	3.5	25	25	150	25	25	30	3
TGTSR/L2525M22-3	2.5	4.5	5	25	25	150	25	25	30	3

Use right-hand toolholders (TGTSR) with right-hand inserts (GBR); and left-hand toolholders (TGTSL) with left-hand inserts (GBL).
*Torque: Recommended clamping torque (N·m)

Designation	Insert
TGTSR/L2020K16	GBR/L32...
TGTSR/L2525M16	GBR/L32...
TGTSR/L2020K22-1	GBR/L43125 ~ 145 GBR/L43050R
TGTSR/L2020K22-2	GBR/L43150 ~ 230 GBR/L43075R ~ 100R
TGTSR/L2020K22-3	GBR/L43250 ~ 450 GBR/L43125R ~ 200R
TGTSR/L2525M22-1	GBR/L43125 ~ 145 GBR/L43050R
TGTSR/L2525M22-2	GBR/L43150 ~ 230 GBR/L43075R ~ 100R
TGTSR/L2525M22-3	GBR/L43250 ~ 450 GBR/L43125R ~ 200R

SPARE PARTS

Designation	Clamp	Clamping screw	Wrench
TGTSR/L****16	CP900	MCS520-2.5	P-2.5
TGTSR/L****22...	CP910	MCS520-2.5	P-2.5

TGTTR/L

External grooving with tangential pocket, for 3 corner insert

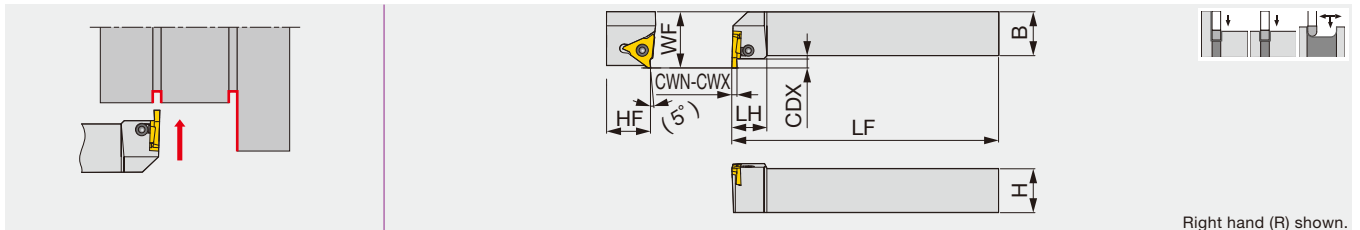

Right hand (R) shown.

Designation	CWN	CWX	CDX	H	B	LF	LH	HF	WF	Torque*
TGTTR/L2020K16	0.33	2.5	2.5	20	20	125	20	20	27	3
TGTTR/L2525M16	0.33	2.5	2.5	25	25	150	20	25	32	3
TGTTR/L2020K22-1	1	1.45	2	20	20	125	20	20	27	3
TGTTR/L2020K22-2	1.5	2.3	3.5	20	20	125	20	20	27	3
TGTTR/L2020K22-3	2.5	4.5	5	20	20	125	20	20	27	3
TGTTR/L2525M22-1	1	2.3	2	25	25	150	20	25	32	3
TGTTR/L2525M22-2	1.5	2.3	3.5	25	25	150	20	25	32	3
TGTTR/L2525M22-3	2.5	4.5	5	25	25	150	20	25	32	3

Use right-hand toolholders (TGTTR) with left-hand inserts (GBL); and left-hand toolholders (TGTTL) with right-hand inserts (GBR).
*Torque: Recommended clamping torque (N·m)

Designation	Insert
TGTTR/L2020K16	GBL/R32...
TGTTR/L2525M16	GBL/R32...
TGTTR/L2020K22-1	GBL/R43125 ~ 145 GBL/R43050R
TGTTR/L2020K22-2	GBL/R43150 ~ 230 GBL/R43075R ~ 100R
TGTTR/L2020K22-3	GBL/R43250 ~ 450 GBL/R43125R ~ 200R
TGTTR/L2525M22-1	GBL/R43125 ~ 145 GBL/R43050R
TGTTR/L2525M22-2	GBL/R43150 ~ 230 GBL/R43075R ~ 100R
TGTTR/L2525M22-3	GBL/R43250 ~ 450 GBL/R43125R ~ 200R

SPARE PARTS

Designation	Clamp	Clamping screw	Wrench
TGTTR/L****16	CP900	MCS520-2.5	P-2.5
TGTTR/L****22...	CP910	MCS520-2.5	P-2.5

Reference pages: Inserts → **F100 - F102**, Standard cutting conditions → **F102**

INSERTS

GBR/L32

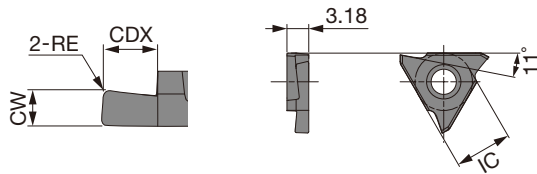

Right hand (R) shown.

P	Steel	★		★						
M	Stainless	★								
K	Cast iron	★		☆						
N	Non-ferrous					★				
S	Superalloys	☆				☆				
H	Hard materials									

★ : First choice
☆ : Second choice

Designation	HAND	CW±0.025	RE	Coated			Cermet			Uncoated			CDX	IC
				AH710			NS9530			KS05F				
GBR32033	R	0.33	0.03	●			●			●			0.8	9.53
GBL32033	L	0.33	0.03	●									0.8	9.53
GBR32050	R	0.5	0.05	●			●			●			1.2	9.53
GBL32050	L	0.5	0.05	●									1.2	9.53
GBR32075	R	0.75	0.05	●			●			●			2	9.53
GBL32075	L	0.75	0.05	●			●						2	9.53
GBR32095	R	0.95	0.05	●			●			●			2	9.53
GBL32095	L	0.95	0.05	●			●						2	9.53
GBR32100	R	1	0.05	●			●			●			2	9.53
GBL32100	L	1	0.05	●			●						2	9.53
GBR32125	R	1.25	0.2	●			●			●			2	9.53
GBL32125	L	1.25	0.2	●			●						2	9.53
GBR32145	R	1.45	0.2	●			●			●			2	9.53
GBL32145	L	1.45	0.2	●									2	9.53
GBR32150	R	1.5	0.2	●			●			●			2	9.53
GBL32150	L	1.5	0.2	●									2	9.53
GBR32200	R	2	0.2	●			●			●			2.5	9.53
GBL32200	L	2	0.2	●									2.5	9.53
GBR32250	R	2.5	0.2	●			●			●			2.5	9.53
GBL32250	L	2.5	0.2	●									2.5	9.53

● : Line up

Reference pages: Toolholders → **F099**, Standard cutting conditions → **F102**

GBR/L43

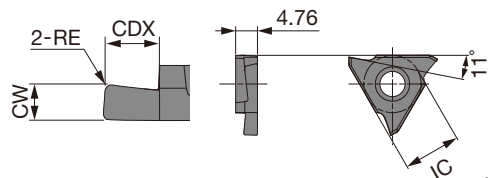

Right hand (R) shown.

P	Steel	★		★									
M	Stainless	★											
K	Cast iron	★		☆									
N	Non-ferrous							★					
S	Superalloys	☆						☆					
H	Hard materials												

★ : First choice
☆ : Second choice

Designation	HAND	CW±0.025	RE	Coated			Cermet			Uncoated			CDX	IC
				AH710			NS9530			KS05F				
GBR43125	R	1.25	0.2	●			●			●			2	12.7
GBL43125	L	1.25	0.2	●									2	12.7
GBR43145	R	1.45	0.2	●			●			●			2	12.7
GBL43145	L	1.45	0.2	●									2	12.7
GBR43150	R	1.50	0.2	●			●			●			3.5	12.7
GBL43150	L	1.50	0.2	●			●						3.5	12.7
GBR43175	R	1.75	0.2	●			●			●			3.5	12.7
GBL43175	L	1.75	0.2	●			●						3.5	12.7
GBR43185	R	1.85	0.2	●			●			●			3.5	12.7
GBL43185	L	1.85	0.2	●			●						3.5	12.7
GBR43200	R	2	0.2	●			●			●			3.5	12.7
GBL43200	L	2	0.2	●			●						3.5	12.7
GBR43230	R	2.3	0.2	●			●			●			3.5	12.7
GBL43230	L	2.3	0.2	●			●						3.5	12.7
GBR43250	R	2.5	0.3	●			●			●			5	12.7
GBL43250	L	2.5	0.3	●									5	12.7
GBR43265	R	2.65	0.3	●			●			●			5	12.7
GBL43265	L	2.65	0.3	●									5	12.7
GBR43280	R	2.8	0.3	●			●			●			5	12.7
GBL43280	L	2.8	0.3	●									5	12.7
GBR43300	R	3	0.3	●			●			●			5	12.7
GBL43300	L	3	0.3	●									5	12.7
GBR43330	R	3.3	0.3	●			●			●			5	12.7
GBL43330	L	3.3	0.3	●									5	12.7
GBR43350	R	3.5	0.3	●			●			●			5	12.7
GBL43350	L	3.5	0.3	●									5	12.7
GBR43400	R	4	0.4	●			●			●			5	12.7
GBL43400	L	4	0.4	●									5	12.7
GBR43430	R	4.3	0.4	●			●			●			5	12.7
GBL43430	L	4.3	0.4	●									5	12.7
GBR43450	R	4.5	0.4	●			●			●			5	12.7
GBL43450	L	4.5	0.4	●									5	12.7

● : Line up

Grade **A**
 Insert **B**
 Ext. Toolholder **C**
 Int. Toolholder **D**
 Threading **E**
 Grooving **F**
 Miniature tool **G**
 Milling cutter **H**
 Endmill **I**
 Drilling tool **J**
 Tooling System **K**
 User's Guide **L**
 Index **M**

GBR/L43-R(full radius)

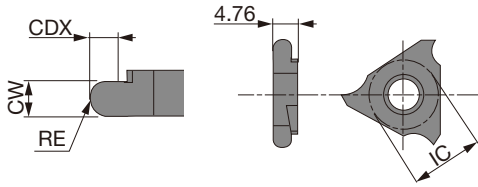

Right hand (R) shown.

P	Steel	★		★							
M	Stainless	★									
K	Cast iron	★		☆							
N	Non-ferrous							★			
S	Superalloys	☆						☆			
H	Hard materials										

★ : First choice
☆ : Second choice

Designation	HAND	CW±0.025	RE	Coated			Cermet			Uncoated			CDX	IC
				AH710	NS9530	KS05F								
GBR43050R	R	1	0.5	●	●	●							2	12.7
GBL43050R	L	1	0.5	●			●						2	12.7
GBR43075R	R	1.5	0.75	●	●	●							3.5	12.7
GBL43075R	L	1.5	0.75	●			●						3.5	12.7
GBR43100R	R	2	1	●	●	●							3.5	12.7
GBL43100R	L	2	1	●			●						3.5	12.7
GBR43125R	R	2.5	1.25	●	●	●							5	12.7
GBL43125R	L	2.5	1.25	●			●						5	12.7
GBR43150R	R	3	1.5	●	●	●							5	12.7
GBL43150R	L	3	1.5	●			●						5	12.7
GBR43200R	R	4	2	●	●	●							5	12.7
GBL43200R	L	4	2	●			●						5	12.7

● : Line up

STANDARD CUTTING CONDITIONS

ISO	Workpiece material	Hardness	Grade	Cutting Speed Vc (m/min)	Feed f (mm/rev)
P	Carbon steels, Alloy steels S45C, SCM415, etc. C45, 18CrMo4, etc.	150 - 240HB	NS9530	100 - 200	0.02 - 0.25
		150 - 240HB	AH710	60 - 150	0.05 - 0.25
M	Stainless steel SUS304, etc. X5CrNi18-9, etc.	≤ 240HB	AH710	60 - 150	0.05 - 0.15
K	Cast irons FC250, etc. 250, etc.	Tensile strength ≤ 350 N/mm ²	AH710	60 - 150	0.05 - 0.15
N	Non-ferrous metal Aluminum, etc.	-	KS05F	200 - 300	0.05 - 0.15

Reference pages: Toolholders → **F099**

SGTR/L

External grooving toolholder, for 3 corner inserts

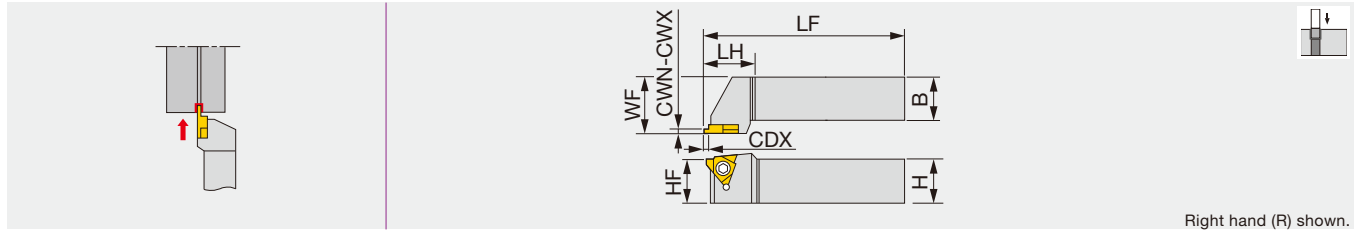

Designation	CWN	CWX	CDX	H	B	LF	LH	HF	WF	Insert	Torque*
SGTR1616-3	1.15	2.7	1.5 - 3	16	16	100	20	16	20	GLR/L3...	3.5
SGTR/L2020-3	1.15	2.7	1.5 - 3	20	20	125	20	20	25	GLR/L3...	3.5
SGTR/L2525-3	1.15	2.7	1.5 - 3	25	25	150	20	25	32	GLR/L3...	3.5
SGTR/L2020-4	1.15	4.2	1.5 - 4	20	20	125	30	20	25	GLR/L4...,GOR/L4...	5
SGTR/L2525-4	1.15	4.2	1.5 - 4	25	25	150	30	25	32	GLR/L4...,GOR/L4...	5

*Torque: Recommended clamping torque (N·m)

SPARE PARTS

Designation	Clamping screw	Wrench
SGTR/L****-3	CSTB-4	T-15F
SGTR/L****-4	CSTB-5	T-20F

INSERTS

GOR/L (For O-ring)

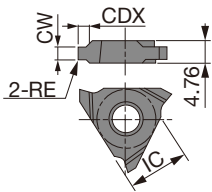

Right hand (R) shown.

P	Steel	★			★					
M	Stainless				★					
K	Cast iron	☆								
N	Non-ferrous									
S	Superalloys									
H	Hard materials									

★ : First choice
☆ : Second choice

Designation	HAND	CW ^{+0.1} _{+0.05}	RE	Cermets		Uncoated					CDX	IC	
				NS9530	UX30								
GOR4190	R	2.5	0.4	●	●							1.5	12.7
GOR4240	R	3.2	0.4	●	●							2	12.7
GOR4310	R	4.1	0.7	●	●							2.5	12.7

● : Line up

Reference pages: Inserts → **F103, F104**, Standard cutting conditions → **F104**



GLR/L (For lock ring)

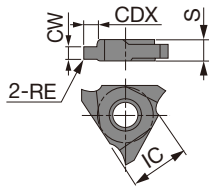

Right hand (R) shown.

P	Steel	★		★				
M	Stainless			★				
K	Cast iron	☆						
N	Non-ferrous							
S	Superalloys							
H	Hard materials							

★ : First choice
☆ : Second choice

Designation	HAND	CW ^{+0.1} _{+0.05}	RE	Cermet		Uncoated		CDX	IC	S
				NS9530	UX30					
GLR3115	R	1.15	0.1	●	●			1.5	9.53	3.18
GLL3115	L	1.15	0.1	●	●			1.5	9.53	3.18
GLR3135	R	1.35	0.1	●	●			1.5	9.53	3.18
GLL3135	L	1.35	0.1	●	●			1.5	9.53	3.18
GLR3165	R	1.65	0.1	●	●			2	9.53	3.18
GLR3175	R	1.75	0.1	●	●			2	9.53	3.18
GLL3175	L	1.75	0.1	●	●			2	9.53	3.18
GLR3195	R	1.95	0.1	●	●			2.5	9.53	3.18
GLL3195	L	1.95	0.1	●	●			2.5	9.53	3.18
GLR3220	R	2.2	0.1	●	●			3	9.53	3.18
GLL3220	L	2.2	0.1	●	●			3	9.53	3.18
GLR3270	R	2.7	0.1	●	●			3	9.53	3.18
GLL3270	L	2.7	0.1	●	●			3	9.53	3.18
GLR4115	R	1.15	0.1	●	●			1.5	12.7	4.76
GLR4135	R	1.35	0.1	●	●			1.5	12.7	4.76
GLR4165	R	1.65	0.1	●	●			2	12.7	4.76
GLR4175	R	1.75	0.1	●	●			2	12.7	4.76
GLR4190	R	1.9	0.1	●	●			2.5	12.7	4.76
GLR4195	R	1.95	0.1	●	●			2.5	12.7	4.76
GLR4220	R	2.2	0.1	●	●			3.5	12.7	4.76
GLL4220	L	2.2	0.1	●	●			3.5	12.7	4.76
GLR4270	R	2.7	0.1	●	●			3.5	12.7	4.76
GLR4320	R	3.2	0.1	●	●			4	12.7	4.76
GLL4320	L	3.2	0.1	●	●			4	12.7	4.76
GLR4420	R	4.2	0.1	●	●			4	12.7	4.76
GLL4420	L	4.2	0.1	●	●			4	12.7	4.76

● : Line up

STANDARD CUTTING CONDITIONS

ISO	Workpiece material	Grade	Cutting Speed V _c (m/min)	Feed: f (mm/rev)		
				CW < 2 mm	CW = 2 ~ 4 mm	CW > 4 mm
P	Carbon steel	NS9530	80 - 200	0.05 - 0.1	0.08 - 0.2	0.08 - 0.25
		UX30	60 - 150	0.05 - 0.1	0.08 - 0.2	0.08 - 0.25

Reference pages: Toolholders → **F103**

GX-R/LE

External grooving toolholder, for 2 corner inserts

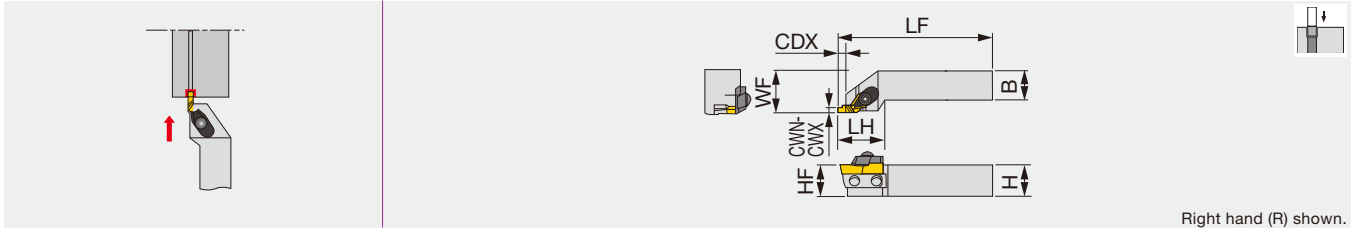

Designation	CWN	CWX	CDX	H	B	LF	LH	HF	WF	Insert	Torque*
GX-2020R/LE	1	4.5	1.5 - 6	20	20	125	40	20	25	XGR/L63...	5
GX-2525R/LE	1	4.5	1.5 - 6	25	25	150	38	25	32	XGR/L63...	5

Use right-hand toolholders (GX-****RE) with right-hand inserts (XGR...); and left-hand toolholders (GX-****LE) with left-hand inserts (XGL...).

*Torque: Recommended clamping torque (N·m)

SPARE PARTS

Designation	Clamp set	Clamp screw	Shim	Shim screw	Wrench
GX-2020RE	CP81A	RT-1	SL-6R	BHM4-8	P-4
GX-2020LE	CP81A	RT-1	SL-6L	BHM4-8	P-4
GX-2525RE	CP81A	RT-1	SL-1R	BHM4-8	P-4
GX-2525LE	CP81A	RT-1	SL-1L	BHM4-8	P-4

Note: Max. groove width and max. groove depth will depend on the insert type.

INSERTS

XGR/L

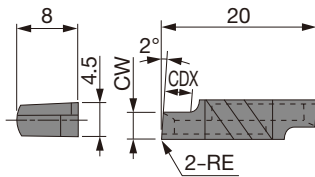

Right hand (R) shown.

P Steel	★			☆	★					
M Stainless					★					
K Cast iron	☆			★						
N Non-ferrous				★						
S Superalloys				☆						
H Hard materials										

★ : First choice
☆ : Second choice

Designation	HAND	CW±0.025	RE	Cermet		Uncoated		CDX
				NS9530	TH10	UX30		
XGR6310-02	R	1	0.2	●	●	●		1.5
XGL6310-02	L	1	0.2	●	●	●		1.5
XGR6315-02	R	1.5	0.2	●	●	●		2.3
XGL6315-02	L	1.5	0.2	●	●	●		2.3
XGR6320-02	R	2	0.2	●	●	●		3
XGL6320-02	L	2	0.2	●	●	●		3
XGR6325-02	R	2.5	0.2	●	●	●		3.8
XGL6325-02	L	2.5	0.2	●	●	●		3.8
XGR6330-02	R	3	0.2	●	●	●		4.5
XGL6330-02	L	3	0.2	●	●	●		4.5
XGR6335-02	R	3.5	0.2	●	●	●		5.3
XGL6335-02	L	3.5	0.2	●	●	●		5.3
XGR6340-02	R	4	0.2	●	●	●		6
XGL6340-02	L	4	0.2	●	●	●		6
XGR6345-02	R	4.5	0.2	●	●	●		6
XGL6345-02	L	4.5	0.2	●	●	●		6

Use right-hand toolholders (GX-****RE) with right-hand inserts (XGR...)
left-hand toolholders (GX-****LE) with left-hand inserts (XGL...).

● : Line up

Reference pages: Inserts → **F105, F106**, Standard cutting conditions → **F106**



XGR/L-QBN

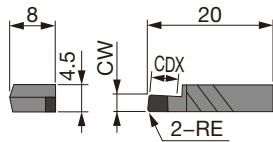

Right hand (R) shown.

P	Steel									
M	Stainless									
K	Cast iron									
N	Non-ferrous									
S	Superalloys									
H	Hard materials	★								☆ : First choice ☆ : Second choice

Designation	HAND	CW±0.05	RE	CBN							CDX
				BX360							
XGL6310S-QBN	L	1	0.2	●							1.5
XGR6315S-QBN	R	1.5	0.2	●							2.3
XGL6315S-QBN	L	1.5	0.2	●							2.3
XGR6320S-QBN	R	2	0.2	●							3
XGL6320S-QBN	L	2	0.2	●							3
XGR6325S-QBN	R	2.5	0.2	●							3.8
XGL6325S-QBN	L	2.5	0.2	●							3.8
XGR6330S-QBN	R	3	0.2	●							4.5
XGL6330S-QBN	L	3	0.2	●							4.5
XGR6335S-QBN	R	3.5	0.2	●							5.3
XGL6335S-QBN	L	3.5	0.2	●							5.3
XGR6340S-QBN	R	4	0.2	●							6
XGL6340S-QBN	L	4	0.2	●							6
XGR6345S-QBN	R	4.5	0.2	●							6
XGL6345S-QBN	L	4.5	0.2	●							6

Use right-hand toolholders (GX-****RE) with right-hand inserts (XGR...)
left-hand toolholders (GX-****LE) with left-hand inserts (XGL...).

● : Line up

STANDARD CUTTING CONDITIONS

ISO	Workpiece material	Grade	Cutting Speed Vc (m/min)	Feed: f (mm/rev)		
				CW < 2 mm	CW = 2 ~ 4 mm	CW > 4 mm
P	Carbon steel	NS9530	80 - 200	0.05 - 0.1	0.08 - 0.2	0.08 - 0.25
		UX30	60 - 150	0.05 - 0.1	0.08 - 0.2	0.08 - 0.25
K	Cast irons , Light alloys	TH10	60 - 150	0.05 - 0.1	0.08 - 0.2	0.08 - 0.25
H	Hardened steels	BX360	50 - 180	0.05 - 0.15	0.05 - 0.15	0.05 - 0.15

Reference pages: Toolholders → **F105**

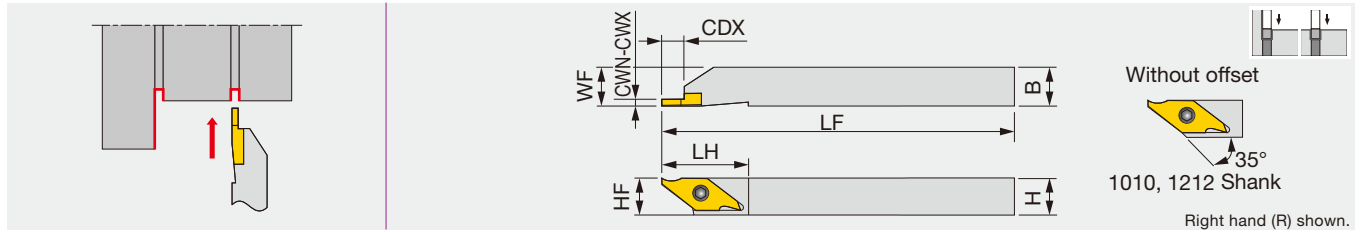

Designation	CWN	CWX	CDX	H	B	LF	LH	HF	WF	Insert	Torque*
JSVGRL1010K-C	0.33	2	0.7 - 5.5	10	10	125	23	10	10	JVGR/L...	2.3
JSVGRL1212K-C	0.33	2	0.7 - 5.5	12	12	125	23	12	12	JVGR/L...	2.3
JSVGRL1616K	0.33	2	0.7 - 5.5	16	16	125	23	16	16	JVGR/L...	2.3

*Torque: Recommended clamping torque (N·m)

SPARE PARTS

Designation	Clamping screw	Wrench 1	Wrench 2 (Optional)
JSVGRL/...	CSTB-3S	T-9F	(T-9L)

INSERT

JVG (with hand, sharp edge)

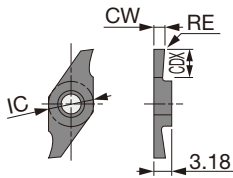

Right hand (R) shown.

	P	M	K	N	S	H
Steel	★	★				★
Stainless	★	★				
Cast iron					☆	
Non-ferrous					★	
Superalloys					★	
Hard materials						

★ : First choice
☆ : Second choice

Designation	HAND	CW ^{+0.05}	RE	Coated		Cermet	Uncoated		CDX	IC
				SH725	J740	NS9530	TH10			
JVGR033F	R	0.33	0	●	●			●	0.7	7.94
JVGL033F	L	0.33	0	●	●			●	0.7	7.94
JVGR050F	R	0.5	0	●	●			●	1.1	7.94
JVGL050F	L	0.5	0	●	●			●	1.1	7.94
JVGR075F	R	0.75	0	●	●			●	1.9	7.94
JVGL075F	L	0.75	0	●	●			●	1.9	7.94
JVGR095F	R	0.95	0	●	●			●	1.9	7.94
JVGL095F	L	0.95	0	●	●			●	1.9	7.94
JVGR100F	R	1	0	●	●	●		●	5.5	7.94
JVGL100F	L	1	0	●	●	●		●	5.5	7.94
JVGR125F	R	1.25	0	●	●			●	5	7.94
JVGL125F	L	1.25	0	●	●			●	5	7.94
JVGR150F	R	1.5	0	●	●	●		●	5.5	7.94
JVGL150F	L	1.5	0	●	●	●		●	5.5	7.94
JVGR200F	R	2	0	●	●	●		●	5.5	7.94
JVGL200F	L	2	0	●	●	●		●	5.5	7.94

● : Line up



Screw-on toolholder for front turning, reverse turning, and external grooving, for Swiss lathes

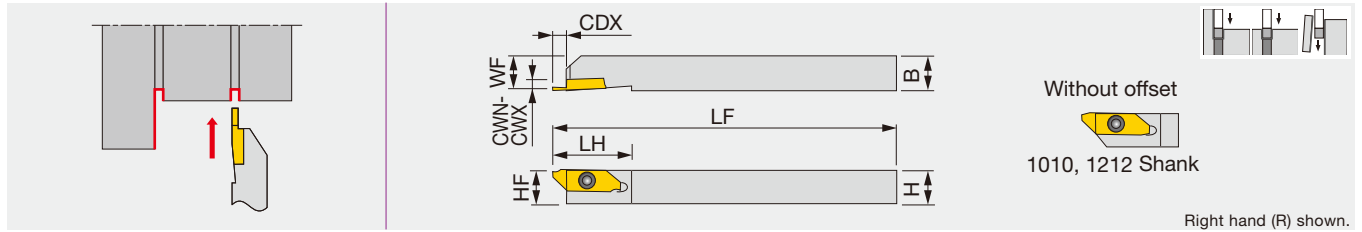

Designation	CWN	CWX	CDX	H	B	LF	LH	HF	WF	Insert	Torque*
JSXGR/L1010K8-C	0.7	2	4.5 - 6	10	10	125	29	10	9.9	JXG...	1.3
JSXGR/L1212K8-C	0.7	2	4.5 - 6	12	12	125	29	12	11.9	JXG...	1.3
JSXGR/L1616K8	0.7	2	4.5 - 6	16	16	125	29	16	15.9	JXG...	1.3
JSXGR/L2020K8	0.7	2	4.5 - 6	20	20	125	29	20	19.9	JXG...	1.3
JSXGR/L2525K8	0.7	2	4.5 - 6	25	25	125	29	25	24.9	JXG...	1.3

Can be wrenched also from the back with a double-head screw.
This toolholder can be used for JXF front-turning insert, JXR reverse-turning insert, and JXG parting and grooving insert.
*Torque: Recommended clamping torque (N-m)

SPARE PARTS

Designation	Clamping screw	Wrench 1	Wrench 2 (Optional)
JSXGR/L...	CSTB-4SD	T-8F	(T-8L)

INSERT

JXG (with hand, sharp edge)

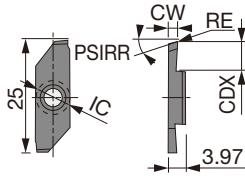

Right hand (R) shown.

	P	M	K	N	S	H
Steel	★					☆
Stainless	★					
Cast iron						☆
Non-ferrous				★		
Superalloys					★	
Hard materials						

★ : First choice
☆ : Second choice

Designation	HAND	CW±0.025	RE	Coated		Uncoated		CDX	IC	PSIRR
				J740	TH10					
JXGR8070FA	R	0.7	0	●	●			4.5	8	15°
JXGL8070FA	L	0.7	0	●	●			4.5	8	15°
JXGR8070FA-005	R	0.7	0.05	●				4.5	8	15°
JXGR8100FA	R	1	0	●	●			6	8	15°
JXGL8100FA	L	1	0	●	●			6	8	15°
JXGR8100FA-005	R	1	0.05	●				6	8	15°
JXGR8100FA45	R	1	0	●	●			4.5	8	15°
JXGR8100FA45-005	R	1	0.05	●				4.5	8	15°
JXGR8150FA	R	1.5	0	●	●			6	8	15°
JXGL8150FA	L	1.5	0	●	●			6	8	15°
JXGR8150FA-005	R	1.5	0.05	●				6	8	15°
JXGR8150FA50	R	1.5	0	●	●			5	8	15°
JXGR8150FA50-005	R	1.5	0.05	●				5	8	15°
JXGR8180FA	R	1.8	0	●	●			6	8	15°
JXGR8180FA-005	R	1.8	0.05	●				6	8	15°
JXGR8200FA	R	2	0	●	●			6	8	15°
JXGL8200FA	L	2	0	●	●			6	8	15°
JXGR8200FA-005	R	2	0.05	●				6	8	15°
JXGR8200FN	R	2	0	●	●			6	8	0°
JXGL8200FN	L	2	0	●	●			6	8	0°
JXGR8200FN-005	R	2	0.05	●				6	8	0°

● : Line up

Reference pages: Standard cutting conditions → F114

JCCWSR/L

External grooving and parting toolholder, for Swiss lathes

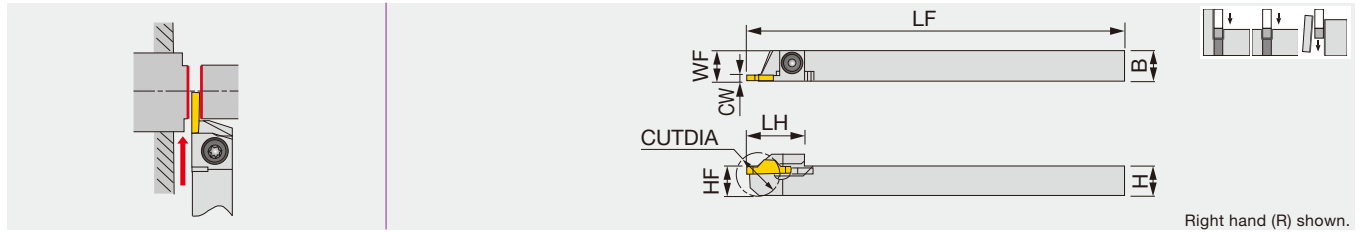

Designation	CW	CUTDIA	H	B	LF	LH	HF	WF	Insert	Torque*
JCCWSR/L1010K2	2	20	10	10	125	19	10	10	JCC*200...	3.5
JCCWSR/L1212K2	2	20	12	12	125	19	12	12	JCC*200...	3.5
JCCWSR/L1616K2	2	20	16	16	125	19	16	16	JCC*200...	3.5
JCCWSR/L2020K2	2	20	20	20	125	19	20	20	JCC*200...	3.5
JCCWSR/L2525K2	2	20	25	25	125	19	25	25	JCC*200...	3.5

*Torque: Recommended clamping torque (N·m)

SPARE PARTS

Designation	Clamping screw	Wrench 1	Wrench 2 (Optional)
JCCWSR/L...	CSTB-4S	T-15F	(T-15L)

INSERT

JCC (Sharp edge)

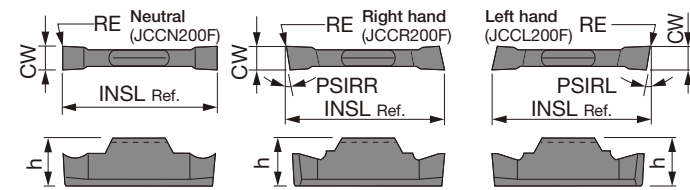

	P	M	K	N	S	H
Steel	★					☆
Stainless	★					
Cast iron						☆
Non-ferrous				★		
Superalloys					★	
Hard materials						

★ : First choice
☆ : Second choice

Designation	HAND	CW±0.025	RE	Coated		Uncoated				INSL	h	PSIRL	PSIRR
				J740	TH10								
JCCN200F	N	2	0	●	●					15	4.8	0°	0°
JCCN200F-005	N	2	0.05	●						15	4.8	0°	0°
JCCR200F	R	2	0	●	●					15	4.8	0°	15°
JCCL200F	L	2	0	●	●					15	4.8	15°	0°
JCCR200F-005	R	2	0.05	●						15	4.8	0°	15°
JCCL200F-005	L	2	0.05	●						15	4.8	15°	0°

● : Line up

Reference pages: Standard cutting conditions → **F114**



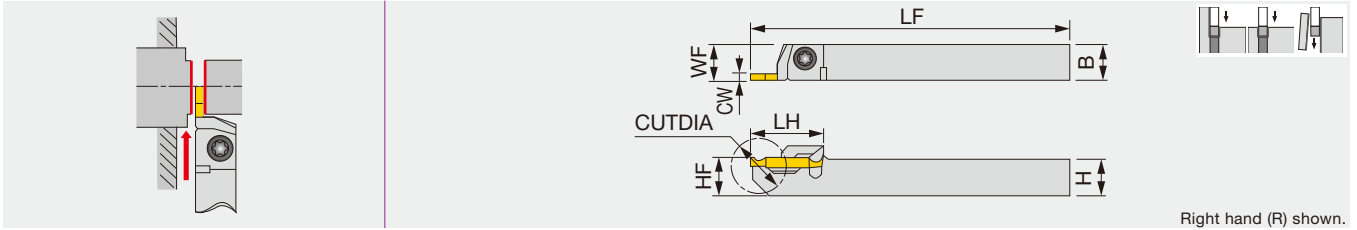

Designation	CW	CUTDIA	H	B	LF	LH	HF	WF	Insert	Torque*
JCGWSR/L1010K2	2	20	10	10	125	20	10	10	JCGN200F...	3.5
JCGWSR/L1212K2	2	20	12	12	125	20	12	12	JCGN200F...	3.5
JCGWSR/L1616K2	2	20	16	16	125	20	16	16	JCGN200F...	3.5

*Torque: Recommended clamping torque (N·m)

SPARE PARTS

Designation	Clamping screw	Wrench 1	Wrench 2 (Optional)
JCGWSR/L...	CSTB-4S	T-15F	(T-15L)

INSERT

JCGN (Sharp edge)

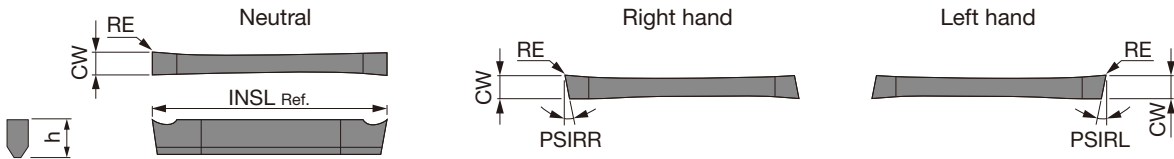

P	Steel	★		☆					
M	Stainless	★							
K	Cast iron			☆					
N	Non-ferrous			★					
S	Superalloys			★					
H	Hard materials								

★ : First choice
☆ : Second choice

Designation	HAND	CW±0.025	RE	Coated		Uncoated		INSL	h	PSIRL	PSIRR
				J740	TH10						
JCGN200F	N	2	0.05	●	●			20	3	0°	0°
JCGN200FR	R	2	0.05	●	●			20	3	0°	8°
JCGN200FL	L	2	0.05	●	●			20	3	8°	0°

● : Line up

JSTGR/L

External grooving toolholder, for Swiss lathes

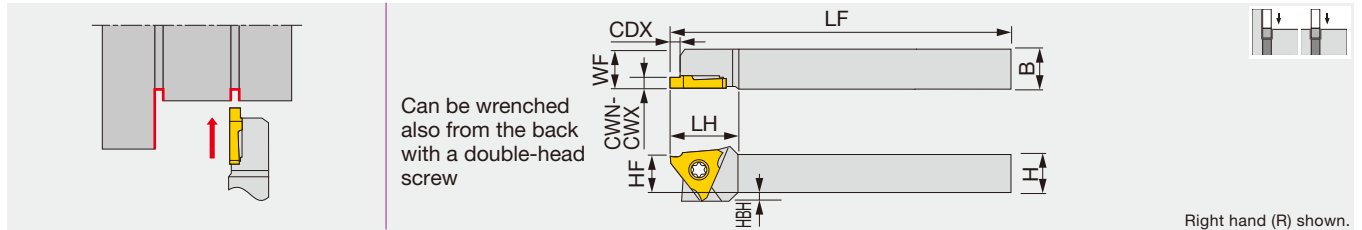

Designation	CWN	CWX	CDX	H	B	LF	LH	HF	WF	HBH	Insert	Torque*
JSTGR/L1010X3	0.33	3	0.7 - 2.6	10	10	120	18.5	10	10	2	JTGR/L3...	1.2
JSTGR/L1212F3	0.33	3	0.7 - 2.6	12	12	85	18.5	12	12	-	JTGR/L3...	1.2
JSTGR/L1212X3	0.33	3	0.7 - 2.6	12	12	120	18.5	12	12	-	JTGR/L3...	1.2
JSTGR/L1616X3	0.33	3	0.7 - 2.6	16	16	120	18.5	16	16	-	JTGR/L3...	1.2
JSTGL1616K3	0.33	3	0.7 - 2.6	16	16	125	18.5	16	16	-	JTGR/L3...	1.2

*Torque: Recommended clamping torque (N·m)

JS-TGL3

External grooving toolholder, for Swiss lathes

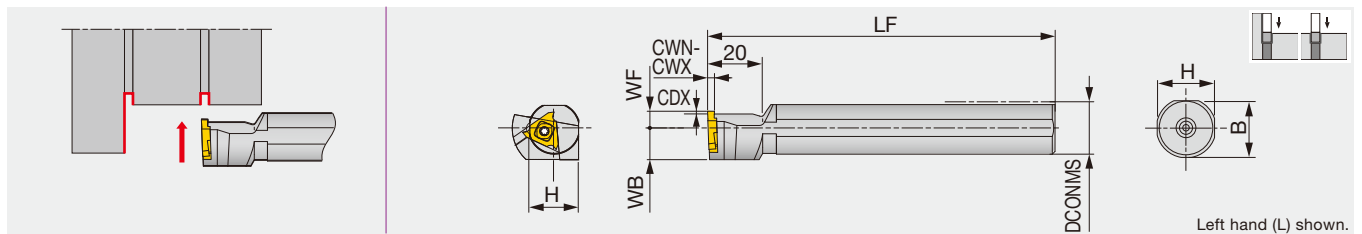

Designation	CWN	CWX	CDX	DCONMS	H	B	LF	WF	WB	Insert	Torque*
JS19K-TGL3	0.33	3	0.7 - 2.6	19.05	18	18	125	6	11.5	JTGR3...	3
JS20K-TGL3	0.33	3	0.7 - 2.6	20	19	19	125	6	11.5	JTGR3...	3
JS22K-TGL3	0.33	3	0.7 - 2.6	22	21	21	125	6	11.5	JTGR3...	3
JS25K-TGL3	0.33	3	0.7 - 2.6	25.4	24	24	125	10	12.7	JTGR3...	3

Note: Use left-hand toolholders (L) with right-hand inserts (R).

*Torque: Recommended clamping torque (N·m)

SPARE PARTS

Designation	Clamping screw	Wrench 1	Wrench 2 (Optional)
JSTGR/L...	CSTB-4SD	T-8F	(T-8L)
JS**-TGL3	CSTB-4S	T-15F	-

Reference pages: Inserts → **F112, F113**, Standard cutting conditions → **F114**



INSERTS

JTG (Sharp edge)

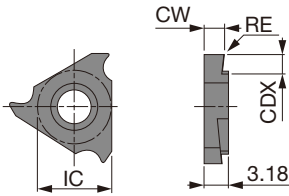

Right hand (R) shown.

P	Steel	★	★		★		☆			
M	Stainless	★	★							
K	Cast iron						☆		★	
N	Non-ferrous								★	
S	Superalloys								★	
H	Hard materials									

★ : First choice
☆ : Second choice



Designation	HAND	CW ^{+0.05}	RE	Coated		Cermet	Uncoated		CDX	IC
				SH725	J740	NS9530	TH10			
JTGR3033F	R	0.33	0.03	●	●			●	0.7	9.53
JTGL3033F	L	0.33	0.03		●			●	0.7	9.53
JTGR3033F-005	R	0.33	0.05	●					0.7	9.53
JTGR3043F	R	0.43	0.03	●	●				1.1	9.53
JTGR3050F	R	0.5	0.03	●	●	●		●	1.1	9.53
JTGL3050F	L	0.5	0.03	●	●			●	1.1	9.53
JTGR3050F-005	R	0.5	0.05	●					1.1	9.53
JTGL3050F-005	L	0.5	0.05	●					1.1	9.53
JTGR3065F	R	0.65	0.03	●	●				1.9	9.53
JTGR3065F-010	R	0.65	0.1	●					1.9	9.53
JTGR3075F	R	0.75	0.03	●	●	●		●	1.9	9.53
JTGL3075F	L	0.75	0.03	●	●	●		●	1.9	9.53
JTGR3075F-010	R	0.75	0.1	●					1.9	9.53
JTGL3075F-010	L	0.75	0.1	●					1.9	9.53
JTGR3080F	R	0.8	0.03	●	●				1.9	9.53
JTGR3080F-010	R	0.8	0.1	●					1.9	9.53
JTGR3085F	R	0.85	0.03	●	●				1.9	9.53
JTGR3095F	R	0.95	0.03	●	●	●		●	1.9	9.53
JTGL3095F	L	0.95	0.03	●	●			●	1.9	9.53
JTGR3095F-010	R	0.95	0.1	●					1.9	9.53
JTGL3095F-010	L	0.95	0.1	●					1.9	9.53
JTGR3100F	R	1	0.05	●	●	●		●	2.1	9.53
JTGL3100F	L	1	0.05	●	●			●	2.1	9.53
JTGR3100F-010	R	1	0.1	●					2.1	9.53
JTGL3100F-010	L	1	0.1	●					2.1	9.53
JTGR3110F	R	1.1	0.05	●	●				2.1	9.53
JTGR3120F	R	1.2	0.05	●	●				2.1	9.53
JTGR3120F-010	R	1.2	0.1	●					2.1	9.53
JTGR3125F	R	1.25	0.05	●	●	●		●	2.1	9.53
JTGL3125F	L	1.25	0.05	●	●			●	2.1	9.53
JTGR3125F-010	R	1.25	0.1	●					2.1	9.53
JTGL3125F-010	L	1.25	0.1	●					2.1	9.53
JTGR3130F	R	1.3	0.05	●	●				2.1	9.53
JTGR3140F	R	1.4	0.05	●	●				2.1	9.53
JTGR3140F-010	R	1.4	0.1	●					2.1	9.53
JTGR3145F	R	1.45	0.05	●	●	●		●	2.1	9.53
JTGL3145F	L	1.45	0.05	●	●			●	2.1	9.53
JTGR3145F-010	R	1.45	0.1	●					2.1	9.53
JTGR3150F	R	1.5	0.05	●	●	●		●	2.1	9.53
JTGL3150F	L	1.5	0.05	●	●			●	2.1	9.53
JTGR3150F-010	R	1.5	0.1	●					2.1	9.53
JTGL3150F-010	L	1.5	0.1	●					2.1	9.53

● : Line up

Reference pages: Toolholders → **F111**, Standard cutting conditions → **F114**

JTG (Sharp edge)

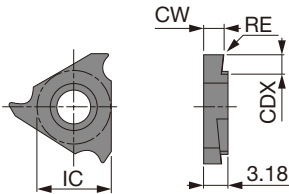

Right hand (R) shown.

P Steel	★	★		★		☆			
M Stainless	★	★							
K Cast iron						☆		★	
N Non-ferrous								★	
S Superalloys								★	
H Hard materials									

★ : First choice
☆ : Second choice

Designation	HAND	CW ^{+0.05}	RE	Coated		Cermet		Uncoated		CDX	IC
				SH725	J740	NS9530		TH10			
JTGR3175F	R	1.75	0.05	●	●	●		●		2.1	9.53
JTGL3175F	L	1.75	0.05		●	●		●		2.1	9.53
JTGR3175F-010	R	1.75	0.1	●						2.1	9.53
JTGR3180F	R	1.8	0.05	●	●					2.1	9.53
JTGR3200F	R	2	0.05	●	●	●		●		2.6	9.53
JTGL3200F	L	2	0.05	●	●			●		2.6	9.53
JTGR3200F-010	R	2	0.1	●						2.6	9.53
JTGL3200F-010	L	2	0.1	●						2.6	9.53
JTGR3225F	R	2.25	0.05	●	●					2.6	9.53
JTGR3250F	R	2.5	0.05	●	●	●		●		2.6	9.53
JTGL3250F	L	2.5	0.05	●	●			●		2.6	9.53
JTGR3250F-010	R	2.5	0.1	●						2.6	9.53
JTGL3250F-010	L	2.5	0.1	●						2.6	9.53
JTGR3275F	R	2.75	0.05		●					2.6	9.53
JTGR3300F	R	3	0.05	●	●					2.6	9.53
JTGR3300F-010	R	3	0.1	●						2.6	9.53

● : Line up

JTG (honed edge)

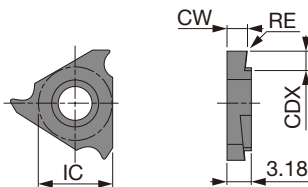

Right hand (R) shown.

P Steel	★								
M Stainless									
K Cast iron				☆					
N Non-ferrous									
S Superalloys									
H Hard materials									

★ : First choice
☆ : Second choice

Designation	HAND	CW ^{+0.05}	RE	Coated		Cermet		Uncoated		CDX	IC
				J9530							
JTGR3100	R	1	0.05	●						2.1	9.53
JTGR3125	R	1.25	0.05	●						2.1	9.53
JTGR3150	R	1.5	0.05	●						2.1	9.53
JTGR3200	R	2	0.05	●						2.6	9.53

● : Line up

STANDARD CUTTING CONDITIONS (J-Series grooving tool)

ISO	Workpiece material	Grade	Cutting Speed Vc (m/min)	Feed f (mm/rev)
P	General steels, Free-cutting steels, etc.	J740	10 - 100	0.01 - 0.1
		SH725	50 - 150	0.01 - 0.1
		NS9530	50 - 150	0.01 - 0.1
		J9530	50 - 150	0.01 - 0.1
M	Stainless steels, etc.	J740	10 - 100	0.01 - 0.1
		SH725	50 - 150	0.01 - 0.1
N	Aluminium alloys, copper alloys, etc.	TH10	10 - 200	0.01 - 0.1
S	Difficult-to-cut materials, titanium alloys, etc.	TH10	10 - 30	0.01 - 0.1



MY-T SERIES

CGWSR/L-FLR/L#GP

External grooving and turning toolholder

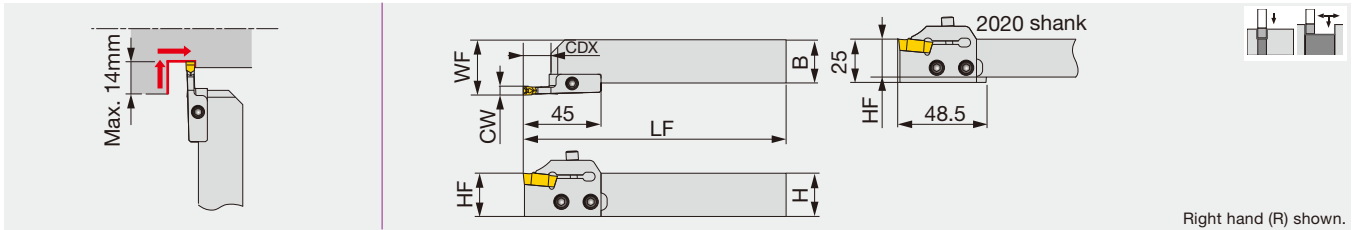

Designation	CW	CDX	H	B	LF	HF	WF	Insert	Shank	Adapter	Torque*
CGWSR/L2020-FLR/L3GP	3	10	20	20	152	20	27	FLEX30R/L	CGWSR/L2020	FLR/L3GP	5
CGWSR/L2525-FLR/L3GP	3	10	25	25	152	25	32	FLEX30R/L	CGWSR/L2525	FLR/L3GP	5
CGWSR/L2020-FLR/L4GP	4	12	20	20	152	20	27	FLEX40R/L	CGWSR/L2020	FLR/L4GP	5
CGWSR/L2525-FLR/L4GP	4	12	25	25	152	25	32	FLEX40R/L	CGWSR/L2525	FLR/L4GP	5
CGWSR/L2020-FLR/L5GP	5	14	20	20	152	20	27	FLEX50R/L	CGWSR/L2020	FLR/L5GP	5
CGWSR/L2525-FLR/L5GP	5	14	25	25	152	25	32	FLEX50R/L	CGWSR/L2525	FLR/L5GP	5

Toolholders are in stock with the designations of: a set of shank and adapter; a shank; a adapter. Combining the designations of a adapter and a shank will make the designation of a set. Please check the stock and place an order with the designation of a set or a shank+a adapter.
Use right-hand toolholders (CGWSR...) with right-hand adapter (FLR...); and left-hand toolholders (CGWSL...) with left-hand adapter (FLR...).

*Torque: Recommended clamping torque (N·m)

SPARE PARTS

Designation	Clamping screw	Adapter screw	Wrench
CGWSR/L***-FLR/L#GP	CHHM5-18	CSHB-6	P-4

Caution

Toolholders with FLEX insert have mechanism in which the end cutting edge angle is formed by accepting a cutting force. In external grooving, there is a possibility that if the cutting conditions (feed and depth of cut) are set too high, the programmed diameter will not be achieved. To prevent this problem, it is necessary to perform a compensation in the program by an amount that is equal to the amount A'-A that is shown in the drawing on the right. The values of compensation corresponding to the feeds are also shown in the graph.

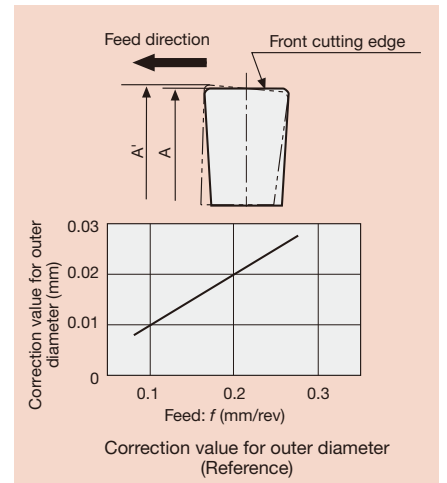

INSERT

FLEX(R/L)

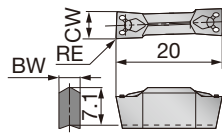

Right hand (R) shown.

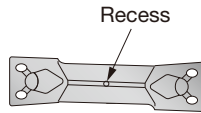

To distinguish the insert hands, the V-shape surface (top surface) of a left-hand insert has a recess. (not of a right-hand insert)

P	Steel	★				★				★		
M	Stainless	★								★		
K	Cast iron	☆				☆						
N	Non-ferrous											
S	Superalloys											
H	Hard materials											

★ : First choice
☆ : Second choice

Designation	HAND	CW±0.05	RE	Coated		Cermet		Uncoated		BW
				T9225		NS9530		UX30		
FLEX30R	R	3	0.4			●				2.2
FLEX30L	L	3	0.4			●				2.2
FLEX40R	R	4	0.4			●				3.1
FLEX40L	L	4	0.4			●				3.1
FLEX50R	R	5	0.4	●		●		●		4
FLEX50L	L	5	0.4	●		●		●		4

● : Line up

- External
- Internal
- Face
- Parting
- Others

STANDARD CUTTING CONDITIONS

ISO	Workpiece material	Grade	Cutting Speed V _c (m/min)	Feed: f (mm/rev)	
				Grooving	Turning
P	Carbon steel	T9225	80 - 300	0.05 - 0.25	0.1 - 0.3
		NS9530	80 - 200	0.05 - 0.25	0.1 - 0.3
		UX30	60 - 150	0.05 - 0.25	0.1 - 0.3

Reference pages: Toolholders → **F115**

CTWR/L

External grooving and parting toolholder, for 2 corner inserts

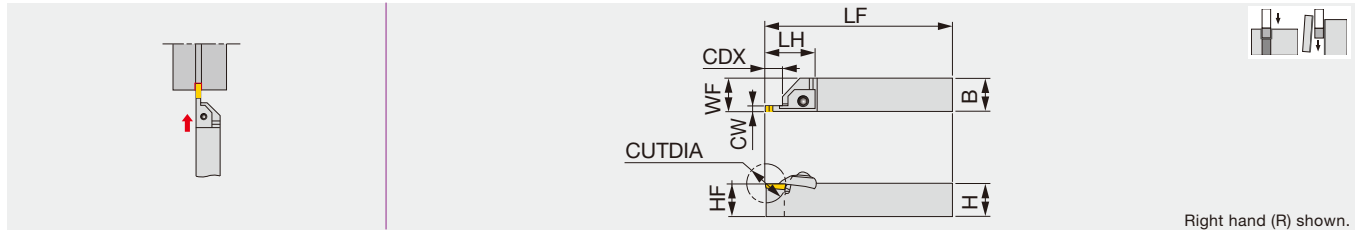

Designation	CW	CUTDIA	CDX	H	B	LF	LH	HF	WF	Insert	Torque*
CTWR/L2020-3	3	32	14	20	20	150	41	20	20.25	CTD3	5
CTWR/L2525-3	3	32	14	25	25	150	41	25	25.25	CTD3	5
CTWR/L2020-4	4	32	14	20	20	150	41	20	20.25	CTD4	5
CTWR/L2525-4	4	32	14	25	25	150	41	25	25.25	CTD4	5
CTWR/L2525-5	5	42	20	25	25	150	46	25	25.25	CTD5	5

*Torque: Recommended clamping torque (N·m)

SPARE PARTS

Designation	Clamp	Pin	Clamping screw	Washer	Wrench
CTWR2020-3	CTC-3R	BP-360	CTS-M6	CDW6	P-4
CTWL2020-3	CTC-3L	BP-360	CTS-M6	CDW6	P-4
CTWR2525-3	CTC-3R	BP-360	CTS-M6	CDW6	P-4
CTWL2525-3	CTC-3L	BP-360	CTS-M6	CDW6	P-4
CTWR2020-4	CTC-4R	BP-360	CTS-M6	CDW6	P-4
CTWL2020-4	CTC-4L	BP-360	CTS-M6	CDW6	P-4
CTWR2525-4	CTC-4R	BP-360	CTS-M6	CDW6	P-4
CTWL2525-4	CTC-4L	BP-360	CTS-M6	CDW6	P-4
CTWR2525-5	CTC-5R	BP-360	CTS-M6	CDW6	P-4
CTWL2525-5	CTC-5L	BP-360	CTS-M6	CDW6	P-4

INSERT

CTD

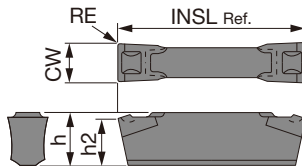

P Steel	★							
M Stainless	★							
K Cast iron	☆							
N Non-ferrous								
S Superalloys								
H Hard materials								

★ : First choice
☆ : Second choice

Designation	CW±0.1	RE	Coated						INSL	h	h2
			AH725								
CTD3	3	0.2	●						20	4.3	4
CTD4	4	0.2	●						20	5.3	5
CTD5	5	0.2	●						25	6.3	6

● : Line up

STANDARD CUTTING CONDITIONS

ISO	Workpiece material	Grade	Cutting Speed Vc (m/min)	Feed: f (mm/rev)	
				Grooving	Parting off
P	Carbon steel	AH725	80 - 180	0.08 - 0.3	0.08 - 0.15
M	Stainless steel	AH725	50 - 120	0.08 - 0.25	0.08 - 0.1



MY-T SERIES

CGWSR/L-CGD

External grooving and parting toolholder

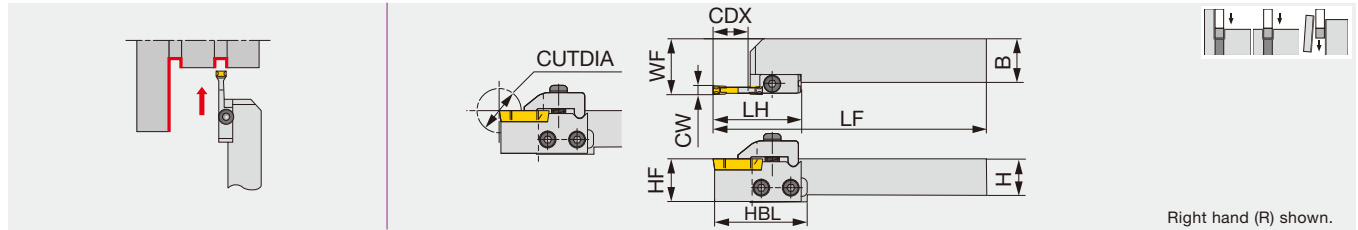

Designation	CW	CUTDIA	CDX	H	B	LF	LH	HBL	HF	WF	Insert	Shank	Adapter	Torque*
CGWSR/L2020-CGDR/L2	2	35	16	20	20	152	45	48.5	20	26.45	CGD200	CGWSR/L2020	CGDR/L2	5
CGWSR/L2525-CGDR/L2	2	35	16	25	25	152	45	-	25	31.45	CGD200	CGWSR/L2525	CGDR/L2	5
CGWSR/L2020-CGDR/L3	3	46	21.6	20	20	157.6	50.6	54.1	20	26.45	CGD300	CGWSR/L2020	CGDR/L3	5
CGWSR/L2525-CGDR/L3	3	46	21.6	25	25	157.6	50.6	-	25	31.45	CGD300	CGWSR/L2525	CGDR/L3	5
CGWSR/L2020-CGDR/L4	4	46	21.6	20	20	157.6	50.6	54.1	20	26.65	CGD400	CGWSR/L2020	CGDR/L4	5
CGWSR/L2525-CGDR/L4	4	46	21.6	25	25	157.6	50.6	-	25	31.65	CGD400	CGWSR/L2525	CGDR/L4	5
CGWSR/L2020-CGDR/L5	5	46	21.6	20	20	157.6	50.6	54.1	20	26.95	CGD500	CGWSR/L2020	CGDR/L5	5
CGWSR/L2525-CGDR/L5	5	46	21.6	25	25	157.6	50.6	-	25	31.95	CGD500	CGWSR/L2525	CGDR/L5	5
CGWSR/L2020-CGDR/L6	6	46	21.6	20	20	157.6	50.6	54.1	20	27.1	CGD600	CGWSR/L2020	CGDR/L6	5
CGWSR/L2525-CGDR/L6	6	46	21.6	25	25	157.6	50.6	-	25	32.1	CGD600	CGWSR/L2525	CGDR/L6	5
CGWSR2525-8	7 / 8	50	21.6	25	25	150	-	-	25	26.35	CGD700, CGD800	-	-	8.5
CGWSR3232-8	7 / 8	50	21.6	32	32	170	-	-	32	33.35	CGD700, CGD800	-	-	8.5

When using a right or left hand adapter set, the right hand adapter set is used with right hand shank and the left hand adapter set is used with left hand shank.
*Torque: Recommended clamping torque (N·m)

SPARE PARTS

Designation	Adapter	Clamp	Clamping screw	Adapter screw	Spring pin	Spring	Wrench
CGWSR****-CGDR2	TCR2	CCR2	RT-1	CSHB-6	-	BP-9	P-4
CGWSL****-CGDL2	TCL2	CCL2	RT-1	CSHB-6	-	BP-9	P-4
CGWSR****-CGDR3	TCR3	CCR3	RT-1	CSHB-6	-	BP-9	P-4
CGWSL****-CGDL3	TCL3	CCL3	RT-1	CSHB-6	-	BP-9	P-4
CGWSR****-CGDR4	TCR4	CCR4	RT-1	CSHB-6	-	BP-9	P-4
CGWSL****-CGDL4	TCL4	CCL4	RT-1	CSHB-6	-	BP-9	P-4
CGWSR****-CGDR5	TCR5	CCR5	RT-1	CSHB-6	-	BP-9	P-4
CGWSL****-CGDL5	TCL5	CCL5	RT-1	CSHB-6	-	BP-9	P-4
CGWSR****-CGDR6	TCR6	CCR6	RT-1	CSHB-6	-	BP-9	P-4
CGWSL****-CGDL6	TCL6	CCL6	RT-1	CSHB-6	-	BP-9	P-4
CGWSR****-8	-	CCR/L-8	CHHM6-20	-	5X14AW	BP-9	P-5

INSERT

CGD

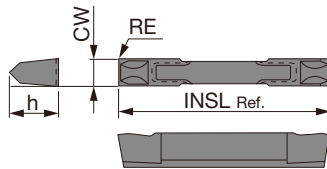

P	Steel	☆		★		★				
M	Stainless	★				★				
K	Cast iron			☆						
N	Non-ferrous									
S	Superalloys									
H	Hard materials									

★ : First choice
☆ : Second choice

Designation	CW±0.025	RE	Coated			Cermet			Uncoated			INSL	h
			GH330			NS9530			UX30				
CGD200	2	0.2	●			●			●			20	3.25
CGD300	3	0.2	●			●			●			28.6	6.3
CGD400	4	0.2	●			●			●			28.6	6.3
CGD500	5	0.2	●			●			●			28.6	6.3
CGD600	6	0.2	●			●			●			28.6	8.5
CGD700	7	0.2	●						●			28.6	8.5
CGD800	8	0.2	●						●			28.6	8.5

● : Line up

STANDARD CUTTING CONDITIONS

ISO	Workpiece material	Grade	Cutting Speed V _c (m/min)	Feed: f (mm/rev)	
				Grooving	Parting off
P	Carbon steel	GH330	70 - 180	0.08 - 0.3	0.08 - 0.15
		NS9530	80 - 200	0.08 - 0.3	0.08 - 0.15
		UX30	60 - 150	0.08 - 0.3	0.08 - 0.15

Grade
Insert
Ext. Toolholder
Int. Toolholder
Threading
Grooving
Miniature tool
Milling cutter
Endmill
Drilling tool
Tooling System
User's Guide
Index

A
B
C
D
E
F
G
H
I
J
K
L
M

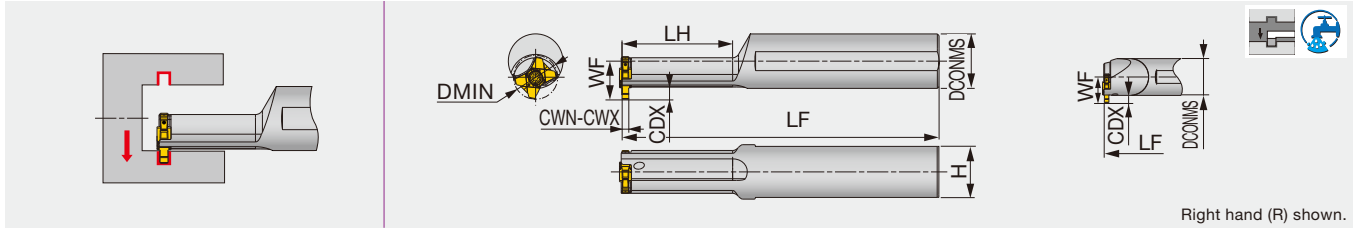

Right hand (R) shown.

Designation	Material	CWN	CWX	DMIN	DCONMS	LH	LF	WF	H	Insert	Torque*
A12H-STCIR/L10-D105	Steel	1.5	3	10.5	12	25	100	8.3	11	TCIG10...	1
A12H-STCIR/L10-D120	Steel	1.5	3	12	12	31	100	8.3	11	TCIG10...	1
E12K-STCIR/L10-D150	Carbide	1.5	3	15	12	-	125	8.3	11	TCIG10...	1
A16J-STCIR/L12-D130	Steel	1.5	3	13	16	33	110	11.3	15	TCIG12...	1.3
A16J-STCIR/L12-D160	Steel	1.5	3	16	16	41	110	11.3	15	TCIG12...	1.3
E16M-STCIR/L12-D200	Carbide	1.5	3	20	16	-	150	11.3	15	TCIG12...	1.3

Torque*: Recommended clamping torque (N-m)

SPARE PARTS



Designation	Clamping screw
A/E-STCIR10-...	CSTB-2.2L053DR
A/E-STCIL10-...	CSTB-2.2L053DL
A/E-STCIR12-...	CSTB-2.5L054DR
A/E-STCIL12-...	CSTB-2.5L054DL



Internal grooving head

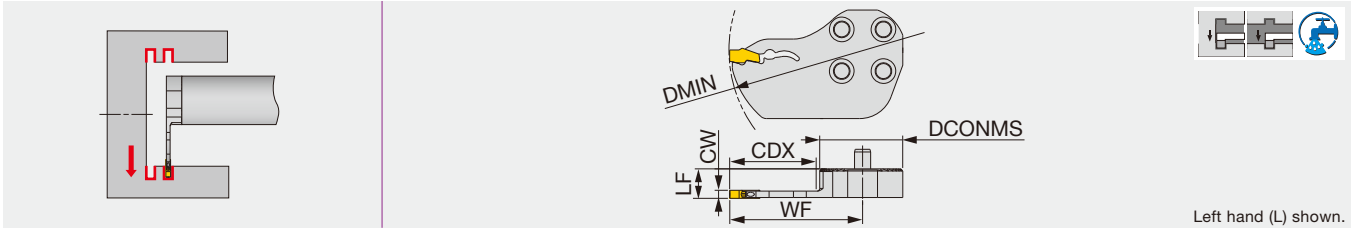

Designation	CW	CDX	DMIN	DCONMS*	Seat size	LF	WF	Shank
S25-QSIR/L2T26D550-H	2	26	55	25	2	8.5	40.1	D25
S25-QSIR/L3T26D550-H	3	26	55	25	3	9	40.1	D25
S32-QSIR/L3T32D700-H	3	32	70	32	3	11	49.6	D32
S32-QSIR/L4T32D700-H	4	32	70	32	4	11.5	49.6	D32

DCONMS*: Mounting part diameter on the shank

SPARE PARTS

Designation	Wrench
S**-QSIR/L...	QL-39

Straight Shank

Anti-vibration bars with through coolant for interchangeable turning heads, for S-QSIR/L modular heads

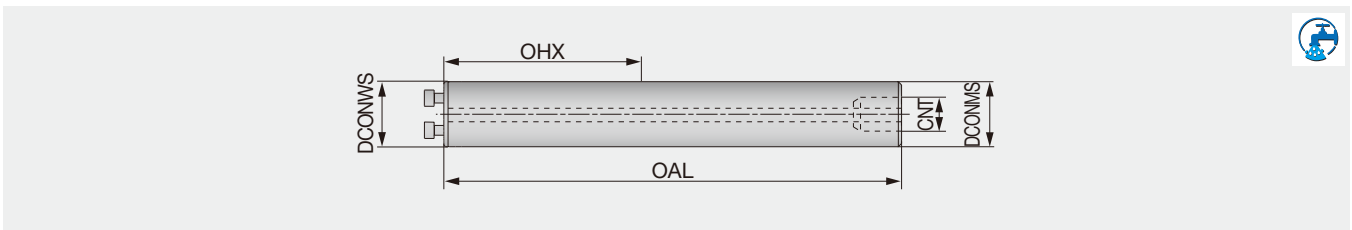

Designation	Material	DCONWS*	DCONMS	OAL	OHX	CNT
D25-L255-7D-C	Steel	25	25	257.5	155	G1/4
D25-L330-10D-C	Steel	25	25	332.5	230	G1/4
D32-L320-7D-C	Steel	32	32	323	192	G3/8
D32-L416-10D-C	Steel	32	32	419	288	G3/8

DCONWS*: Mounting part diameter on the head

SPARE PARTS

Designation	Clamping screw	Wrench
D25-L...	SRM4X12DIN912	HW3.0
D32-L...	SRM5X12DIN912	HW4.0

C#-SH-CHP / C#-SH-E-CHP

Tool adapter with PSC connection (made of steel or carbide), for S-QSIR/L modular heads

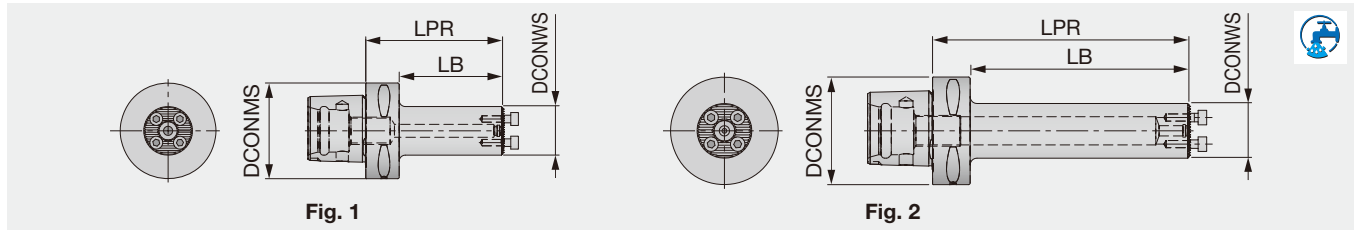

Designation	Material	DCONWS*	DCONMS	LPR	LB	Fig
C4-SH-D25-2.5D-CHP	Steel	25	40	55	35	1
C4-SH-D32-2.5D-CHP	Steel	32	40	75	55	1
C6-SH-D25-5D-E-CHP	Carbide	25	63	115	93	2
C6-SH-D32-5D-E-CHP	Carbide	32	63	150	128	2

DCONWS*: Mounting part diameter on the head

D#4D-SH

Steel shank for internal turning, with through coolant, for S-QSIR/L modular heads

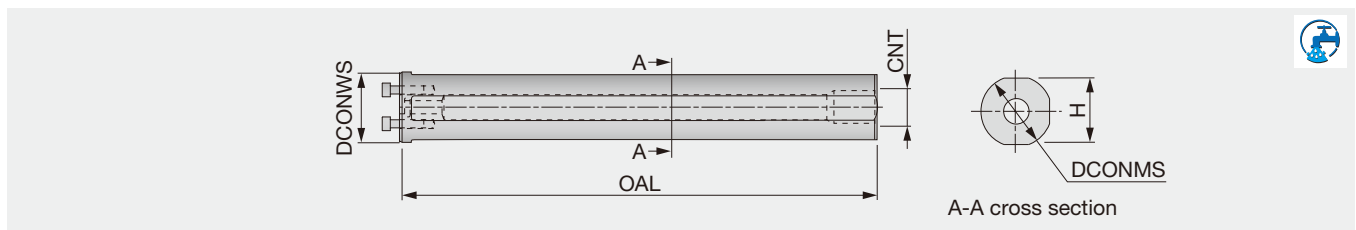

Designation	Material	DCONWS*	DCONMS	OAL	CNT	H
D25-L200-4D-SH	Steel	25	25	200	UNF-2B 1/2"-20	23
D32-L218-4D-SH	Steel	32	32	218	UNF-2B 1/2"-20	29

DCONWS*: Mounting part diameter on the head

C6-9D-C

Vibration-dampening toolholder with PSC connection, 9xD, for S-QSIR/L modular heads

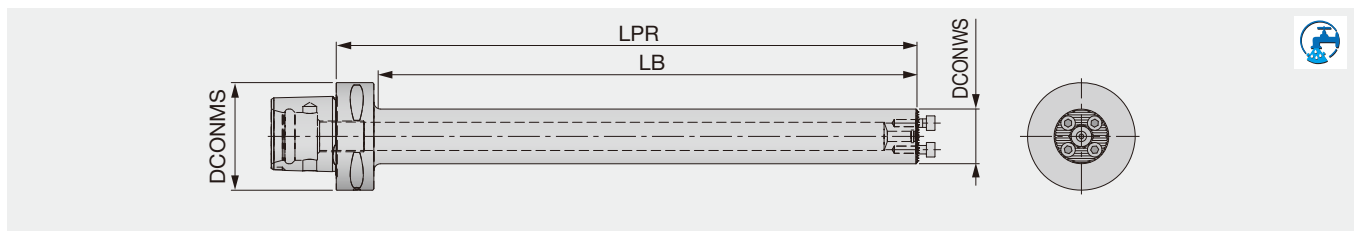

Designation	Material	DCONWS*	DCONMS	LPR	LB	WT (kg)
C6-D25-L230-9D-C	Steel	25	63	230.5	200.1	1.65
C6-D32-L288-9D-C	Steel	32	63	288.5	259.5	2.73

DCONWS*: Mounting part diameter on the head

SPARE PARTS

Designation	Clamping screw	Wrench
C4/C6**D25... D25-L...	SRM4X12DIN912	HW3.0
C4/C6**D32... D32-L...	SRM5X12DIN912	HW4.0

Reference pages: Inserts → **F124, F125**, Standard cutting conditions → **F125**

CHIPBREAKER GUIDE

QGM



First choice for grooving and parting

Smooth chip evacuation
Well-designed edge with high strength
CW = 2 - 4 mm

■ Standard feed

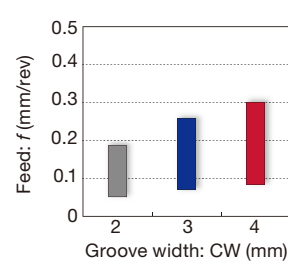

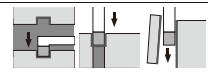

QGS



Lower cutting force and superior sharpness

Uniquely designed edge and chipbreaker
CW = 2 - 4 mm

■ Standard feed

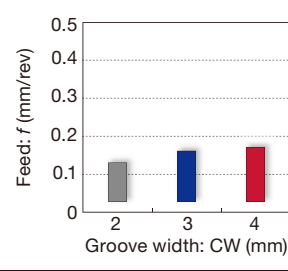

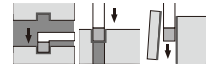

- External
- Internal
- Face
- Parting
- Others

INSERTS

QGM

External/internal deep grooving and parting

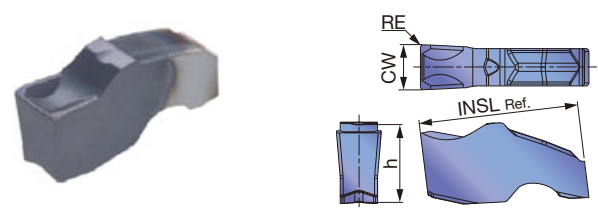

P	Steel	★									
M	Stainless	★									
K	Cast iron	★									
N	Non-ferrous										
S	Superalloys	★									
H	Hard materials										

★ : First choice

Designation	Seat size	CW±0.05	RE	Coated								INSL	h	
				AH7025										
QGM2-020	2	2	0.2	●									11	5.3
QGM3-020	3	3	0.2	●									11	5.3
QGM4-030	4	4	0.3	●									13	7.3

● : Line up

QGS

External/internal deep grooving and parting

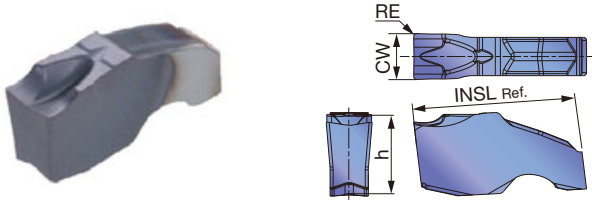

P	Steel	★									
M	Stainless	★									
K	Cast iron	★									
N	Non-ferrous										
S	Superalloys	★									
H	Hard materials										★ : First choice

Designation	Seat size	CW±0.05	RE	Coated								INSL	h
				AH7025									
QGS2-020	2	2	0.2	●								11	5.3
QGS3-020	3	3	0.2	●								11	5.3
QGS4-030	4	4	0.3	●								13	7.3

● : Line up

STANDARD CUTTING CONDITIONS

ISO	Workpiece material	Hardness	Grade	Cutting speed Vc (m/min)
P	Steels C45, 34CrMo4, etc.	< 300 HB	AH7025	50 - 180
M	Stainless steel X10CrNiS18-9, etc.	< 200 HB	AH7025	50 - 120
K	Gray cast iron GG25, 250, etc.	-	AH7025	50 - 180
	Ductile cast irons GGG45, 450-10S, etc.	-	AH7025	50 - 120
S	Superalloys Inconel718, etc.	< HRC 40	AH7025	20 - 40
	Titanium alloys Ti-6Al-4V, etc.	< HRC 40	AH7025	20 - 60

Please see page **F124** for feed: *f* (mm/rev).

Reference pages: Toolholders → **F122, F123**

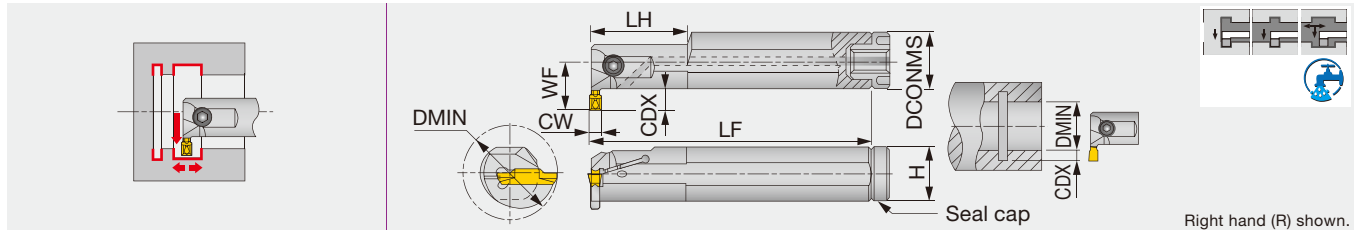

Designation	CW	DMIN	Seat size	CDX	DCONMS	H	LF ⁽¹⁾	LH	WF	Insert	Torque*
CTIR/L16-2T08-D250	2	25	2	8	16	14	125	-	16.5	DGIM..., DGIS..., DTX...	5
CTIR/L20-2T06-D250	2	25	2	6	20	18	160	40	15.8	DGIM..., DGIS..., DTX...	5
CTIR/L20-3T06-D250	3	25	3	6	20	18	160	40	15.8	DTI..., DTX...	5
CTIR/L25-3T05-D250	3	25	3	5.1	25	23	200	40	17.5	DTI..., DTX...	5
CTIR/L25-3T08-D320	3	32	3	8	25	23	200	40	21.5	DTI..., DTX...	5
CTIR/L32-3T10-D400	3	40	3	10	32	30	250	60	27	DTI..., DTX...	5
CTIR/L20-4T06-D250	4	25	4	6	20	18	160	40	15.8	DTI..., DTX...	5
CTIR/L25-4T08-D320	4	32	4	8	25	23	200	40	21.5	DTI..., DTX...	5
CTIR/L32-4T04-D310	4	31	4	4	32	30	250	60	20.8	DTI..., DTX...	5
CTIR/L32-4T10-D400	4	40	4	10	32	30	250	60	27	DTI..., DTX...	5
CTIR/L25-5T05-D310	5	31	5	5	25	23	200	60	17.3	DTI..., DTX...	8.5
CTIR/L32-5T10-D400	5	40	5	10	32	30	250	60	27	DTI..., DTX...	8.5
CTIR/L32-6T04-D310	6	31	6	4	32	30	250	60	20.8	DTI..., DTX...	8.5
CTIR/L32-6T10-D400	6	40	6	10	32	30	250	60	27	DTI..., DTX...	8.5
CTIR/L32-8T05-D370	8	37	8	5	32	30	250	60	21.3	DTI..., DTX...	8.5
CTIR/L40-8T05-D420	8	42	8	5.8	40	38	300	65	25.8	DTI..., DTX...	8.5

(1) LF is calculated with the groove width CW in the above table.
Torque*: Recommended clamping torque (N·m)

SPARE PARTS









Designation	Clamping screw	Wrench	Seal cap	Thread type for connection
CTIR/L16-2T08-D250	CM5X0.8X10-A	P-4	CA-16	M6
CTIR/L20-2T06-D250	CM5X0.8X12-A	P-4	CA-20	M6
CTIR/L20-3T06-D250	CM5X0.8X12-A	P-4	CA-20	M6
CTIR/L25-3T05-D250	CM5X0.8X16-A	P-4	CA-25	R1/8"
CTIR/L25-3T08-D320	CM5X0.8X16-A	P-4	CA-25	R1/8"
CTIR/L32-3T10-D400	CM5X0.8X16-A	P-4	CA-32	R1/8"
CTIR/L20-4T06-D250	CM5X0.8X12-A	P-4	CA-20	M6
CTIR/L25-4T08-D320	CM5X0.8X16-A	P-4	CA-25	R1/8"
CTIR/L32-4T04-D310	CM5X0.8X16-A	P-4	CA-32	R1/8"
CTIR/L32-4T10-D400	CM5X0.8X16-A	P-4	CA-32	R1/8"
CTIR/L25-5T05-D310	CM6X1X16-A	P-5	CA-25	R1/8"
CTIR/L32-5T10-D400	CM6X1X20-A	P-5	CA-32	R1/8"
CTIR/L32-6T04-D310	CM6X1X20-A	P-5	CA-32	R1/8"
CTIR/L32-6T10-D400	CM6X1X20-A	P-5	CA-32	R1/8"
CTIR/L32-8T05-D370	CM6X1X20-A	P-5	CA-32	R1/8"
CTIR/L40-8T05-D420	CM6X1X25-A	P-5	CA-40	R1/8"

When using the inserts that are not in the above

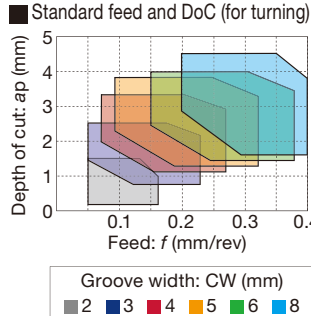
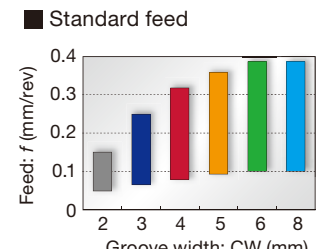
INSERT	Groove width		Min. diameter
	CW	DMIN	
DGM / DGS / SGN / DGL / DTM	2	50	
DGM / DGS / SGN / DGL / DTM	3	50	
DGM / DGS / SGN / DTM / DGL	4	50	
DGM / DGS / DTM / DGL	5	60	
DGM / DGS / DTM / DGL	6	60	
DGM / DGS / DTM	8	70	
DTE / DGG	3	40	
DTE / DGG	4	40	
DTE / DGG	5	50	
DTE / DGG	6	50	
DTE / DGG	8	62	
DTR	2	45	
DTR	3	38	
DTR	4	38	
DTR	5	43	
DTR	6	46	
DTR	8	56	

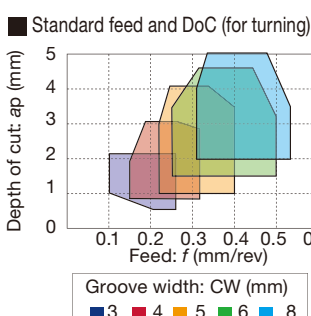
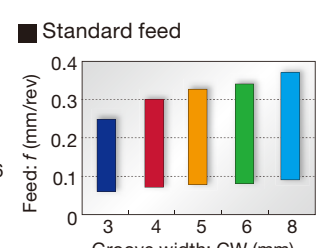
Reference pages: Inserts → **F127 - F144**, Standard cutting conditions → **F145**

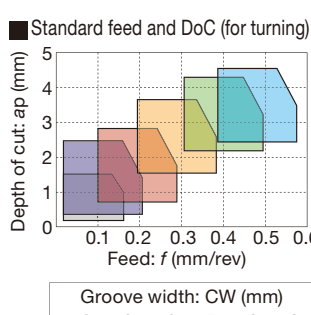
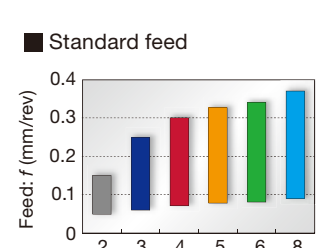

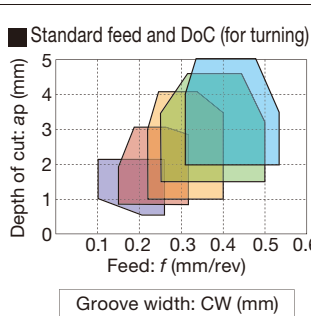
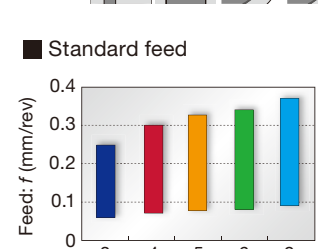



Internal grooving and turning

<p>DTX type (2 corners)</p> <p>First choice</p>  <p>F132</p>	<p>Multi-functional type</p> <p>Well balanced sharpness and strength Multi-functional insert CW = 2 - 8 mm</p>	<p>Standard feed and DoC (for turning)</p>  <p>Standard feed</p> 
<p>DTI type (2 corners)</p>  <p>F133, F134</p>	<p>For general purpose I.D. grooving</p> <p>Unique chipbreaker makes chips shorter Molded and ground inserts available CW = 3 - 8 mm</p>	<p>Standard feed and DoC (for turning)</p>  <p>Standard feed</p> 
<p>DTM type (2 corners)</p>  <p>F134</p>	<p>General purpose</p> <p>1st choice for grooving and turning Suitable for light to medium cutting Excellent chip control in machining steel, alloy steel, stainless steel, and heat-resistant alloy CW = 2 - 8 mm</p>	<p>Standard feed and DoC (for turning)</p>  <p>Standard feed</p> 
<p>DTE type (2 corners)</p>  <p>F139</p>	<p>General purpose</p> <p>Unique chipbreaker makes chips shorter Molded and ground insert available CW = 2.65 - 8 mm</p>	<p>Standard feed and DoC (for turning)</p>  <p>Standard feed</p> 

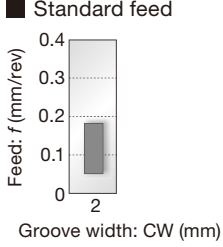
Please see page F*** for the product details.

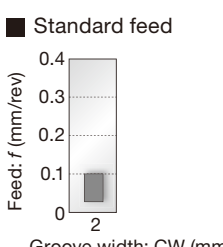

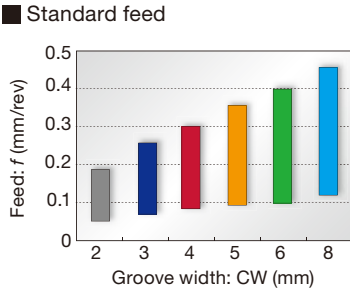
Small diameter internal grooving

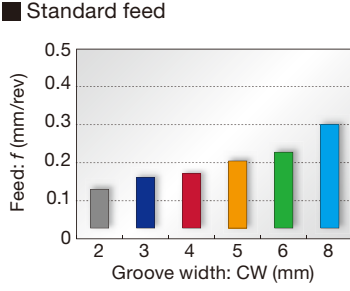
<p>DGIM type (2 corners)</p>  <p>F132</p>	<p>2 mm insert width only (For general purpose)</p> <p>Unique chipbreaker for excellent chip control Excellent fracture resistance due to optimum land on the cutting edge For general applications on steels & stainless steels CW = 2 mm</p>	<p>Standard feed</p>  <p>Feed: f (mm/rev)</p> <p>Groove width: CW (mm)</p>
<p>DGIS type (2 corners)</p>  <p>F133</p>	<p>2 mm insert width only (Lower cutting force)</p> <p>Lower cutting force Excellent fracture resistance due to optimum land on the cutting edge Applicable for low carbon steels & stainless steels CW = 2 mm</p>	<p>Standard feed</p>  <p>Feed: f (mm/rev)</p> <p>Groove width: CW (mm)</p>
<p>DGM type (2 corners) SGM type (1 corner)</p>  <p>F135, F136</p>	<p>1st choice for grooving and parting</p> <p>Smooth chip evacuation Well-designed edge with high strength Handed insert available CW = 2 - 8 mm</p>	<p>Standard feed</p>  <p>Feed: f (mm/rev)</p> <p>Groove width: CW (mm)</p>
<p>DGS type (2 corners) SGS type (1 corner)</p>  <p>F137, F138</p>	<p>Lower cutting force and superior sharpness</p> <p>Unique-designed edge and chipbreaker Handed insert available CW = 2 - 8 mm</p>	<p>Standard feed</p>  <p>Feed: f (mm/rev)</p> <p>Groove width: CW (mm)</p>

Please see page F*** for the product details.

Small diameter internal grooving

DGL type (2 corners)

1st choice for mild steel

Chipbreaker with excellent chip control at low feed
Suitable for mild steel that often gives difficulties in chip control
CW = 2 - 6 mm

F139

Standard feed

Groove width: CW (mm)	Feed: f (mm/rev)
2	0.15
3	0.18
4	0.20
5	0.22
6	0.30

DGG type (2 corners)

For non-ferrous materials and titanium

Chipbreaker with low cutting force
Sharp cutting edge that prevents vibration and delivers fine surface finish
CW = 2 - 6 mm

F140

Standard feed

Groove width: CW (mm)	Feed: f (mm/rev)
2	0.15
3	0.16
4	0.17
5	0.17
6	0.18

Profiling and undercutting

DTR type (2 corners)
STR type (1 corner)

Molded DTR, STR
Ground DTR

F141, F142

Full radius type

Excellent chip control
Molded and ground inserts available
CW = 2 - 8 mm

Standard feed and DoC (for turning)

Feed: f (mm/rev)	ap (mm) for CW=2	ap (mm) for CW=3	ap (mm) for CW=4	ap (mm) for CW=5	ap (mm) for CW=6	ap (mm) for CW=8
0.1	0.5	0.8	1.2	1.8	2.5	3.5
0.2	0.8	1.2	1.8	2.5	3.5	4.5
0.3	1.2	1.8	2.5	3.5	4.5	5.5
0.4	1.8	2.5	3.5	4.5	5.5	6.5
0.5	2.5	3.5	4.5	5.5	6.5	7.5
0.6	3.5	4.5	5.5	6.5	7.5	8.5
0.7	4.5	5.5	6.5	7.5	8.5	9.5

DTIU type (2 corners)

F142

Full radius type

Excellent chip control for undercutting
CW = 3 - 6 mm

Standard feed and DoC

Groove width: CW (mm)	Feed: f (mm/rev)
3	0.25
4	0.30
5	0.32
6	0.35

Please see page F*** for the product details.

Aluminium wheel machining

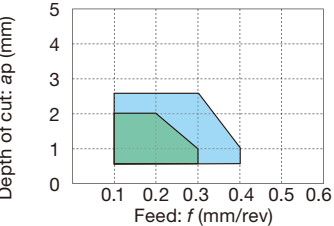
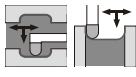
<p>DTA type (2 corners)</p>  <p>F143</p>	<p>Full radius type</p> <p>Excellent chip control For aluminium wheel profiling Ground insert CW = 6 - 8 mm</p>	<p>■ Standard feed and DoC (for turning)</p>  <p>Depth of cut: a_p (mm)</p> <p>Feed: f (mm/rev)</p> <p>Groove width: CW (mm)</p> <p>■ 6 ■ 8</p> 
---	--	---

For high feed external/internal/face turning of hardened steel parts

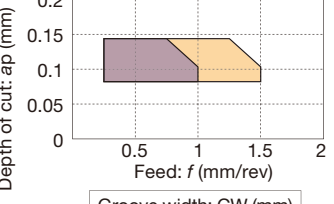
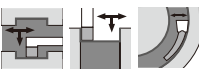
<p>STH type (1 corner)</p>  <p>F143</p>	<p>External and face turning of hardened steel parts</p> <p>High efficiency machining using light D.O.C. and increased feeds CW = 3, 5 mm</p>	<p>■ Standard feed and DoC (for turning)</p>  <p>Depth of cut: a_p (mm)</p> <p>Feed: f (mm/rev)</p> <p>Groove width: CW (mm)</p> <p>■ 3 ■ 5</p> 
--	--	---

External/internal grooving of hardened steel

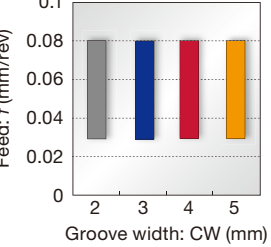
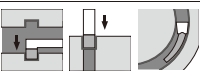
<p>SGN-CBN type (1 corner)</p>  <p>F144</p>	<p>For hardened steel cutting</p> <p>Optimum cutting edge shape for grooving of hardened steels High tolerance width for finishing CW = 2 - 5 mm (CW = ± 0.025 mm)</p>	<p>■ Standard feed</p>  <p>Feed: f (mm/rev)</p> <p>Groove width: CW (mm)</p> 
--	---	---

Please see page F*** for the product details.

GRADE SELECTION

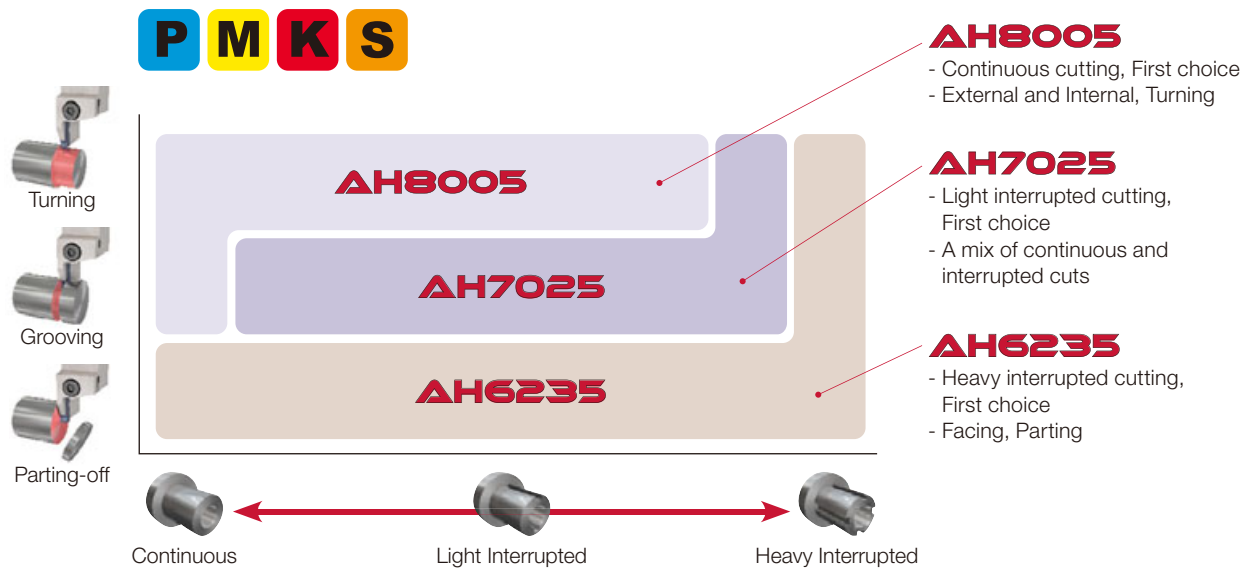

GRADES

AH8005 P M K S

- First choice for external, internal, and side-turning, continuous cuts

AH7025 P M K S

- First choice for light interrupted cuts or a mix of continuous and interrupted cuts
- New PVD coating with high Al content provides excellent adhesion strength
- Improved wear and chipping resistance

AH6235 P M K

- First choice for heavy interrupted cuts, as well as parting and facing applications

AH725 P M S

- General purpose PVD grade for high fracture resistance

T515 K

- First recommended grade for cast iron
- Excellent wear resistance in high speed machining

T9225 P

- Suitable for steel machining at high speeds
- New CVD coating and substrate deliver an outstanding balance of wear and chipping resistance

NS9530 P

- Advanced cermet for finish cutting of steel
- Innovative grade with incredible fracture and high wear resistance

GH130 P M K

- Recommended for interrupted machining
- TiCNO PVD coating layer with high wear resistance
- High hardness wear resistance

AH905 S

- Remarkable for machining of heat resistant alloys
- Exclusive coating layer improves adhesion strength and wear resistance

KS05F N S

- Recommended for non-ferrous materials and titanium

TH10 N

- Recommended for non-ferrous materials

BXA10 H

- Coated CBN grade designed for turning hardened steel parts

BX360 H

- Developed for grooving applications of hardened steel parts



INSERTS

DTX

External/internal/face grooving and turning

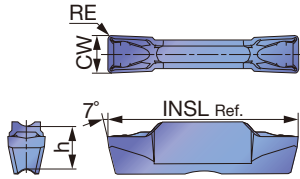

P	Steel	★	★	☆	★	☆	★	★	★											
M	Stainless	★	☆	★	★	★	★	★	★											
K	Cast iron	★		★	★	☆	★	★	★	☆										☆
N	Non-ferrous																			☆
S	Superalloys	★	☆	★																★
H	Hard materials																			

★ : First choice
☆ : Second choice

Designation	Seat size	CW±0.05	RE	Coated					Cermet		Uncoated		INSL	h	
				T9225	AH7025	AH725	AH8005	GH130	AH6235	NS9530		KS05F			
DTX2-020	2	2	0.2	●	●	●	●	●	●			●		20	5
DTX3-030	3	3	0.3	●	●	●	●	●	●			●		20	5
DTX4-040	4	4	0.4	●	●	●	●	●	●			●		20	5
DTX5-040	5	5	0.4	●	●	●	●	●	●			●		25	5.5
DTX6-080	6	6	0.8	●	●	●	●	●	●			●		25	5.5
DTX8-080	8	8	0.8	●	●	●	●	●	●			●		30	6.7

● : Line up

DGIM

Small diameter internal grooving

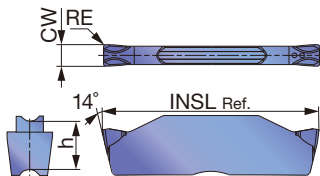

P	Steel	★	★	☆	☆					★										
M	Stainless		★	☆	★															
K	Cast iron		★		☆					☆										
N	Non-ferrous																			
S	Superalloys		★	☆																
H	Hard materials																			

★ : First choice
☆ : Second choice

Designation	Seat size	CW±0.05	RE	Coated				Cermet		INSL	h
				T9225	AH7025	AH725	GH130	NS9530			
DGIM2-020	2	2	0.2	●	●	●	●	●		20	5

● : Line up

Reference pages: Toolholders → **F126**, Standard cutting conditions → **F145**

DGIS

Small diameter internal grooving

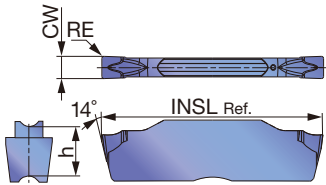

P	Steel	★	★	☆	☆					★							
M	Stainless		★	☆	★												
K	Cast iron		★		☆					☆							
N	Non-ferrous																
S	Superalloys		★	☆													
H	Hard materials																

★ : First choice
☆ : Second choice

Designation	Seat size	CW±0.05	RE	Coated				Cermet				INSL	h	
				T9225	AH7025	AH725	GH130	NS9530						
DGIS2-020	2	2	0.2	●	●	●	●						20	5

●: Line up

DTI

Internal grooving and turning (for high precision)

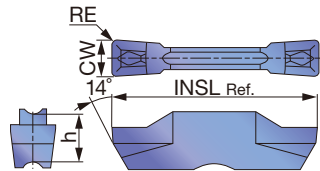

P	Steel	★	★	☆	☆					★							
M	Stainless		★	☆	★												
K	Cast iron		★		☆					☆							
N	Non-ferrous																
S	Superalloys		★	☆													
H	Hard materials																

★ : First choice
☆ : Second choice

Designation	Seat size	CW±0.02	RE	Coated				Cermet				INSL	h	
				T9225	AH7025	AH725	GH130	NS9530						
DTI300-040	3	3	0.4	●	●	●	●						20	5
DTI400-040	4	4	0.4	●	●	●	●						20	5
DTI400-080	4	4	0.8	●	●	●	●						20	5
DTI500-040	5	5	0.4	●	●	●	●						25	5.5
DTI500-080	5	5	0.8	●	●	●	●						25	5.5
DTI600-080	6	6	0.8	●	●	●	●						25	5.5
DTI600-120	6	6	1.2	●	●	●	●						25	5.5
DTI800-080	8	8	0.8	●	●	●	●						30	6.7
DTI800-120	8	8	1.2	●	●	●	●						30	6.7

●: Line up

Reference pages: Toolholders → **F126**, Standard cutting conditions → **F145**



DTI

Internal grooving and turning

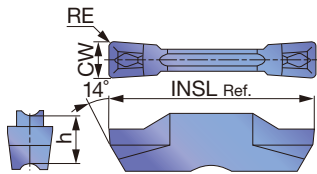

P	Steel	★	★	☆	☆				★			
M	Stainless		★	☆	★							
K	Cast iron		★		☆				☆			
N	Non-ferrous											
S	Superalloys		★	☆								
H	Hard materials											

★ : First choice
☆ : Second choice

Designation	Seat size	CW±0.05	RE	Coated				Cermet	INSL	h
				T9225	AH7025	AH725	GH130	NS9530		
DTI3-040	3	3	0.4	●	●	●	●	●	20	5
DTI4-040	4	4	0.4	●	●	●	●	●	20	5

● : Line up

DTM

External/internal/face grooving and turning

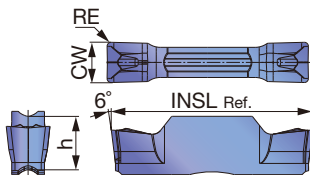

P	Steel	★	★	★					
M	Stainless	★	★	★					
K	Cast iron	★	★	★					
N	Non-ferrous								
S	Superalloys	★	★						
H	Hard materials								

★ : First choice
☆ : Second choice

Designation	Seat size	CW±0.05	RE	Coated			INSL	h
				AH7025	AH8005	AH6235		
DTM2-020	2	2	0.2	●	●	●	20	5
DTM3-030	3	3	0.3	●	●	●	20	5
DTM4-040	4	4	0.4	●	●	●	20	5
DTM4-080	4	4	0.8	●	●	●	20	5
DTM5-080	5	5	0.8	●	●	●	25	5.5
DTM6-080	6	6	0.8	●	●	●	25	5.5
DTM8-080	8	8	0.8	●	●	●	30	6.7

● : Line up

Reference pages: Toolholders → **F126**, Standard cutting conditions → **F145**

DGM

External/internal grooving and parting

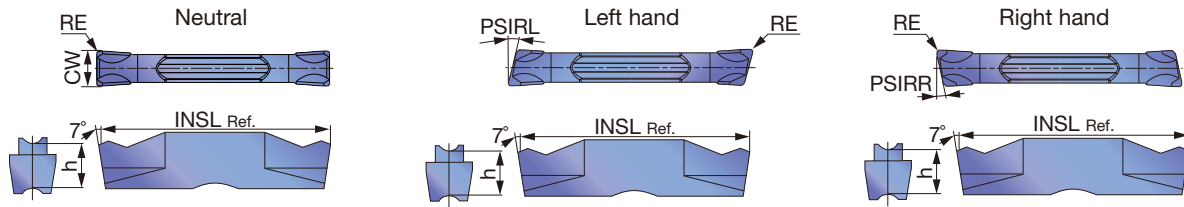

P Steel	★	★	☆	★	☆	★	★	★						
M Stainless		★	☆	★	★	★	★	★						
K Cast iron		★		★	☆	☆	★	☆			☆			
N Non-ferrous											☆			
S Superalloys		★	☆	★	★						★			
H Hard materials														

★ : First choice
☆ : Second choice

Designation	Seat size	HAND	CW±0.05	RE	Coated						Cermet	Uncoated	INSL	h	PSIRL	PSIRR	
					T9225	AH7025	AH725	AH8005	AH905	GH130	AH6235	NS9530					KS05F
DGM2-020	2	N	2	0.2	●	●	●	●	●	●	●	●	●	20	5	0°	0°
DGM2-020-6R	2	R	2	0.2		●	●			●				20	5	0°	6°
DGM2-020-6L	2	L	2	0.2		●	●			●				20	5	6°	0°
DGM2-020-8R	2	R	2	0.2		●	●			●				20	5	0°	8°
DGM2-020-8L	2	L	2	0.2		●	●			●				20	5	8	0°
DGM2-020-15R	2	R	2	0.2		●	●			●				20	5	0°	15°
DGM2-020-15L	2	L	2	0.2		●	●			●				20	5	15°	0°
DGM2-002-15R	2	R	2	0.02			●			●				19.35	5	0°	15°
DGM2-002-15L	2	L	2	0.02			●			●				19.35	5	15°	0°
DGM2.39-020	2	N	2.39	0.2		●		●		●				20	5	0°	0°
DGM3-020	3	N	3	0.2	●	●	●	●	●	●	●	●	●	20	5	0°	0°
DGM3-020-6R	3	R	3	0.2		●	●			●				20	5	0°	6°
DGM3-020-6L	3	L	3	0.2		●	●			●				20	5	6°	0°
DGM3-002-6R	3	R	3	0.02			●			●				19.45	5	0°	6°
DGM3-002-6L	3	L	3	0.02			●			●				19.45	5	6°	0°
DGM3-020-15R	3	R	3	0.2		●	●			●				20	5	0°	15°
DGM3-020-15L	3	L	3	0.2		●	●			●				20	5	15°	0°
DGM3.18-020	3	N	3.18	0.2		●		●		●				20	5	0°	0°
DGM4-030	4	N	4	0.3	●	●	●	●	●	●	●	●	●	20	5	0°	0°
DGM4-030-4R	4	R	4	0.3		●	●			●				20	5	0°	4°
DGM4-030-4L	4	L	4	0.3		●	●			●				20	5	4°	0°
DGM4-030-15R	4	R	4	0.3		●	●			●				20	5	0°	15°
DGM4-030-15L	4	L	4	0.3		●	●			●				20	5	15°	0°
DGM4.76-040	5	N	4.76	0.4		●		●		●				25	5.5	0°	0°
DGM5-030	5	N	5	0.3	●	●	●	●	●	●	●	●	●	25	5.5	0°	0°
DGM5-030-4R	5	R	5	0.3		●	●			●				25	5.5	0°	4°
DGM6-030	6	N	6	0.3	●	●	●	●	●	●	●	●	●	25	5.5	0°	0°
DGM6.35-040	6	N	6.35	0.4		●		●		●				25	5.5	0°	0°
DGM8-040	8	N	8	0.4	●	●	●	●		●		●		30	6.7	0°	0°

●: Line up

SGM

External/internal deep grooving and parting

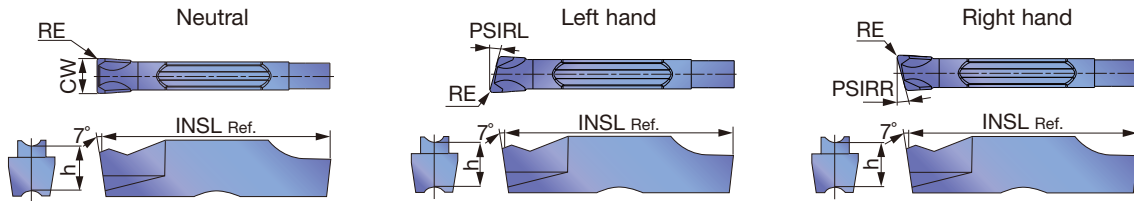

P Steel	★	☆	★	☆	★								
M Stainless	★	☆	★	★	★								
K Cast iron	★		★	☆	★		☆						
N Non-ferrous							☆						
S Superalloys	★	☆	★				★						
H Hard materials													

★ : First choice
☆ : Second choice

Designation	Seat size	HAND	CW±0.05	RE	Coated					Uncoated				INSL	h	PSIRL	PSIRR
					AH7025	AH725	AH8005	GH130	AH6235	KS05F							
SGM2-020	2	N	2	0.2	●	●	●	●	●	●				20	5	0°	0°
SGM2-020-6R	2	R	2	0.2	●	●		●						20	5	0°	6°
SGM2-020-6L	2	L	2	0.2	●	●		●						20	5	6°	0°
SGM3-020	3	N	3	0.2	●	●	●	●	●	●				20	5	0°	0°
SGM3-020-6R	3	R	3	0.2	●	●		●						20	5	0°	6°
SGM3-020-6L	3	L	3	0.2	●	●		●						20	5	6°	0°
SGM3-020-15R	3	R	3	0.2	●	●		●						20	5	0°	15°
SGM3-020-15L	3	L	3	0.2	●	●		●						20	5	15°	0°
SGM4-030	4	N	4	0.3	●	●	●	●	●	●				20	5	0°	0°
SGM4-030-4R	4	R	4	0.3	●	●		●						20	5	0°	4°
SGM4-030-4L	4	L	4	0.3	●	●		●						20	5	4°	0°
SGM5-030	5	N	5	0.3	●	●	●	●	●	●				25	5.5	0°	0°
SGM6-030	6	N	6	0.3	●	●	●	●	●	●				25	5.5	0°	0°
SGM8-040	8	N	8	0.4	●		●		●	●				30	6.7	0°	0°

●: Line up

Reference pages: Toolholders → **F126**, Standard cutting conditions → **F145**

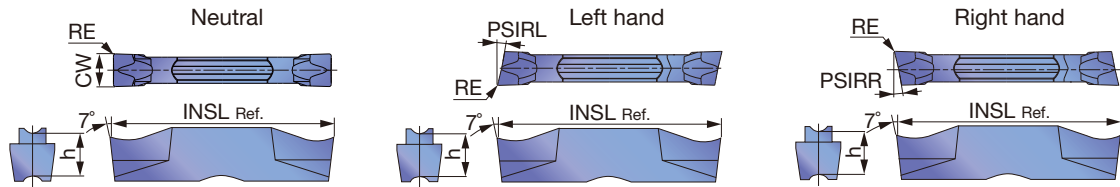

P	Steel	★	★	☆	★	☆	★	★						
M	Stainless		★	☆	★	★	★							
K	Cast iron		★		★	☆	★		☆			☆		
N	Non-ferrous											☆		
S	Superalloys		★	☆	★							★		
H	Hard materials													

★ : First choice
☆ : Second choice

Designation	Seat size	HAND	CW±0.05	RE	Coated						Cermet		Uncoated		INSL	h	PSIRL	PSIRR
					T9225	AH7025	AH725	AH8005	GH130	AH6235	NS9530		KS05F					
DGS2-005	2	N	2	0.05			●								20	5	0°	0°
DGS2-010	2	N	2	0.1			●								20	5	0°	0°
DGS2-020	2	N	2	0.2	●	●	●	●	●	●	●		●		20	5	0°	0°
DGS2-020-6R	2	R	2	0.2		●	●		●						20	5	0°	6°
DGS2-020-6L	2	L	2	0.2		●	●		●						20	5	6°	0°
DGS2-002-6R	2	R	2	0.02			●		●						19.5	5	0°	6°
DGS2-002-6L	2	L	2	0.02			●		●						19.5	5	6°	0°
DGS2-020-15R	2	R	2	0.2		●	●		●						20	5	0°	15°
DGS2-020-15L	2	L	2	0.2		●	●		●						20	5	15°	0°
DGS2-002-15R	2	R	2	0.02			●		●						19.5	5	0°	15°
DGS2-002-15L	2	L	2	0.02			●		●						19.5	5	15°	0°
DGS2.39-020	2	N	2.39	0.2		●		●		●					20	5	0°	0°
DGS3-020	3	N	3	0.2	●	●	●	●	●	●	●		●		20	5	0°	0°
DGS3-020-6R	3	R	3	0.2		●	●		●						20	5	0°	6°
DGS3-020-6L	3	L	3	0.2		●	●		●						20	5	6°	0°
DGS3-002-6R	3	R	3	0.02			●		●						19.45	5	0°	6°
DGS3-002-6L	3	L	3	0.02			●		●						19.45	5	6°	0°
DGS3-020-15R	3	R	3	0.2		●	●		●						20	5	0°	15°
DGS3-020-15L	3	L	3	0.2		●	●		●						20	5	15°	0°
DGS3-002-15R	3	R	3	0.02			●		●						19.45	5	0°	15°
DGS3-002-15L	3	L	3	0.02			●		●						19.45	5	15°	0°
DGS3.18-020	3	N	3.18	0.2		●		●		●					20	5	0°	0°
DGS4-030	4	N	4	0.3	●	●	●	●	●	●	●		●		20	5	0°	0°
DGS4-030-4R	4	R	4	0.3		●	●		●						20	5	0°	4°
DGS4-030-4L	4	L	4	0.3		●	●		●						20	5	4°	0°
DGS4.76-040	5	N	4.76	0.4		●		●		●					25	5.5	0°	0°
DGS5-030	5	N	5	0.3	●	●	●	●	●	●	●		●		25	5.5	0°	0°
DGS6-030	6	N	6	0.3	●	●	●	●	●	●	●		●		25	5.5	0°	0°
DGS6.35-040	6	N	6.35	0.4		●		●		●					25	5.5	0°	0°
DGS8-040	8	N	8	0.4		●		●		●					30	6.7	0°	0°

●: Line up

Caution

The tool will interfere with the workpiece when grooving larger diameters than øDmax.

Designation	øDmax (mm)	Designation	øDmax (mm)
DGM2-002-15R/L	28	DGS2-002-15R/L	28
DGM3-002-15R/L	29	DGS3-002-15R/L	29
DGM4-030-15R/L	30	SGS3-020-15R/L	103
SGM3-020-15R/L	103	SGS3-002-15R/L	34

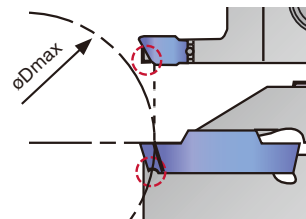

External/internal deep grooving and parting

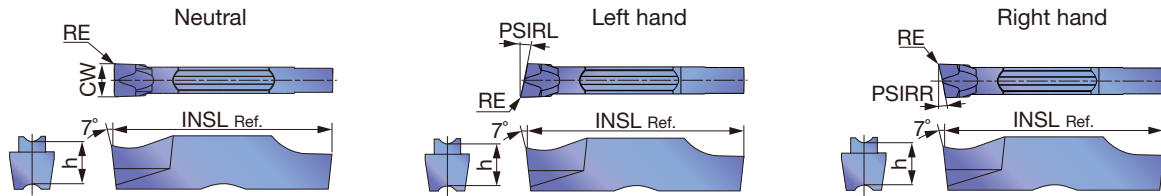

P	Steel	★	☆	★	☆	★								
M	Stainless	★	☆	★	★	★								
K	Cast iron	★		★	☆	★		☆						
N	Non-ferrous							☆						
S	Superalloys	★	☆	★				★						
H	Hard materials													

★ : First choice
☆ : Second choice

Designation	Seat size	HAND	CW±0.05	RE	Coated					Uncoated					INSL	h	PSIRL	PSIRR
					AH7025	AH725	AH8005	GH130	AH6235	KS05F								
SGS2-020	2	N	2	0.2	●	●	●	●	●	●					20	5	0°	0°
SGS2-020-6R	2	R	2	0.2	●	●	●	●							20	5	0°	6°
SGS2-020-6L	2	L	2	0.2	●	●	●	●							20	5	6°	0°
SGS2-020-15R	2	R	2	0.2	●	●	●	●							20	5	0°	15°
SGS2-020-15L	2	L	2	0.2	●	●	●	●							20	5	15°	0°
SGS3-020	3	N	3	0.2	●	●	●	●	●	●					20	5	0°	0°
SGS3-020-6R	3	R	3	0.2	●	●	●	●							20	5	0°	6°
SGS3-020-6L	3	L	3	0.2	●	●	●	●							20	5	6°	0°
SGS3-002-6R	3	R	3	0.02		●	●	●							19.8	5	0°	6°
SGS3-002-6L	3	L	3	0.02		●	●	●							19.8	5	6°	0°
SGS3-020-15R	3	R	3	0.2	●	●	●	●							20	5	0°	15°
SGS3-020-15L	3	L	3	0.2	●	●	●	●							20	5	15°	0°
SGS3-002-15R	3	R	3	0.02		●	●	●							19.8	5	0°	15°
SGS3-002-15L	3	L	3	0.02		●	●	●							19.8	5	15°	0°
SGS4-030	4	N	4	0.3	●	●	●	●	●	●					20	5	0°	0°
SGS5-030	5	N	5	0.3	●	●	●	●	●	●					25	5.5	0°	0°
SGS6-030	6	N	6	0.3	●	●	●	●	●	●					25	5.5	0°	0°
SGS8-040	8	N	8	0.4	●	●	●	●							30	6.7	0°	0°

●: Line up

DGL

External/internal grooving and parting

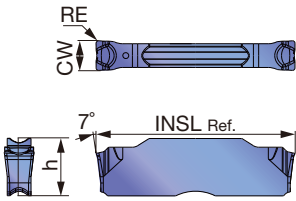

P	Steel	★	★	★																
M	Stainless	★	★	★																
K	Cast iron	★	★	★																
N	Non-ferrous																			
S	Superalloys	★	★																	
H	Hard materials																			

★ : First choice
☆ : Second choice

Designation	Seat size	CW±0.05	RE	Coated				INSL	h
				AH7025	AH8005	AH6235			
DGL2-020	2	2	0.2	●	●	●		20	5
DGL3-025	3	3	0.25	●	●	●		20	5
DGL4-030	4	4	0.3	●	●	●		20	5
DGL5-030	5	5	0.3	●	●	●		25	5.5
DGL6-080	6	6	0.8	●	●	●		25	5.5

● : Line up

DTE

External/internal/face grooving and turning (for high precision)

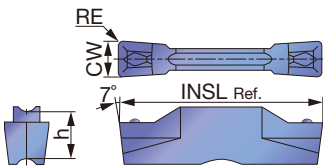

P	Steel	★	★	☆	☆																
M	Stainless		★	☆	★																
K	Cast iron		★		☆																
N	Non-ferrous																				
S	Superalloys		★	☆																	
H	Hard materials																				

★ : First choice
☆ : Second choice

Designation	Seat size	CW±0.02	RE	Coated				Cermet	INSL	h
				T9225	AH7025	AH725	GH130	NS9530		
DTE265-015	3	2.65	0.15	●	●	●	●	●	20	5
DTE300-020	3	3	0.2	●	●	●	●	●	20	5
DTE300-040	3	3	0.4	●	●	●	●	●	20	5
DTE315-015	3	3.15	0.15	●	●	●	●	●	20	5
DTE400-040	4	4	0.4	●	●	●	●	●	20	5
DTE400-080	4	4	0.8	●	●	●	●	●	20	5
DTE415-015	4	4.15	0.15	●	●	●	●	●	20	5
DTE478-055	5	4.78	0.55	●	●	●	●	●	25	5.5
DTE500-040	5	5	0.4	●	●	●	●	●	25	5.5
DTE500-080	5	5	0.8	●	●	●	●	●	25	5.5
DTE515-015	5	5.15	0.15	●	●	●	●		25	5.5
DTE600-080	6	6	0.8	●	●	●	●		25	5.5
DTE600-120	6	6	1.2	●	●	●	●		25	5.5
DTE800-080	8	8	0.8	●	●	●	●		30	6.7
DTE800-120	8	8	1.2	●	●	●	●		30	6.7

● : Line up

Reference pages: Toolholders → **F126**, Standard cutting conditions → **F145**

DTE

External/internal/face grooving and turning

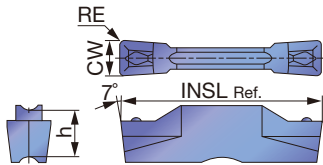

P	Steel	★		★	☆	★	☆	★	★				
M	Stainless			★	☆	★	★	★					
K	Cast iron		★	★		★	☆	★					
N	Non-ferrous												
S	Superalloys			★	☆	★							
H	Hard materials												

★ : First choice
☆ : Second choice

Designation	Seat size	CW±0.05	RE	Coated						Cermets		INSL	h
				T9225	T515	AH7025	AH725	AH8005	GH130	AH6235	NS9530		
DTE3-020	3	3	0.2			●		●		●		20	5
DTE3-040	3	3	0.4	●	●	●	●	●	●	●		20	5
DTE4-040	4	4	0.4	●	●	●	●	●	●	●		20	5
DTE4-080	4	4	0.8			●		●		●		20	5
DTE5-040	5	5	0.4		●	●		●		●		25	5.5
DTE5-080	5	5	0.8			●		●		●		25	5.5
DTE6-080	6	6	0.8		●	●		●		●		25	5.5

● : Line up

DGG

External/internal grooving (for high precision)

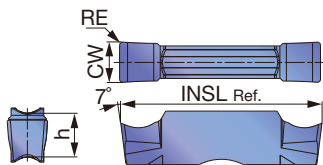

P	Steel	★			★								
M	Stainless	★											
K	Cast iron	★			☆			☆					
N	Non-ferrous							★					
S	Superalloys	★						☆					
H	Hard materials												

★ : First choice
☆ : Second choice

Designation	Seat size	CW±0.02	RE	Coated			Cermets		Uncoated		INSL	h
				AH7025			NS9530		KS05F			
DGG200-020	2	2	0.2	●			●		●		20	5
DGG300-020	3	3	0.2	●			●		●		20	5
DGG400-040	4	4	0.4	●			●		●		20	5
DGG500-040	5	5	0.4	●			●		●		25	5.5
DGG600-040	6	6	0.4	●			●		●		25	5.5

● : Line up

Reference pages: Toolholders → **F126**, Standard cutting conditions → **F145**

DTR

Profiling and undercutting (for high precision)

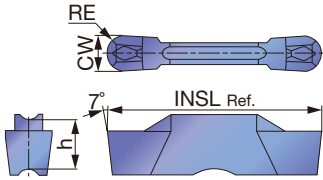

P	Steel	★	★	☆	☆				★				
M	Stainless		★	☆	★								
K	Cast iron		★		☆				☆				
N	Non-ferrous												
S	Superalloys		★	☆									
H	Hard materials												

★ : First choice
☆ : Second choice

Designation	Seat size	CW±0.02	RE	Coated				Cermet		INSL	h
				T9225	AH7025	AH725	GH130	NS9530			
DTR300-150	3	3	1.5	●	●	●	●	●		20	5
DTR400-200	4	4	2	●	●	●	●	●		20	5
DTR478-239	5	4.78	2.39	●	●	●	●	●		25	5.5
DTR500-250	5	5	2.5	●	●	●	●	●		25	5.5
DTR600-300	6	6	3	●	●	●	●			25	5.5

● : Line up

DTR

Profiling and undercutting

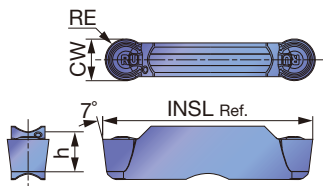

P	Steel	★	★	☆	★		☆	★		★			
M	Stainless		★	☆	★		★	★					
K	Cast iron		★		★	☆	☆	★		☆			
N	Non-ferrous									☆			
S	Superalloys		★	☆	★	★				★			
H	Hard materials												

★ : First choice
☆ : Second choice

Designation	Seat size	CW±0.05	RE	Coated						Cermet		Uncoated		INSL	h
				T9225	AH7025	AH725	AH8005	AH905	GH130	AH6235	NS9530		KS05F		
DTR2-100	2	2	1		●		●				●			20	5
DTR3-150	3	3	1.5	●	●	●	●	●	●	●				20	5
DTR4-200	4	4	2	●	●	●	●	●	●	●				20	5
DTR5-250	5	5	2.5	●	●	●	●	●	●	●				25	5.5
DTR6-300	6	6	3	●	●	●	●	●	●					25	5.5
DTR8-400	8	8	4	●	●	●	●	●	●					30	6.7

● : Line up

STR

Profiling and undercutting

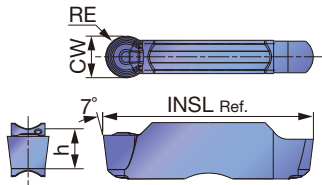

P	Steel	★	★																	
M	Stainless	★	★																	
K	Cast iron	★	★																	☆
N	Non-ferrous																			☆
S	Superalloys	★	★																	★
H	Hard materials																			

★ : First choice
☆ : Second choice

Designation	Seat size	CW±0.05	RE	Coated						Uncoated		INSL	h
				AH7025	AH8005					KS05F			
STR2-100	2	2	1	●	●					●		20	5
STR3-150	3	3	1.5	●	●					●		20	5
STR4-200	4	4	2	●	●					●		20	5
STR5-250	5	5	2.5	●	●					●		25	5.5
STR6-300	6	6	3	●	●					●		25	5.5
STR8-400	8	8	4	●	●					●		30	6.7

●: Line up

DTIU

Profiling and undercutting (for high precision)

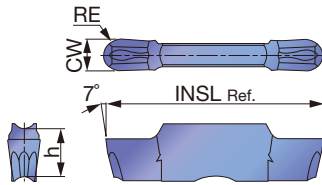

P	Steel	★	☆	☆																
M	Stainless	★	☆	★																
K	Cast iron	★		☆																
N	Non-ferrous																			
S	Superalloys	★	☆																	
H	Hard materials																			

★ : First choice
☆ : Second choice

Designation	Seat size	CW±0.02	RE	Coated									INSL	h	
				AH7025	AH725	GH130									
DTIU300-150	3	3	1.5	●	●	●								20	5
DTIU400-200	4	4	2	●	●	●								20	5
DTIU500-250	5	5	2.5	●	●	●								25	5.5
DTIU600-300	6	6	3	●	●	●								25	5.5

●: Line up

Reference pages: Toolholders → **F126**, Standard cutting conditions → **F145**

DTA

Aluminium wheel machining (for high precision)

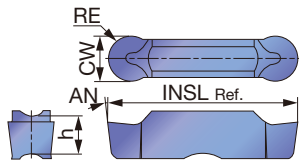

P	Steel								
M	Stainless								
K	Cast iron								
N	Non-ferrous	★							
S	Superalloys								
H	Hard materials								

★ : First choice
☆ : Second choice

Designation	Seat size	CW±0.02	RE	Uncoated						INSL	h	AN
				TH10								
DTA600-300	6	6	3	●						25	5.5	7°
DTA800-400	8	8	4	●						30	6.7	10°

●: Line up

STH

External/internal/face turning

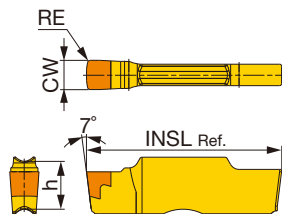

P	Steel								
M	Stainless								
K	Cast iron								
N	Non-ferrous								
S	Superalloys								
H	Hard materials	★							

★ : First choice

Designation	Seat size	CW±0.025	RE	CBN						INSL	h
				BXA10							
STH300-SR	3	3	0.3	●						20	5
STH500-SR	5	5	0.3	●						25	5.5

●: Line up

External/internal grooving

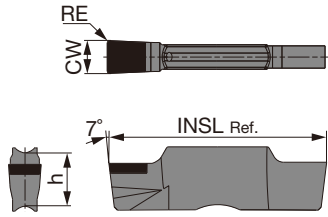

P	Steel										
M	Stainless										
K	Cast iron										
N	Non-ferrous										
S	Superalloys										
H	Hard materials	★									

★ : First choice
☆ : Second choice

Designation	Seat size	CW±0.025	RE	CBN								INSL	h	Condition		
				BX360											Continuous	Light interrupted
SGN200-020	2	2	0.2	●								20	5	○		
SGN200-020-S	2	2	0.2	●								20	5		○	
SGN200-020-H	2	2	0.2	●								20	5			○
SGN300-020	3	3	0.2	●								20	5	○		
SGN300-020-S	3	3	0.2	●								20	5		○	
SGN300-020-H	3	3	0.2	●								20	5			○
SGN400-020	4	4	0.2	●								20	5	○		
SGN400-020-S	4	4	0.2	●								20	5		○	
SGN400-020-H	4	4	0.2	●								20	5			○
SGN500-020-S	5	5	0.2	●								25	5.5			○
SGN500-020-H	5	5	0.2	●								25	5.5			○

●: Line up

Edge preparations

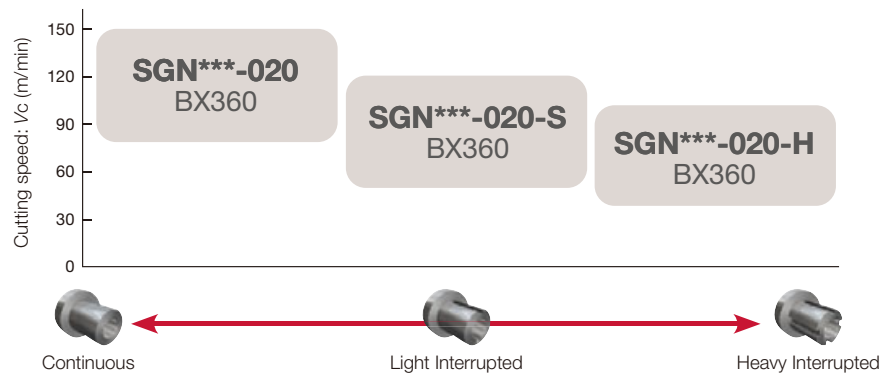
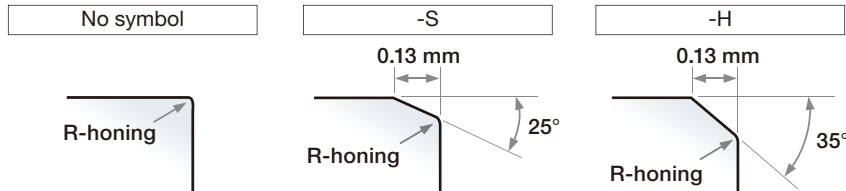

Reference pages: Toolholders → F126, Standard cutting conditions → F145

STANDARD CUTTING CONDITIONS

ISO	Workpiece material	Hardness	Priority	Grade	Cutting speed Vc (m/min)
P	Steel S45C, SCM435, etc. C45, 34CrMo4, etc.	< 300 HB	First choice	AH7025, AH725	50 - 180
		< 300 HB	Wear resistance	T9225, AH8005	80 - 300
		< 300 HB	Impact resistance	AH6235, GH130	50 - 120
		< 300 HB	Surface quality	NS9530	80 - 220
M	Stainless steel SUS303, SUS304, etc. X10CrNiS18-9, X5CrNi18-9, etc.	< 200 HB	First choice	AH7025, AH725	50 - 120
		< 200 HB	Wear resistance	AH8005	50 - 120
		< 200 HB	Impact resistance	AH6235, GH130	50 - 120
K	Grey cast iron FC250, etc. 250, etc.	-	First choice	T515	150 - 700
		-	Impact resistance	AH8005, AH7025, AH6235, GH130	50 - 180
	Ductile cast iron FCD450, etc. 450-10S, etc.	-	First choice	T515	150 - 300
		-	Impact resistance	AH8005, AH7025, AH6235, GH130	50 - 120
N	Aluminium alloys Si < 12%	-	First choice	TH10	100 - 500
		-	First choice	KS05F	100 - 600
S	Superalloys Inconel718, etc.	< HRC 40	First choice	AH8005	20 - 60
		< HRC 40	Impact resistance	AH7025, AH725, AH6235	20 - 40
	Titanium alloys Ti-6Al-4V, etc.	< HRC 40	First choice	KS05F	20 - 100
		< HRC 40	Impact resistance	AH7025, AH725	20 - 80

Please see page **F127 - F130** for feed: *f* (mm/rev).

STH

ISO	Grade	CW	Application	Cutting speed Vc (m/min)	Depth of cut ap (mm)	Feed f (mm/rev)
H	BXA10	3	External turning	100 - 230	0.08 - 0.12	0.4 - 1
			Face turning	100 - 230	0.08 - 0.12	0.4 - 0.8
		5	External turning	100 - 230	0.08 - 0.12	0.5 - 1.5
			Face turning	100 - 230	0.08 - 0.12	0.5 - 0.8

SGN

ISO	Grade	Edge preparation	Workpiece condition	Cutting speed Vc (m/min)	Feed f (mm/rev)
H	BX360	No symbol	Continuous	80 - 150	0.03 - 0.08
		-S	Light interrupted	50 - 120	0.03 - 0.08
		-H	Heavy interrupted	40 - 100	0.03 - 0.06

Grade
Insert
Ext. Toolholder
Int. Toolholder
Threading
Grooving
Miniature tool
Milling cutter
Endmill
Drilling tool
Tooling System
User's Guide
Index



MY-T SERIES

CGTR/L

Internal grooving and turning toolholder

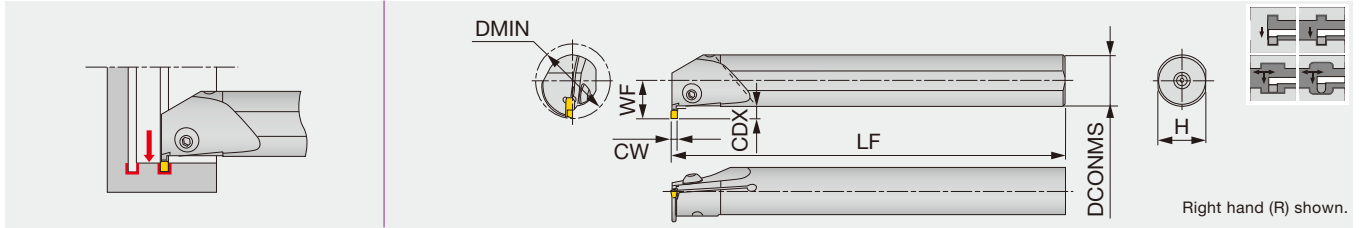

Designation	CW	DMIN	CDX	DCONMS	H	LF	WF	Insert	Torque*
S20Q-CGTR/L30	3	25	3.5	20	18	180	14.5	G*30, GE30-AL	3
S25R-CGTR/L30	3	32	5	25	23	200	18.5	G*30, GE30-AL	3
S25R-CGTR/L40	4	32	5	25	23	200	18.5	G*40, GE40-AL	3
S32S-CGTR/L40	4	40	6	32	30	250	23	G*40, GE40-AL	3
S25R-CGTR/L50	5	32	5	25	23	200	18.5	G*50	3
S32S-CGTR/L50	5	40	6	32	30	250	23	G*50	3

*Torque: Recommended clamping torque (N·m)

SPARE PARTS

Designation	Clamping screw	Wrench
S***-CGTR/L...	BHM5-14	P-3

External

Internal

Face

Parting

Others

Reference pages: Inserts → [F147 - F150](#), Standard cutting conditions → [F151](#)

Internal grooving

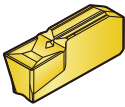
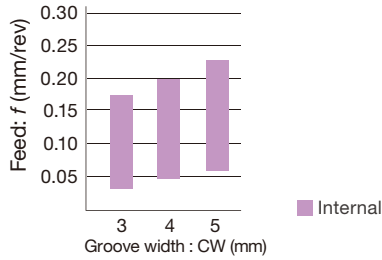
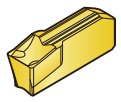
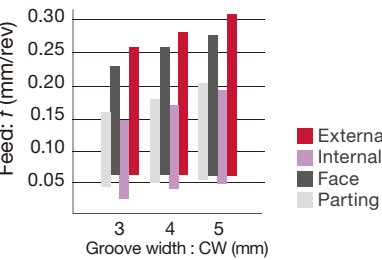
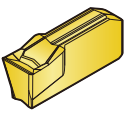
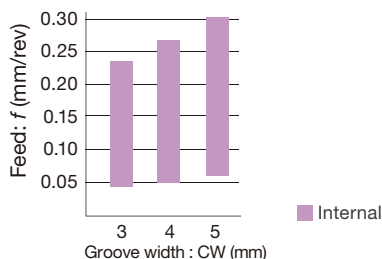
<p>GN</p>  <p>F150</p>	<p>1st choice for internal grooving Low cutting force and good chip control for internal grooving CW = 3 - 5 mm</p>	 <p>Feed: f (mm/rev)</p> <p>Groove width : CW (mm)</p> <p>Internal</p>
<p>GE</p>  <p>F148</p>	<p>1st choice for external grooving and parting Excellent chip control CW = 3 - 5 mm</p>	 <p>Feed: f (mm/rev)</p> <p>Groove width : CW (mm)</p> <p>External Internal Face Parting</p>
<p>GF</p>  <p>F149</p>	<p>1st choice for face grooving Low cutting force and good chip control for face grooving CW = 3 - 5 mm</p>	 <p>Feed: f (mm/rev)</p> <p>Groove width : CW (mm)</p> <p>Internal</p>

Grooving and turning

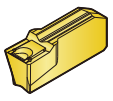
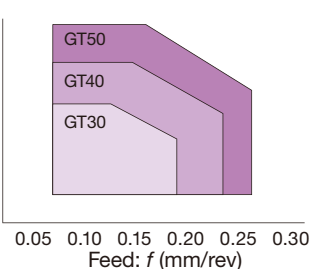
<p>GT</p>  <p>F148</p>	<p>1st choice for turning Low cutting force and good chip control for traversing CW = 3 - 5 mm</p>	 <p>Depth of cut: a_p (mm)</p> <p>Feed: f (mm/rev)</p> <p>GT50 GT40 GT30</p>
---	--	--

Profiling

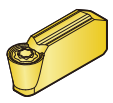
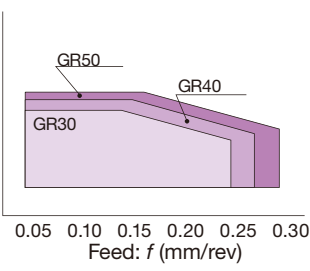
<p>GR</p>  <p>F149</p>	<p>Full radius type Low cutting force and good chip control for profiling CW = 3 - 5 mm</p>	 <p>Depth of cut: a_p (mm)</p> <p>Feed: f (mm/rev)</p> <p>GR50 GR40 GR30</p>
---	---	--

Please see page F*** for the product details.

For aluminium and non-ferrius metal

GE-AL

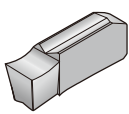

F150

Reduce cutting force and welding due to sharp chipbreaker

CW = 3 - 4 mm

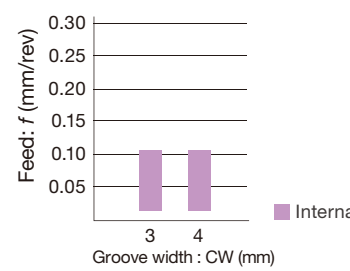

Feed: f (mm/rev)

Groove width : CW (mm)

Internal

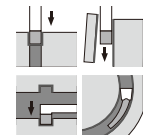

Please see page **F***** for the product details.

INSERTS

GE

For external grooving and parting

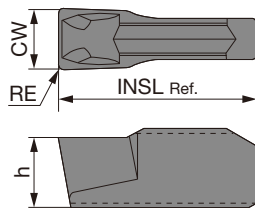

P	Steel	★	★	★					★						
M	Stainless		★	★											
K	Cast iron		★	☆					☆						
N	Non-ferrous														
S	Superalloys			☆											
H	Hard materials														

★ : First choice
☆ : Second choice

Designation	CW ^{+0.1} ₀	RE	Coated						Cermet		INSL	h	
			T9225	AH120	GH730				NS9530				
GE30	3	0.2	●	●	●					●		10	3.5
GE40	4	0.2	●	●	●					●		10	4
GE50	5	0.2	●	●	●					●		12	4.5

● : Line up

GT

For external grooving and turning

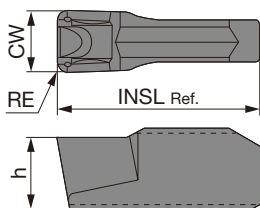

P	Steel	★	★	★					★						
M	Stainless		★	★											
K	Cast iron		★	☆					☆						
N	Non-ferrous														
S	Superalloys			☆											
H	Hard materials														

★ : First choice
☆ : Second choice

Designation	CW ^{+0.1} ₀	RE	Coated						Cermet		INSL	h	
			T9225	AH120	GH730				NS9530				
GT30	3	0.4		●	●					●		10	3.5
GT40	4	0.4		●	●					●		10	4
GT50	5	0.4	●	●	●					●		12	4.5

● : Line up

Reference pages: Toolholders → **F146**, Standard cutting conditions → **F151**

GR

For profiling (full radius)

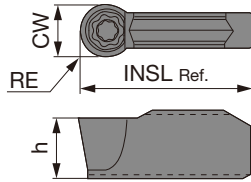

P	Steel	★	★	★				★					
M	Stainless		★	★									
K	Cast iron		★	☆				☆					
N	Non-ferrous												
S	Superalloys			☆									
H	Hard materials												

★ : First choice
☆ : Second choice

Designation	CW ^{+0.1} ₀	RE	Coated			Cermet			INSL	h
			T9225	AH120	GH730	NS9530				
GR30	3	1.5		●	●		●		10	3.5
GR40	4	2	●	●	●		●		10	4
GR50	5	2.5	●	●	●		●		12	4.5

● : Line up

GF

For face grooving

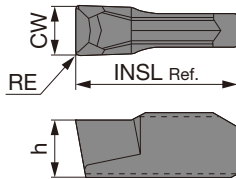

P	Steel	★			★								
M	Stainless		★										
K	Cast iron		☆		☆								
N	Non-ferrous												
S	Superalloys												
H	Hard materials												

★ : First choice
☆ : Second choice

Designation	CW ^{+0.1} ₀	RE	Coated	Cermet					INSL	h
			GH730	NS9530						
GF30	3	0.2	●	●					10	3.5
GF40	4	0.2	●	●					10	4
GF50	5	0.2	●	●					12	4.5

● : Line up

GN

For internal grooving

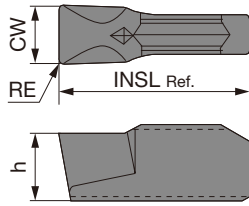

P	Steel	★								
M	Stainless	★								
K	Cast iron	☆								
N	Non-ferrous									
S	Superalloys									
H	Hard materials									

★ : First choice
☆ : Second choice

Designation	CW ^{+0.1} ₀	RE	Coated							INSL	h
			GH730								
GN30	3	0.2	●							10	3.5
GN40	4	0.2	●							10	4
GN50	5	0.2	●							12	4.5

● : Line up

GE-AL

For aluminium and non-ferrous metal

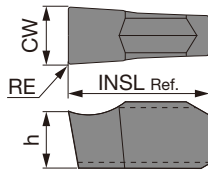

P	Steel									
M	Stainless									
K	Cast iron									
N	Non-ferrous	★								
S	Superalloys									
H	Hard materials									

★ : First choice
☆ : Second choice

Designation	CW ^{+0.1} ₀	RE	Uncoated							INSL	h
			KS05F								
GE30-AL	3	0.2	●							10	3.5
GE40-AL	4	0.2	●							10	4

● : Line up

Reference pages: Toolholders → **F146**, Standard cutting conditions → **F151**

STANDARD CUTTING CONDITIONS

ISO	Workpiece material	Grade	Cutting speed Vc (m/min)
P	Low carbon steel, Alloy steel (~ HB150)	T9225	80 - 300
		NS9530	100 - 200
		GH730, AH120	50 - 180
	Medium carbon steel, Alloy steel (HB150 ~ 250)	T9225	80 - 220
		NS9530	80 - 180
		GH730, AH120	50 - 150
	High carbon steel, Alloy steel (HB250 ~)	T9225	80 - 220
		NS9530	80 - 150
		GH730, AH120	50 - 120
M	Stainless steel	GH730, AH120	50 - 120
K	Grey iron, Ductile cast iron	GH730, AH120	50 - 180
N	Aluminium alloy, Non-ferrous metal	KS05F	200 - 300

Internal

Operation	Feed: f (mm/rev)		
	Groove width: CW (mm)		
	3	4	5
Internal grooving (GE**)	0.04 - 0.14	0.05 - 0.15	0.05 - 0.16
Internal grooving (GN**)	0.04 - 0.16	0.05 - 0.18	0.05 - 0.2
Internal traversing (GT**)	$a_p = 0.5 - 1.5$ $f = 0.06 - 0.2$	$a_p = 0.5 - 2$ $f = 0.06 - 0.25$	$a_p = 0.5 - 2.5$ $f = 0.06 - 0.27$
Internal traversing (GR**)	$a_p = 0.5 - 1.4$ $f = 0.05 - 0.25$	$a_p = 0.5 - 1.5$ $f = 0.05 - 0.26$	$a_p = 0.5 - 1.6$ $f = 0.05 - 0.3$
Aluminium alloys (GE** -AL)	0.03 - 0.1	0.03 - 0.1	-

For diameter compensation values in traversing, see page F115.

When vibration occurs in turning, please use the lower limit value in the above table

TUNGST-CLAMP

A_M-FLER/L

Internal grooving and threading toolholder

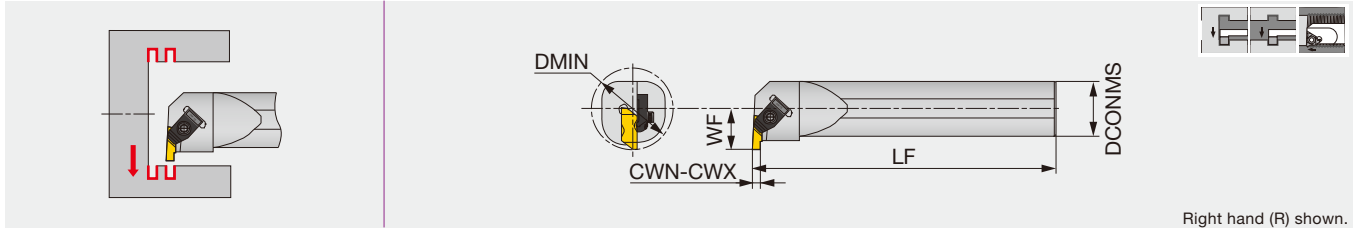

Right hand (R) shown.

Designation	CWN	CWX	DMIN	DCONMS	LF	WF	Insert	Torque*
A25M-FLER/L3	1	3	34.9	25	300	17.7	FL*-3**L/R...	3
A32M-FLER/L3	1	3	44.45	32	350	22.1	FL*-3**L/R...	3
A40M-FLER3	1	3	50.8	40	350	24.5	FL*-3**L...	3

Note: Use right-hand toolholders (R) with left-hand inserts (L); and left-hand toolholders (L) with right-hand inserts (R).
*Torque: Recommended clamping torque (N·m)

HS-FLER/L

Internal grooving and threading head, for S-570 shank

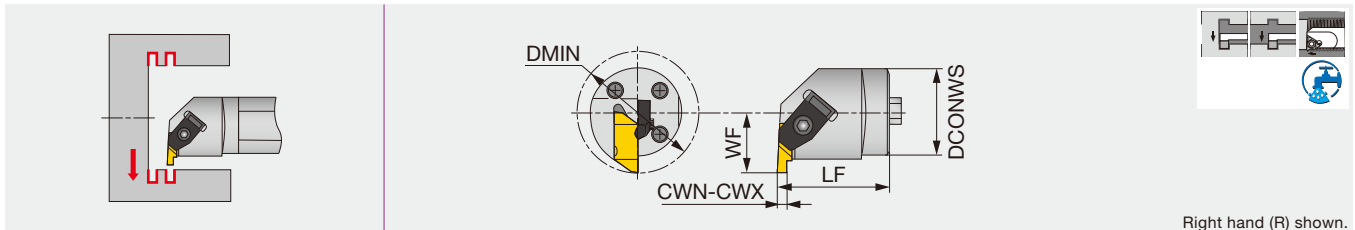

Right hand (R) shown.

Designation	CWN	CWX	DMIN	DCONWS	LF	WF	Insert	Torque*
HS40-FLER3W	1	3	56.1	40	40.1	28	FL*-3**L...	3
HS50-FLER3W	1	3	70.1	50	41.9	35	FL*-3**L...	3

Note: Use right-hand toolholders (R) with left-hand inserts (L).
*Torque: Recommended clamping torque (N·m)

SPARE PARTS

Designation	Clamp	Clamping screw	Wrench
A/HS**-FLER...	TF-73	S-412	5/32HEX
A**M-FLEL3	TF-72	S-412	5/32HEX

S-570

Steel shank for head exchangeable tools

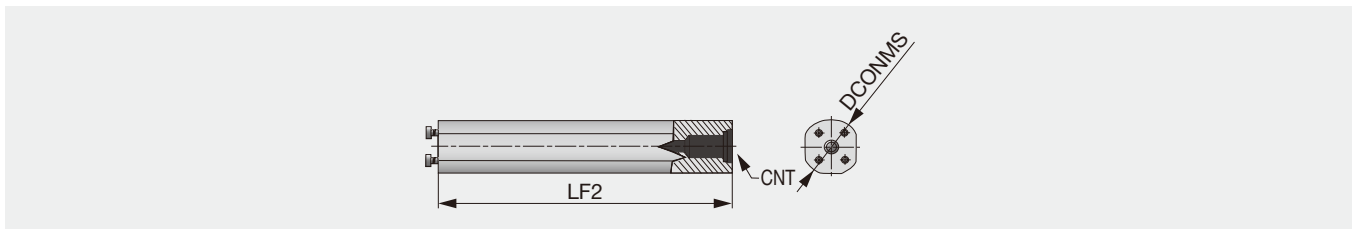

Designation	DCONMS	LF2	CNT
S-570-40M-40	40	273	1/2-14NPT
S-570-50M-50	50	366	1/2-14NPT

SPARE PARTS

Designation	Clamping screw	Wrench
S-570-40M-40	SS100	5/32HEX
S-570-50M-50	SS94	1/4HEX

INSERT

FLG-CB (For grooving)

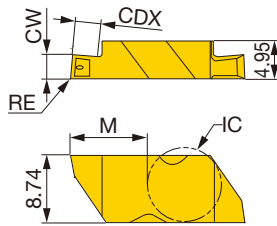

P	Steel	★						
M	Stainless	★						
K	Cast iron	★						
N	Non-ferrous							
S	Superalloys	☆						
H	Hard materials							

★ : First choice
☆ : Second choice

Designation	HAND	CW±0.025	RE	Coated						CDX	IC	M
				AH110								
FLG-3M100R-CB	R	1	0.19	●						1.4	9.525	10.29
FLG-3M100L-CB	L	1	0.19	●						1.4	9.525	10.29
FLG-3M150R-CB	R	1.5	0.19	●						2.55	9.525	10.29
FLG-3M150L-CB	L	1.5	0.19	●						2.55	9.525	10.29
FLG-3M200R-CB	R	2	0.19	●						2.55	9.525	10.29
FLG-3M200L-CB	L	2	0.19	●						2.55	9.525	10.29
FLG-3M250R-CB	R	2.5	0.19	●						4.07	9.525	10.29
FLG-3M250L-CB	L	2.5	0.19	●						4.07	9.525	10.29
FLG-3M300R-CB	R	3	0.19	●						4.07	9.525	10.29
FLG-3M300L-CB	L	3	0.19	●						4.07	9.525	10.29

● : Line up

STANDARD CUTTING CONDITIONS

ISO	Workpiece material	Grade	Application	Cutting Speed V _c (m/min)	Feed f (mm/rev)
P	High carbon steel S45C, etc. C45, etc.	AH110	Grooving	100 - 200	0.12 - 0.35
P	Alloy steel SCM435, etc. 34CrMo4, etc.	AH110	Grooving	50 - 80	0.12 - 0.3
M	Stainless steel SUS304, etc. X5CrNi18-9, etc.	AH110	Grooving	50 - 150	0.1 - 0.2
K	Grey cast iron FC250, etc. 250, etc.	AH110	Grooving	50 - 180	0.1 - 0.25
K	Ductile cast iron FCD400, etc. 40-15, etc.	AH110	Grooving	50 - 120	0.1 - 0.25

CNR/L

Internal threading and grooving toolholder (The -DT holders can be used either with the insert screw or top-clamp)

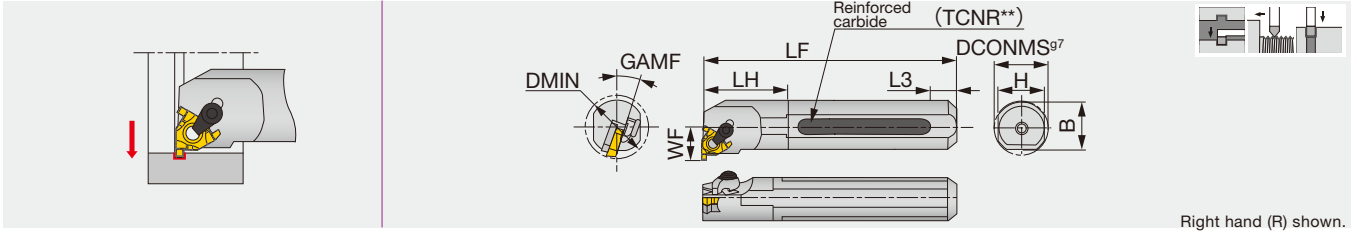

Designation	Material	CWN	CWX	DMIN	DCONMS	H	B	LF	LH	WF	L3	GAMF	Insert	Torque*
TCNR0020R16DT	Reinforced	1	2.25	24	20	18	-	200	30	14	49	15°	GTGN-16...	3.5
TCNR0025S16DT	Reinforced	1	2.25	29	25	23	-	250	38	16.5	64	15°	GTGN-16...	3.5
CNR/L0020P16	Steel	1	2.25	24	20	18	19	170	30	14	-	15°	GTGN-16...	3.5
CNR/L0025R16	Steel	1	2.25	29	25	23	24	200	38	16.5	-	15°	GTGN-16...	3.5
CNR/L0032S16	Steel	1	2.25	37	32	30	31	250	48	20.1	-	15°	GTGN-16...	3.5

Note: A clamp set consists of a clamp and a clamping screw.







A shim set consists of a shim and a shim screw to secure the shim to the toolholder.

Use right-hand toolholders (T/CNR...) with right-hand inserts (**IR...); and left-hand toolholders (T/CNL...) with left-hand inserts (**IL...).

Standard shims can be used on both right- and left-hand toolholders. Please use either of the sides depending on the tool hand.

When using grooving inserts, please use shims for grooving. Shims for grooving inserts are sold separately.

*Torque: Recommended clamping torque (N·m)

SPARE PARTS						
Designation	Clamp set	Clamping screw	Shim screw	Shim (Optional)	Wrench1	Wrench2
TCNR002**16DT	CSP16	CSTB-3.5ST	DTS5-3.5	G16EL/IR-DT	P-3.5	T-15F
CNR00***16	CSP16	-	-	G16EL/IR-S	-	T-15F
CNL00***16	CSP16	-	-	G16ER/IL-S	-	T-15F

INSERT

GTGN16

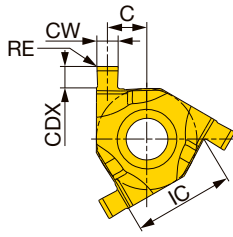

ER/IL shown.

P	Steel	★			
M	Stainless	★			
K	Cast iron				
N	Non-ferrous				
S	Superalloys	★			
H	Hard materials				

★ : First choice
☆ : Second choice

Designation	HAND (Internal)	CW±0.03	RE	Coated		Insert size	CDX	IC	C	Shim	
				SH730						Dual-clamp toolholder: screw-on and clamp-on	Clamp-on toolholder
GTGN-16ER/IL100	L	1	0.1	●		16	1.25	9.525	4.22	G16ER/IL-DT	G16ER/IL-S
GTGN-16EL/IR100	R	1	0.1	●		16	1.25	9.525	4.22	G16EL/IR-DT	G16EL/IR-S
GTGN-16ER/IL120	L	1.2	0.1	●		16	1.3	9.525	4.12	G16ER/IL-DT	G16ER/IL-S
GTGN-16EL/IR120	R	1.2	0.1	●		16	1.3	9.525	4.12	G16EL/IR-DT	G16EL/IR-S
GTGN-16ER/IL140	L	1.4	0.1	●		16	1.5	9.525	4.02	G16ER/IL-DT	G16ER/IL-S
GTGN-16EL/IR140	R	1.4	0.1	●		16	1.5	9.525	4.02	G16EL/IR-DT	G16EL/IR-S
GTGN-16ER/IL170	L	1.7	0.1	●		16	1.7	9.525	3.67	G16ER/IL-DT	G16ER/IL-S
GTGN-16EL/IR170	R	1.7	0.1	●		16	1.7	9.525	3.67	G16EL/IR-DT	G16EL/IR-S
GTGN-16ER/IL195	L	1.95	0.1	●		16	1.7	9.525	3.75	G16ER/IL-DT	G16ER/IL-S
GTGN-16EL/IR195	R	1.95	0.1	●		16	1.7	9.525	3.75	G16EL/IR-DT	G16EL/IR-S
GTGN-16ER/IL225	L	2.25	0.1	●		16	1.8	9.525	3.6	G16ER/IL-DT	G16ER/IL-S
GTGN-16EL/IR225	R	2.25	0.1	●		16	1.8	9.525	3.6	G16EL/IR-DT	G16EL/IR-S

Note: GTGN insert can be used for both external and internal machining, but the tool hand is reversed.
Shim for GTGN depends on the toolholder type.

● : Line up

STANDARD CUTTING CONDITIONS

ISO	Workpiece material	Grade	Cutting Speed Vc (m/min)	Feed f (mm/rev)
P	Steels S45C, SCM440, etc. C45, 42CrMo4, etc.	SH730	50 - 150	0.05 - 0.1
M	Stainless steels SUS304, SUS316, etc. X5CrNi18-9, X5CrNiMo17-12-2, etc.	SH730	30 - 150	0.05 - 0.1
S	Heat-resistant alloys, Titanium alloys etc. Ti-6Al-4V, etc.	SH730	30 - 100	0.05 - 0.1

S-SGTR/L

Internal grooving

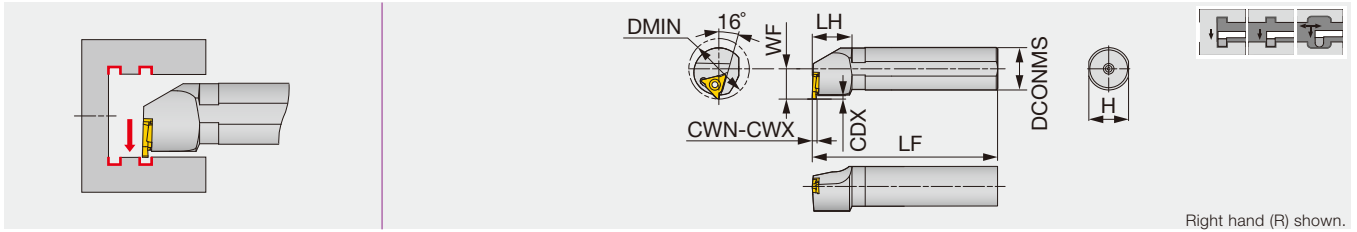

Right hand (R) shown.

Designation	CWN	CWX	DMIN	CDX	DCONMS	H	LF	LH	WF	Insert	Torque*
S25R-SGTR/L16	0.33	2.5	35	2	25	23	200	30	17.5	GBL/R32...	3.5
S32S-SGTR/L22	1.25	4.5	40	2.5	32	30	250	30	23	GBL/R43...	5

Use right-hand toolholders (SGTR) with left-hand inserts (GBL); and left-hand toolholders (SGTL) with right-hand inserts (GBR).
*Torque: Recommended clamping torque (N·m)

SPARE PARTS

Designation	Clamping screw	Wrench
S25R-SGTR/L16	CSTB-4S	T-15F
S32S-SGTR/L22	CSTB-5S	T-20F

INSERTS

GBR/L32

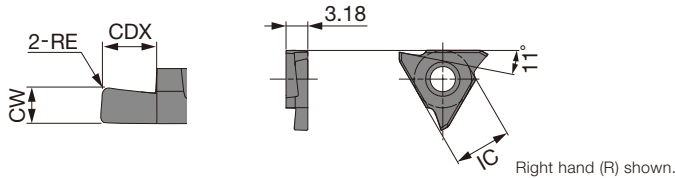

	P	M	K	N	S	H
Steel	★					
Stainless	★					
Cast iron	★		☆			
Non-ferrous				★		
Superalloys					☆	
Hard materials						

★ : First choice
☆ : Second choice

Designation	HAND	CW±0.025	RE	Coated			Cermet			Uncoated			CDX	IC
				AH710			NS9530			KS05F				
GBR32033	R	0.33	0.03	●			●						0.8	9.53
GBL32033	L	0.33	0.03	●									0.8	9.53
GBR32050	R	0.5	0.05	●			●						1.2	9.53
GBL32050	L	0.5	0.05	●									1.2	9.53
GBR32075	R	0.75	0.05	●			●						2	9.53
GBL32075	L	0.75	0.05	●			●						2	9.53
GBR32095	R	0.95	0.05	●			●						2	9.53
GBL32095	L	0.95	0.05	●			●						2	9.53
GBR32100	R	1	0.05	●			●						2	9.53
GBL32100	L	1	0.05	●			●						2	9.53
GBR32125	R	1.25	0.2	●			●						2	9.53
GBL32125	L	1.25	0.2	●			●						2	9.53
GBR32145	R	1.45	0.2	●			●						2	9.53
GBL32145	L	1.45	0.2	●			●						2	9.53
GBR32150	R	1.5	0.2	●			●						2	9.53
GBL32150	L	1.5	0.2	●			●						2	9.53
GBR32200	R	2	0.2	●			●						2.5	9.53
GBL32200	L	2	0.2	●			●						2.5	9.53
GBR32250	R	2.5	0.2	●			●						2.5	9.53
GBL32250	L	2.5	0.2	●			●						2.5	9.53

● : Line up

Reference pages: Inserts → **F156 - F158**, Standard cutting conditions → **F158**

GBR/L43

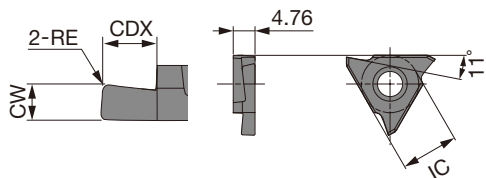

Right hand (R) shown.

P	Steel	★		★																
M	Stainless	★																		
K	Cast iron	★		☆																
N	Non-ferrous									★										
S	Superalloys	☆								☆										
H	Hard materials																			

★ : First choice
☆ : Second choice

Designation	HAND	CW±0.025	RE	Coated			Cermet			Uncoated			CDX	IC
				AH710			NS9530			KS05F				
GBR43125	R	1.25	0.2	●			●			●			2	12.7
GBL43125	L	1.25	0.2	●									2	12.7
GBR43145	R	1.45	0.2	●			●			●			2	12.7
GBL43145	L	1.45	0.2	●									2	12.7
GBR43150	R	1.50	0.2	●			●			●			3.5	12.7
GBL43150	L	1.50	0.2	●			●						3.5	12.7
GBR43175	R	1.75	0.2	●			●			●			3.5	12.7
GBL43175	L	1.75	0.2	●			●						3.5	12.7
GBR43185	R	1.85	0.2	●			●			●			3.5	12.7
GBL43185	L	1.85	0.2	●			●						3.5	12.7
GBR43200	R	2	0.2	●			●			●			3.5	12.7
GBL43200	L	2	0.2	●			●						3.5	12.7
GBR43230	R	2.3	0.2	●			●			●			3.5	12.7
GBL43230	L	2.3	0.2	●			●						3.5	12.7
GBR43250	R	2.5	0.3	●			●			●			5	12.7
GBL43250	L	2.5	0.3	●									5	12.7
GBR43265	R	2.65	0.3	●			●			●			5	12.7
GBL43265	L	2.65	0.3	●									5	12.7
GBR43280	R	2.8	0.3	●			●			●			5	12.7
GBL43280	L	2.8	0.3	●									5	12.7
GBR43300	R	3	0.3	●			●			●			5	12.7
GBL43300	L	3	0.3	●									5	12.7
GBR43330	R	3.3	0.3	●			●			●			5	12.7
GBL43330	L	3.3	0.3	●									5	12.7
GBR43350	R	3.5	0.3	●			●			●			5	12.7
GBL43350	L	3.5	0.3	●									5	12.7
GBR43400	R	4	0.4	●			●			●			5	12.7
GBL43400	L	4	0.4	●									5	12.7
GBR43430	R	4.3	0.4	●			●			●			5	12.7
GBL43430	L	4.3	0.4	●									5	12.7
GBR43450	R	4.5	0.4	●			●			●			5	12.7
GBL43450	L	4.5	0.4	●									5	12.7

● : Line up



GBR/L43-R (full radius)

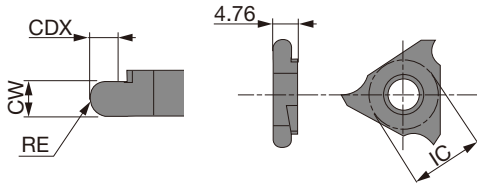

Right hand (R) shown.

P	Steel	★		★							
M	Stainless	★									
K	Cast iron	★		☆							
N	Non-ferrous							★			
S	Superalloys	☆						☆			
H	Hard materials										

★ : First choice
☆ : Second choice

Designation	HAND	CW±0.025	RE	Coated			Cermet			Uncoated			CDX	IC
				AH710	NS9530	KS05F								
GBR43050R	R	1	0.5	●	●	●							2	12.7
GBL43050R	L	1	0.5	●			●						2	12.7
GBR43075R	R	1.5	0.75	●	●	●							3.5	12.7
GBL43075R	L	1.5	0.75	●			●						3.5	12.7
GBR43100R	R	2	1	●	●	●							3.5	12.7
GBL43100R	L	2	1	●			●						3.5	12.7
GBR43125R	R	2.5	1.25	●	●	●							5	12.7
GBL43125R	L	2.5	1.25	●			●						5	12.7
GBR43150R	R	3	1.5	●	●	●							5	12.7
GBL43150R	L	3	1.5	●			●						5	12.7
GBR43200R	R	4	2	●	●	●							5	12.7
GBL43200R	L	4	2	●			●						5	12.7

● : Line up

STANDARD CUTTING CONDITIONS

ISO	Workpiece material	Hardness	Grade	Cutting speed Vc (m/min)	Feed f (mm/rev)
P	Carbon steels, Alloy steels S45C, SCM415, etc. C45, 18CrMo4, etc.	150 - 240HB	NS9530	100 - 200	0.02 - 0.25
		150 - 240HB	AH710	60 - 150	0.05 - 0.25
M	Stainless steels SUS304, etc. X5CrNi18-9, etc.	≤ 240HB	AH710	60 - 150	0.05 - 0.15
K	Cast irons FC250, etc. 250, etc.	Tensile strength ≤ 350 N/mm ²	AH710	60 - 150	0.05 - 0.15
N	Non-ferrous metals Aluminium, etc.	-	KS05F	200 - 300	0.05 - 0.15

Reference pages: Toolholders → **F156**

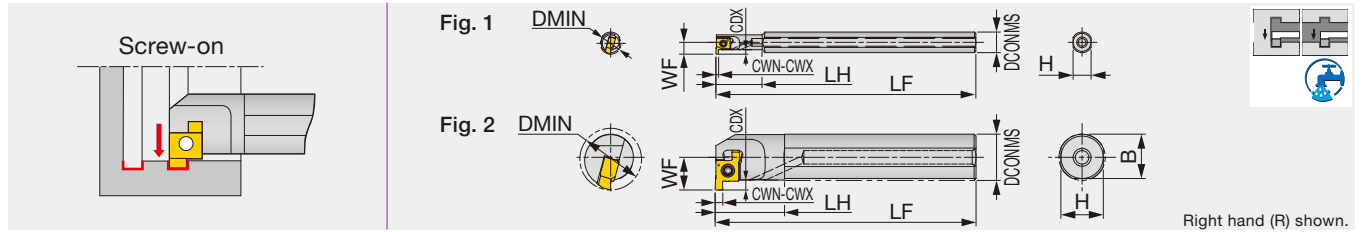

Designation	Material	CWN	CWX	DMIN	CDX	DCONMS	H	B	LF	LH	WF	Insert	Torque* Fig.
A08H-SNGR06-D080	Steel	1	2	8	1.5	8	7	-	100	18	4.73	6GMR..., 6GR...	0.7 1
A08H-SNGR07-D100	Steel	1	2	10	1.5	8	7	-	100	23	5.8	7GMR..., 7GR...	1.0 1
A10K-SNGR07-D120	Steel	1	2	12	1.5	10	9	-	125	29	6.8	7GMR..., 7GR...	1.0 1
A10K-SNGR08-D140	Steel	1.5	3.5	14	2	10	9	-	125	15	7.6	8GMR..., 8GR...	1.0 2
A12M-SNGR08-D160	Steel	1.5	3.5	16	2	12	11	11.5	150	18	8.6	8GMR..., 8GR...	1.0 2
A16Q-SNGR09-D200	Steel	1.5	3.5	20	3	16	15	15.5	180	20	11.6	9GMR..., 9GR...	1.3 2
A20R-SNGR09-D240	Steel	1.5	3.5	24	3	20	18	19	200	25	13.6	9GMR..., 9GR...	1.3 2
E08X-SNGR07-D100	Carbide	1	2	10	1.5	8	7.5	-	120.5	35	5.8	7GMR..., 7GR...	1.0 1
E10X-SNGR07-D120	Carbide	1	2	12	1.5	10	9	-	143.5	45	6.8	7GMR..., 7GR...	1.0 1
E10X-SNGR08-D140	Carbide	1.5	3.5	14	2	10	9	-	146	-	7.6	8GMR..., 8GR...	1.0 2
E12X-SNGR08-D160	Carbide	1.5	3.5	16	2	12	11	-	174.8	-	8.6	8GMR..., 8GR...	1.0 2
E16X-SNGR09-D200	Carbide	1.5	3.5	20	3	16	15	-	194.6	-	11.6	9GMR..., 9GR...	1.5 2

Note: Use the right-hand insert (□GR) with the right-hand holder (□NGR).
*Torque: Recommended clamping torque (N·m)

SPARE PARTS

Designation	Clamping screw	Wrench
A**-SNGR06-D...	CSTB-2L040	T-6F
A**-SNGR07-D...	CSTB-2.2S	T-7F
A**-SNGR08-D...	CSTB-2.2	T-7F
A**-SNGR09-D...	CSTB-2.5L080	T-8F
E**-SNGR07-D...	CSTB-2.2S	T-7F
E**-SNGR08-D...	CSTB-2.2	T-7F
E**-SNGR09-D...	CSTB-2.5L080	T-8F



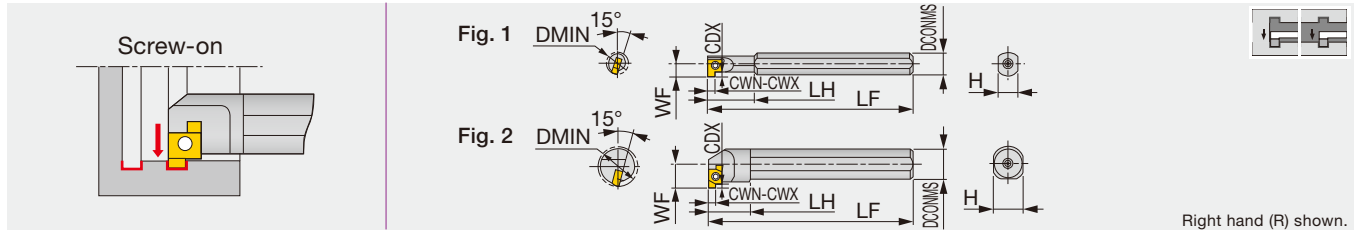

Right hand (R) shown.

Designation	Material	CWN	CWX	DMIN	CDX	DCONMS	H	LF	LH	WF	Insert	Torque*	Fig.
SNGR/L08H06	Steel	1	2	8	1.5	8	7	100	18	4.7	6GMR..., 6GR/L...	0.7	1
SNGR/L08H07	Steel	1	2	10	1.5	8	7	100	23	5.8	7GMR..., 7GR/L...	1.0	1
SNGR/L10K07	Steel	1	2	12	1.5	10	9	125	29	6.8	7GMR..., 7GR/L...	1.0	1
SNGR/L10K08	Steel	1.5	3.5	14	2	10	9	125	15	7.6	8GMR..., 8GR/L...	1.0	2
SNGR/L12M08	Steel	1.5	3.5	16	2	12	11	150	18	8.6	8GMR..., 8GR/L...	1.0	2
SNGR/L16Q09	Steel	1.5	3.5	20	3	16	15	180	20	11.6	9GMR..., 9GR/L...	1.3	2
SNGR/L20R09	Steel	1.5	3.5	24	3	20	18	200	25	13.6	9GMR..., 9GR/L...	1.3	2
SNGR/L08K06SC	Carbide	1	2	8	1.5	8	7	125	28	4.7	6GMR..., 6GR/L...	0.7	1
SNGR/L08K07SC	Carbide	1	2	10	1.5	8	7	125	35	5.8	7GMR..., 7GR/L...	1.0	1
SNGR/L10M07SC	Carbide	1	2	12	1.5	10	9	150	45	6.8	7GMR..., 7GR/L...	1.0	1
SNGR/L10M08SC	Carbide	1.5	3.5	14	2	10	9	150	45	7.6	8GMR..., 8GR/L...	1.0	2
SNGR/L12Q08SC	Carbide	1.5	3.5	16	2	12	11	180	-	8.6	8GMR..., 8GR/L...	1.0	2
SNGR/L16R09SC	Carbide	1.5	3.5	20	3	16	15	200	-	11.6	9GMR..., 9GR/L...	1.5	2

Note: Use the right-hand insert (□GR) with the right-hand holder (□NGR), and use the left-hand insert (□GL) with the left-hand holder (□NGL).

*Torque: Recommended clamping torque (N·m)

SPARE PARTS

Designation	Clamping screw	Wrench
SNGR/L***06	CSTB-2L040	T-6F
SNGR/L***07	CSTB-2.2S	T-7F
SNGR/L***08	CSTB-2.2	T-7F
SNGR/L***09	CSTB-2.5L080	T-8F
SNGR/L***06SC	CSTB-2L040	T-6F
SNGR/L***07SC	CSTB-2.2S	T-7F
SNGR/L***08SC	CSTB-2.2	T-7F
SNGR/L***09SC	CSTB-2.5L080	T-8F

CNGR/L

Toolholders for internal grooving

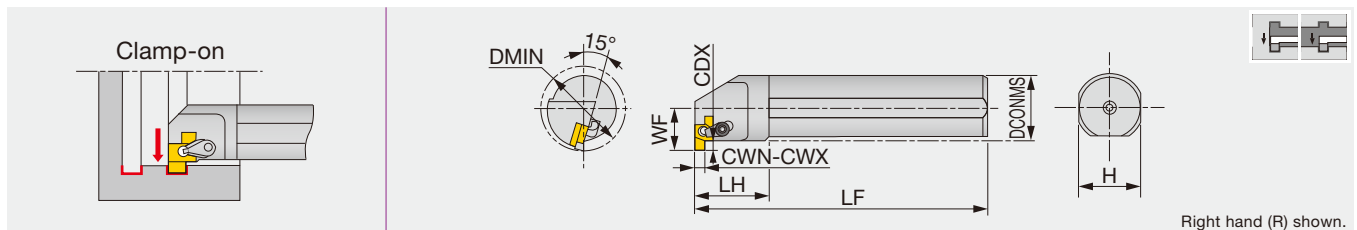

Right hand (R) shown.

Designation	CWN	CWX	DMIN	CDX	DCONMS	H	LF	LH	WF	Insert	Torque*
CNGR/L25S15	2	5	32	5	25	23	250	30	18.1	15GR/L...	7
CNGR/L32T15	2	5	40	5	32	30	300	35	22.1	15GR/L...	7
CNGR/L40U15	2	5	48	5	40	38	350	45	26.1	15GR/L...	7

Note: Use the right-hand insert (□GR) with the right-hand holder (□NGR), and use the left-hand insert (□GL) with the left-hand holder (□NGL).

*Torque: Recommended clamping torque (N·m)

Optional parts for CNG holders

Use the following parts for screw clamp options.

SPARE PARTS

Designation	Clamp set	Screw	Shim	Wrench
CNGR...	CSP22	DTS5-3.5	SGSR151	T-20F
CNGL...	CSP22	DTS5-3.5	SGSL151	T-20F

Designation	Clamping screw	Wrench
CNGR/L...	CSTB-3.5L	T-15F

Reference pages: Inserts → **F161, F162**, Standard cutting conditions → **F163**

INSERTS

**GMR/L

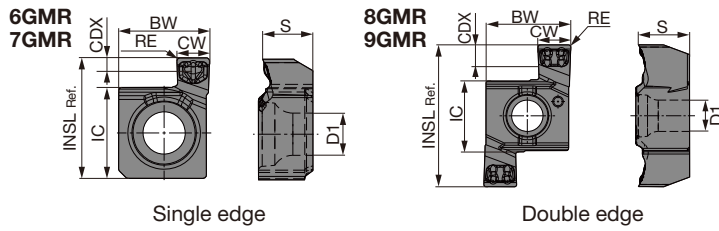

Single edge

Double edge

Right hand (R) shown.

P	Steel	★									
M	Stainless	★									
K	Cast iron	★									
N	Non-ferrous										
S	Superalloys	★									
H	Hard materials										

★ : First choice
☆ : Second choice

Designation	HAND	CW±0.025	RE	Coated					CDX	BW	S	IC	INSL	D1
				AH7025										
6GMR100-015	R	1	0.15	●					1.5	5.56	2.34	4.76	6.4	2.3
7GMR200-020	R	2	0.2	●					1.5	5.56	3.08	5.56	7.4	2.6
8GMR150-020	R	1.5	0.2	●					2	6.15	3.87	5.56	10.2	2.6
9GMR200-020	R	2	0.2	●					3	7.74	4.66	6.35	13	2.9
9GMR300-020	R	3	0.2	●					3	7.74	4.66	6.35	13	2.9

● : Line up

Grade
Insert
Ext. Toolholder
Int. Toolholder
Threading
Grooving
Miniature tool
Milling cutter
Endmill
Drilling tool
Tooling System
User's Guide
Index



****GR/L**

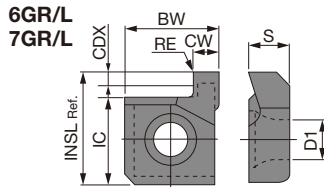

Single edge

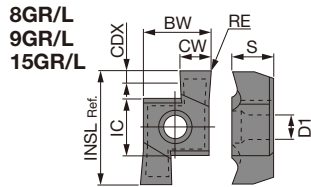

Double edge

Right hand (R) shown.

P	Steel	★			★					
M	Stainless				★					
K	Cast iron	☆			★					
N	Non-ferrous				★					
S	Superalloys				☆					
H	Hard materials									

★ : First choice
☆ : Second choice

Designation	HAND	CW±0.025	RE	Cermet		Uncoated		CDX	BW	S	IC	INSL	D1
				NS9530		TH10	UX30						
6GR100	R	1	0.2	●		●		1.5	5.6	2.34	4.76	6.4	2.3
6GL100	L	1	0.2			●	●	1.5	5.6	2.34	4.76	6.4	2.3
6GR150	R	1.5	0.2	●		●	●	1.5	5.6	2.34	4.76	6.4	2.3
6GL150	L	1.5	0.2			●	●	1.5	5.6	2.34	4.76	6.4	2.3
6GR200	R	2	0.2	●		●	●	1.5	5.6	2.34	4.76	6.4	2.3
6GL200	L	2	0.2			●	●	1.5	5.6	2.34	4.76	6.4	2.3
7GR100	R	1	0.2	●		●	●	1.5	5.6	3.08	5.56	7.4	2.6
7GR150	R	1.5	0.2	●		●	●	1.5	5.6	3.08	5.56	7.4	2.6
7GR200	R	2	0.2	●		●	●	1.5	5.6	3.08	5.56	7.4	2.6
7GL200	L	2	0.2			●	●	1.5	5.6	3.08	5.56	7.4	2.6
8GR150	R	1.5	0.2	●		●	●	2	6.2	3.87	5.56	10.2	2.6
8GR200	R	2	0.2	●		●	●	2	6.2	3.87	5.56	10.2	2.6
8GL200	L	2	0.2			●	●	2	6.2	3.87	5.56	10.2	2.6
8GR250	R	2.5	0.2	●		●	●	2	6.2	3.87	5.56	10.2	2.6
8GL250	L	2.5	0.2			●	●	2	6.2	3.87	5.56	10.2	2.6
8GR300	R	3	0.2	●		●	●	2	6.2	3.87	5.56	10.2	2.6
8GL300	L	3	0.2			●	●	2	6.2	3.87	5.56	10.2	2.6
8GR350	R	3.5	0.2	●		●	●	2	6.2	3.87	5.56	10.2	2.6
9GR150	R	1.5	0.2	●		●	●	2	7.7	4.66	6.35	13	2.9
9GL150	L	1.5	0.2	●			●	2	7.7	4.66	6.35	13	2.9
9GR200	R	2	0.2	●		●	●	3	7.7	4.66	6.35	13	2.9
9GL200	L	2	0.2	●		●	●	3	7.7	4.66	6.35	13	2.9
9GR250	R	2.5	0.2	●		●	●	3	7.7	4.66	6.35	13	2.9
9GL250	L	2.5	0.2	●			●	3	7.7	4.66	6.35	13	2.9
9GR300	R	3	0.2	●		●	●	3	7.7	4.66	6.35	13	2.9
9GL300	L	3	0.2	●		●	●	3	7.7	4.66	6.35	13	2.9
9GR350	R	3.5	0.2	●		●	●	3	7.7	4.66	6.35	13	2.9
9GL350	L	3.5	0.2	●			●	3	7.7	4.66	6.35	13	2.9
15GR200	R	2	0.2	●		●	●	3	10.8	5.1	9.2	20.8	4.8
15GR250	R	2.5	0.2	●		●	●	3	10.8	5.1	9.2	20.8	4.8
15GR300	R	3	0.2	●		●	●	3	10.8	5.1	9.2	20.8	4.8
15GL300	L	3	0.2				●	3	10.8	5.1	9.2	20.8	4.8
15GR350	R	3.5	0.2	●		●	●	3	10.8	5.1	9.2	20.8	4.8
15GR400	R	4	0.2	●		●	●	4	10.8	5.1	9.2	20.8	4.8
15GR450	R	4.5	0.2	●		●	●	4	10.8	5.1	9.2	20.8	4.8
15GL450	L	4.5	0.2			●	●	4	10.8	5.1	9.2	20.8	4.8
15GR500	R	5	0.2	●		●	●	5	10.8	5.1	9.2	20.8	4.8

Note: Use the right-hand insert (□GR) with the right-hand holder (□NGR), and use the left-hand insert (□GL) with the left-hand holder (□NGL).

● : Line up

Reference pages: Toolholders → **F159, F160**

STANDARD CUTTING CONDITIONS

ISO	Workpiece material	Grade	Cutting speed Vc (m/min)	Feed rate: f (mm/rev)	
				**GMR...	**GR/L...
P	Carbon steel S45C, C45, etc.	AH7025	80 - 180	0.03 - 0.12	-
		NS9530	80 - 200	-	0.05 - 0.15
		UX30	40 - 150	-	0.05 - 0.15
	Alloy steel SCM435, 34CrMo4, etc.	AH7025	80 - 180	0.03 - 0.12	-
		NS9530	80 - 200	-	0.05 - 0.15
		UX30	40 - 150	-	0.05 - 0.15
M	Stainless steel SUS304, X5CrNi18-9, etc.	AH7025	50 - 120	0.03 - 0.12	-
		UX30	40 - 100	-	0.03 - 0.10
K	Grey cast irons F250, GG25, 250, etc.	AH7025	50 - 220	0.03 - 0.12	-
		TH10	60 - 200	-	0.05 - 0.15
	Ductile cast irons FCD400, etc.	AH7025	50 - 180	0.03 - 0.12	-
		TH10	40 - 160	-	0.05 - 0.15
S	Titanium alloys Ti-6Al-4V, etc.	AH7025	30 - 80	0.03 - 0.12	-
		TH10	20 - 50	-	0.05 - 0.08
	Superalloys Inconel718, etc.	AH7025	20 - 40	0.03 - 0.12	-
		TH10	10 - 30	-	0.03 - 0.08

Grade
Insert
Ext. Toolholder
Int. Toolholder
Threading
Grooving
Miniature tool
Milling cutter
Endmill
Drilling tool
Tooling System
User's Guide
Index



CGXR/L

Internal grooving

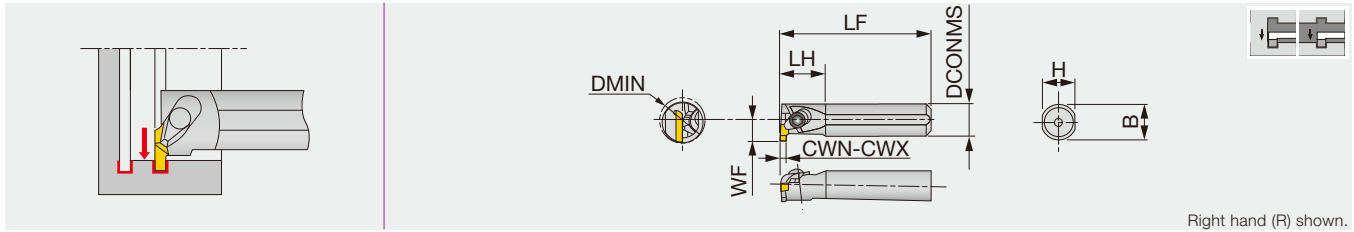

Designation	Material	CWN	CWX	DMIN	CDX	DCONMS	H	B	LF	LH	WF	Insert	Torque*
CGXR/L0016	Steel	1	3	20	3	16	15	15.5	150	24	11.3	GIR/L52...	2.2
CGXR/L0020	Steel	1	3	24	3	20	18	19	180	30	13.3	GIR/L52...	2.2
CGXR/L0025	Steel	1	5	32	5.3	25	23	24	200	38	18	GIR/L63...	5
CGXR/L0032	Steel	1	5	40	5.3	32	30	31	250	48	23	GIR/L63...	5
CGXR/L0040	Steel	1	5	48	5.3	40	37	38.5	300	60	27	GIR/L63...	5
CGXR/L16SC	Carbide	1	3	20	3	16	15	-	200	24	11.3	GIR/L52...	2.2

Note: Use right-hand holder (CGXR) with right-hand insert (GIR); and left-hand holder (L) with left-hand insert (GIL).
*Torque: Recommended clamping torque (N·m)

SPARE PARTS			
Designation	Clamp set	Wrench1	Wrench2
CGXR/L0016/20	CSW-0	-	P-2.5T
CGXR/L0025/32/40	CSW-2	P-4	-
CGXR/L16SC	CSW-0	-	P-2.5T



INSERT

GIR/L

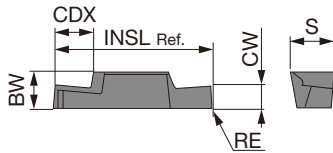

Right hand (R) shown.

P	Steel	★							
M	Stainless				☆				
K	Cast iron	☆			★				
N	Non-ferrous				★				
S	Superalloys				☆				
H	Hard materials								

★ : First choice
☆ : Second choice

Designation	HAND	CW±0.05	RE	Cermets		Uncoated				CDX	INSL	BW	S
				NS9530	TH10								
GIR5210-02	R	1	0.2	●	●					1.5	15	3.5	4.4
GIL5210-02	L	1	0.2	●	●					1.5	15	3.5	4.4
GIR5215-02	R	1.5	0.2	●	●					2.3	15	3.5	4.4
GIL5215-02	L	1.5	0.2	●	●					2.3	15	3.5	4.4
GIR5220-02	R	2	0.2	●	●					3	15	3.5	4.4
GIL5220-02	L	2	0.2	●	●					3	15	3.5	4.4
GIR5225-02	R	2.5	0.2	●	●					3	15	3.5	4.4
GIL5225-02	L	2.5	0.2	●	●					3	15	3.5	4.4
GIR5230-02	R	3	0.2	●	●					3	15	3.5	4.4
GIL5230-02	L	3	0.2	●	●					3	15	3.5	4.4
GIR6310-02	R	1	0.2	●	●					1.5	24	5.5	6.4
GIL6310-02	L	1	0.2	●	●					1.5	24	5.5	6.4
GIR6315-02	R	1.5	0.2	●	●					2.3	24	5.5	6.4
GIL6315-02	L	1.5	0.2	●	●					2.3	24	5.5	6.4
GIR6320-02	R	2	0.2	●	●					3	24	5.5	6.4
GIL6320-02	L	2	0.2	●	●					3	24	5.5	6.4
GIR6325-02	R	2.5	0.2	●	●					3.8	24	5.5	6.4
GIL6325-02	L	2.5	0.2	●	●					3.8	24	5.5	6.4
GIR6330-02	R	3	0.2	●	●					4.5	24	5.5	6.4
GIL6330-02	L	3	0.2	●	●					4.5	24	5.5	6.4
GIR6335-02	R	3.5	0.2	●	●					5.3	24	5.5	6.4
GIL6335-02	L	3.5	0.2	●	●					5.3	24	5.5	6.4
GIR6340-02	R	4	0.2	●	●					5.3	24	5.5	6.4
GIL6340-02	L	4	0.2	●	●					5.3	24	5.5	6.4
GIR6345-02	R	4.5	0.2	●	●					5.3	24	5.5	6.4
GIL6345-02	L	4.5	0.2	●	●					5.3	24	5.5	6.4
GIR6350-02	R	5	0.2	●	●					5.3	24	5.5	6.4
GIL6350-02	L	5	0.2	●	●					5.3	24	5.5	6.4

Use right-hand toolholders (CGXR~) with right-hand inserts (GIR); and left-hand toolholders (GX-****L) with left-hand inserts (XGR).

● : Line up

STANDARD CUTTING CONDITIONS

ISO	Workpiece material	Grade	Cutting speed Vc (m/min)	Feed f (mm/rev)		
				W < 2 mm	W = 2 ~ 4 mm	W > 4 mm
P	Carbon steels	NS9530	80 - 150	0.05 - 0.1	0.08 - 0.15	0.08 - 0.2
K	Cast irons, Light alloys	TH10	60 - 150	0.05 - 0.1	0.08 - 0.15	0.08 - 0.2

GX-R/LI

Internal grooving

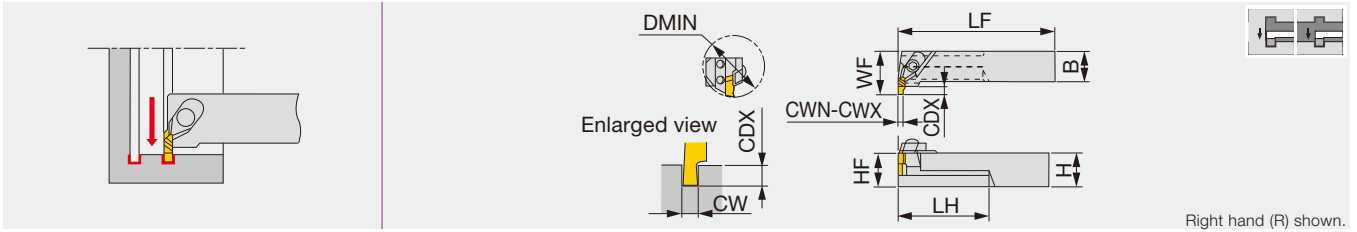

Designation	CWN	CWX	DMIN	CDX	H	B	LF	LH	HF	WF	Insert	Torque*
GX-2525R/LI	1	4.5	55	1.5 - 6	25	25	200	70	25	35	XGL/R63...	5

Use right-hand toolholders (GX-****R) with left-hand inserts (XGL...); and left-hand toolholders (GX-****L) with right-hand inserts (XGR...).

*Torque: Recommended clamping torque (N·m)

SPARE PARTS

Designation	Clamp set	Clamp screw	Shim	Shim screw	Wrench
GX-2525RI	CP81B	RT-1	SL-2R	BHM3-8	P-4
GX-2525LI	CP81B	RT-1	SL-2L	BHM3-8	P-4

Note: Max. groove width and max. groove depth will depend on the insert type.

INSERT

XGR/L

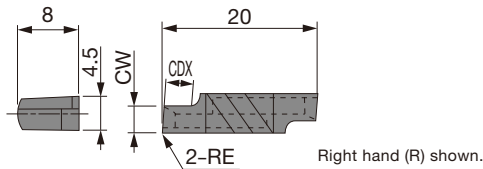

P	Steel	★		☆	★					
M	Stainless				★					
K	Cast iron	☆		★						
N	Non-ferrous			★						
S	Superalloys			☆						
H	Hard materials									

★ : First choice
☆ : Second choice

Designation	HAND	CW±0.025	RE	Cermet		Uncoated		CDX
				NS9530	TH10	UX30		
XGR6310-02	R	1	0.2	●	●	●		1.5
XGL6310-02	L	1	0.2	●	●	●		1.5
XGR6315-02	R	1.5	0.2	●	●	●		2.3
XGL6315-02	L	1.5	0.2	●	●	●		2.3
XGR6320-02	R	2	0.2	●	●	●		3
XGL6320-02	L	2	0.2	●	●	●		3
XGR6325-02	R	2.5	0.2	●	●	●		3.8
XGL6325-02	L	2.5	0.2	●	●	●		3.8
XGR6330-02	R	3	0.2	●	●	●		4.5
XGL6330-02	L	3	0.2	●	●	●		4.5
XGR6335-02	R	3.5	0.2	●	●	●		5.3
XGL6335-02	L	3.5	0.2	●	●	●		5.3
XGR6340-02	R	4	0.2	●	●	●		6
XGL6340-02	L	4	0.2	●	●	●		6
XGR6345-02	R	4.5	0.2	●	●	●		6
XGL6345-02	L	4.5	0.2	●	●	●		6

Use right-hand toolholders (GX-****R) with left-hand inserts (XGL...)
left-hand toolholders (GX-****L) with right-hand inserts (XGR...).

● : Line up

STANDARD CUTTING CONDITIONS

ISO	Workpiece material	Grade	Cutting speed Vc (m/min)	Feed f (mm/rev)		
				W < 2 mm	W = 2 ~ 4 mm	W > 4 mm
P	Carbon steels	NS9530	80 - 200	0.05 - 0.1	0.08 - 0.2	0.08 - 0.25
		UX30	60 - 150	0.05 - 0.1	0.08 - 0.2	0.08 - 0.25
K	Cast irons, Light alloys	TH10	60 - 150	0.05 - 0.1	0.08 - 0.2	0.08 - 0.25
H	Hardened steel	BX360	50 - 180	0.05 - 0.15	0.05 - 0.15	0.05 - 0.15

MY-T SERIES

CGWTR/L0040-FLL/R3NP

Internal grooving and turning toolholder

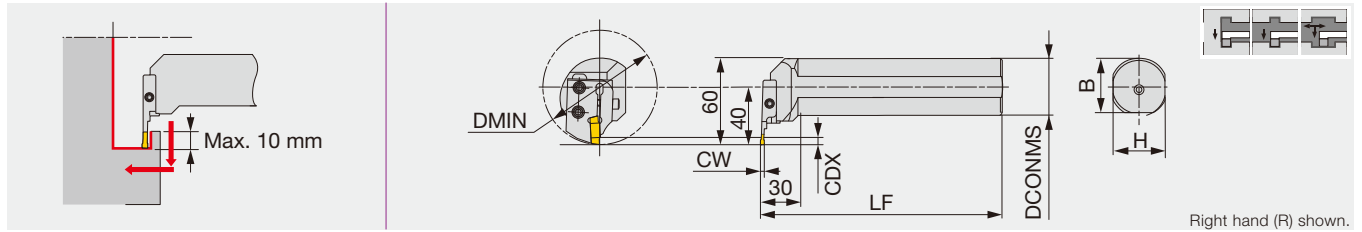

Designation	CW	DMIN	CDX	DCONMS	LF	H	B	Insert	Shank	Adapter	Torque*
CGWTR/L0040-FLL/R3NP	3	80	10	40	180	37.5	37	FLEX30L/R	CGWTR/L0040	FLL/R3NP	5

Please place an order with the designation of a set or a shank+a adapter

Note: Use right-hand shanks (CGWTR) with left-hand adapters (FLL3NP); and left-hand shanks (CGWTL) with right-hand adapters (FLR3NP).

*Torque: Recommended clamping torque (N·m)

SPARE PARTS

Designation	Clamping screw	Adapter screw	Wrench
CGWTR/L0040-FLL/R3NP	CHHM5-18	CSHB-6	P-4

INSERT

FLEX(R/L)

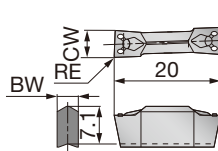

Right hand (R) shown.

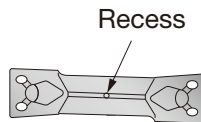

To distinguish the insert hands, the V-shape surface (top surface) of a left-hand insert has a recess. (not of a right-hand insert)

P	Steel	★			★					
M	Stainless									★
K	Cast iron				☆					
N	Non-ferrous									
S	Superalloys									
H	Hard materials									

★ : First choice
☆ : Second choice

Designation	HAND	CW±0.05	RE	Coated			Cermet			Uncoated			BW
				T9225			NS9530			UX30			
FLEX30R	R	3	0.4				●						2.2
FLEX30L	L	3	0.4				●						2.2
FLEX40R	R	4	0.4				●						3.1
FLEX40L	L	4	0.4				●						3.1
FLEX50R	R	5	0.4	●			●		●				4
FLEX50L	L	5	0.4	●			●		●				4

● : Line up

STANDARD CUTTING CONDITIONS

ISO	Workpiece material	Grade	Cutting speed Vc (m/min)	Feed: f (mm/rev)	
				Grooving	Turning
P	Carbon steels	T9225	80 - 300	0.05 - 0.25	0.1 - 0.3
		NS9530	80 - 200	0.05 - 0.25	0.1 - 0.3
		UX30	60 - 150	0.05 - 0.25	0.1 - 0.3

Face grooving and turning toolholder

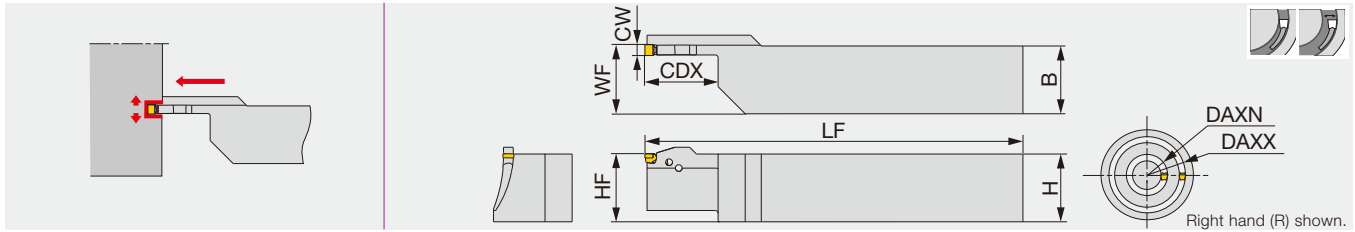

Designation	CW	DAXN	DAXX	CDX	H	B	LF	HF	WF	Insert
ETFR/L2020-4T15-030035	4	30	35	15	20	20	125	20	20.5	E**4...
ETFR/L2525-4T15-030035	4	30	35	15	25	25	150	25	25.5	E**4...
ETFR/L2020-4T22-035045	4	35	45	22	20	20	125	20	20.5	E**4...
ETFR/L2525-4T22-035045	4	35	45	22	25	25	150	25	25.5	E**4...
ETFR/L2020-4T25-045055	4	45	55	25	20	20	125	20	20.5	E**4...
ETFR/L2525-4T25-045055	4	45	55	25	25	25	150	25	25.5	E**4...
ETFR/L2020-4T25-055075	4	55	75	25	20	20	125	20	20.5	E**4...
ETFR/L2525-4T25-055075	4	55	75	25	25	25	150	25	25.5	E**4...
ETFR/L2020-4T25-075120	4	75	120	25	20	20	125	20	20.5	E**4...
ETFR/L2525-4T25-075120	4	75	120	25	25	25	150	25	25.5	E**4...
ETFR/L2525-4T25-120200	4	120	200	25	25	25	150	25	25.5	E**4...
ETFR/L2525-4T25-200500	4	200	500	25	25	25	150	25	25.5	E**4...
ETFR/L2525-5T25-035045	5	35	45	25	25	25	150	25	25.5	ETX5...
ETFR/L2525-5T25-045055	5	45	55	25	25	25	150	25	25.5	ETX5...
ETFR/L2525-5T25-055075	5	55	75	25	25	25	150	25	25.5	ETX5...
ETFR/L2525-5T32-075120	5	75	120	32	25	25	150	25	25.5	ETX5...
ETFR/L2525-5T32-120200	5	120	200	32	25	25	150	25	25.5	ETX5...
ETFR/L2525-5T32-200500	5	200	500	32	25	25	150	25	25.5	ETX5...
ETFR/L2525-6T25-040055	6	40	55	25	25	25	150	25	25.5	ETX6...
ETFR/L2525-6T25-055075	6	55	75	25	25	25	150	25	25.5	ETX6...
ETFR/L2525-6T32-075120	6	75	120	32	25	25	150	25	25.5	ETX6...
ETFR/L2525-6T32-120200	6	120	200	32	25	25	150	25	25.5	ETX6...
ETFR/L2525-6T32-200500	6	200	500	32	25	25	150	25	25.5	ETX6...

Wrench (ECW...) is not included. Please order it separately.

ETFR-CHP

Tube connection

Face grooving and turning toolholder, with high pressure coolant capability

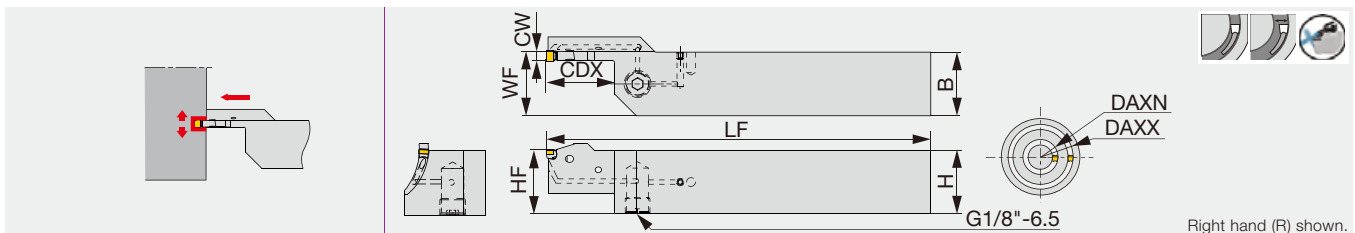

Designation	CW	DAXN	DAXX	CDX	H	B	LF	HF	WF	Insert
ETFR2525-4T15-030035-CHP	4	30	35	15	25	25	150	25	25.5	E**4...
ETFR2525-4T22-035045-CHP	4	35	45	22	25	25	150	25	25.5	E**4...
ETFR2525-4T25-045055-CHP	4	45	55	25	25	25	150	25	25.5	E**4...
ETFR2525-4T25-055075-CHP	4	55	75	25	25	25	150	25	25.5	E**4...
ETFR2525-4T25-075120-CHP	4	75	120	25	25	25	150	25	25.5	E**4...
ETFR2525-4T25-120200-CHP	4	120	200	25	25	25	150	25	25.5	E**4...
ETFR2525-4T25-200500-CHP	4	200	500	25	25	25	150	25	25.5	E**4...

Wrench (ECW...) is not included. Please order it separately.

SPARE PARTS

Designation	Wrench (Optional)
ETFR/L...	ECW-456EF

Reference pages: Inserts → **F170, F171**, Standard cutting conditions → **F171**
 Parts for coolant hose → **F266**

EFPR/L

Face grooving blade

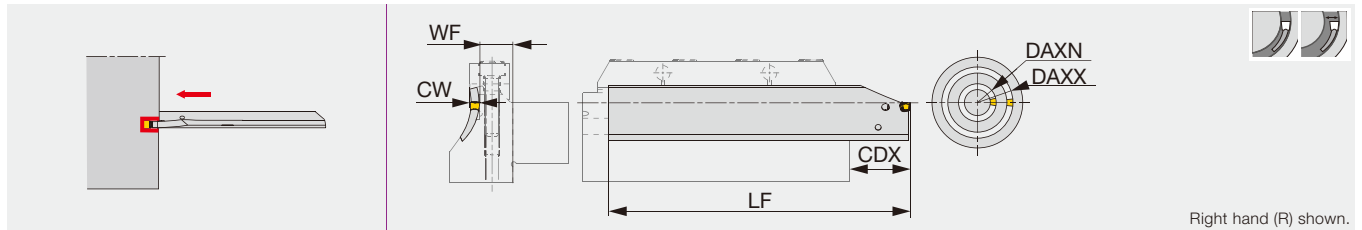

Designation	CW	DAXN	DAXX	WF	LF	Min. CDX	Max. CDX	Insert
EFPR/L-4-030035	4	30	35	13.6	125	18	50	E**4...
EFPR-4-035045	4	35	45	13.6	125	18	50	E**4...
EFPR-4-045055	4	45	55	13.6	125	18	50	E**4...
EFPR-4-055075	4	55	75	13.6	125	18	50	E**4...
EFPR-4-075120	4	75	120	13.6	140	18	65	E**4...
EFPR-4-120200	4	120	200	13.6	140	18	65	E**4...
EFPR-4-200500	4	200	500	13.6	140	18	65	E**4...
EFPR-5-035045	5	35	45	13.6	125	19	50	ETX5...
EFPR-5-045055	5	45	55	13.6	125	19	50	ETX5...
EFPR-5-055075	5	55	75	13.6	125	19	50	ETX5...
EFPR-5-075120	5	75	120	13.6	140	19	65	ETX5...
EFPR-5-120200	5	120	200	13.6	140	19	65	ETX5...
EFPR-5-200500	5	200	500	13.6	140	19	65	ETX5...
EFPR-6-045055	6	45	55	13.6	125	20	50	ETX6...
EFPR-6-055075	6	55	75	13.6	125	20	50	ETX6...
EFPR-6-075120	6	75	120	13.6	140	20	65	ETX6...
EFPR-6-120200	6	120	200	13.6	140	20	65	ETX6...
EFPR/L-6-200500	6	200	500	13.6	140	20	65	ETX6...

Wrench (ECW...) is not included. Please order it separately.

SPARE PARTS

Designation	Wrench (Optional)
EFPR/L...	ECW-456I

CTBU-CHP for EFPR/L

Tool block for EFP blades with high pressure coolant capability

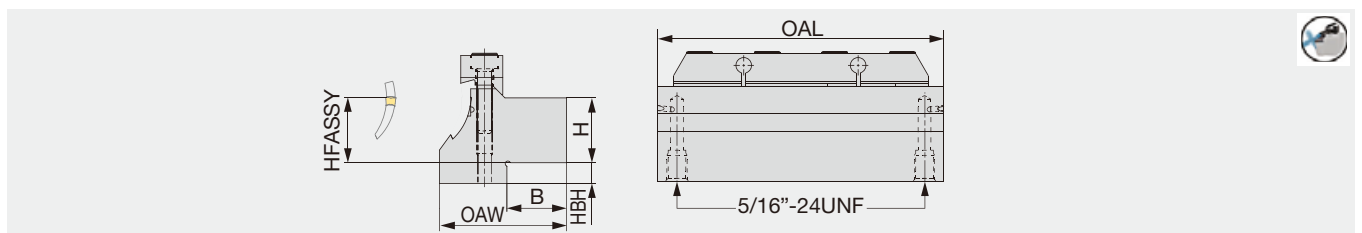

Designation	CW	DAXN	H	B	HFASSY	HBH	OAW	OAL	Blade
CTBU25-030-4-CHP	4	30	25	23	25	8	49	110	EFPR/L-4-030035
CTBU25-035-4/5-CHP	4, 5	35	25	23	25	8	49	110	EFPR-4/5-035045
CTBU25-045-4/5-CHP	4, 5	45	25	23	25	8	49	110	EFPR-4/5-045055
CTBU25-055-4/5-CHP	4, 5	55	25	23	25	8	47	110	EFPR-4/5-055075
CTBU25-075-4/5-CHP	4, 5	75	25	23	25	8	45	110	EFPR-4/5-075120
CTBU25-120-4/5-CHP	4, 5	120	25	23	25	8	44	110	EFPR-4/5-120200
CTBU25-200-4/5-CHP	4, 5	200	25	23	25	8	41.5	110	EFPR-4/5-200500
CTBU25-045-6-CHP	6	45	25	23	25	8	51	110	EFPR-6-045055
CTBU25-055-6-CHP	6	55	25	23	25	8	49	110	EFPR-6-055075
CTBU25-075-6-CHP	6	75	25	23	25	8	47	110	EFPR-6-075120
CTBU25-120-6-CHP	6	120	25	23	25	8	46	110	EFPR-6-120200
CTBU25-200-6-CHP	6	200	25	23	25	8	43.5	110	EFPR/L-6-200500

SPARE PARTS

Designation	Clamp	Clamping screw	Wrench
CTBU25-***-***-CHP	CT-110	CM6X30-S	P-5

Reference pages: Inserts → **F170, F171**

Standard cutting conditions → **F171**

Parts for coolant hose → **F266**



CHIPBREAKER GUIDE

ETX type



Multi-functional insert
Grooving and turning suitable for light to medium cutting
Well-balanced sharpness and strength
CW = 4 - 6 mm



■ Standard feed

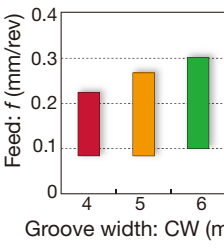

Groove width: CW (mm)	Standard feed: f (mm/rev)
4	0.22
5	0.27
6	0.30

■ Standard feed and depth of cut for turning

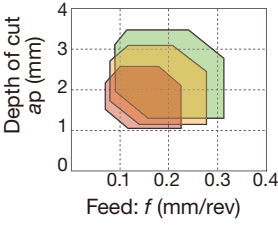

Depth of cut a_p (mm)

Feed: f (mm/rev)

EGM type



1st choice for parting
High strength
Well-designed edge
CW = 4 mm



■ Standard feed

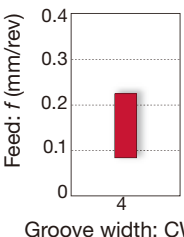

Groove width: CW (mm)	Standard feed: f (mm/rev)
4	0.22

- External
- Internal
- Face
- Parting
- Others

INSERTS

ETX

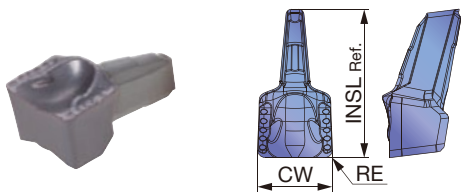

P	Steel	★							
M	Stainless	★							
K	Cast iron	☆							
N	Non-ferrous								
S	Superalloys								
H	Hard materials								

★ : First choice
☆ : Second choice

Designation	CW±0.05	RE	Coated							INSL
			AH725							
ETX4-040	4	0.4	●							8
ETX5-040	5	0.4	●							10
ETX6-040	6	0.4	●							12

● : Line up

Reference pages: Toolholders → **F168, F169**

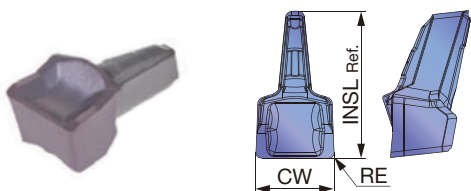

P	Steel	★							
M	Stainless	★							
K	Cast iron	☆							
N	Non-ferrous								
S	Superalloys								
H	Hard materials								

★ : First choice
☆ : Second choice

Designation	CW±0.05	RE	Coated							INSL
			AH725							
EGM4-030	4	0.3	●							8

● : Line up

STANDARD CUTTING CONDITIONS

ISO	Workpiece material	Hardness	Grade	Chipbreaker	Cutting speed Vc (m/min)
P	Low carbon steel S45C, etc. S15C, etc.	- 300 HB	AH725	ETX	80 - 180
		- 300 HB	AH725	EGM	80 - 180
	Carbon steel, Alloy steel S55C, etc. SCM440, etc.	- 300 HB	AH725	ETX	80 - 180
		- 300 HB	AH725	EGM	80 - 180
		- 300 HB	AH725	ETX	80 - 180
Prehardened steel NAK80, etc. PX5, etc.	- 300 HB	AH725	ETX	80 - 180	
	- 300 HB	AH725	EGM	80 - 180	
M	Stainless steels SUS303, etc. SUS316, etc.	-	AH725	ETX	50 - 120
		-	AH725	EGM	50 - 120

Procedure to clamp and unclamp insert

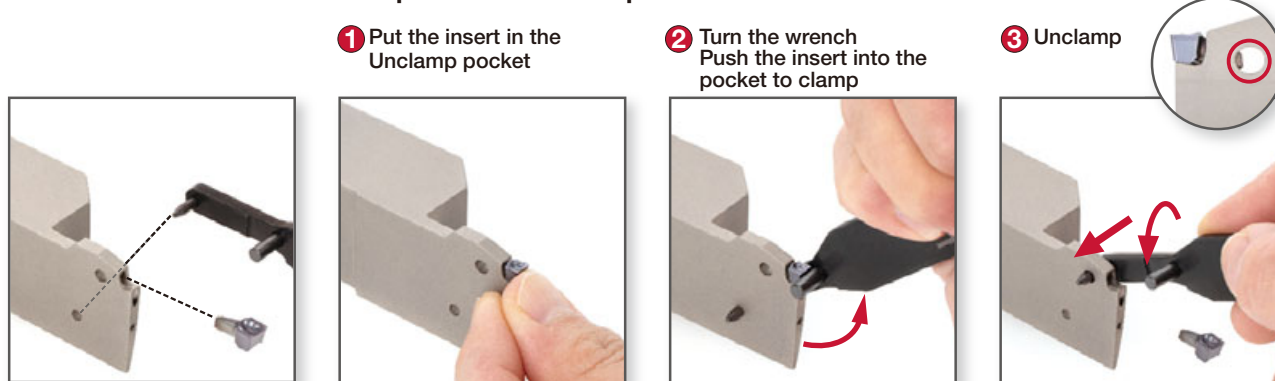

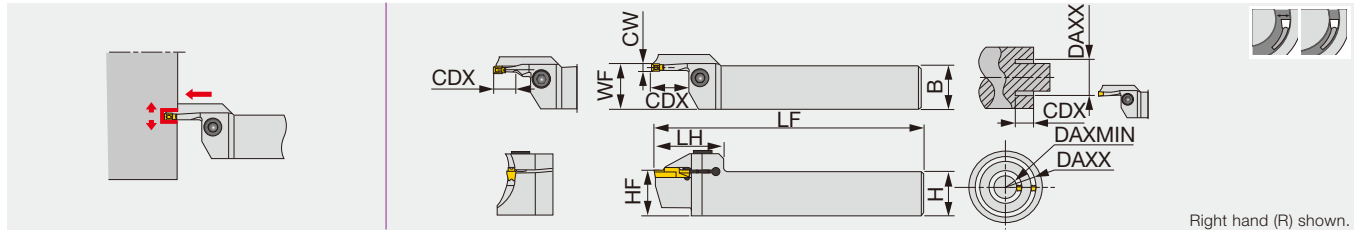

Designation	CW	DAXMIN	DAXX	Seat size	CDX	H	B	LF	LH	HF	WF ⁽¹⁾	Torque*
CTFR/L2525-3T10-024035	3	24	35	3	10	25	25	150	38	25	25.5	5
CTFR/L2525-3T10-029040	3	29	40	3	10	25	25	150	38	25	25.5	5
CTFR/L2525-3T10-034050	3	34	50	3	10	25	25	150	38	25	25.5	5
CTFR/L2525-3T15-044070	3	44	70	3	15	25	25	150	38	25	25.5	5
CTFR/L2525-3T15-064100	3	64	100	3	15	25	25	150	38	25	25.5	5
CTFR/L2525-4T10-022036	4	22	36	4	10	25	25	150	39	25	25.6	5
CTFR/L2525-4T20-028042	4	28	42	4	20	25	25	150	39	25	25.6	5
CTFR/L2525-4T20-034050	4	34	50	4	20	25	25	150	39	25	25.6	5
CTFR/L2525-4T20-042070	4	42	70	4	20	25	25	150	39	25	25.6	5
CTFR/L2525-4T20-062120	4	62	120	4	20	25	25	150	39	25	25.6	5
CTFR/L2525-4T20-112200	4	112	200	4	20	25	25	150	39	25	25.6	5
CTFR/L2525-5T25-050080	5	50	80	5	25	25	25	150	49	25	25.6	12
CTFR/L2525-5T25-070110	5	70	110	5	25	25	25	150	49	25	25.6	12
CTFR/L2525-5T25-100150	5	100	150	5	25	25	25	150	49	25	25.6	12
CTFR/L2525-5T25-140200	5	140	200	5	25	25	25	150	49	25	25.6	12
CTFR/L2525-6T25-048070	6	48	70	6	25	25	25	150	49	25	25.6	12
CTFR/L2525-6T25-058100	6	58	100	6	25	25	25	150	49	25	25.6	12
CTFR/L2525-6T25-088180	6	88	180	6	25	25	25	150	49	25	25.6	12
CTFR/L2525-6T25-168400	6	168	400	6	25	25	25	150	49	25	25.6	12

When depth is deeper than (insert length - 1.5 mm), 1 corner type is recommended.
 Max. groove depth will be 15 mm with DTF insert.
 Use the right-hand insert for the right-hand holder with DTF insert.
 (1) WF is calculated with the groove width (CW) in the above table.
 Torque*: Recommended clamping torque (N·m)

SPARE PARTS

Designation	Clamping screw	Wrench
CTFR/L2525-3T - 4T...	CM6X1X25-A	P-5
CTFR/L2525-5T - 6T...	CM8X1.25X25-A	P-6

INSERT

Designation	Seat size	Insert
CTFR/L2525-3T10-024035	3	DTF, DTX
CTFR/L2525-3T10-029040	3	DTF, DTX
CTFR/L2525-3T10-034050	3	DTF, DTX
CTFR/L2525-3T15-044070	3	DTF, DTX, DTR, DTE, DGG, DTM
CTFR/L2525-3T15-064100	3	DTF, DTX, DTE, DGG, DGM, DGS, DTR, SGN, DGL, DTM
CTFR/L2525-4T10-022036	4	DTF, DTX
CTFR/L2525-4T20-028042	4	DTF, DTX, DTR
CTFR/L2525-4T20-034050	4	DTF, DTX, DTE, DGG, DGM, DGS, DTR, DTM, DGL, SGN
CTFR/L2525-4T20-042070	4	DTF, DTX, DTE, DGG, DGM, DGS, DTR, SGN, DTM, DGL
CTFR/L2525-4T20-062120	4	DTF, DTX, DTE, DGG, DGM, DGS, DTR, SGN, DTM, DGL
CTFR/L2525-4T20-112200	4	DTF, DTX, DTE, DGG, DGM, DGS, DTR, SGN, DTM, DGL
CTFR/L2525-5T25-...	5	DTX, DTE, DGG, DGM, DGS, DTR, DTM, DGL, SGN
CTFR/L2525-6T25-...	6	DTX, DTE, DGG, DGM, DGS, DTR, DTM, DGL, SGN

Insert	Groove width CW	Face grooving Min. machining dia. DAXMIN
DGM / DGS / SGN / DGL	3	92
DGM / DGS / SGN / DGL	4	37
DGM / DGS / SGN / DGL	5	60
DGM / DGS / DGL	6	57
DTE / DGG / DTM	3	62
DTE / DGG / DTM	4	42
DTE / DGG / DTM	5	64
DTE / DGG / DTM	6	61
DTR	3	44
DTR	4	32
DTR	5	48
DTR	6	48
DTX	3	22
DTX	4	20
DTX	5	20
DTX	6	23
DTF	3	20
DTF	4	20

Reference pages: Inserts → **F183 - F197**, Standard cutting conditions → **F198**

CTFVR/L

Face grooving and turning perpendicular toolholder

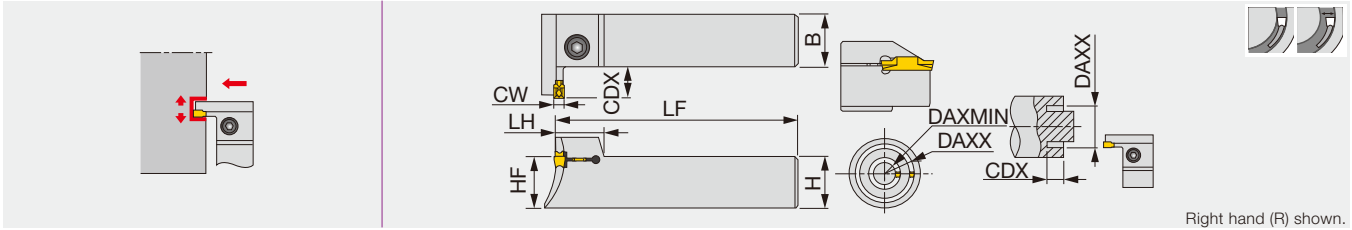

Designation	CW	DAXMIN	DAXX	Seat size	CDX	H	B	LF	LH	HF	Torque*
CTFVR/L2525-3T10-024035	3	24	35	3	10	25	25	150	18	25	5
CTFVR/L2525-3T10-029040	3	29	40	3	10	25	25	150	18	25	5
CTFVR/L2525-3T10-034050	3	34	50	3	10	25	25	150	18	25	5
CTFVR/L2525-3T15-044060	3	44	60	3	15	25	25	150	18	25	5
CTFVR/L2525-3T15-054085	3	54	85	3	15	25	25	150	18	25	5
CTFVR/L2525-4T12-022040	4	22	40	4	12	25	25	150	18.5	25	8.5
CTFVR/L2525-4T15-032050	4	32	50	4	15	25	25	150	18.5	25	8.5
CTFVR/L2525-4T15-042060	4	42	60	4	15	25	25	150	18.5	25	8.5
CTFVR/L2525-4T15-052085	4	52	85	4	15	25	25	150	18.5	25	8.5
CTFVR/L2525-5T20-050080	5	50	80	5	20	25	25	150	22	25	12
CTFVR/L2525-5T20-070110	5	70	110	5	20	25	25	150	22	25	12
CTFVR/L2525-5T20-100150	5	100	150	5	20	25	25	150	22	25	12
CTFVR/L2525-5T20-140200	5	140	200	5	20	25	25	150	22	25	12
CTFVR/L2525-6T20-048085	6	48	85	6	20	25	25	150	22	25	12
CTFVR/L2525-6T20-073150	6	73	150	6	20	25	25	150	22	25	12
CTFVR/L2525-6T20-138250	6	138	250	6	20	25	25	150	22	25	12

When depth is deeper than (insert length - 1.5 mm), 1 corner type is recommended
 Max. groove depth will be 15 mm with DTF insert.
 Use the right-hand insert for the right-hand holder with DTF insert.
 Torque*: Recommended clamping torque (N·m)

SPARE PARTS

Designation	Clamping screw	Wrench
CTFVR/L2525-3T...	CM5X0.8X25-A	P-4
CTFVR/L2525-4T...	CM6X1X25-A	P-5
CTFVR/L2525-5T..., 6T...	CM8X1.25X25-A	P-6

INSERT

Designation	Seat size	Insert
CTFVR/L2525-3T10-024035	3	DTF, DTX
CTFVR/L2525-3T10-029040	3	DTF, DTX
CTFVR/L2525-3T10-034050	3	DTF, DTX, DTR
CTFVR/L2525-3T15-044060	3	DTF, DTX, DTR
CTFVR/L2525-3T15-054085	3	DTF, DTX, DTE, DGG, DTR, DTM
CTFVR/L2525-4T12-022040	4	DTF, DTX, DTR
CTFVR/L2525-4T15-032050	4	DTF, DTX, DTE, DGG, DGM, DGS, DTR, DTM, DGL, SGN
CTFVR/L2525-4T15-042060	4	DTF, DTX, DTE, DGG, DGM, DGS, DTR, SGN, DTM, DGL
CTFVR/L2525-4T15-052085	4	DTF, DTX, DTE, DGG, DGM, DGS, DTR, SGN, DTM, DGL
CTFVR/L2525-5T20-...	5	DTX, DTE, DGG, DGM, DGS, DTR, DTM, DGL, SGN
CTFVR/L2525-6T20-...	6	DTX, DTE, DGG, DGM, DGS, DTR, DTM, DGL

Insert	Groove width CW	Face grooving Min. machining dia. DAXMIN
DGM / DGS / SGN / DGL	3	92
DGM / DGS / SGN / DGL	4	37
DGM / DGS / SGN / DGL	5	60
DGM / DGS / DGL	6	57
DTE / DGG / DTM	3	62
DTE / DGG / DTM	4	42
DTE / DGG / DTM	5	64
DTE / DGG / DTM	6	61
DTR	3	44
DTR	4	32
DTR	5	48
DTR	6	48
DTX	3	22
DTX	4	20
DTX	5	20
DTX	6	23
DTF	3	20
DTF	4	20

Reference pages: Inserts → **F183 - F197**, Standard cutting conditions → **F198**



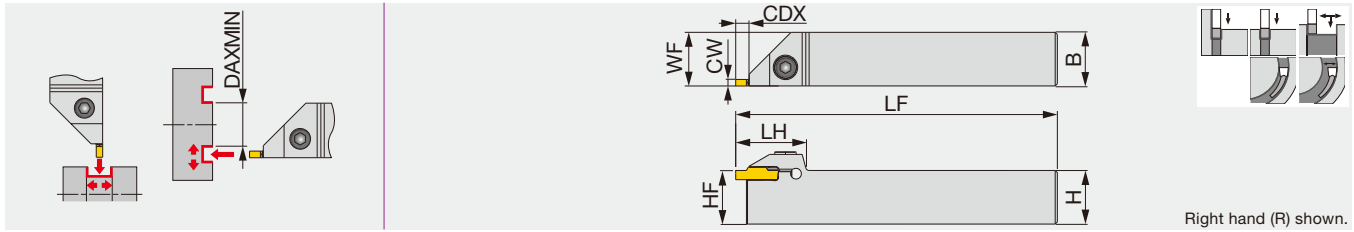

Designation	CW	Seat size	CDX	H	B	LF	LH	HF	WF ⁽¹⁾	Torque*
CTEFR/L2020-4T04	4	2, 3, 4	4.8	20	20	125	33	20	20.5	8.5
CTEFR/L2525-4T04	4	2, 3, 4	4.8	25	25	150	33	25	25.5	8.5
CTEFR/L2020-6T04	6	5, 6	4.8	20	20	125	37	20	20.6	8.5
CTEFR/L2525-6T04	6	5, 6	4.8	25	25	150	37	25	25.6	8.5

(1) "WF" value is calculated with groove width "CW" shown in the table.
Torque*: Recommended clamping torque (N·m)

SPARE PARTS

Designation	Clamping screw	Wrench
CTEFR/L2020-4T04	CM6X1X20-A	P-5
CTEFR/L2525-4T04	CM6X1X25-A	P-5
CTEFR/L2020-6T04	CM6X1X20-A	P-5
CTEFR/L2525-6T04	CM6X1X25-A	P-5

Insert	Groove width CW	Face grooving Min. machining dia. DAXMIN
DGM / DGS / SGN / DGL	2	295
DGM / DGS / SGN / DGL	3	92
DGM / DGS / SGN / DGL	4	37
DGM / DGS / SGN / DGL	5	60
DGM / DGS / DGL	6	57
DTX / DTM / DTR	2	295
DTE / DGG / DTM	3	62
DTE / DGG / DTM	4	42
DTE / DGG / DTM	5	64
DTE / DGG / DTM	6	61

Insert	Groove width CW	Face grooving Min. machining dia. DAXMIN
DTR	3	44
DTR	4	32
DTR	5	48
DTR	6	48
DTX	3	22
DTX	4	20
DTX	5	20
DTX	6	23
DTF	3	20
DTF	4	20

CAEFR/L-CHP

Face and external grooving adapter, with high pressure coolant capability

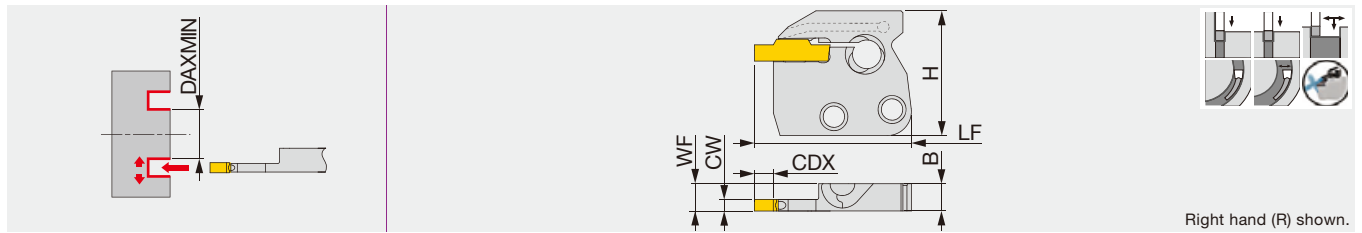

Designation	CW	Seat size	CDX	H	B	LF	WF (1)
CAEFR/L-4T04-CHP	4	2,3,4	4.8	33	7.2	41.5	7.7
CAEFR/L-6T04-CHP	6	5,6	4.8	33	7.2	46.3	7.8

(1) "WF" value is calculated with groove width "CW" shown in the table.

CAFR/L-CHP

Face grooving and turning adapter, with high pressure coolant capability

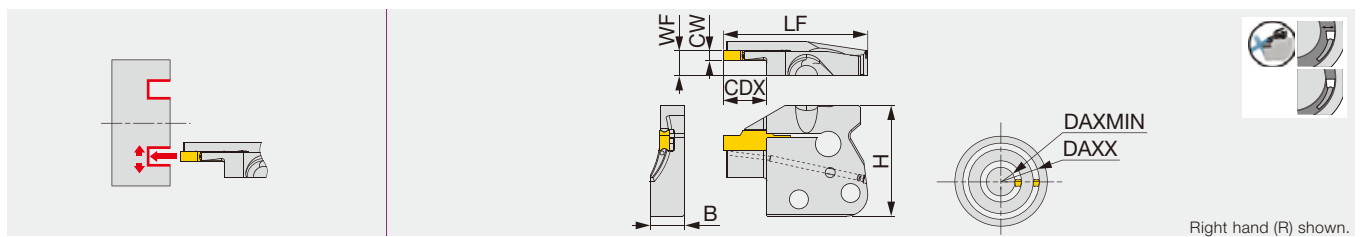

Designation	CW	DAXMIN	DAXX	Seat size	CDX	H	B	LF	WF (1)
CAFR/L-3T12-040055-CHP	3	40	55	3	12	33	10.2	43	7.5
CAFR/L-3T12-055075-CHP	3	55	75	3	12	33	10.2	43	7.5
CAFR/L-3T12-075100-CHP	3	75	100	3	12	33	10.2	43	7.5
CAFR/L-3T12-100140-CHP	3	100	140	3	12	33	10.2	43	7.5
CAFR/L-3T12-140200-CHP	3	140	200	3	12	33	10.2	43	7.5
CAFR/L-4T16-050070-CHP	4	50	70	4	16	33	10.2	43	8
CAFR/L-4T16-070100-CHP	4	70	100	4	16	33	10.2	43	8
CAFR/L-4T16-100150-CHP	4	100	150	4	16	33	10.2	43	8
CAFR/L-4T16-150250-CHP	4	150	250	4	16	33	10.2	43	8
CAFR/L-5T20-055080-CHP	5	55	80	5	20	33	10.2	47	8.5
CAFR/L-5T20-080120-CHP	5	80	120	5	20	33	10.2	47	8.5
CAFR/L-5T20-120180-CHP	5	120	180	5	20	33	10.2	47	8.5
CAFR/L-5T20-180300-CHP	5	180	300	5	20	33	10.2	47	8.5
CAFR/L-5T20-300000-CHP	5	300	∞	5	20	33	10.2	47	8.5
CAFR/L-6T25-060090-CHP	6	60	90	6	25	33	10.2	52	9
CAFR/L-6T25-090150-CHP	6	90	150	6	25	33	10.2	52	9
CAFR/L-6T25-150250-CHP	6	150	250	6	25	33	10.2	52	9
CAFR/L-6T25-250400-CHP	6	250	400	6	25	33	10.2	52	9

When groove depth is larger than (insert length - 1.5 mm), please use 1-cornered insert.
Max. groove depth will be 15 mm with DTF insert.
Use the right-hand insert for the right-hand holder with DTF insert.
(1) WF is calculated with the groove width (CW) in the above table.

Insert	Groove width CW	Face grooving Min. machining dia. DAXMIN
DGM / DGS / SGN / DGL	2	295
DGM / DGS / SGN / DGL	3	92
DGM / DGS / SGN / DGL	4	37
DGM / DGS / SGN / DGL	5	60
DGM / DGS / DGL	6	57
DTX / DTM / DTR	2	295
DTE / DGG / DTM	3	62
DTE / DGG / DTM	4	42
DTE / DGG / DTM	5	64
DTE / DGG / DTM	6	61

Insert	Groove width CW	Face grooving Min. machining dia. DAXMIN
DTR	3	44
DTR	4	32
DTR	5	48
DTR	6	48
DTX	3	22
DTX	4	20
DTX	5	20
DTX	6	23
DTF	3	20
DTF	4	20

Reference pages: Inserts → **F183 - F197**, Shanks and toolholders → **F176 - F178**
Standard cutting conditions → **F198**, Technical Reference → **L053**

Shank for adapter, with high pressure coolant capability

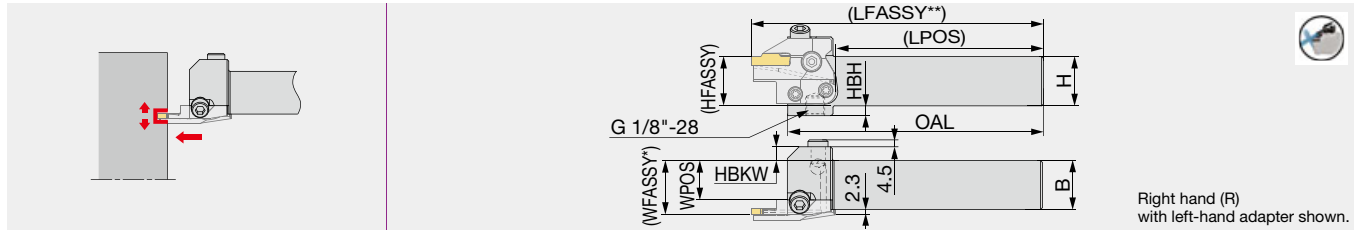

Right hand (R)
with left-hand adapter shown.

Designation	H	B	OAL	LPOS	WPOS	HBKW	HFASSY	HBH	Adapter (Option)	Torque*
CHSR/L2020-CHP	20	20	130	105.5	15.1	12	20	10	CA*FL/R**-CHP	6.5
CHSR/L2525-CHP	25	25	130	105.5	20.1	7	25	5	CA*FL/R**-CHP	6.5

WFASSY* : Shank (WPOS) + adapter (WF)
 LFASSY** : Shank (LPOS) + adapter (LF)
 Depend on the adapter type, the value of LFASSY or WFASSY may change.
 Torque*: Recommended clamping torque (N·m)
 Applicable for 30 MPa coolant
 Please see page L053 for instructions on installing and removing the adapter or the insert.

- External
- Internal
- Face
- Parting
- Others

CHSR/L-CHP-MC

Direct connection

Shank for adapter, with high pressure coolant capability

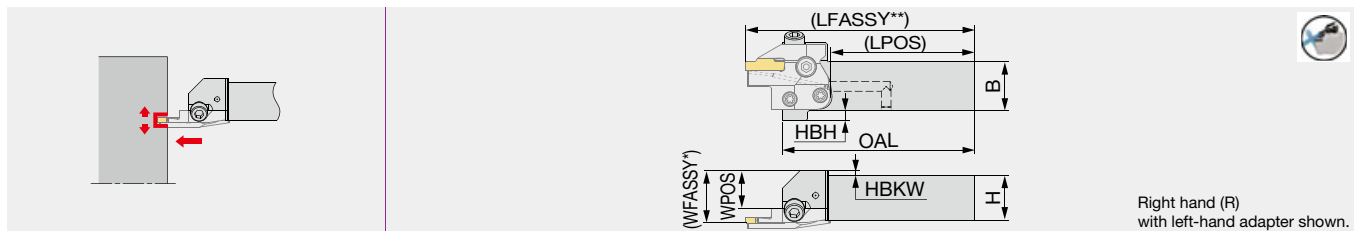

Right hand (R)
with left-hand adapter shown.

Designation	H	B	OAL	LPOS	WPOS	HBKW	HBH	Adapter (Option)	Torque*
CHSR/L2020-CHP-MC	20	20	98	73.5	14	6	10	CA*FL/R**-CHP	6.5
CHSR/L2525-CHP-MC	25	25	98	73.5	19	-	5	CA*FL/R**-CHP	6.5

WFASSY* : Shank (WPOS) + adapter (WF)
 LFASSY** : Shank (LPOS) + adapter (LF)
 Depend on the adapter type, the value of LFASSY or WFASSY may change.
 Torque*: Recommended clamping torque (N·m)
 Applicable for 30 MPa coolant
 Please see page L053 for instructions on installing and removing the adapter or the insert.

SPARE PARTS

Designation	Clamping screw 1	Wrench 1	Clamping screw 2	Clamping screw 3	Wrench 2	O-ring	Plug
CHSR/L**-CHP	SR M5-04451	T-20/5	SR M6X12DIN6912	SR M6X20-XT	HW5.0	OR 5X1N	PLUGG1/8ISO1179
CHSR/L**-CHP-MC	SR M5-04451	T-20/5	SR M6X12DIN6912	SR M6X20-XT	HW5.0	OR 5X1N	-

Recommended clamping torque (N·m)

Clamping screw	Torque (N·m)
SR M5-04451	2.5
SR M6X12DIN6912	6.5
SR M6X20-XT	6.5

Combination of adapter and shank

Shank	External grooving adapter		Face grooving adapter		External and face grooving adapter	
	CAER**-CHP, -MD	CAEL**-CHP, -MD	CAFR**-CHP	CAFL**-CHP	CAEFR**-CHP	CAEFL**-CHP
CHSR**-CHP (-MC)	●			●	●	
CHSL**-CHP (-MC)		●	●			●

● : Corresponding

Reference pages: Inserts → F183 - F197, Adapters → F175, Standard cutting conditions → F198
 Parts for coolant hose → F266, Technical Reference → L053

CHFVR/L-CHP

Tube connection

Shank for perpendicularly-mounted adapter, with high pressure coolant capability

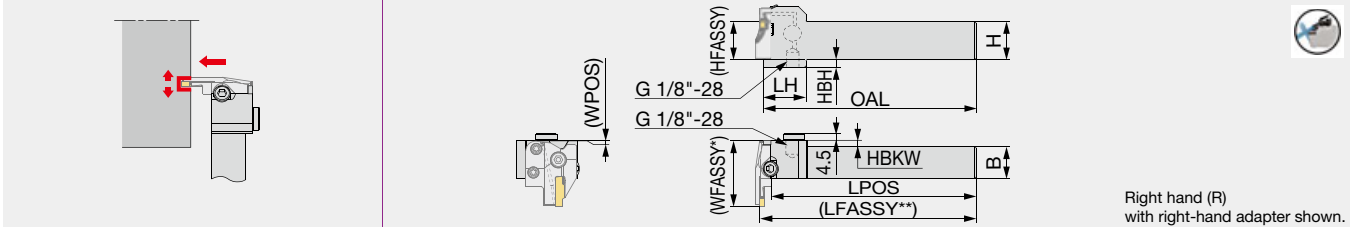

Right hand (R)
with right-hand adapter shown.

Designation	H	B	OAL	LH	LPOS	WPOS	HBKW	HFASSY	HBH	Adapter (Option)	Torque*
CHFVR/L2020-CHP	20	20	140	28	135.1	0.5	5	20	10	CA*FR/L**-CHP	6.5
CHFVR/L2525-CHP	25	25	140	28	135.1	0.5	0	25	5	CA*FR/L**-CHP	6.5

WFASSY* : Shank (WPOS) + adapter (LF)

LFASSY** : Shank (LPOS) + adapter (WF)

Depend on the adapter type, the value of LFASSY or WFASSY may change.

Torque*: Recommended clamping torque (N·m)

Applicable for 30 MPa coolant

Please see page L053 for instructions on installing and removing the adapter or the insert.

SPARE PARTS

Designation	Clamping screw 1	Wrench 1	Clamping screw 2	Clamping screw 3	Wrench 2	O-ring	Plug
CHFVR/L...	SR M5-04451	T-20/5	SR M6X12DIN6912	SR M6X20-XT	HW5.0	OR 5X1N	PLUGG1/8ISO1179

Recommended clamping torque (N·m)

Clamping screw	Torque (N·m)
SR M5-04451	2.5
SR M6X12DIN6912	6.5
SR M6X20-XT	6.5

Combination of adapter and shank

Shank	External grooving adapter		Face grooving adapter		External and face grooving adapter	
	CAER**-CHP, -MD	CAEL**-CHP, -MD	CAFR**-CHP	CAFL**-CHP	CAEFR**-CHP	CAEFL**-CHP
CHFVR**-CHP		●	●			●
CHFVL**-CHP	●			●	●	

● : Corresponding

Reference pages: Inserts → F183 - F197, Adapters → F175, Standard cutting conditions → F198
Parts for coolant hose → F266, Technical Reference → L053

Grade
Insert
Ext. Toolholder
Int. Toolholder
Threading
Grooving
Miniature tool
Milling cutter
Endmill
Drilling tool
Tooling System
User's Guide
Index

A
B
C
D
E
F
G
H
I
J
K
L
M

Toolholder with TungCap connection, for adapter, with high pressure coolant capability

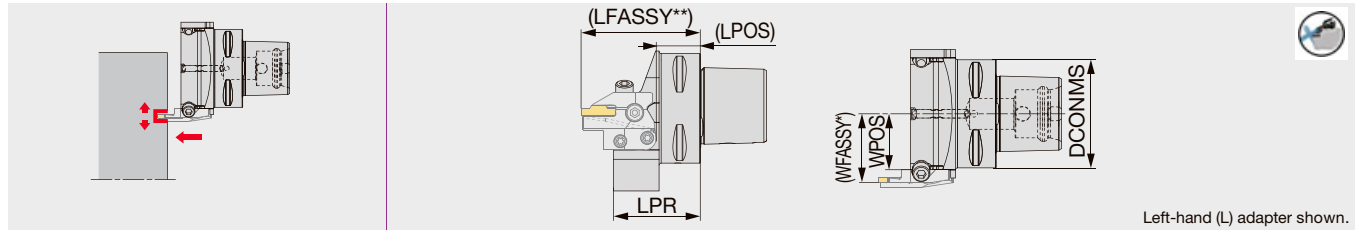

Left-hand (L) adapter shown.

Designation	DCONMS	LPR	LPOSS	WPOSS	Adapter (Option)	Torque*
C3CHSN19045-CHP	32	45	17.5	18.5	CA*FR/L**-CHP	6.5
C4CHSN21047-CHP	40	46.5	21.5	21	CA*FR/L**-CHP	6.5
C5CHSN26047-CHP	50	47	22.5	26	CA*FR/L**-CHP	6.5
C6CHSN33050-CHP	63	50	24.5	32.5	CA*FR/L**-CHP	6.5

WFASSY* : Toolholder (WPOSS) + adapter (WF)
 LFASSY** : Toolholder (LPOSS) + adapter (LF)
 Depend on the adapter type, the value of LFASSY or WFASSY may change.
 Torque*: Recommended clamping torque (N·m)
 Applicable for 30 MPa coolant
 Please see page L053 for instructions on installing and removing the adapter or the insert.

- External
- Internal
- Face
- Parting
- Others

C*CHFVN-CHP

Toolholder with TungCap connection, for perpendicularly-mounted adapter, with high pressure coolant capability

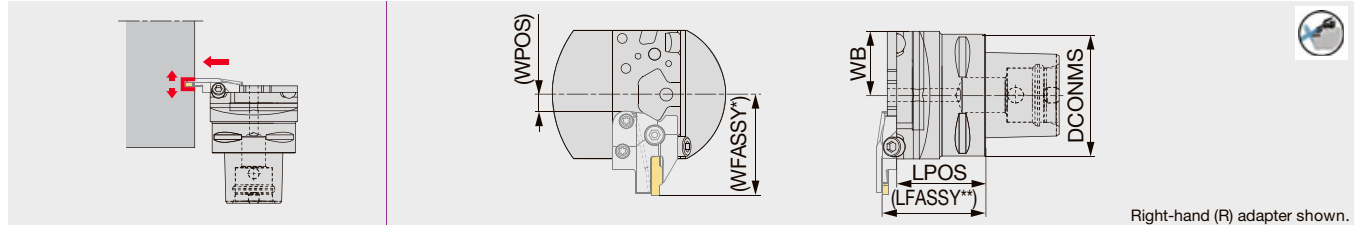

Right-hand (R) adapter shown.

Designation	DCONMS	LPOSS	WB	WPOSS	Adapter (Option)	Torque*
C3CHFVN26040-CHP	32	40	26	1.5	CA*FR/L**-CHP	6.5
C4CHFVN26046-CHP	40	46	26	1.5	CA*FR/L**-CHP	6.5
C5CHFVN26046-CHP	50	46	26	1.5	CA*FR/L**-CHP	6.5
C6CHFVN33046-CHP	63	46	33	8.5	CA*FR/L**-CHP	6.5

WFASSY* : Toolholder (WPOSS) + adapter (LF)
 LFASSY** : Toolholder (LPOSS) + adapter (WF)
 Depend on the adapter type, the value of LFASSY or WFASSY may change.
 Torque*: Recommended clamping torque (N·m)
 Applicable for 30 MPa coolant
 Please see page L053 for instructions on installing and removing the adapter or the insert.

SPARE PARTS

Designation	Clamping screw 1	Wrench 1	Clamping screw 2	Clamping screw 3	Wrench 2	O-ring
C*CH**N**-CHP	SR M5-04451	T-20/5	SR M6X12DIN6912	SR M6X20-XT	HW5.0	OR 5X1N

Recommended clamping torque (N·m)

Clamping screw	Torque (N·m)
SR M5-04451	2.5
SR M6X12DIN6912	6.5
SR M6X20-XT	6.5

CAFR/L

Face grooving and turning adapter

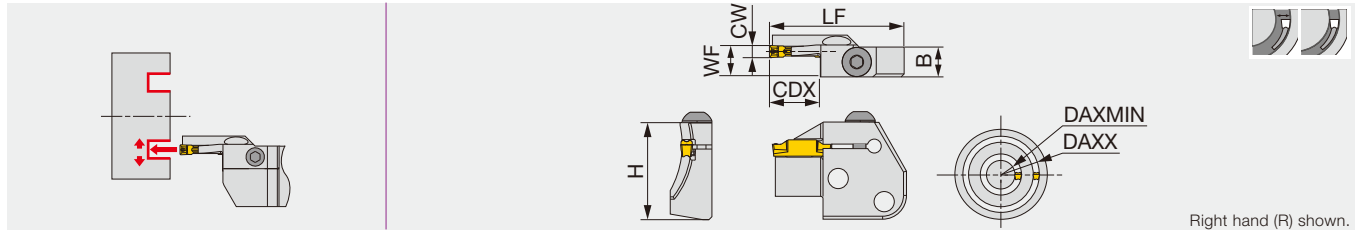

Designation	CW	DAXMIN	DAXX	Seat size	CDX	H	B	LF	WF ⁽¹⁾	Torque*
CAFR/L-3T12-040055	3	40	55	3	12	32.7	10	45	10.4	5
CAFR/L-3T12-055075	3	55	75	3	12	32.7	10	45	10.4	5
CAFR/L-3T12-075100	3	75	100	3	12	32.7	10	45	10.4	5
CAFR/L-3T12-100140	3	100	140	3	12	32.7	10	45	10.4	5
CAFR/L-3T12-140200	3	140	200	3	12	32.7	10	45	10.4	5
CAFR/L-4T16-050070	4	50	70	4	16	32.7	10	45	10.5	5
CAFR/L-4T16-070100	4	70	100	4	16	32.7	10	45	10.5	5
CAFR/L-4T16-100150	4	100	150	4	16	32.7	10	45	10.5	5
CAFR/L-4T16-150250	4	150	250	4	16	32.7	10	45	10.5	5
CAFR/L-5T20-055080	5	55	80	5	20	32.7	10	49	10.5	5
CAFR/L-5T20-080120	5	80	120	5	20	32.7	10	49	10.5	5
CAFR/L-5T20-120180	5	120	180	5	20	32.7	10	49	10.5	5
CAFR/L-5T20-180300	5	180	300	5	20	32.7	10	49	10.5	5
CAFR/L-5T20-300000	5	300	∞	5	20	32.7	10	49	10.5	5
CAFR/L-6T25-060090	6	60	90	6	25	32.7	10	55	10.5	5
CAFR/L-6T25-090150	6	90	150	6	25	32.7	10	55	10.5	5
CAFR/L-6T25-150250	6	150	250	6	25	32.7	10	55	10.5	5
CAFR/L-6T25-250400	6	250	400	6	25	32.7	10	55	10.5	5

When groove depth is larger than (insert length - 1.5 mm), please use 1-cornered insert.
 Max. groove depth will be 15 mm with DTF insert.
 Use the right-hand insert for the right-hand holder with DTF insert.
 Not compatible with TungModularSystem
 (1) WF is calculated with the groove width (CW) in the above table.
 Torque*: Recommended clamping torque (N·m)

SPARE PARTS

Designation	Clamping screw	Wrench
CAFR/L...	BHM6-20-A	P-4

Insert	Groove width CW	Face grooving Min. machining dia. DAXMIN
DGM / DGS / SGN / DGL	3	92
DGM / DGS / SGN / DGL	4	37
DGM / DGS / SGN / DGL	5	60
DGM / DGS / DGL	6	57
DTE / DGG / DTM	3	62
DTE / DGG / DTM	4	42
DTE / DGG / DTM	5	64
DTE / DGG / DTM	6	61
DTR	3	44
DTR	4	32
DTR	5	48
DTR	6	48
DTX	3	22
DTX	4	20
DTX	5	20
DTX	6	23
DTF	3	20
DTF	4	20

Reference pages: Inserts → **F183 - F197**, Shanks and toolholders → **F180, F181**
 Standard cutting conditions → **F198**



Shank for adapter

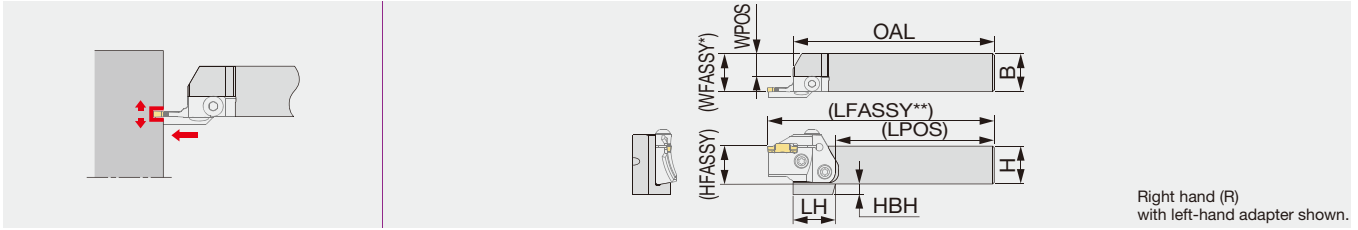

Designation	H	B	OAL	LPOS	LH	WPOSS	HFASSY	HBH	Adapter (Option)
CHSR/L2020	20	20	133	105	35	10	20	12	CAFL/R...
CHSR/L2525	25	25	133	105	28	15	25	7	CAFL/R...
CHSR/L3232	32	32	153	125	-	22	32	-	CAFL/R...

WFASSY* : Shank (WPOSS) + adapter (WF)
 LFASSY** : Shank (LPOS) + adapter (LF)
 Depend on the adapter type, the value of LFASSY or WFASSY may change.
 Not compatible with TungModularSystem



CHFVR/L

Shank for adapter, perpendicularly mounted

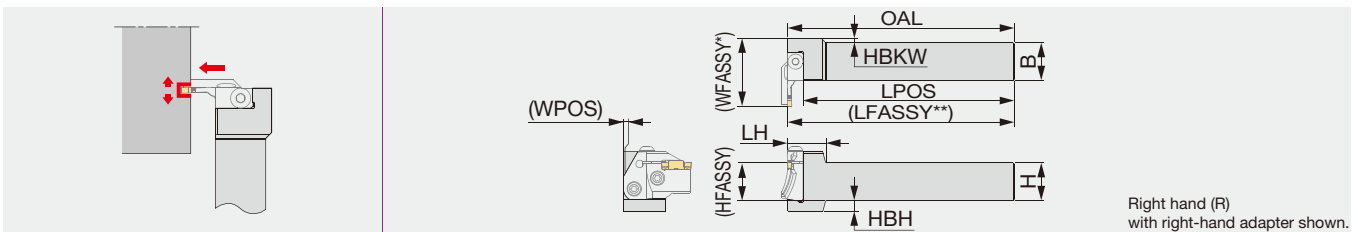

Designation	H	B	OAL	LPOS	LH	WPOSS	HBKW	HFASSY	HBH	Adapter (Option)
CHFVR/L2020	20	20	150	140	25	0	8	20	12	CAFR/L...
CHFVR/L2525	25	25	150	140	25	0	3	25	7	CAFR/L...
CHFVR/L3232	32	32	170	160	25	4	-	32	-	CAFR/L...

WFASSY* : Shank (WPOSS) + adapter (LF)
 LFASSY** : Shank (LPOS) + adapter (WF)
 Depend on the adapter type, the value of LFASSY or WFASSY may change.
 Not compatible with TungModularSystem

SPARE PARTS



Designation	Clamping screw	Wrench
CH**R/L...	CSHB-6-A	P-4

Combination of adapter and shank

Shank	External grooving adapter		Face grooving adapter	
	CAER...	CAEL...	CAFR...	CAFL...
CHSR...	●			●
CHSL...		●	●	
CHFVR...		●	●	
CHFVL...	●			●

● : Corresponding

C-CHSR/L

Toolholder with TungCap connection for adapter

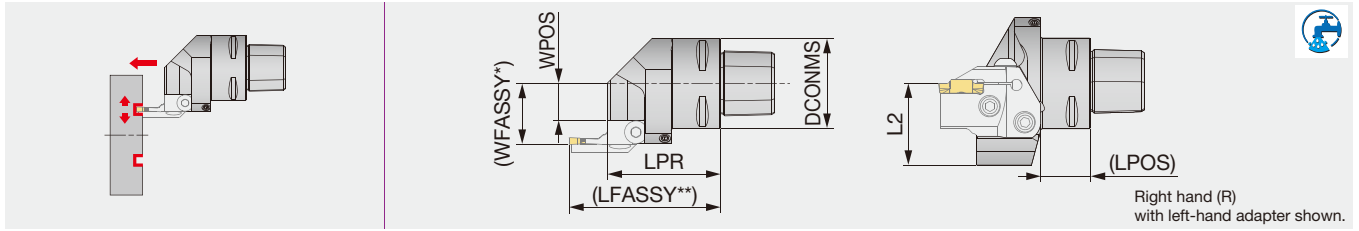

Designation	DCONMS	LPR	LPOS	L2	WPOS	Adapter (Option)
C3CHSR/L22050N	32	50	22.1	35	11.5	CAFL/R...
C4CHSR/L27050N	40	50	22.1	36	16.5	CAFL/R...
C5CHSR/L35060N	50	60	32.1	36	24.5	CAFL/R...
C6CHSR/L45065N	63	65	32.1	41	34.5	CAFL/R...

WFASSY* : Toolholder (WPOS) + adapter (WF)

LFASSY** : Toolholder (LPOS) + adapter (LF)

Depend on the adapter type, the value of LFASSY or WFASSY may change. If needed, the coolant direction can be adjusted by the nozzle.

Applicable for 7 MPa coolant. Not compatible with TungModularSystem.

C-CHFVR/L

Toolholder with TungCap connection for adapter, perpendicularly mounted

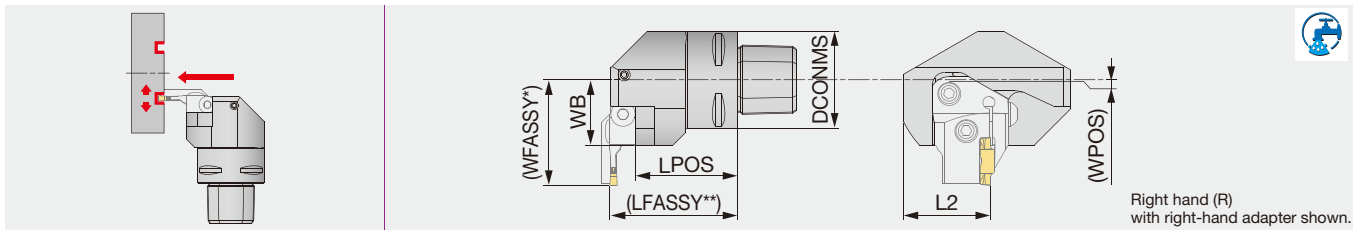

Designation	DCONMS	LPOS	L2	WB	WPOS	Adapter (Option)
C3CHFVR/L22040N	32	32.5	35	22	-5.9	CAFR/L...
C4CHFVR/L27050N	40	42.5	36	27	-0.9	CAFR/L...
C5CHFVR/L35060N	50	49.5	36	35	7.1	CAFR/L...
C6CHFVR/L45065N	63	54.5	41	45	17.1	CAFR/L...

WFASSY* : Toolholder (WPOS) + adapter (LF)

LFASSY** : Toolholder (LPOS) + adapter (WF)

Depend on the adapter type, the value of LFASSY or WFASSY may change. If needed, the coolant direction can be adjusted by the nozzle.

Applicable for 7 MPa coolant. Not compatible with TungModularSystem.

SPARE PARTS

Designation	Coolant parts	Clamping screw	Wrench
C3CH**R/L...	SATZ-M8X1-M3	CSHB-6-A	P-4
C4CH**R/L...	SATZ-M8X1-M3	CSHB-6-A	P-4
C5CH**R/L...	SATZ-M10X1-M5	CSHB-6-A	P-4
C6CH**R/L...	SATZ-M10X1-M5	CSHB-6-A	P-4

Combination of adapter and toolholder

Toolholder	External grooving adapter		Face grooving adapter	
	CAER...	CAEL...	CAFR...	CAFL...
C*CHSR...	●			●
C*CHSL...		●	●	
C*CHFVR...		●	●	
C*CHFVL...	●			●

● : Corresponding

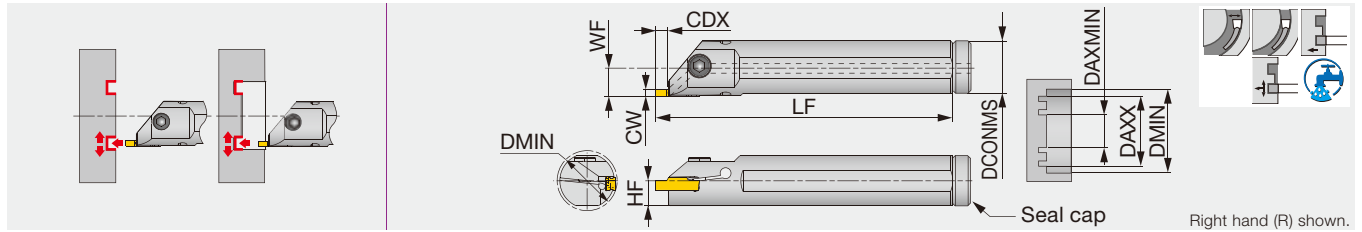

Designation	CW	Seat size	CDX	DCONMS	LF	HF	WF ⁽¹⁾	Torque*
CTIFR/L25-4T05-D270	4	2, 3, 4	5.5	25	200	11.5	13.3	5
CTIFR/L32-4T05-D340	4	2, 3, 4	5.5	32	250	15	16.8	5
CTIFR/L25-5T05-D270	6	5, 6	5.5	25	200	11.5	13.3	5
CTIFR/L32-5T05-D340	6	5, 6	5.5	32	250	15	16.8	5

Use the right-hand insert for the right-hand holder with DTF insert.
 (1) WF is calculated with the groove width CW in the above table.
 Torque*: Recommended clamping torque (N·m)

SPARE PARTS







Designation	Clamping screw	Wrench	Seal cap
CTIFR/L25-4T05-D270	CM6X1X16-A	P-5	CA-25
CTIFR/L32-4T05-D340	CM6X1X20-A	P-5	CA-32
CTIFR/L25-5T05-D270	CM6X1X16-A	P-5	CA-25
CTIFR/L32-5T05-D340	CM6X1X20-A	P-5	CA-32

Seat size	Min. machining dia.: DMIN	
	DCONMS = 25 mm	DCONMS = 32 mm
2	299	299
3	26.3	33.3
4	26.8	33.8
5	26.3	33.3
6	26.8	33.8

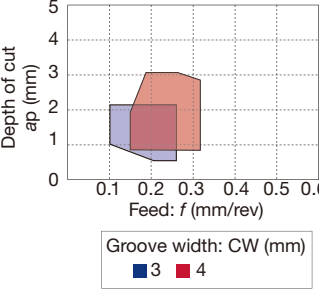
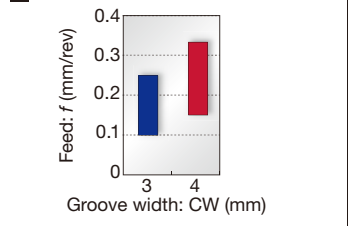
Insert	Groove width CW	Face grooving
		Min. machining dia. DAXMIN
DGM / DGS / SGN / DGL	2	295
DGM / DGS / SGN / DGL	3	92
DGM / DGS / SGN / DGL	4	37
DGM / DGS / SGN / DGL	5	60
DGM / DGS / DGL	6	57
DTX / DTM / DTR	2	295
DTE / DGG / DTM	3	62
DTE / DGG / DTM	4	42
DTE / DGG / DTM	5	64
DTE / DGG / DTM	6	61

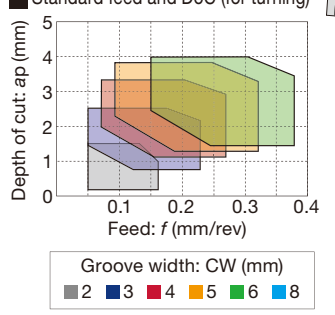
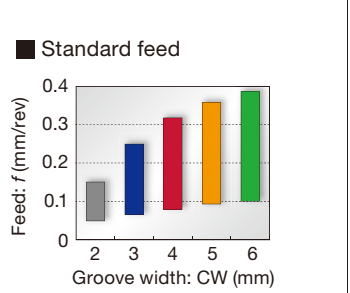

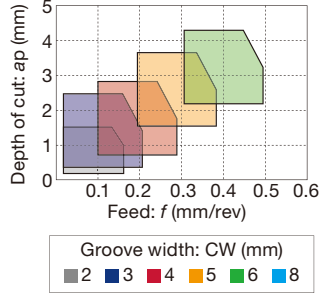
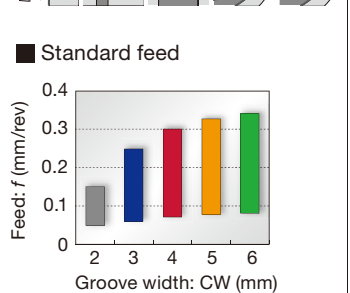

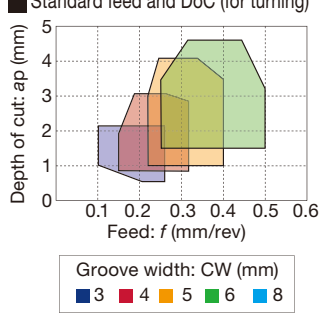
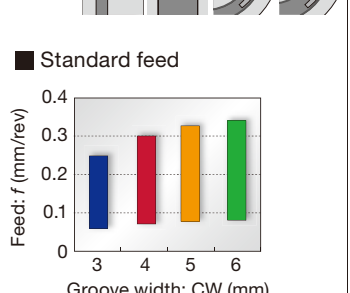

Insert	Groove width CW	Face grooving
		Min. machining dia. DAXMIN
DTR	3	44
DTR	4	32
DTR	5	48
DTR	6	48
DTX	3	22
DTX	4	20
DTX	5	20
DTX	6	23
DTF	3	20
DTF	4	20

Face grooving and turning

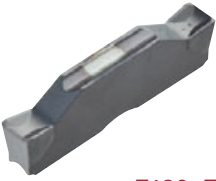
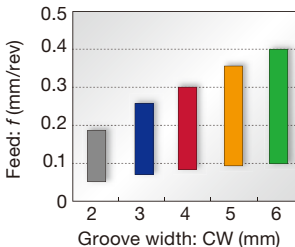
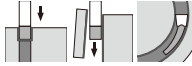
<p>DTF type (2 corners)</p> <p>First choice</p>  <p>F187</p>	<p>1st choice for face grooving</p> <p>Unique chipbreaker makes chips shorter Molded and ground insert available</p> <p>CW = 3 - 4 mm</p>	<p>Standard feed and DoC (for turning)</p> 	<p>Standard feed</p> 
<p>DTX type (2 corners)</p>  <p>F187</p>	<p>Multi-functional type</p> <p>Well balanced sharpness and strength Multi-functional insert CW = 2 - 6 mm</p>	<p>Standard feed and DoC (for turning)</p> 	<p>Standard feed</p> 
<p>DTM type (2 corners)</p>  <p>F188</p>	<p>General purpose</p> <p>1st choice for grooving and turning Suitable for light to medium cutting Excellent chip control in machining steel, alloy steel, stainless steel, and heat-resistant alloy CW = 2 - 6 mm</p>	<p>Standard feed and DoC (for turning)</p> 	<p>Standard feed</p> 
<p>DTE type (2 corners)</p>  <p>F188, F189</p>	<p>General purpose</p> <p>Unique chipbreaker makes chips shorter Molded and ground insert available CW = 2.65 - 6 mm</p>	<p>Standard feed and DoC (for turning)</p> 	<p>Standard feed</p> 

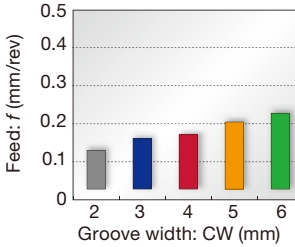
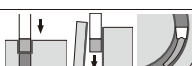

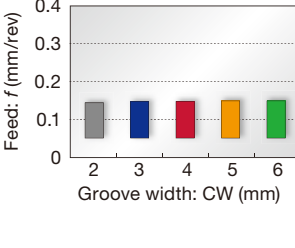
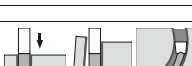
Please see page F*** for the product details.

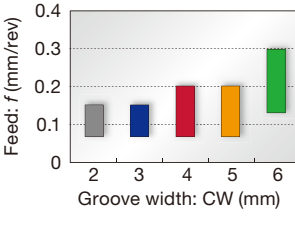
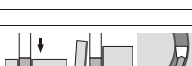
Grooving

<p>DGM type (2 corners) SGM type (1 corner)</p>  <p>F190, F191</p>	<p>1st choice for grooving and parting</p> <p>Smooth chip evacuation Well-designed edge with high strength Handed insert available CW = 2 - 6.35 mm</p>	<p>■ Standard feed</p>  <table border="1"> <caption>Standard feed for DGM/SGM</caption> <thead> <tr> <th>Groove width: CW (mm)</th> <th>Feed: f (mm/rev)</th> </tr> </thead> <tbody> <tr><td>2</td><td>0.18</td></tr> <tr><td>3</td><td>0.25</td></tr> <tr><td>4</td><td>0.28</td></tr> <tr><td>5</td><td>0.35</td></tr> <tr><td>6</td><td>0.40</td></tr> </tbody> </table>	Groove width: CW (mm)	Feed: f (mm/rev)	2	0.18	3	0.25	4	0.28	5	0.35	6	0.40	
Groove width: CW (mm)	Feed: f (mm/rev)														
2	0.18														
3	0.25														
4	0.28														
5	0.35														
6	0.40														
<p>DGS type (2 corners) SGS type (1 corner)</p>  <p>F192, F193</p>	<p>Lower cutting force and superior sharpness</p> <p>Unique-designed edge and chipbreaker Handed insert available CW = 2 - 6.35 mm</p>	<p>■ Standard feed</p>  <table border="1"> <caption>Standard feed for DGS/SGS</caption> <thead> <tr> <th>Groove width: CW (mm)</th> <th>Feed: f (mm/rev)</th> </tr> </thead> <tbody> <tr><td>2</td><td>0.12</td></tr> <tr><td>3</td><td>0.15</td></tr> <tr><td>4</td><td>0.16</td></tr> <tr><td>5</td><td>0.20</td></tr> <tr><td>6</td><td>0.22</td></tr> </tbody> </table>	Groove width: CW (mm)	Feed: f (mm/rev)	2	0.12	3	0.15	4	0.16	5	0.20	6	0.22	
Groove width: CW (mm)	Feed: f (mm/rev)														
2	0.12														
3	0.15														
4	0.16														
5	0.20														
6	0.22														
<p>DGG type (2 corners)</p>  <p>F193</p>	<p>For non-ferrous materials and titanium</p> <p>Chipbreaker with low cutting force Sharp cutting edge that prevents vibration and delivers fine surface finish CW = 2 - 6 mm</p>	<p>■ Standard feed</p>  <table border="1"> <caption>Standard feed for DGG</caption> <thead> <tr> <th>Groove width: CW (mm)</th> <th>Feed: f (mm/rev)</th> </tr> </thead> <tbody> <tr><td>2</td><td>0.14</td></tr> <tr><td>3</td><td>0.15</td></tr> <tr><td>4</td><td>0.15</td></tr> <tr><td>5</td><td>0.15</td></tr> <tr><td>6</td><td>0.15</td></tr> </tbody> </table>	Groove width: CW (mm)	Feed: f (mm/rev)	2	0.14	3	0.15	4	0.15	5	0.15	6	0.15	
Groove width: CW (mm)	Feed: f (mm/rev)														
2	0.14														
3	0.15														
4	0.15														
5	0.15														
6	0.15														
<p>DGL type (2 corners)</p>  <p>F194</p>	<p>1st choice for mild steel</p> <p>Chipbreaker with excellent chip control at low feed Suitable for mild steel that often gives difficulties in chip control CW = 2 - 6 mm</p>	<p>■ Standard feed</p>  <table border="1"> <caption>Standard feed for DGL</caption> <thead> <tr> <th>Groove width: CW (mm)</th> <th>Feed: f (mm/rev)</th> </tr> </thead> <tbody> <tr><td>2</td><td>0.15</td></tr> <tr><td>3</td><td>0.15</td></tr> <tr><td>4</td><td>0.20</td></tr> <tr><td>5</td><td>0.20</td></tr> <tr><td>6</td><td>0.30</td></tr> </tbody> </table>	Groove width: CW (mm)	Feed: f (mm/rev)	2	0.15	3	0.15	4	0.20	5	0.20	6	0.30	
Groove width: CW (mm)	Feed: f (mm/rev)														
2	0.15														
3	0.15														
4	0.20														
5	0.20														
6	0.30														

Please see page F*** for the product details.

Profiling and undercutting

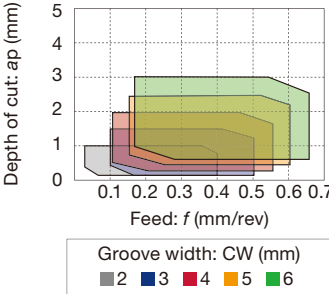
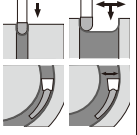

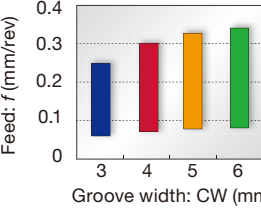
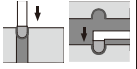
<p>DTR type (2 corners) STR type (1 corner)</p> <p>Molded DTR, STR</p>  <p>Ground DTR</p>  <p>F194, F195</p>	<p>Full radius type</p> <p>Excellent chip control Molded and ground inserts available CW = 2 - 6 mm</p>	<p>■ Standard feed and DoC (for turning)</p> 	
--	--	---	---

<p>DTIU type (2 corners)</p>  <p>F196</p>	<p>Full radius type</p> <p>Excellent chip control for undercutting CW = 3 - 6 mm</p>	<p>■ Standard feed and DoC</p> 	
---	---	---	---

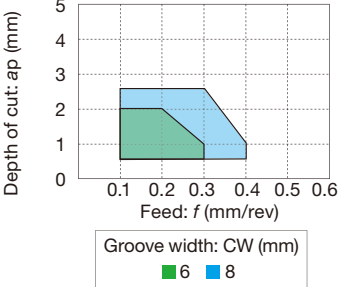
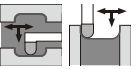

Aluminium wheel machining

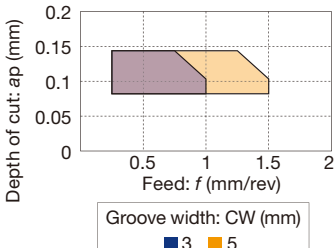
<p>DTA type (2 corners)</p>  <p>F196</p>	<p>Full radius type</p> <p>Excellent chip control For aluminium wheel profiling Ground insert CW = 6 - 8 mm</p>	<p>■ Standard feed and DoC (for turning)</p> 	
--	--	--	--

For high feed external and face turning of hardened steel parts

<p>STH type (1 corner)</p>  <p>F197</p>	<p>External and face turning of hardened steel parts</p> <p>High efficiency machining using light D.O.C. and increased feeds CW = 3, 5 mm</p>	<p>■ Standard feed and DoC (for turning)</p> 	
---	--	---	---

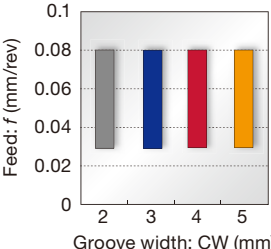
External grooving of hardened steel

<p>SGN-CBN type (1 corner)</p>  <p>F197</p>	<p>For hardened steel cutting</p> <p>Optimum cutting edge shape for grooving of hardened steels High tolerance width for finishing CW = 2 - 5 mm (CW = ±0.025 mm)</p>	<p>■ Standard feed</p> 	
---	---	---	---

Please see page F*** for the product details.

GRADE SELECTION

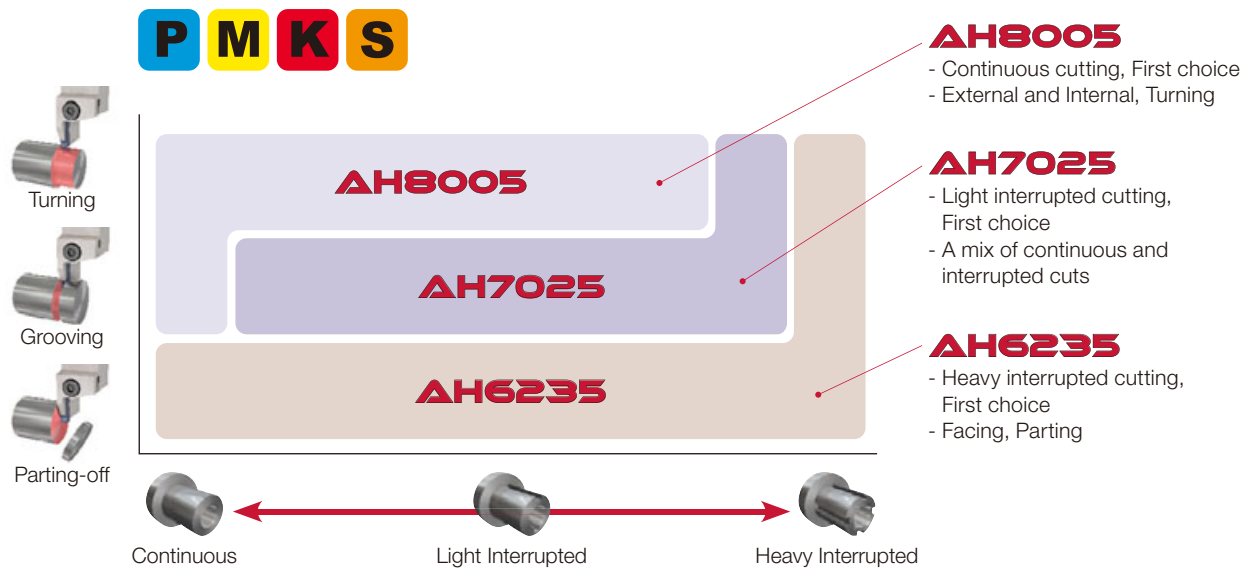

GRADES

AH8005 **P M K S**

- First choice for external, internal, and side-turning, continuous cuts

AH7025 **P M K S**

- First choice for light interrupted cuts or a mix of continuous and interrupted cuts
- New PVD coating with high Al content provides excellent adhesion strength
- Improved wear and chipping resistance

AH6235 **P M K**

- First choice for heavy interrupted cuts, as well as parting and facing applications

AH725 **P M S**

- General purpose PVD grade for high fracture resistance

T515 **K**

- First recommended grade for cast iron
- Excellent wear resistance in high speed machining

T9225 **P**

- Suitable for steel machining at high speeds
- New CVD coating and substrate deliver an outstanding balance of wear and chipping resistance

NS9530 **P**

- Advanced cermet for finish cutting of steel
- Innovative grade with incredible fracture and high wear resistance

GH130 **P M K**

- Recommended for interrupted machining
- TiCNO PVD coating layer with high wear resistance
- High hardness wear resistance

AH905 **S**

- Remarkable for machining of heat resistant alloys
- Exclusive coating layer improves adhesion strength and wear resistance

KS05F **N S**

- Recommended for non-ferrous materials and titanium

TH10 **N**

- Recommended for non-ferrous materials

BXA10 **H**

- Coated CBN grade designed for turning hardened steel parts

BX360 **H**

- Developed for grooving applications of hardened steel parts

INSERTS

DTF

Face grooving and turning

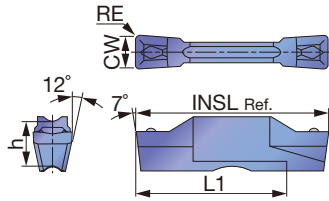

Right hand (R) shown.

P	Steel	★	★	☆	☆				★				
M	Stainless		★	☆	★								
K	Cast iron		★		☆	★			☆				
N	Non-ferrous												
S	Superalloys		★	☆									
H	Hard materials												

★ : First choice
☆ : Second choice

Designation	Seat size	HAND	CW±0.05	RE	Coated					Cermet		INSL	h	L1	
					T9225	AH7025	AH725	GH130			NS9530				
DTF3-040-R	3	R	3	0.4	●	●	●	●			●		20	5	16
DTF3-040-L	3	L	3	0.4	●	●	●	●			●		20	5	16
DTF4-040-R	4	R	4	0.4	●	●	●	●			●		20	5	16
DTF4-040-L	4	L	4	0.4	●	●	●	●			●		20	5	16

● : Line up

DTX

External, internal and face grooving, and turning

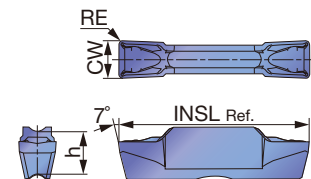

P	Steel	★	★	☆	★	☆	★		★					
M	Stainless		★	☆	★	★	★							
K	Cast iron		★		★	☆	★		☆			☆		
N	Non-ferrous											☆		
S	Superalloys		★	☆	★							★		
H	Hard materials													

★ : First choice
☆ : Second choice

Designation	Seat size	CW±0.05	RE	Coated					Cermet	Uncoated		INSL	h	
				T9225	AH7025	AH725	AH8005	GH130	AH6235	NS9530				KS05F
DTX2-020	2	2	0.2		●		●		●		●		20	5
DTX3-030	3	3	0.3	●	●	●	●	●	●		●		20	5
DTX4-040	4	4	0.4	●	●	●	●	●	●		●		20	5
DTX5-040	5	5	0.4	●	●	●	●	●	●		●		25	5.5
DTX6-080	6	6	0.8	●	●	●	●	●	●		●		25	5.5

● : Line up

Reference pages: Toolholders → **F172 - F182**, Standard cutting conditions → **F198**



DTM

External face grooving and turning

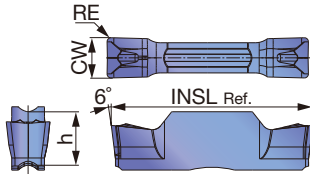

P	Steel	★	★	★						
M	Stainless	★	★	★						
K	Cast iron	★	★	★						
N	Non-ferrous									
S	Superalloys	★	★							
H	Hard materials									

★ : First choice
☆ : Second choice

Designation	Seat size	CW±0.05	RE	Coated			INSL	h
				AH7025	AH8005	AH6235		
DTM2-020	2	2	0.2	●	●	●	20	5
DTM3-030	3	3	0.3	●	●	●	20	5
DTM4-040	4	4	0.4	●	●	●	20	5
DTM4-080	4	4	0.8	●	●	●	20	5
DTM5-080	5	5	0.8	●	●	●	25	5.5
DTM6-080	6	6	0.8	●	●	●	25	5.5

● : Line up

DTE

External face grooving and turning (for high precision)

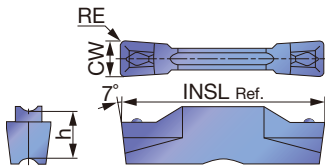

P	Steel	★	★	☆	☆					★
M	Stainless		★	☆	★					
K	Cast iron		★		☆					
N	Non-ferrous									
S	Superalloys		★	☆						
H	Hard materials									

★ : First choice
☆ : Second choice

Designation	Seat size	CW±0.02	RE	Coated				Cermet	INSL	h
				T9225	AH7025	AH725	GH130	NS9530		
DTE265-015	3	2.65	0.15	●	●	●	●	●	20	5
DTE300-020	3	3	0.2	●	●	●	●	●	20	5
DTE300-040	3	3	0.4	●	●	●	●	●	20	5
DTE315-015	3	3.15	0.15	●	●	●	●	●	20	5
DTE400-040	4	4	0.4	●	●	●	●	●	20	5
DTE400-080	4	4	0.8	●	●	●	●	●	20	5
DTE415-015	4	4.15	0.15	●	●	●	●	●	20	5
DTE478-055	5	4.78	0.55	●	●	●	●	●	25	5.5
DTE500-040	5	5	0.4	●	●	●	●	●	25	5.5
DTE500-080	5	5	0.8	●	●	●	●	●	25	5.5
DTE515-015	5	5.15	0.15	●	●	●	●		25	5.5
DTE600-080	6	6	0.8	●	●	●	●		25	5.5
DTE600-120	6	6	1.2	●	●	●	●		25	5.5

● : Line up

Reference pages: Toolholders → **F172 - F182**, Standard cutting conditions → **F198**

DTE

External face grooving and turning

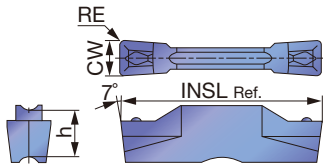

P	Steel	★		★	☆	★	☆	★	★						
M	Stainless			★	☆	★	★	★							
K	Cast iron		★	★		★	☆	★							
N	Non-ferrous														
S	Superalloys			★	☆	★									
H	Hard materials														

★ : First choice
☆ : Second choice

Designation	Seat size	CW±0.05	RE	Coated						Cermets			INSL	h	
				T9225	T515	AH7025	AH725	AH8005	GH130	AH6235	NS9530				
DTE3-020	3	3	0.2			●		●		●				20	5
DTE3-040	3	3	0.4	●	●	●	●	●	●	●	●			20	5
DTE4-040	4	4	0.4	●	●	●	●	●	●	●	●			20	5
DTE4-080	4	4	0.8			●		●		●				20	5
DTE5-040	5	5	0.4		●	●		●		●				25	5.5
DTE5-080	5	5	0.8			●		●		●				25	5.5
DTE6-080	6	6	0.8		●	●		●		●				25	5.5

● : Line up

DGM

External/face grooving and parting

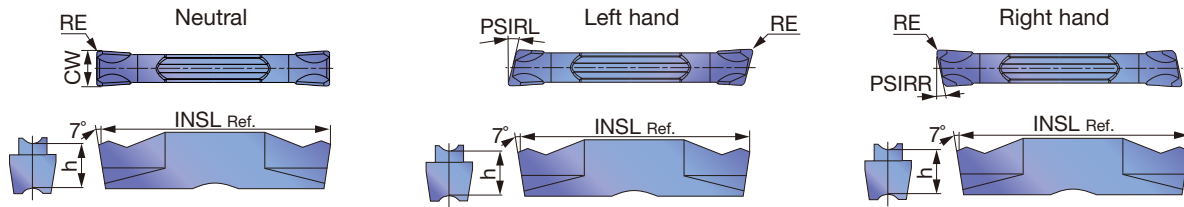

P Steel	★	★	☆	★	☆	★	★	★	★										
M Stainless		★	☆	★	★	★	★	★	★										
K Cast iron		★		★	☆	☆	★	★	★	☆									
N Non-ferrous																			☆
S Superalloys		★	☆	★	★														★
H Hard materials																			

★ : First choice
☆ : Second choice

Designation	Seat size	HAND	CW±0.05	RE	Coated						Cermet	Uncoated	INSL	h	PSIRL	PSIRR	
					T9225	AH7025	AH725	AH8005	AH905	GH130	AH6235	NS9530					KS05F
DGM2-020	2	N	2	0.2	●	●	●	●	●	●	●	●	●	20	5	0°	0°
DGM2-020-6R	2	R	2	0.2		●	●			●				20	5	0°	6°
DGM2-020-6L	2	L	2	0.2		●	●			●				20	5	6°	0°
DGM2-020-8R	2	R	2	0.2		●	●			●				20	5	0°	8°
DGM2-020-8L	2	L	2	0.2		●	●			●				20	5	8	0°
DGM2-020-15R	2	R	2	0.2		●	●			●				20	5	0°	15°
DGM2-020-15L	2	L	2	0.2		●	●			●				20	5	15°	0°
DGM2-002-15R	2	R	2	0.02			●			●				19.35	5	0°	15°
DGM2-002-15L	2	L	2	0.02			●			●				19.35	5	15°	0°
DGM2.39-020	2	N	2.39	0.2		●		●		●				20	5	0°	0°
DGM3-020	3	N	3	0.2	●	●	●	●	●	●	●	●	●	20	5	0°	0°
DGM3-020-6R	3	R	3	0.2		●	●			●				20	5	0°	6°
DGM3-020-6L	3	L	3	0.2		●	●			●				20	5	6°	0°
DGM3-002-6R	3	R	3	0.02			●			●				19.45	5	0°	6°
DGM3-002-6L	3	L	3	0.02			●			●				19.45	5	6°	0°
DGM3-020-15R	3	R	3	0.2		●	●			●				20	5	0°	15°
DGM3-020-15L	3	L	3	0.2		●	●			●				20	5	15°	0°
DGM3.18-020	3	N	3.18	0.2		●		●		●				20	5	0°	0°
DGM4-030	4	N	4	0.3	●	●	●	●	●	●	●	●	●	20	5	0°	0°
DGM4-030-4R	4	R	4	0.3		●	●			●				20	5	0°	4°
DGM4-030-4L	4	L	4	0.3		●	●			●				20	5	4°	0°
DGM4-030-15R	4	R	4	0.3		●	●			●				20	5	0°	15°
DGM4-030-15L	4	L	4	0.3		●	●			●				20	5	15°	0°
DGM4.76-040	5	N	4.76	0.4		●		●		●				25	5.5	0°	0°
DGM5-030	5	N	5	0.3	●	●	●	●	●	●	●	●	●	25	5.5	0°	0°
DGM5-030-4R	5	R	5	0.3		●	●			●				25	5.5	0°	4°
DGM6-030	6	N	6	0.3	●	●	●	●	●	●	●	●	●	25	5.5	0°	0°
DGM6.35-040	6	N	6.35	0.4		●		●		●				25	5.5	0°	0°

● : Line up

Reference pages: Toolholders → **F172 - F182**, Standard cutting conditions → **F198**

SGM

External/face deep grooving and parting

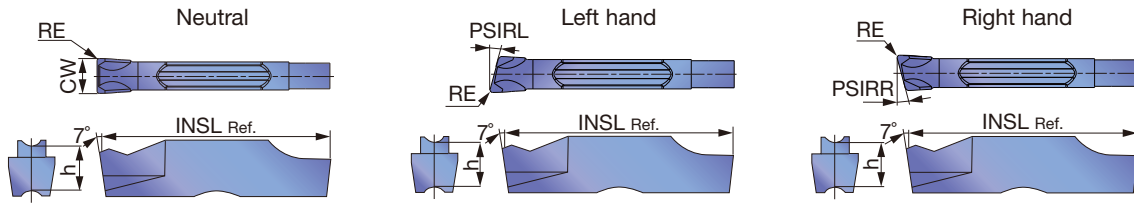

P	Steel	★	☆	★	☆	★													
M	Stainless	★	☆	★	★	★													
K	Cast iron	★		★	☆	★		☆											
N	Non-ferrous							☆											
S	Superalloys	★	☆	★				★											
H	Hard materials																		

★ : First choice
☆ : Second choice

Designation	Seat size	HAND	CW±0.05	RE	Coated					Uncoated		INSL	h	PSIRL	PSIRR	
					AH7025	AH725	AH8005	GH130	AH6235	KS05F						
SGM2-020	2	N	2	0.2	●	●	●	●	●	●			20	5	0°	0°
SGM2-020-6R	2	R	2	0.2	●	●		●					20	5	0°	6°
SGM2-020-6L	2	L	2	0.2	●	●		●					20	5	6°	0°
SGM3-020	3	N	3	0.2	●	●	●	●	●	●			20	5	0°	0°
SGM3-020-6R	3	R	3	0.2	●	●		●					20	5	0°	6°
SGM3-020-6L	3	L	3	0.2	●	●		●					20	5	6°	0°
SGM3-020-15R	3	R	3	0.2	●	●		●					20	5	0°	15°
SGM3-020-15L	3	L	3	0.2	●	●		●					20	5	15°	0°
SGM4-030	4	N	4	0.3	●	●	●	●	●	●			20	5	0°	0°
SGM4-030-4R	4	R	4	0.3	●	●		●					20	5	0°	4°
SGM4-030-4L	4	L	4	0.3	●	●		●					20	5	4°	0°
SGM5-030	5	N	5	0.3	●	●	●	●	●	●			25	5.5	0°	0°
SGM6-030	6	N	6	0.3	●	●	●	●	●	●			25	5.5	0°	0°

● : Line up

External/face grooving and parting

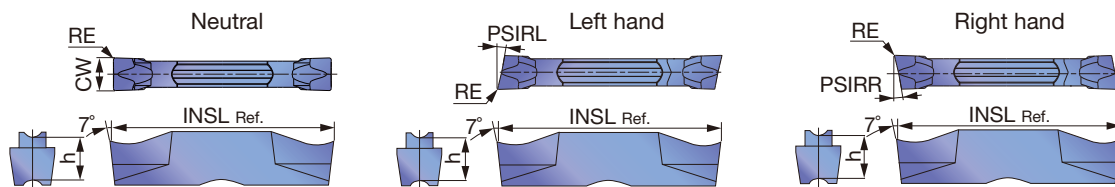

P	Steel	★	★	☆	★	☆	★	★						
M	Stainless		★	☆	★	★	★							
K	Cast iron		★		★	☆	★		☆					
N	Non-ferrous											☆		
S	Superalloys		★	☆	★							★		
H	Hard materials													

★ : First choice
☆ : Second choice

Designation	Seat size	HAND	CW±0.05	RE	Coated						Cermet		Uncoated		INSL	h	PSIRL	PSIRR
					T9225	AH7025	AH725	AH8005	GH130	AH6235	NS9530		KS05F					
DGS2-005	2	N	2	0.05			●								20	5	0°	0°
DGS2-010	2	N	2	0.1			●								20	5	0°	0°
DGS2-020	2	N	2	0.2	●	●	●	●	●	●	●		●		20	5	0°	0°
DGS2-020-6R	2	R	2	0.2		●	●		●						20	5	0°	6°
DGS2-020-6L	2	L	2	0.2		●	●		●						20	5	6°	0°
DGS2-002-6R	2	R	2	0.02			●		●						19.5	5	0°	6°
DGS2-002-6L	2	L	2	0.02			●		●						19.5	5	6°	0°
DGS2-020-15R	2	R	2	0.2		●	●		●						20	5	0°	15°
DGS2-020-15L	2	L	2	0.2		●	●		●						20	5	15°	0°
DGS2-002-15R	2	R	2	0.02			●		●						19.5	5	0°	15°
DGS2-002-15L	2	L	2	0.02			●		●						19.5	5	15°	0°
DGS2.39-020	2	N	2.39	0.2		●		●		●					20	5	0°	0°
DGS3-020	3	N	3	0.2	●	●	●	●	●	●	●		●		20	5	0°	0°
DGS3-020-6R	3	R	3	0.2		●	●		●						20	5	0°	6°
DGS3-020-6L	3	L	3	0.2		●	●		●						20	5	6°	0°
DGS3-002-6R	3	R	3	0.02			●		●						19.45	5	0°	6°
DGS3-002-6L	3	L	3	0.02			●		●						19.45	5	6°	0°
DGS3-020-15R	3	R	3	0.2		●	●		●						20	5	0°	15°
DGS3-020-15L	3	L	3	0.2		●	●		●						20	5	15°	0°
DGS3-002-15R	3	R	3	0.02			●		●						19.45	5	0°	15°
DGS3-002-15L	3	L	3	0.02			●		●						19.45	5	15°	0°
DGS3.18-020	3	N	3.18	0.2		●		●		●					20	5	0°	0°
DGS4-030	4	N	4	0.3	●	●	●	●	●	●	●		●		20	5	0°	0°
DGS4-030-4R	4	R	4	0.3		●	●		●						20	5	0°	4°
DGS4-030-4L	4	L	4	0.3		●	●		●						20	5	4°	0°
DGS4.76-040	5	N	4.76	0.4		●		●		●					25	5.5	0°	0°
DGS5-030	5	N	5	0.3	●	●	●	●	●	●	●		●		25	5.5	0°	0°
DGS6-030	6	N	6	0.3	●	●	●	●	●	●	●		●		25	5.5	0°	0°
DGS6.35-040	6	N	6.35	0.4		●		●		●					25	5.5	0°	0°

● : Line up

Caution

The tool will interfere with the workpiece when grooving larger diameters than øDmax.

Designation	øDmax (mm)	Designation	øDmax (mm)
DGM2-002-15R/L	28	DGS2-002-15R/L	28
DGM3-002-15R/L	29	DGS3-002-15R/L	29
DGM4-030-15R/L	30	SGS3-020-15R/L	103
SGM3-020-15R/L	103	SGS3-002-15R/L	34

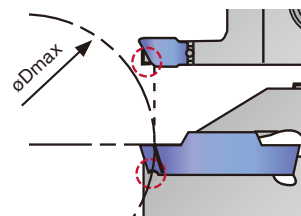

SGS

External/face deep grooving and parting

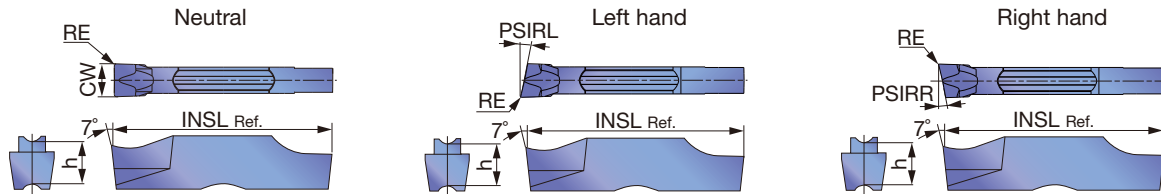

P Steel	★	☆	★	☆	★								
M Stainless	★	☆	★	★	★								
K Cast iron	★		★	☆	★		☆						
N Non-ferrous							☆						
S Superalloys	★	☆	★				★						
H Hard materials													

★ : First choice
☆ : Second choice

Designation	Seat size	HAND	CW±0.05	RE	Coated					Uncoated				INSL	h	PSIRL	PSIRR
					AH7025	AH725	AH8005	GH130	AH6235	KS05F							
SGS2-020	2	N	2	0.2	●	●	●	●	●	●				20	5	0°	0°
SGS2-020-6R	2	R	2	0.2	●	●	●	●						20	5	0°	6°
SGS2-020-6L	2	L	2	0.2	●	●	●	●						20	5	6°	0°
SGS2-020-15R	2	R	2	0.2	●	●	●	●						20	5	0°	15°
SGS2-020-15L	2	L	2	0.2	●	●	●	●						20	5	15°	0°
SGS3-020	3	N	3	0.2	●	●	●	●	●	●				20	5	0°	0°
SGS3-020-6R	3	R	3	0.2	●	●	●	●						20	5	0°	6°
SGS3-020-6L	3	L	3	0.2	●	●	●	●						20	5	6°	0°
SGS3-002-6R	3	R	3	0.02		●	●	●						19.8	5	0°	6°
SGS3-002-6L	3	L	3	0.02		●	●	●						19.8	5	6°	0°
SGS3-020-15R	3	R	3	0.2	●	●	●	●						20	5	0°	15°
SGS3-020-15L	3	L	3	0.2	●	●	●	●						20	5	15°	0°
SGS3-002-15R	3	R	3	0.02		●	●	●						19.8	5	0°	15°
SGS3-002-15L	3	L	3	0.02		●	●	●						19.8	5	15°	0°
SGS4-030	4	N	4	0.3	●	●	●	●	●	●				20	5	0°	0°
SGS5-030	5	N	5	0.3	●	●	●	●	●	●				25	5.5	0°	0°
SGS6-030	6	N	6	0.3	●	●	●	●	●	●				25	5.5	0°	0°

● : Line up

DGG

External/face grooving (for high precision)

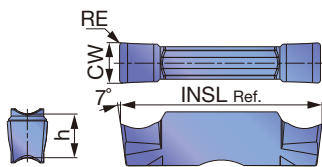

P Steel	★		★										
M Stainless	★												
K Cast iron	★		☆			☆							
N Non-ferrous						★							
S Superalloys	★					☆							
H Hard materials													

★ : First choice
☆ : Second choice

Designation	Seat size	CW±0.02	RE	Coated		Cermet		Uncoated				INSL	h	
				AH7025		NS9530		KS05F						
DGG200-020	2	2	0.2	●		●		●					20	5
DGG300-020	3	3	0.2	●		●		●					20	5
DGG400-040	4	4	0.4	●		●		●					20	5
DGG500-040	5	5	0.4	●		●		●					25	5.5
DGG600-040	6	6	0.4	●		●		●					25	5.5

● : Line up

Reference pages: Toolholders → **F172 - F182**, Standard cutting conditions → **F198**

DGL

External/face grooving and parting

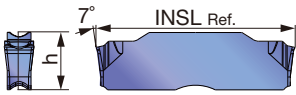
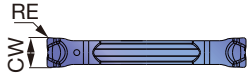

P	Steel	★	★	★																
M	Stainless	★	★	★																
K	Cast iron	★	★	★																
N	Non-ferrous																			
S	Superalloys	★	★																	
H	Hard materials																			

★ : First choice
☆ : Second choice

Designation	Seat size	CW±0.05	RE	Coated				INSL	h
				AH7025	AH8005	AH6235			
DGL2-020	2	2	0.2	●	●	●		20	5
DGL3-025	3	3	0.25	●	●	●		20	5
DGL4-030	4	4	0.3	●	●	●		20	5
DGL5-030	5	5	0.3	●	●	●		25	5.5
DGL6-080	6	6	0.8	●	●	●		25	5.5

● : Line up

DTR

Profiling and undercutting (for high precision)

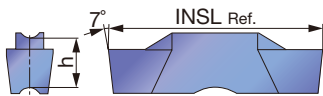
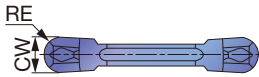

P	Steel	★	★	☆	☆															
M	Stainless	★	★	☆	★															
K	Cast iron	★	★	☆	☆															
N	Non-ferrous																			
S	Superalloys	★	☆																	
H	Hard materials																			

★ : First choice
☆ : Second choice

Designation	Seat size	CW±0.02	RE	Coated				Cermet	INSL	h
				T9225	AH7025	AH725	GH130	NS9530		
DTR300-150	3	3	1.5	●	●	●	●	●	20	5
DTR400-200	4	4	2	●	●	●	●	●	20	5
DTR478-239	5	4.78	2.39	●	●	●	●	●	25	5.5
DTR500-250	5	5	2.5	●	●	●	●	●	25	5.5
DTR600-300	6	6	3	●	●	●	●	●	25	5.5

● : Line up

Reference pages: Toolholders → **F172 - F182**, Standard cutting conditions → **F198**

DTR

Profiling and undercutting

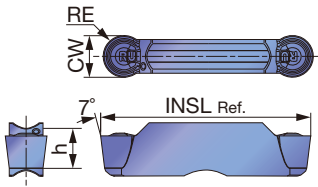

P Steel	★	★	☆	★	☆	★	★	★	★									
M Stainless		★	☆	★		★	★											
K Cast iron		★		★	☆	☆	★			☆				☆				
N Non-ferrous														☆				
S Superalloys		★	☆	★	★									★				
H Hard materials																		

★ : First choice
☆ : Second choice

Designation	Seat size	CW±0.05	RE	Coated						Cermet		Uncoated		INSL	h
				T9225	AH7025	AH725	AH8005	AH905	GH130	AH6235	NS9530		KS05F		
DTR2-100	2	2	1	●	●	●	●	●	●	●	●	●	●	20	5
DTR3-150	3	3	1.5	●	●	●	●	●	●	●	●	●	●	20	5
DTR4-200	4	4	2	●	●	●	●	●	●	●	●	●	●	20	5
DTR5-250	5	5	2.5	●	●	●	●	●	●	●	●	●	●	25	5.5
DTR6-300	6	6	3	●	●	●	●	●	●	●	●	●	●	25	5.5

● : Line up

STR

Profiling and undercutting

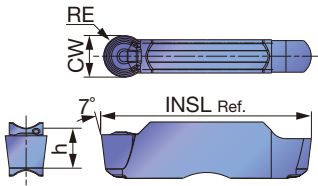

P Steel	★	★																
M Stainless	★	★																
K Cast iron	★	★								☆								
N Non-ferrous										☆								
S Superalloys	★	★								★								
H Hard materials																		

★ : First choice
☆ : Second choice

Designation	Seat size	CW±0.05	RE	Coated				Uncoated				INSL	h		
				AH7025	AH8005			KS05F							
STR2-100	2	2	1	●	●					●				20	5
STR3-150	3	3	1.5	●	●					●				20	5
STR4-200	4	4	2	●	●					●				20	5
STR5-250	5	5	2.5	●	●					●				25	5.5
STR6-300	6	6	3	●	●					●				25	5.5

● : Line up

DTIU

Profiling and undercutting (for high precision)

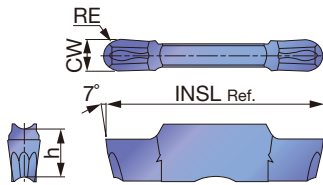

P	Steel	★	☆	☆																
M	Stainless	★	☆	★																
K	Cast iron	★		☆																
N	Non-ferrous				★															
S	Superalloys	★	☆																	
H	Hard materials																			

★ : First choice
☆ : Second choice

Designation	Seat size	CW±0.02	RE	Coated										INSL	h			
				AH7025	AH725	GH130												
DTIU300-150	3	3	1.5	●	●	●											20	5
DTIU400-200	4	4	2	●	●	●											20	5
DTIU500-250	5	5	2.5	●	●	●											25	5.5
DTIU600-300	6	6	3	●	●	●											25	5.5

● : Line up

DTA

Aluminium wheel machining (for high precision)

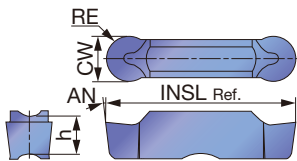

P	Steel																			
M	Stainless																			
K	Cast iron																			
N	Non-ferrous			★																
S	Superalloys																			
H	Hard materials																			

★ : First choice
☆ : Second choice

Designation	Seat size	CW±0.02	RE	Uncoated										INSL	h	AN			
				TH10															
DTA600-300	6	6	3	●													25	5.5	7°

● : Line up

Reference pages: Toolholders → **F172 - F182**, Standard cutting conditions → **F198**

STH

External and face turning

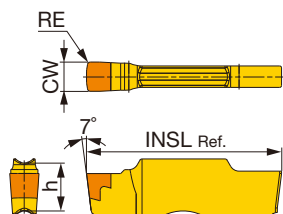

P	Steel								
M	Stainless								
K	Cast iron								
N	Non-ferrous								
S	Superalloys								
H	Hard materials	★							★ : First choice

Designation	Seat size	CW±0.025	RE	CBN						INSL	h
				BXA10							
STH300-SR	3	3	0.3	●						20	5
STH500-SR	5	5	0.3	●						25	5.5

● : Line up

SGN

External/face grooving

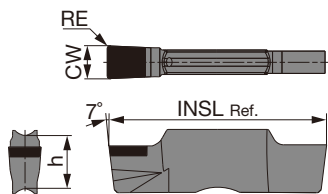

P	Steel								
M	Stainless								
K	Cast iron								
N	Non-ferrous								
S	Superalloys								
H	Hard materials	★							★ : First choice ☆ : Second choice

Designation	Seat size	CW±0.025	RE	CBN						INSL	h	Condition		
				BX360								Continuous	Light interrupted	Heavy interrupted
SGN200-020	2	2	0.2	●						20	5	○		
SGN200-020-S	2	2	0.2	●						20	5		○	
SGN200-020-H	2	2	0.2	●						20	5			○
SGN300-020	3	3	0.2	●						20	5	○		
SGN300-020-S	3	3	0.2	●						20	5		○	
SGN300-020-H	3	3	0.2	●						20	5			○
SGN400-020	4	4	0.2	●						20	5	○		
SGN400-020-S	4	4	0.2	●						20	5		○	
SGN400-020-H	4	4	0.2	●						20	5			○
SGN500-020-S	5	5	0.2	●						25	5.5		○	
SGN500-020-H	5	5	0.2	●						25	5.5			○

● : Line up

Edge preparations

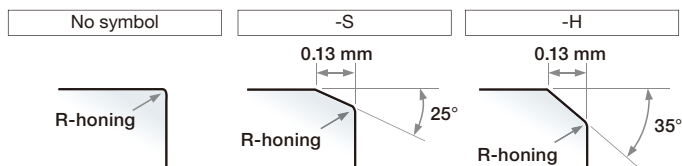

Reference pages: Toolholders → **F172 - F182**, Standard cutting conditions → **F198**

STANDARD CUTTING CONDITIONS

ISO	Workpiece material	Hardness	Priority	Grade	Cutting speed Vc (m/min)
P	Steel S45C, SCM435, etc. C45, 34CrMo4, etc.	< 300 HB	First choice	AH7025, AH725	50 - 180
		< 300 HB	Wear resistance	T9225, AH8005	80 - 300
		< 300 HB	Impact resistance	AH6235, GH130	50 - 120
		< 300 HB	Surface quality	NS9530	80 - 220
M	Stainless steel SUS303, SUS304, etc. X10CrNiS18-9, X5CrNi18-9, etc.	< 200 HB	First choice	AH7025, AH725	50 - 120
		< 200 HB	Wear resistance	AH8005	50 - 120
		< 200 HB	Impact resistance	AH6235, GH130	50 - 120
K	Grey cast iron FC250, etc. 250, etc.	-	First choice	T515	150 - 700
		-	Impact resistance	AH8005, AH7025, AH6235, GH130	50 - 180
	Ductile cast iron FCD450, etc. 450-10S, etc.	-	First choice	T515	150 - 300
		-	Impact resistance	AH8005, AH7025, AH6235, GH130	50 - 120
N	Aluminium alloys Si < 12%	-	First choice	TH10	100 - 500
		-	First choice	KS05F	100 - 600
S	Superalloys Inconel718, etc.	< HRC 40	First choice	AH8005	20 - 60
		< HRC 40	Impact resistance	AH7025, AH725, AH6235	20 - 40
	Titanium alloys Ti-6Al-4V, etc.	< HRC 40	First choice	KS05F	20 - 100
		< HRC 40	Impact resistance	AH7025, AH725	20 - 80

Please see page **F183 - F185** for feed: f (mm/rev).

STH

ISO	Grade	CW	Application	Cutting speed Vc (m/min)	Depth of cut ap (mm)	Feed f (mm/rev)
H	BXA10	3	External turning	100 - 230	0.08 - 0.12	0.4 - 1
			Face turning	100 - 230	0.08 - 0.12	0.4 - 0.8
		5	External turning	100 - 230	0.08 - 0.12	0.5 - 1.5
			Face turning	100 - 230	0.08 - 0.12	0.5 - 0.8

SGN

ISO	Grade	Edge preparation	Workpiece condition	Cutting speed Vc (m/min)	Feed f (mm/rev)
H	BX360	No symbol	Continuous	80 - 150	0.03 - 0.08
		-S	Light interrupted	50 - 120	0.03 - 0.08
		-H	Heavy interrupted	40 - 100	0.03 - 0.06

Face grooving toolholder with round shank

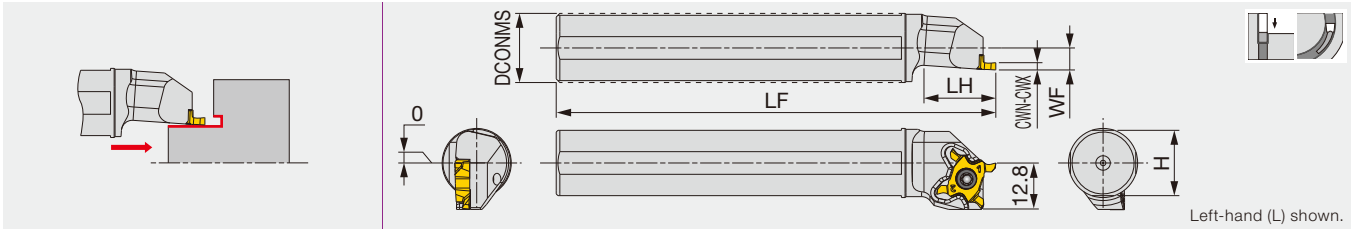

Designation	CWN	CWX	DCONMS	LF	LH	H	WF	Insert	Torque*
JS16F-STCFL18	0.33	3.18	16	85	20	15	6	TCF18L...	1.2
JS19G-STCFL18	0.33	3.18	19.05	90	20	18	6	TCF18L...	1.2
JS19X-STCFL18	0.33	3.18	19.05	120	20	18	6	TCF18L...	1.2
JS20G-STCFL18	0.33	3.18	20	90	20	19	6	TCF18L...	1.2
JS20X-STCFL18	0.33	3.18	20	120	20	19	6	TCF18L...	1.2
JS22X-STCFL18	0.33	3.18	22	120	20	21	6	TCF18L...	1.2
JS25H-STCFL18	0.33	3.18	25	100	20	24	6	TCF18L...	1.2
JS254X-STCFL18	0.33	3.18	25.4	120	20	24.5	6	TCF18L...	1.2

Note: The left hand insert (L) is used for the left hand toolholders (L).
Torque*: Recommended clamping torque: N·m

STCFVR-18

Face grooving toolholder with square shank, for Swiss lathes

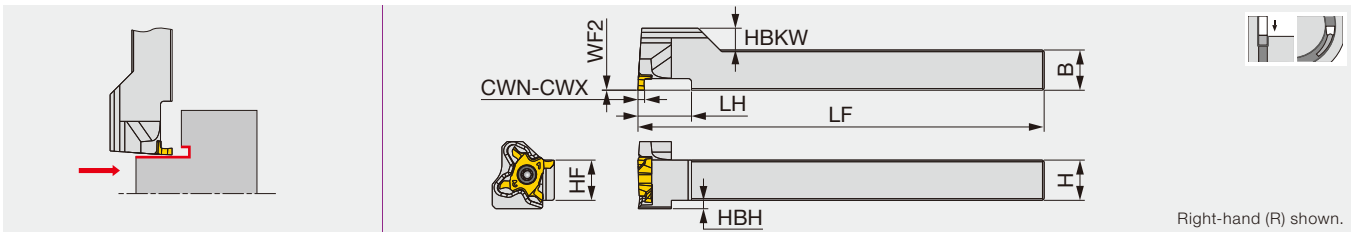

Designation	CWN	CWX	H	B	LF	LH	HF	WF2	HBKW	HBH	Insert	Torque*
STCFVR1010H18	0.33	3.18	10	10	100	12	10	0	8.5	4.5	TCF18L...	1.2
STCFVR1212F18	0.33	3.18	12	12	85	16	12	0	6.5	2.5	TCF18L...	1.2
STCFVR1212X18	0.33	3.18	12	12	120	16	12	0	6.5	2.5	TCF18L...	1.2
STCFVR1616X18	0.33	3.18	16	16	120	20	16	0	2.5	0	TCF18L...	1.2

Note: The left hand insert (L) is used for the right hand toolholders (R).
Torque*: Recommended clamping torque: N·m

SPARE PARTS

Designation	Clamping screw	Wrench
JS**-STCFL18, STCFVR**18	CSTC-4L100DR	T-1008/5



Precision grooving tools with uniquely shaped insert for swiss type machine and general lathes

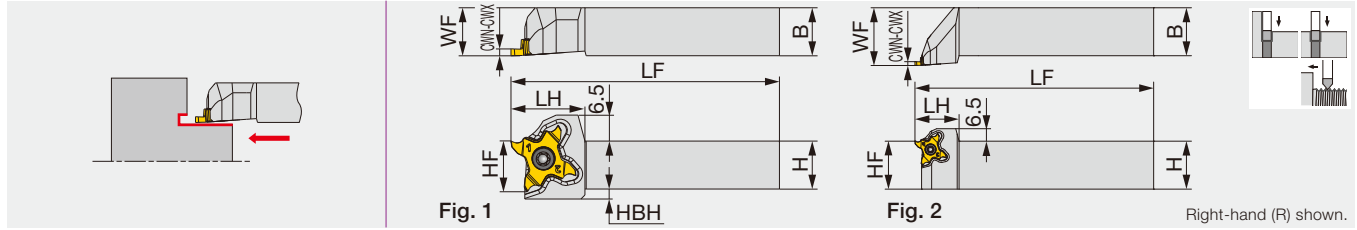

Designation	CWN	CWX	H	B	LF	LH	HF	WF	HBH	Insert	Torque*	Fig.
STCR/L1010X18	0.33	3.18	10	10	120	18.5	10	10	4.5	TC*18...	1.2	1
STCR/L1212F18	0.33	3.18	12	12	85	18.5	12	12	2.5	TC*18...	1.2	1
STCR/L1212X18	0.33	3.18	12	12	120	18.5	12	12	2.5	TC*18...	1.2	1
STCR/L1616X18	0.33	3.18	16	16	120	18.5	16	16	-	TC*18...	1.2	1
STCR/L2020H18	0.33	3.18	20	20	100	18.5	20	20	-	TC*18...	1.2	1
STCR/L2020X18	0.33	3.18	20	20	120	23	20	25	-	TC*18...	1.2	2
STCR/L2525Z18	0.33	3.18	25	25	135	23	25	30	-	TC*18...	1.2	2

The right hand insert (TC*18R...) is used for the right hand toolholders (STCR...), and the left hand insert is used for the left hand toolholders

*Torque: Recommended clamping torque: N·m

STCR/L-18-CHP

Tube connection

Threading tool - for external threading with high pressure coolant capability

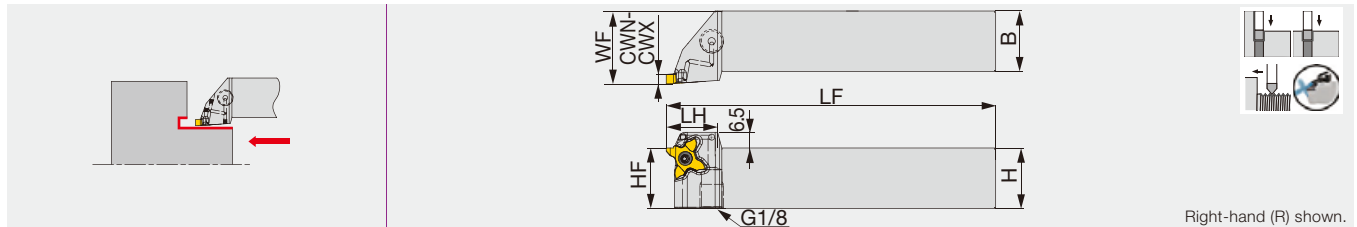

Designation	CWN	CWX	H	B	LF	LH	HBL	HF	WF	HBH	Insert	Torque*
STCR/L2020X18-CHP	0.33	3.18	20	20	120	23	-	20	25	-	TC*18...	1.2
STCR/L2525Z18-CHP	0.33	3.18	25	25	135	23	-	25	30	-	TC*18...	1.2

Use the right hand insert (TC*18R...) with the right hand toolholders (STCR...). Use the left hand insert (TC*18L...) with the left hand holder (STCL...).

*Torque: Recommended torque (N·m) for clamping

STCAR/L18-CHP

External grooving and threading adapter, with high pressure coolant capability

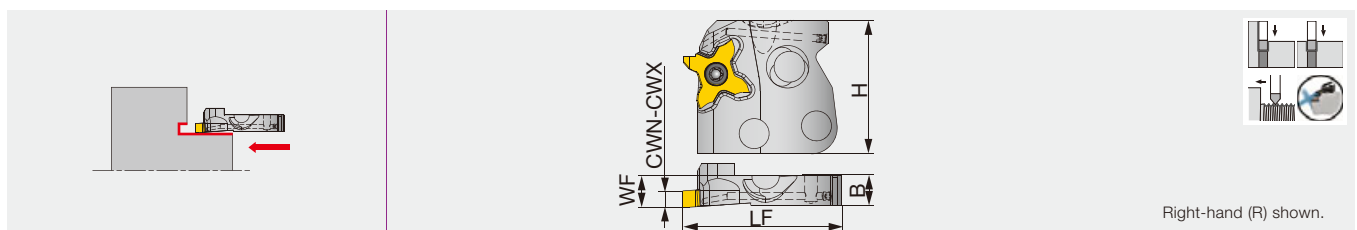

Designation	CWN	CWX	WF	H	LF	B	Insert	Torque*
STCAR/L18-CHP	0.33	3.18	7.5	33	38	7.2	TC*18...	1.2

Use the right hand insert (TC*18R...) with the right hand adapter (STCAR...). Use the left hand insert (TC*18L...) with the left hand adapter (STCAL...).

*Torque: Recommended torque (N·m) for clamping

SPARE PARTS

Designation	Clamping screw	Wrench
STCL**18, STCL**18-CHP, STCAL18-CHP	CSTC-4L100DR	T-1008/5
STCR**18, STCR**18-CHP, STCAR18-CHP	CSTC-4L100DL	T-1008/5

Reference pages: STCR/L-18: Inserts → [F204 - F211](#), Standard cutting conditions → [F212](#)

STCR/L-18-CHP: Inserts → [F204 - F211](#), Standard cutting conditions → [F212](#)

Parts for coolant hose → [F266](#)

STCAR/L18-CHP: Inserts → [F204 - F211](#), Shanks and toolholders → [F201 - F203](#)

Standard cutting conditions → [F212](#), Technical Reference → [L053](#)

CHSR/L-CHP

Tube connection

Shank for adapter, with high pressure coolant capability

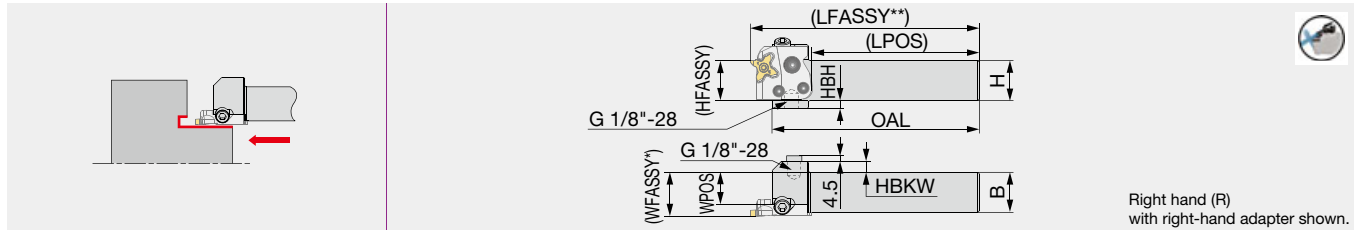

Right hand (R)
with right-hand adapter shown.

Designation	H	B	OAL	LPOS	WPOS	HBKW	HFASSY	HBH	Adapter (Option)	Torque*
CHSR/L2020-CHP	20	20	130	105.5	15.1	12	20	10	STCAR/L18-CHP	6.5
CHSR/L2525-CHP	25	25	130	105.5	20.1	7	25	5	STCAR/L18-CHP	6.5

WFASSY* : Shank (WPOS) + adapter (WF)

LFASSY** : Shank (LPOS) + adapter (LF)

Depend on the adapter type, the value of LFASSY or WFASSY may change.

Torque*: Recommended clamping torque (N·m)

Applicable for 30 MPa coolant

Please see page L053 for instructions on installing and removing the adapter or the insert.

CHSR/L-CHP-MC

Direct connection

Shank for adapter, with high pressure coolant capability

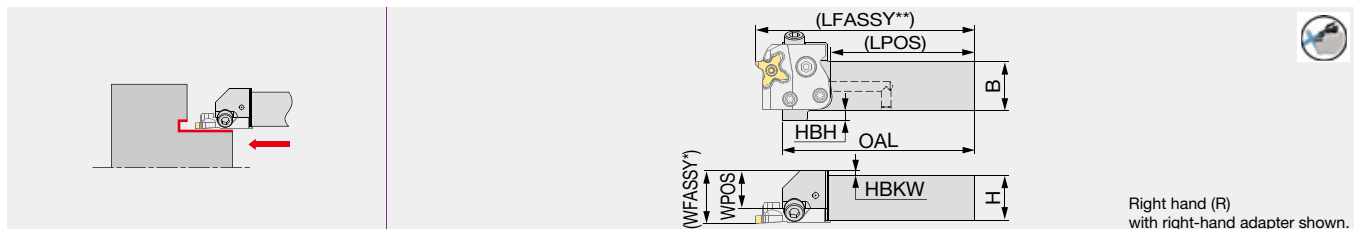

Right hand (R)
with right-hand adapter shown.

Designation	H	B	OAL	LPOS	WPOS	HBKW	HBH	Adapter (Option)	Torque*
CHSR/L2020-CHP-MC	20	20	98	73.5	14	6	10	STCAR/L18-CHP	6.5
CHSR/L2525-CHP-MC	25	25	98	73.5	19	-	5	STCAR/L18-CHP	6.5

WFASSY* : Shank (WPOS) + adapter (WF)

LFASSY** : Shank (LPOS) + adapter (LF)

Depend on the adapter type, the value of LFASSY or WFASSY may change.

Torque*: Recommended clamping torque (N·m)

Applicable for 30 MPa coolant

Please see page L053 for instructions on installing and removing the adapter or the insert.

SPARE PARTS

Designation	Clamping screw 1	Wrench 1	Clamping screw 2	Clamping screw 3	Wrench 2	O-ring	Plug
CHSR/L*-CHP	SR M5-04451	T-20/5	SR M6X12DIN6912	SR M6X20-XT	HW5.0	OR 5X1N	PLUGG1/8ISO1179
CHSR/L*-CHP-MC	SR M5-04451	T-20/5	SR M6X12DIN6912	SR M6X20-XT	HW5.0	OR 5X1N	-

Recommended clamping torque (N·m)

Clamping screw	Torque (N·m)
SR M5-04451	2.5
SR M6X12DIN6912	6.5
SR M6X20-XT	6.5

Combination of adapter and shank

Shank	Adapter	
	STCAR18-CHP	STCAL18-CHP
CHSR**-CHP (-MC)	●	
CHSL**-CHP (-MC)		●
CHFVR**-CHP		●
CHFVL**-CHP	●	

● : Corresponding

Reference pages: Inserts → F204 - F211, Adapters → F200, Standard cutting conditions → F212
Parts for coolant hose → F266, Technical Reference → L053

Shank for perpendicularly-mounted adapter, with high pressure coolant capability

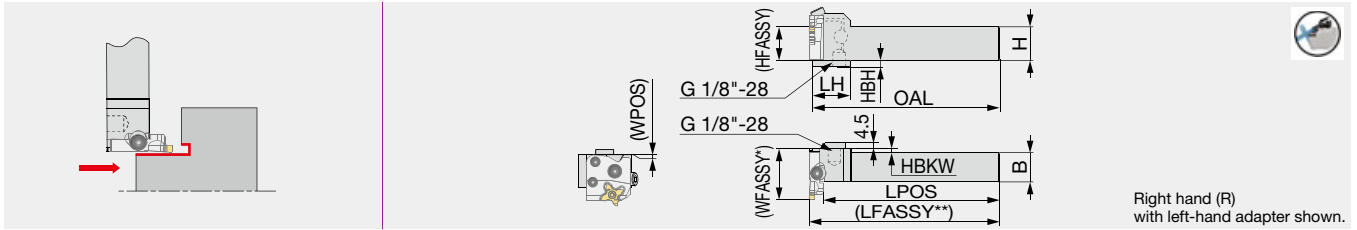

Right hand (R)
with left-hand adapter shown.

Designation	H	B	OAL	LH	LPOS	WPOS	HBKW	HFASSY	HBH	Adapter (Option)	Torque*
CHFVR/L2020-CHP	20	20	140	28	135.1	0.5	5	20	10	STCAL/R18-CHP	6.5
CHFVR/L2525-CHP	25	25	140	28	135.1	0.5	0	25	5	STCAL/R18-CHP	6.5

WFASSY* : Shank (WPOS) + adapter (LF)

LFASSY** : Shank (LPOS) + adapter (WF)

Depend on the adapter type, the value of LFASSY or WFASSY may change.

Torque*: Recommended clamping torque (N·m)

Applicable for 30 MPa coolant

Please see page L053 for instructions on installing and removing the adapter or the insert.

SPARE PARTS

Designation	Clamping screw 1	Wrench 1	Clamping screw 2	Clamping screw 3	Wrench 2	O-ring	Plug
CHFVR/L...	SR M5-04451	T-20/5	SR M6X12DIN6912	SR M6X20-XT	HW5.0	OR 5X1N	PLUGG1/8ISO1179

Recommended clamping torque (N·m)

Clamping screw	Torque (N·m)
SR M5-04451	2.5
SR M6X12DIN6912	6.5
SR M6X20-XT	6.5

Combination of adapter and shank

Shank	Adapter	
	STCAR18-CHP	STCAL18-CHP
CHSR**-CHP (-MC)	●	
CHSL**-CHP (-MC)		●
CHFVR**-CHP		●
CHFVL**-CHP	●	

● : Corresponding

C*CHSN-CHP

Direct connection

Toolholder with TungCap connection, for adapter, with high pressure coolant capability

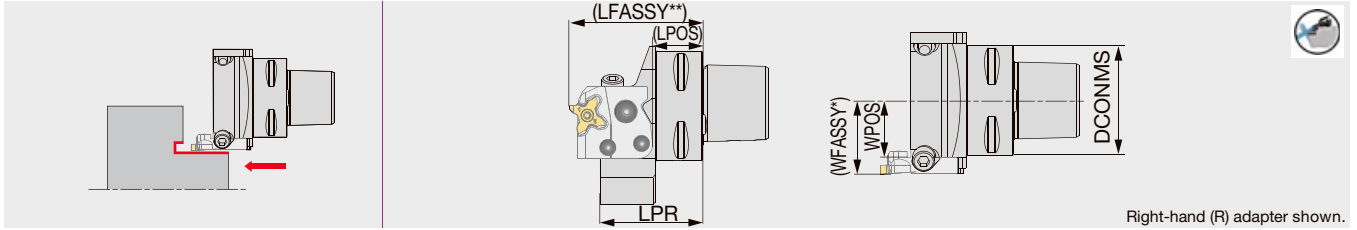

Right-hand (R) adapter shown.

Designation	DCONMS	LPR	LPOS	WPOS	Adapter (Option)	Torque*
C3CHSN19045-CHP	32	45	17.5	18.5	STCAR/L18-CHP	6.5
C4CHSN21047-CHP	40	46.5	21.5	21	STCAR/L18-CHP	6.5
C5CHSN26047-CHP	50	47	22.5	26	STCAR/L18-CHP	6.5
C6CHSN33050-CHP	63	50	24.5	32.5	STCAR/L18-CHP	6.5

WFASSY* : Toolholder (WPOS) + adapter (WF)

LFASSY** : Toolholder (LPOS) + adapter (LF)

Depend on the adapter type, the value of LFASSY or WFASSY may change.

Torque*: Recommended clamping torque (N·m)

Applicable for 30 MPa coolant

Please see page L053 for instructions on installing and removing the adapter or the insert.

C*CHFVN-CHP

Direct connection

Toolholder with TungCap connection, for perpendicularly-mounted adapter, with high pressure coolant capability

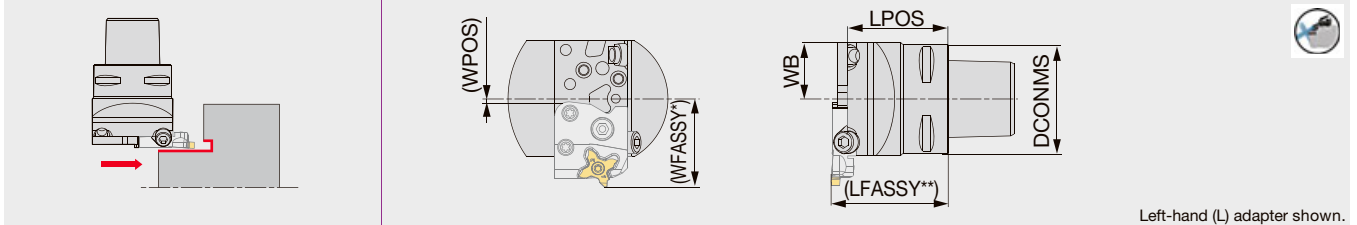

Left-hand (L) adapter shown.

Designation	DCONMS	LPOS	WB	WPOS	Adapter (Option)	Torque*
C3CHFVN26040-CHP	32	40	26	1.5	STCAR/L18-CHP	6.5
C4CHFVN26046-CHP	40	46	26	1.5	STCAR/L18-CHP	6.5
C5CHFVN26046-CHP	50	46	26	1.5	STCAR/L18-CHP	6.5
C6CHFVN33046-CHP	63	46	33	8.5	STCAR/L18-CHP	6.5

WFASSY* : Toolholder (WPOS) + adapter (LF)

LFASSY** : Toolholder (LPOS) + adapter (WF)

Depend on the adapter type, the value of LFASSY or WFASSY may change.

Torque*: Recommended clamping torque (N·m)

Applicable for 30 MPa coolant

Please see page L053 for instructions on installing and removing the adapter or the insert.

SPARE PARTS

Designation	Clamping screw 1	Wrench 1	Clamping screw 2	Clamping screw 3	Wrench 2	O-ring
C*CH**N*-CHP	SR M5-04451	T-20/5	SR M6X12DIN6912	SR M6X20-XT	HW5.0	OR 5X1N

Recommended clamping torque (N·m)

Clamping screw	Torque (N·m)
SR M5-04451	2.5
SR M6X12DIN6912	6.5
SR M6X20-XT	6.5

Reference pages: Inserts → F204 - F211, Adapters → F200, Standard cutting conditions → F212
 Technical Reference → L053

CHIPBREAKER GUIDE

Face grooving

TCF18 (4 corners)



First choice for face grooving

Provides light cutting action and excellent surface finish. Provides superior chip evacuation for face grooving operations.
 CW = 0.5 - 2.5 mm
 CDX = 3 mm



F205

External

External grooving

TCS18 (4 corners)



First choice for O.D. grooving

General-purpose pressed-in 3D chipbreaker for smooth chip control
 CW = 1 - 3 mm
 CDX = 3 mm



F205, F206

Face

Parting

Others

TCL18 (4 corners)



For lighter cutting action

Features pressed-in 3D chipbreaker with sharp cutting edge for light cutting action. Provides excellent chip control at low feed rates.
 CW = 1.5 - 3 mm
 CDX = 3 mm



F207

TCG18 (4 corners)



For better chipping resistance

Features an optimum rake angle and edge preparation for a good balance of light cutting action and fracture resistance.
 CW = 1 - 3.18 mm
 CDX = 3 mm



F208, F209

TCP18 (4 corners)



For higher surface quality

Featuring a large rake angle, providing light cutting action and better surface finish. TCP-F style insert is also available for sharp cutting edge.
 CW = 0.33 - 3 mm
 CDX = 3 mm



F210, F211

Please see page F*** for the product details.

INSERTS

TCF18L (Face grooving, sharp edge)

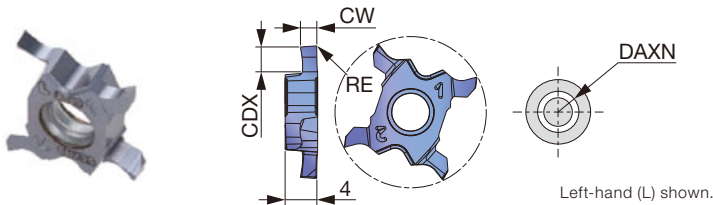

P Steel	★								
M Stainless	★								
K Cast iron	★								
N Non-ferrous									
S Superalloys	★								
H Hard materials									★ : First choice

Designation	HAND	CW±0.02	RE	Coated						CDX	DAXN	
				SH725								
TCF18L050F-005	L	0.5	0.05	●							1	6
TCF18L100F-005	L	1	0.05	●							2.5	6
TCF18L150F-005	L	1.5	0.05	●							2.5	6
TCF18L200F-005	L	2	0.05	●							3	6
TCF18L250F-005	L	2.5	0.05	●							3	6

5 pieces per package
● : Line up

TCS18R/L (3D chipbreaker, honed edge)

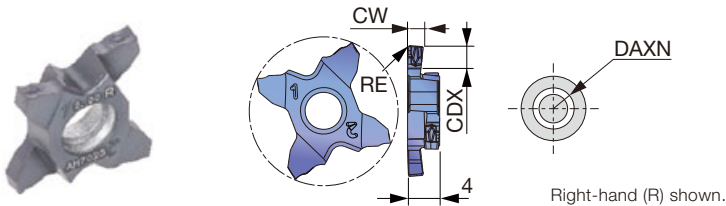

P Steel	★								
M Stainless	★								
K Cast iron	★								
N Non-ferrous									
S Superalloys	★								
H Hard materials									★ : First choice

Designation	HAND	CW±0.02	RE	Coated						CDX	DAXN	
				AH7025								
TCS18R100-010	R	1	0.1	●							2	65
TCS18L100-010	L	1	0.1	●							2	65
TCS18R120-010	R	1.2	0.1	●							2	65
TCS18L120-010	L	1.2	0.1	●							2	65
TCS18R125-010	R	1.25	0.1	●							2	65
TCS18L125-010	L	1.25	0.1	●							2	65
TCS18R125-020	R	1.25	0.2	●							2	65
TCS18L125-020	L	1.25	0.2	●							2	65
TCS18R130-020	R	1.3	0.2	●							3	65
TCS18L130-020	L	1.3	0.2	●							3	65
TCS18R140-010	R	1.4	0.1	●							3	65
TCS18L140-010	L	1.4	0.1	●							3	65
TCS18R140-020	R	1.4	0.2	●							3	65
TCS18L140-020	L	1.4	0.2	●							3	65
TCS18R145-010	R	1.45	0.1	●							3	65
TCS18L145-010	L	1.45	0.1	●							3	65

5 pieces per package
● : Line up

Reference pages: Toolholders → **F199 - F203**, Standard cutting conditions → **F212**

P	Steel	★							
M	Stainless	★							
K	Cast iron	★							
N	Non-ferrous								
S	Superalloys	★							
H	Hard materials								

★ : First choice

Designation	HAND	CW±0.02	RE	Coated							CDX	DAXN	
				AH7025									
TCS18R150-010	R	1.5	0.1	●								3	65
TCS18L150-010	L	1.5	0.1	●								3	65
TCS18R150-020	R	1.5	0.2	●								3	65
TCS18L150-020	L	1.5	0.2	●								3	65
TCS18R160-020	R	1.6	0.2	●								3	65
TCS18L160-020	L	1.6	0.2	●								3	65
TCS18R170-020	R	1.7	0.2	●								3	65
TCS18L170-020	L	1.7	0.2	●								3	65
TCS18R175-010	R	1.75	0.1	●								3	65
TCS18L175-010	L	1.75	0.1	●								3	65
TCS18R175-020	R	1.75	0.2	●								3	65
TCS18L175-020	L	1.75	0.2	●								3	65
TCS18R185-020	R	1.85	0.2	●								3	65
TCS18L185-020	L	1.85	0.2	●								3	65
TCS18R195-020	R	1.95	0.2	●								3	65
TCS18L195-020	L	1.95	0.2	●								3	65
TCS18R200-010	R	2	0.1	●								3	65
TCS18L200-010	L	2	0.1	●								3	65
TCS18R200-020	R	2	0.2	●								3	65
TCS18L200-020	L	2	0.2	●								3	65
TCS18R225-020	R	2.25	0.2	●								3	65
TCS18L225-020	L	2.25	0.2	●								3	65
TCS18R230-020	R	2.3	0.2	●								3	65
TCS18L230-020	L	2.3	0.2	●								3	65
TCS18R250-010	R	2.5	0.1	●								3	65
TCS18L250-010	L	2.5	0.1	●								3	65
TCS18R250-020	R	2.5	0.2	●								3	65
TCS18L250-020	L	2.5	0.2	●								3	65
TCS18R250-030	R	2.5	0.3	●								3	65
TCS18L250-030	L	2.5	0.3	●								3	65
TCS18R265-030	R	2.65	0.3	●								3	65
TCS18L265-030	L	2.65	0.3	●								3	65
TCS18R280-030	R	2.8	0.3	●								3	65
TCS18L280-030	L	2.8	0.3	●								3	65
TCS18R300-010	R	3	0.1	●								3	65
TCS18L300-010	L	3	0.1	●								3	65
TCS18R300-020	R	3	0.2	●								3	65
TCS18L300-020	L	3	0.2	●								3	65
TCS18R300-030	R	3	0.3	●								3	65
TCS18L300-030	L	3	0.3	●								3	65

5 pieces per package

● : Line up

Reference pages: Toolholders → **F199 - F203**, Standard cutting conditions → **F212**

TCL18R/L (3D chipbreaker, honed edge)

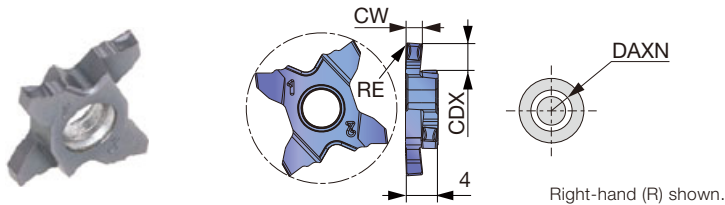

P	Steel	★							
M	Stainless	★							
K	Cast iron	★							
N	Non-ferrous								
S	Superalloys	★							
H	Hard materials								★ : First choice

Designation	HAND	CW±0.02	RE	Coated						CDX	DAXN
				AH7025							
TCL18R150-010	R	1.5	0.1	●						3	65
TCL18L150-010	L	1.5	0.1	●						3	65
TCL18R150-020	R	1.5	0.2	●						3	65
TCL18L150-020	L	1.5	0.2	●						3	65
TCL18R175-020	R	1.75	0.2	●						3	65
TCL18L175-020	L	1.75	0.2	●						3	65
TCL18R200-010	R	2	0.1	●						3	65
TCL18L200-010	L	2	0.1	●						3	65
TCL18R200-020	R	2	0.2	●						3	65
TCL18L200-020	L	2	0.2	●						3	65
TCL18R250-030	R	2.5	0.3	●						3	65
TCL18L250-030	L	2.5	0.3	●						3	65
TCL18R300-010	R	3	0.1	●						3	65
TCL18L300-010	L	3	0.1	●						3	65
TCL18R300-020	R	3	0.2	●						3	65
TCL18L300-020	L	3	0.2	●						3	65
TCL18R300-030	R	3	0.3	●						3	65
TCL18L300-030	L	3	0.3	●						3	65

5 pieces per package
● : Line up

TCG18R/L (honed edge)

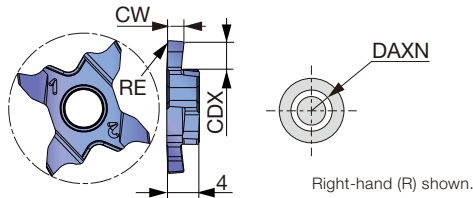

P	Steel	★
M	Stainless	★
K	Cast iron	★
N	Non-ferrous	
S	Superalloys	★
H	Hard materials	

★ : First choice



Designation	HAND	CW±0.02	RE	Coated										CDX	DAXN			
				AH7025														
TCG18R100-010	R	1	0.1	●													2	65
TCG18L100-010	L	1	0.1	●													2	65
TCG18R120-010	R	1.2	0.1	●													2	65
TCG18L120-010	L	1.2	0.1	●													2	65
TCG18R125-010	R	1.25	0.1	●													2	65
TCG18L125-010	L	1.25	0.1	●													2	65
TCG18R125-020	R	1.25	0.2	●													2	65
TCG18L125-020	L	1.25	0.2	●													2	65
TCG18R130-020	R	1.3	0.2	●													2	65
TCG18L130-020	L	1.3	0.2	●													2	65
TCG18R140-010	R	1.4	0.1	●													3	65
TCG18L140-010	L	1.4	0.1	●													3	65
TCG18R140-020	R	1.4	0.2	●													3	65
TCG18L140-020	L	1.4	0.2	●													3	65
TCG18R145-010	R	1.45	0.1	●													3	65
TCG18L145-010	L	1.45	0.1	●													3	65
TCG18R145-020	R	1.45	0.2	●													3	65
TCG18L145-020	L	1.45	0.2	●													3	65
TCG18R150-010	R	1.5	0.1	●													3	65
TCG18L150-010	L	1.5	0.1	●													3	65
TCG18R150-020	R	1.5	0.2	●													3	65
TCG18L150-020	L	1.5	0.2	●													3	65
TCG18R160-020	R	1.6	0.2	●													3	65
TCG18L160-020	L	1.6	0.2	●													3	65
TCG18R170-020	R	1.7	0.2	●													3	65
TCG18L170-020	L	1.7	0.2	●													3	65
TCG18R175-010	R	1.75	0.1	●													3	65
TCG18L175-010	L	1.75	0.1	●													3	65
TCG18R175-020	R	1.75	0.2	●													3	65
TCG18L175-020	L	1.75	0.2	●													3	65
TCG18R185-020	R	1.85	0.2	●													3	65
TCG18L185-020	L	1.85	0.2	●													3	65
TCG18R195-020	R	1.95	0.2	●													3	65
TCG18L195-020	L	1.95	0.2	●													3	65
TCG18R200-010	R	2	0.1	●													3	65
TCG18L200-010	L	2	0.1	●													3	65
TCG18R200-020	R	2	0.2	●													3	65
TCG18L200-020	L	2	0.2	●													3	65
TCG18R225-020	R	2.25	0.2	●													3	65
TCG18L225-020	L	2.25	0.2	●													3	65
TCG18R230-020	R	2.3	0.2	●													3	65
TCG18L230-020	L	2.3	0.2	●													3	65
TCG18R250-010	R	2.5	0.1	●													3	65
TCG18L250-010	L	2.5	0.1	●													3	65

5 pieces per package
● : Line up

Reference pages: Toolholders → **F199 - F203**, Standard cutting conditions → **F212**

P	Steel	★								
M	Stainless	★								
K	Cast iron	★								
N	Non-ferrous									
S	Superalloys	★								
H	Hard materials									

★ : First choice

Designation	HAND	CW±0.02	RE	Coated							CDX	DAXN
				AH7025								
TCG18R250-020	R	2.5	0.2	●							3	65
TCG18L250-020	L	2.5	0.2	●							3	65
TCG18R250-030	R	2.5	0.3	●							3	65
TCG18L250-030	L	2.5	0.3	●							3	65
TCG18R265-030	R	2.65	0.3	●							3	65
TCG18L265-030	L	2.65	0.3	●							3	65
TCG18R280-030	R	2.8	0.3	●							3	65
TCG18L280-030	L	2.8	0.3	●							3	65
TCG18R300-010	R	3	0.1	●							3	65
TCG18L300-010	L	3	0.1	●							3	65
TCG18R300-020	R	3	0.2	●							3	65
TCG18L300-020	L	3	0.2	●							3	65
TCG18R300-030	R	3	0.3	●							3	65
TCG18L300-030	L	3	0.3	●							3	65

5 pieces per package

● : Line up

TCG18R/L (Full R, honed edge)

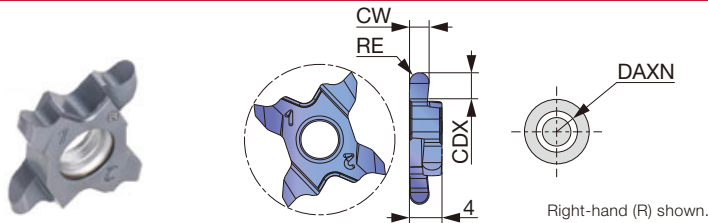

Right-hand (R) shown.

P	Steel	★								
M	Stainless	★								
K	Cast iron	★								
N	Non-ferrous									
S	Superalloys	★								
H	Hard materials									

★ : First choice

Designation	HAND	CW±0.02	RE	Coated							CDX	DAXN
				AH7025								
TCG18R100-050	R	1	0.5	●							2	65
TCG18L100-050	L	1	0.5	●							2	65
TCG18R158-079	R	1.58	0.79	●							3	65
TCG18L158-079	L	1.58	0.79	●							3	65
TCG18R200-100	R	2	1	●							3	65
TCG18L200-100	L	2	1	●							3	65
TCG18R239-120	R	2.39	1.2	●							3	65
TCG18L239-120	L	2.39	1.2	●							3	65
TCG18R300-150	R	3	1.5	●							3	65
TCG18L300-150	L	3	1.5	●							3	65
TCG18R318-159	R	3.18	1.59	●							3	65
TCG18L318-159	L	3.18	1.59	●							3	65

5 pieces per package

● : Line up

Reference pages: Toolholders → **F199 - F203**, Standard cutting conditions → **F212**



TCP18R/L (lightly honed edge)

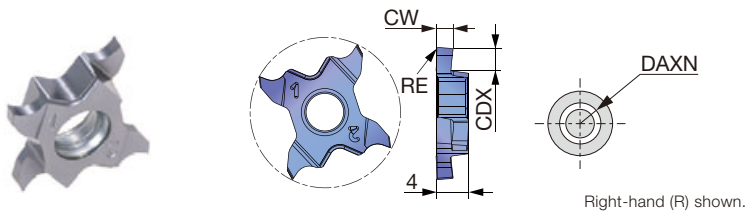

P	Steel	★
M	Stainless	★
K	Cast iron	★
N	Non-ferrous	
S	Superalloys	★
H	Hard materials	

★ : First choice



Designation	HAND	CW±0.02	RE	Coated							CDX	DAXN	
				AH725									
TCP18R033-005	R	0.33	0.05	●								0.8	65
TCP18L033-005	L	0.33	0.05	●								0.8	65
TCP18R043-005	R	0.43	0.05	●								1.2	65
TCP18L043-005	L	0.43	0.05	●								1.2	65
TCP18R050-005	R	0.5	0.05	●								1.2	65
TCP18L050-005	L	0.5	0.05	●								1.2	65
TCP18R075-005	R	0.75	0.05	●								2	65
TCP18L075-005	L	0.75	0.05	●								2	65
TCP18R095-005	R	0.95	0.05	●								2	65
TCP18L095-005	L	0.95	0.05	●								2	65
TCP18R100-010	R	1	0.1	●								2	65
TCP18L100-010	L	1	0.1	●								2	65
TCP18R120-010	R	1.2	0.1	●								2	65
TCP18L120-010	L	1.2	0.1	●								2	65
TCP18R125-010	R	1.25	0.1	●								2	65
TCP18L125-010	L	1.25	0.1	●								2	65
TCP18R140-010-35	R	1.4	0.1	●								3	65
TCP18L140-010-35	L	1.4	0.1	●								3	65
TCP18R145-010	R	1.45	0.1	●								2	65
TCP18L145-010	L	1.45	0.1	●								2	65
TCP18R145-010-35	R	1.45	0.1	●								3	65
TCP18L145-010-35	L	1.45	0.1	●								3	65
TCP18R150-010	R	1.5	0.1	●								2	65
TCP18L150-010	L	1.5	0.1	●								2	65
TCP18R150-010-35	R	1.5	0.1	●								3	65
TCP18L150-010-35	L	1.5	0.1	●								3	65
TCP18R175-010	R	1.75	0.1	●								2	65
TCP18L175-010	L	1.75	0.1	●								2	65
TCP18R175-010-35	R	1.75	0.1	●								3	65
TCP18L175-010-35	L	1.75	0.1	●								3	65
TCP18R200-010	R	2	0.1	●								2.5	65
TCP18L200-010	L	2	0.1	●								2.5	65
TCP18R200-010-35	R	2	0.1	●								3	65
TCP18L200-010-35	L	2	0.1	●								3	65
TCP18R250-010	R	2.5	0.1	●								2.5	65
TCP18L250-010	L	2.5	0.1	●								2.5	65
TCP18R250-010-35	R	2.5	0.1	●								3	65
TCP18L250-010-35	L	2.5	0.1	●								3	65
TCP18R300-010	R	3	0.1	●								2.5	65
TCP18L300-010	L	3	0.1	●								2.5	65
TCP18R300-010-35	R	3	0.1	●								3	65
TCP18L300-010-35	L	3	0.1	●								3	65

5 pieces per package

● : Line up

Reference pages: Toolholders → **F199 - F203**, Standard cutting conditions → **F212**

TCP18R/L-F (sharp edge)

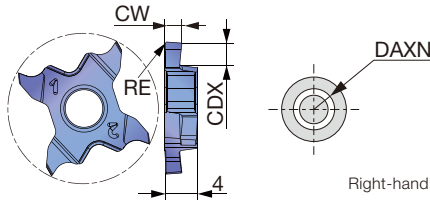

P	Steel	★
M	Stainless	★
K	Cast iron	★
N	Non-ferrous	
S	Superalloys	★
H	Hard materials	

★ : First choice

Designation	HAND	CW±0.02	RE	Coated										CDX	DAXN		
				SH725													
TCP18R033F-005	R	0.33	0.05	●												0.8	65
TCP18L033F-005	L	0.33	0.05	●												0.8	65
TCP18R043F-005	R	0.43	0.05	●												1.2	65
TCP18L043F-005	L	0.43	0.05	●												1.2	65
TCP18R050F-005	R	0.5	0.05	●												1.2	65
TCP18L050F-005	L	0.5	0.05	●												1.2	65
TCP18R075F-005	R	0.75	0.05	●												2	65
TCP18L075F-005	L	0.75	0.05	●												2	65
TCP18R095F-005	R	0.95	0.05	●												2	65
TCP18L095F-005	L	0.95	0.05	●												2	65
TCP18R100F-005	R	1	0.05	●												2	65
TCP18R100F-010	R	1	0.1	●												2	65
TCP18L100F-010	L	1	0.1	●												2	65
TCP18R120F-005	R	1.2	0.05	●												2	65
TCP18R120F-010	R	1.2	0.1	●												2	65
TCP18L120F-010	L	1.2	0.1	●												2	65
TCP18R125F-005	R	1.25	0.05	●												2	65
TCP18R125F-010	R	1.25	0.1	●												2	65
TCP18L125F-010	L	1.25	0.1	●												2	65
TCP18R140F-010-35	R	1.4	0.1	●												3	65
TCP18R145F-005-35	R	1.45	0.05	●												3	65
TCP18R145F-010	R	1.45	0.1	●												2	65
TCP18L145F-010	L	1.45	0.1	●												2	65
TCP18R145F-010-35	R	1.45	0.1	●												3	65
TCP18L145F-010-35	L	1.45	0.1	●												3	65
TCP18R150F-005-35	R	1.5	0.05	●												3	65
TCP18R150F-010	R	1.5	0.1	●												2	65
TCP18L150F-010	L	1.5	0.1	●												2	65
TCP18R150F-010-35	R	1.5	0.1	●												3	65
TCP18L150F-010-35	L	1.5	0.1	●												3	65
TCP18R175F-005-35	R	1.75	0.05	●												3	65
TCP18R175F-010	R	1.75	0.1	●												2	65
TCP18L175F-010	L	1.75	0.1	●												2	65
TCP18R175F-010-35	R	1.75	0.1	●												3	65
TCP18L175F-010-35	L	1.75	0.1	●												3	65
TCP18R200F-005-35	R	2	0.05	●												3	65
TCP18R200F-010	R	2	0.1	●												2.5	65
TCP18L200F-010	L	2	0.1	●												2.5	65
TCP18R200F-010-35	R	2	0.1	●												3	65
TCP18L200F-010-35	L	2	0.1	●												3	65
TCP18R250F-010	R	2.5	0.1	●												2.5	65
TCP18L250F-010	L	2.5	0.1	●												2.5	65
TCP18R250F-010-35	R	2.5	0.1	●												3	65
TCP18L250F-010-35	L	2.5	0.1	●												3	65
TCP18R300F-010	R	3	0.1	●												2.5	65
TCP18L300F-010	L	3	0.1	●												2.5	65
TCP18R300F-010-35	R	3	0.1	●												3	65
TCP18L300F-010-35	L	3	0.1	●												3	65

5 pieces per package
● : Line up

Reference pages: Toolholders → **F199 - F203**, Standard cutting conditions → **F212**

STANDARD CUTTING CONDITIONS

TCF18L (Face grooving)

ISO	Workpiece materials	Grades	Cutting speed Vc (m/min)	Feed f (mm/rev)
P	Low carbon steel S15C, C15E, C15E4, S20C, C20, etc.	SH725	30 - 100	0.01 - 0.04
	Carbon steels, Alloy steel S55C, C55, SCM440, 42CrMoS4, etc.	SH725	30 - 100	0.01 - 0.04
	Prehardened steel NAK80, PX5, etc.	SH725	30 - 100	0.01 - 0.04
M	Stainless steel SUS304, X5CrNi18-9, X5CrNiMo17-12-2, etc.	SH725	30 - 100	0.01 - 0.04
K	Grey cast iron FC250, GG25, 250, FC300, GG30, 300, etc.	SH725	30 - 100	0.01 - 0.04
	Ductile cast iron FCD400, 400-15, FCD600, GGG60, 600-3, etc.	SH725	30 - 100	0.01 - 0.04
S	Titanium alloys Ti-6Al-4V, etc.	SH725	20 - 40	0.01 - 0.04
	Superalloys Inconel718, etc.	SH725	10 - 30	0.01 - 0.04

TCS18R/L, TCL18R/L (3D chipbreaker), TCG18R/L (honed edge), TCG18R/L (Full R)

ISO	Workpiece materials	Grade	Cutting speed Vc (m/min)	Feed: f (mm/rev)		
				TCL18	TCS18	TCG18
P	Low carbon steel S15C, SS400, etc., C15E4, E275A, etc.	AH7025	80 - 180	0.03 - 0.12	0.04 - 0.16	0.04 - 0.14
	Carbon steel, Alloy steel S55C, SCM440, etc., C55, 42CrMo4, etc.	AH7025	80 - 180	0.03 - 0.12	0.04 - 0.16	0.04 - 0.14
	Prehardened steel NAK80, PX5, etc.	AH7025	80 - 180	0.03 - 0.12	0.04 - 0.16	0.04 - 0.14
M	Stainless steel SUS304, SUS316, etc., X5CrNi18-9, X5CrNiMo17-12-3, etc.	AH7025	50 - 120	0.03 - 0.12	0.04 - 0.16	0.04 - 0.14
K	Grey cast iron FC250, FC300, etc., 250, 300, etc., GG25, GG30, etc.	AH7025	50 - 180	0.03 - 0.12	0.04 - 0.16	0.04 - 0.14
	Ductile cast iron FCD400, etc., 400-15S, etc., GGG40, etc.	AH7025	50 - 180	0.03 - 0.12	0.04 - 0.16	0.04 - 0.14
S	Titanium alloys Ti-6Al-4V, etc.	AH7025	30 - 60	0.03 - 0.12	0.04 - 0.16	0.04 - 0.14
	Superalloys Inconel718, etc.	AH7025	20 - 40	0.03 - 0.12	0.04 - 0.16	0.04 - 0.14

TCP18R/L (lightly honed edge), TCP18R/L-F (sharp edge)

ISO	Workpiece materials	Priority	Grades	Cutting speed Vc (m/min)	Feed f (mm/rev)
P	Low carbon steel S15C, SS400, etc., C15E4, E275A, etc.	First choice	SH725	80 - 180	0.03 - 0.1
		Toughness	AH725	80 - 180	0.03 - 0.1
	Carbon steel, Alloy steel S55C, SCM440, etc., C55, 42CrMo4, etc.	First choice	SH725	80 - 180	0.03 - 0.1
		Toughness	AH725	80 - 180	0.03 - 0.1
	Prehardened steel NAK80, PX5, etc.	First choice	SH725	80 - 180	0.03 - 0.1
		Toughness	AH725	80 - 180	0.03 - 0.1
M	Stainless steel SUS304, SUS316, etc., X5CrNi18-9, X5CrNiMo17-12-3, etc.	First choice	SH725	50 - 120	0.03 - 0.1
		Toughness	AH725	50 - 120	0.03 - 0.1
K	Grey cast iron FC250, FC300, etc., 250, 300, etc., GG25, GG30, etc.	First choice	AH725	50 - 180	0.03 - 0.1
		Sharpness	SH725	50 - 180	0.03 - 0.1
	Ductile cast iron FCD400, etc., 400-15S, etc., GGG40, etc.	First choice	AH725	50 - 180	0.03 - 0.1
		Sharpness	SH725	50 - 180	0.03 - 0.1
S	Titanium alloys Ti-6Al-4V, etc.	First choice	SH725	30 - 80	0.03 - 0.1
		Toughness	AH725	30 - 80	0.03 - 0.1
	Superalloys Inconel718, etc.	First choice	AH725	20 - 40	0.03 - 0.1

Precautions of processing

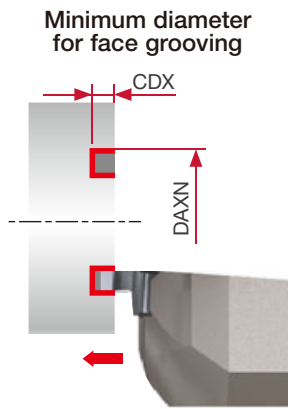

Minimum face diameter DAXN (mm)	Maximum groove depth CDX (mm)
65	3

Grade

A

Insert

B

Ext. Toolholder

C

Int. Toolholder

D

Threading

E

Grooving

F

Miniature tool

G

Milling cutter

H

Endmill

I

Drilling tool

J

Tooling System

K

User's Guide

L

Index

M

MY-T SERIES

#S/D##R/L+CGWSR/L

Adapter for face grooving and turning toolholders (CGWSR/L-#S/D, CGWTR/L-#S/D)

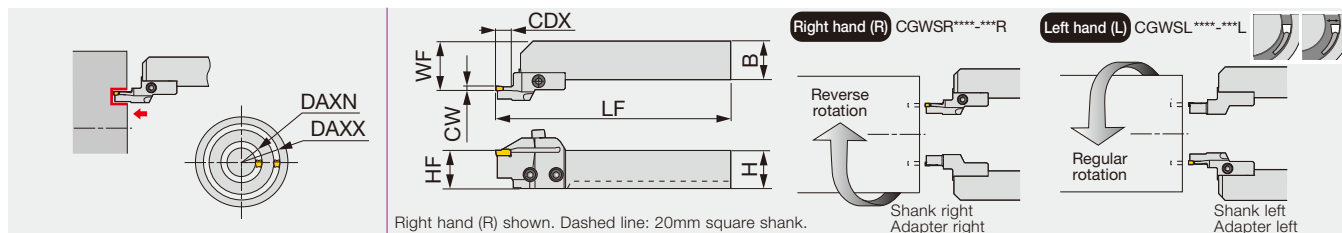

Right hand (R) shown. Dashed line: 20mm square shank.

Designation	CW	DAXN	DAXX	CDX	H	B	LF	HF	WF	Insert	Shank	Torque*
30S3040R/L	3	30	40	10	20/25	20/25	152.5	20/25	27/32	G*30, GE30-AL	CGWSR/L...	5
30S4050R/L	3	40	50	10	20/25	20/25	152.5	20/25	27/32	G*30, GE30-AL	CGWSR/L...	5
30S5065R/L	3	50	65	10	20/25	20/25	152.5	20/25	27/32	G*30, GE30-AL	CGWSR/L...	5
30S6590R/L	3	65	90	10	20/25	20/25	152.5	20/25	27/32	G*30, GE30-AL	CGWSR/L...	5
30S90150R/L	3	90	150	10	20/25	20/25	152.5	20/25	27/32	G*30, GE30-AL	CGWSR/L...	5
30S150500R/L	3	150	500	10	20/25	20/25	152.5	20/25	27/32	G*30, GE30-AL	CGWSR/L...	5
40S3545R/L	4	35	45	14	20/25	20/25	152.5	20/25	27/32	G*40, GE40-AL	CGWSR/L...	5
40S4555R/L	4	45	55	14	20/25	20/25	152.5	20/25	27/32	G*40, GE40-AL	CGWSR/L...	5
40S5580R/L	4	55	80	14	20/25	20/25	152.5	20/25	27/32	G*40, GE40-AL	CGWSR/L...	5
40S80140R/L	4	80	140	14	20/25	20/25	152.5	20/25	27/32	G*40, GE40-AL	CGWSR/L...	5
40S140500R/L	4	140	500	14	20/25	20/25	152.5	20/25	27/32	G*40, GE40-AL	CGWSR/L...	5
40D3545R/L	4	35	45	22	20/25	20/25	160.5	20/25	27/32	G*40, GE40-AL	CGWSR/L...	5
40D4555R/L	4	45	55	22	20/25	20/25	160.5	20/25	27/32	G*40, GE40-AL	CGWSR/L...	5
40D5580R/L	4	55	80	22	20/25	20/25	160.5	20/25	27/32	G*40, GE40-AL	CGWSR/L...	5
40D80140R/L	4	80	140	22	20/25	20/25	160.5	20/25	27/32	G*40, GE40-AL	CGWSR/L...	5
40D140500R/L	4	140	500	22	20/25	20/25	160.5	20/25	27/32	G*40, GE40-AL	CGWSR/L...	5
50S3545R/L	5	35	45	14	20/25	20/25	152.5	20/25	27/32	G*50	CGWSR/L...	5
50S4555R/L	5	45	55	14	20/25	20/25	152.5	20/25	27/32	G*50	CGWSR/L...	5
50S5575R/L	5	55	75	14	20/25	20/25	152.5	20/25	27/32	G*50	CGWSR/L...	5
50S75130R/L	5	75	130	14	20/25	20/25	152.5	20/25	27/32	G*50	CGWSR/L...	5
50S130500R/L	5	130	500	14	20/25	20/25	152.5	20/25	27/32	G*50	CGWSR/L...	5
50D3545R/L	5	35	45	22	20/25	20/25	160.5	20/25	27/32	G*50	CGWSR/L...	5
50D4555R/L	5	45	55	22	20/25	20/25	160.5	20/25	27/32	G*50	CGWSR/L...	5
50D5575R/L	5	55	75	22	20/25	20/25	160.5	20/25	27/32	G*50	CGWSR/L...	5
50D75130R/L	5	75	130	22	20/25	20/25	160.5	20/25	27/32	G*50	CGWSR/L...	5
50D130500R/L	5	130	500	22	20/25	20/25	160.5	20/25	27/32	G*50	CGWSR/L...	5

Toolholders are in stock with the designations of: a set of shank and adapter; a shank; a adapter. Combining the designations of a adapter and a shank will make the designation of a set. Please check the stock and place an order with the designation of a set or a shank+a adapter. Use right-hand shanks (CGWSR~) with right-hand adapters (~R); and left-hand shanks (CGWSL~) with left-hand adapters (~L). Torque*: Recommended clamping torque (N·m)

SPARE PARTS

Designation	Clamping screw	Adapter screw	Wrench
30S..., 40S...	CHHM5-18	CSHB-6	P-4
40D...	CM5X0.8X16	CSHB-6	P-4
50S...	CHHM5-18	CSHB-6	P-4
50D...	CM5X0.8X16	CSHB-6	P-4

Combination of adapter and shank

Shank	Adapter	
	S/DR	**S/D**L
CGWSR...	●	
CGWSL...		●
CGWTR...		●
CGWTL...	●	

● : Corresponding

Reference pages: Inserts → **F217 - F220**, Shanks → **F216**, Standard cutting conditions → **F221**

#S/D##R/L+CGWTR/L

Adapter for face grooving and turning toolholders (CGWSR/L-#S/D, CGWTR/L-#S/D)

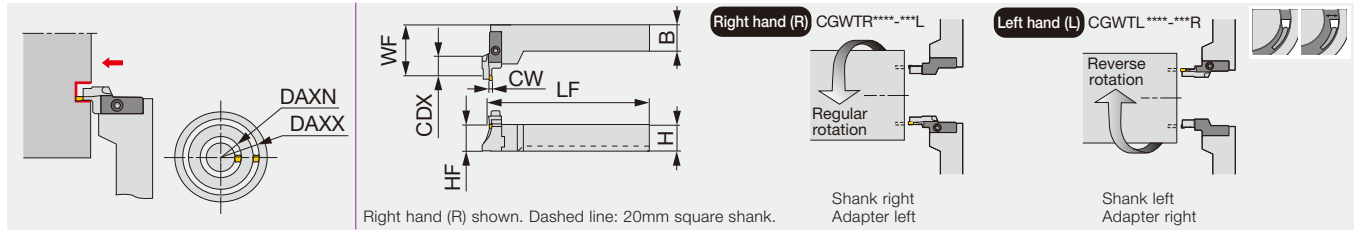

Designation	CW	DAXN	DAXX	CDX	H	B	LF	HF	WF	Insert	Shank	Torque*
30S3040R/L	3	30	40	10	20/25	20/25	150	20/25	52.25	G*30, GE30-AL	CGWTL/R...	5
30S4050R/L	3	40	50	10	20/25	20/25	150	20/25	52.25	G*30, GE30-AL	CGWTL/R...	5
30S5065R/L	3	50	65	10	20/25	20/25	150	20/25	52.25	G*30, GE30-AL	CGWTL/R...	5
30S6590R/L	3	65	90	10	20/25	20/25	150	20/25	52.25	G*30, GE30-AL	CGWTL/R...	5
30S90150R/L	3	90	150	10	20/25	20/25	150	20/25	52.25	G*30, GE30-AL	CGWTL/R...	5
30S150500R/L	3	150	500	10	20/25	20/25	150	20/25	52.25	G*30, GE30-AL	CGWTL/R...	5
40S3545R/L	4	35	45	14	20/25	20/25	150	20/25	52.25	G*40, GE40-AL	CGWTL/R...	5
40S4555R/L	4	45	55	14	20/25	20/25	150	20/25	52.25	G*40, GE40-AL	CGWTL/R...	5
40S5580R/L	4	55	80	14	20/25	20/25	150	20/25	52.25	G*40, GE40-AL	CGWTL/R...	5
40S80140R/L	4	80	140	14	20/25	20/25	150	20/25	52.25	G*40, GE40-AL	CGWTL/R...	5
40S140500R/L	4	140	500	14	20/25	20/25	150	20/25	52.25	G*40, GE40-AL	CGWTL/R...	5
40D3545R/L	4	35	45	22	20/25	20/25	150	20/25	60.25	G*40, GE40-AL	CGWTL/R...	5
40D4555R/L	4	45	55	22	20/25	20/25	150	20/25	60.25	G*40, GE40-AL	CGWTL/R...	5
40D5580R/L	4	55	80	22	20/25	20/25	150	20/25	60.25	G*40, GE40-AL	CGWTL/R...	5
40D80140R/L	4	80	140	22	20/25	20/25	150	20/25	60.25	G*40, GE40-AL	CGWTL/R...	5
40D140500R/L	4	140	500	22	20/25	20/25	150	20/25	60.25	G*40, GE40-AL	CGWTL/R...	5
50S3545R/L	5	35	45	14	20/25	20/25	150	20/25	52.25	G*50	CGWTL/R...	5
50S4555R/L	5	45	55	14	20/25	20/25	150	20/25	52.25	G*50	CGWTL/R...	5
50S5575R/L	5	55	75	14	20/25	20/25	150	20/25	52.25	G*50	CGWTL/R...	5
50S75130R/L	5	75	130	14	20/25	20/25	150	20/25	52.25	G*50	CGWTL/R...	5
50S130500R/L	5	130	500	14	20/25	20/25	150	20/25	52.25	G*50	CGWTL/R...	5
50D3545R/L	5	35	45	22	20/25	20/25	150	20/25	60.25	G*50	CGWTL/R...	5
50D4555R/L	5	45	55	22	20/25	20/25	150	20/25	60.25	G*50	CGWTL/R...	5
50D5575R/L	5	55	75	22	20/25	20/25	150	20/25	60.25	G*50	CGWTL/R...	5
50D75130R/L	5	75	130	22	20/25	20/25	150	20/25	60.25	G*50	CGWTL/R...	5
50D130500R/L	5	130	500	22	20/25	20/25	150	20/25	60.25	G*50	CGWTL/R...	5

Toolholders are in stock with the designations of: a set of shank and adapter; a shank; a adapter. Combining the designations of a adapter and a shank will make the designation of a set. Please check the stock and place an order with the designation of a set or a shank+a adapter. Use right-hand shanks (CGWTR~) with left-hand adapters (~L); and left-hand shanks (CGWTL~) with right-hand adapters (~R). Torque*: Recommended clamping torque (N·m)

SPARE PARTS			
Designation	Clamping screw	Adapter screw	Wrench
30S..., 40S...	CHHM5-18	CSHB-6	P-4
40D...	CM5X0.8X16	CSHB-6	P-4
50S...	CHHM5-18	CSHB-6	P-4
50D...	CM5X0.8X16	CSHB-6	P-4

Combination of adapter and shank

Shank	Adapter	
	S/DR	**S/D**L
CGWSR...	●	
CGWSL...		●
CGWTR...		●
CGWTL...	●	

● : Corresponding

Reference pages: Inserts → **F217 - F220**, Shanks → **F216**, Standard cutting conditions → **F221**



MY-T SERIES

CGWSR/L

Shank for CGWSR/L-WG, -WG-L, -G, -CGD, -FL-G/TP, and -#S/D toolholders

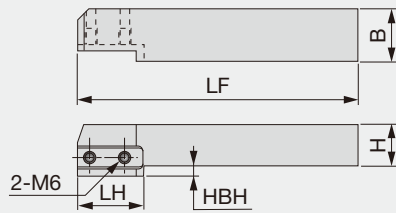

Right hand (R) shown.

Designation	H	B	LF	LH	HBH
CGWSR/L2020	20	20	137	32.5	5
CGWSR/L2525	25	25	137	-	-



CGWTR/L

Shank for CGWSR/L-WG, -WG-L, -G, -CGD, -FL-G/TP, and -#S/D toolholders, for tangentially clamped adapter

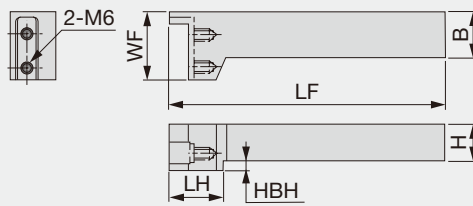

Right hand (R) shown.

Designation	H	B	LF	LH	WF	HBH
CGWTR/L2020	20	20	150	30.5	37	5
CGWTR/L2525	25	25	150	-	37	-



SPARE PARTS



Designation	Adapter screw
CGW*R/L...	CSHB-6

Reference pages: Inserts → [F217 - F220](#), Standard cutting conditions → [F221](#)

Face grooving

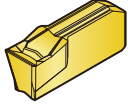
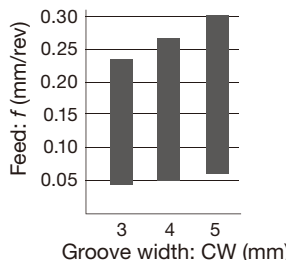
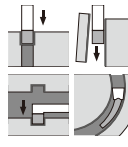
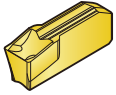
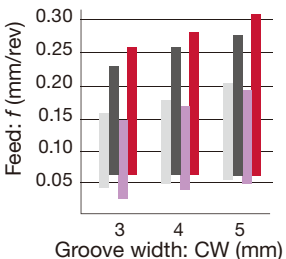
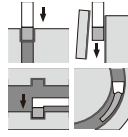
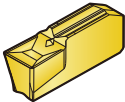
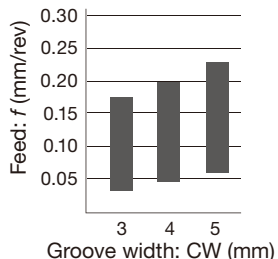
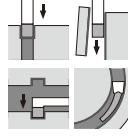
<p>GF</p>  <p>F219</p>	<p>1st choice for face grooving Low cutting force and good chip control for face grooving CW = 3 - 5 mm</p>	 <p>Legend: Face grooving</p> 
<p>GE</p>  <p>F218</p>	<p>1st choice for external grooving and parting Excellent chip control for grooving CW = 3 - 5 mm</p>	 <p>Legend: External grooving, Internal grooving, Face grooving, Parting</p> 
<p>GN</p>  <p>F220</p>	<p>1st choice for internal grooving Low cutting force and good chip control for internal grooving CW = 3 - 5 mm</p>	 <p>Legend: Face grooving</p> 

External grooving and turning

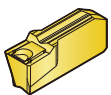
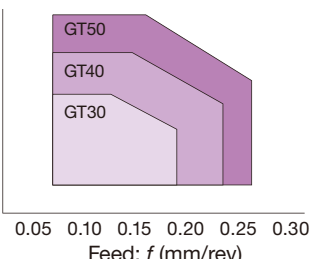
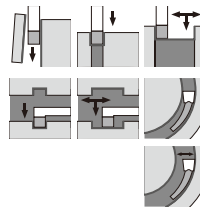
<p>GT</p>  <p>F218</p>	<p>1st choice for turning Low cutting force and good chip control for traversing CW = 3 - 5 mm</p>	 
---	--	--

For profiling

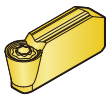
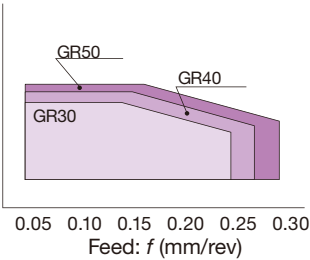
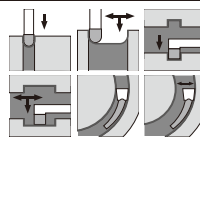
<p>GR</p>  <p>F219</p>	<p>Full radius type Low cutting force and good chip control for profiling CW = 3 - 5 mm</p>	 
---	---	--

Please see page F*** for the product details.

For aluminium and non-ferrous metal

GE-AL

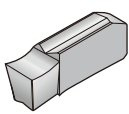

F220

Reduce cutting force and welding due to sharp chipbreaker

CW = 3 - 4 mm

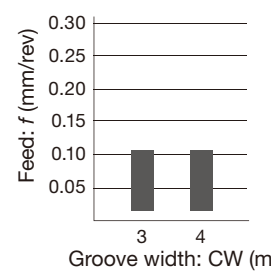

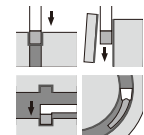

Please see page F*** for the product details.

INSERTS

GE

For external grooving and parting

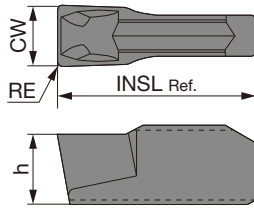

P Steel	★	★	★					★					
M Stainless		★	★										
K Cast iron		★	☆					☆					
N Non-ferrous													
S Superalloys			☆										
H Hard materials													

★ : First choice
☆ : Second choice

Designation	CW ^{+0.1} ₀	RE	Coated			Cermet			INSL	h
			T9225	AH120	GH730	NS9530				
GE30	3	0.2	●	●	●		●		10	3.5
GE40	4	0.2	●	●	●		●		10	4
GE50	5	0.2	●	●	●		●		12	4.5

● : Line up

GT

For external grooving and turning

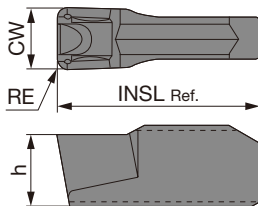

P Steel	★	★	★					★					
M Stainless		★	★										
K Cast iron		★	☆					☆					
N Non-ferrous													
S Superalloys			☆										
H Hard materials													

★ : First choice
☆ : Second choice

Designation	CW ^{+0.1} ₀	RE	Coated			Cermet			INSL	h
			T9225	AH120	GH730	NS9530				
GT30	3	0.4		●	●		●		10	3.5
GT40	4	0.4		●	●		●		10	4
GT50	5	0.4	●	●	●		●		12	4.5

● : Line up

Reference pages: Toolholders → **F214 - F216**, Standard cutting conditions → **F221**

GR

For profiling (full radius)

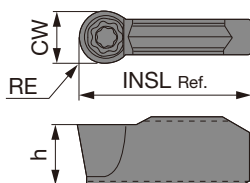

P	Steel	★	★	★				★				
M	Stainless		★	★								
K	Cast iron		★	☆				☆				
N	Non-ferrous											
S	Superalloys		☆									
H	Hard materials											

★ : First choice
☆ : Second choice

Designation	CW ₀ ^{+0.1}	RE	Coated			Cermet				INSL	h
			T9225	AH120	GH730	NS9530					
GR30	3	1.5	●	●	●	●				10	3.5
GR40	4	2	●	●	●	●				10	4
GR50	5	2.5	●	●	●	●				12	4.5

● : Line up

GF

For face grooving

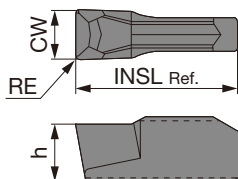

P	Steel	★		★								
M	Stainless	★										
K	Cast iron	☆		☆								
N	Non-ferrous											
S	Superalloys											
H	Hard materials											

★ : First choice
☆ : Second choice

Designation	CW ₀ ^{+0.1}	RE	Coated	Cermet						INSL	h
			GH730	NS9530							
GF30	3	0.2	●	●						10	3.5
GF40	4	0.2	●	●						10	4
GF50	5	0.2	●	●						12	4.5

● : Line up

GN

For internal grooving

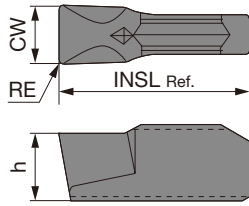

P	Steel	★									
M	Stainless	★									
K	Cast iron	☆									
N	Non-ferrous										
S	Superalloys										
H	Hard materials										

★ : First choice
☆ : Second choice

Designation	CW ^{+0.1} ₀	RE	Coated							INSL	h
			GH730								
GN30	3	0.2	●							10	3.5
GN40	4	0.2	●							10	4
GN50	5	0.2	●							12	4.5

● : Line up

GE-AL

For aluminium and non-ferrous metal

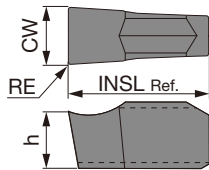

P	Steel										
M	Stainless										
K	Cast iron										
N	Non-ferrous	★									
S	Superalloys										
H	Hard materials										

★ : First choice
☆ : Second choice

Designation	CW ^{+0.1} ₀	RE	Uncoated							INSL	h
			KS05F								
GE30-AL	3	0.2	●							10	3.5
GE40-AL	4	0.2	●							10	4

● : Line up

Reference pages: Toolholders → **F214 - F216**, Standard cutting conditions → **F221**

STANDARD CUTTING CONDITIONS

ISO	Workpiece material	Grade	Cutting speed Vc (m/min)
P	Low carbon steel, Alloy steel (~ HB150)	T9225	80 - 300
		NS9530	100 - 200
		GH730, AH120	50 - 180
	Medium carbon steel, Alloy steel (HB150 ~ 250)	T9225	80 - 220
		NS9530	80 - 180
		GH730, AH120	50 - 150
	High carbon steel, Alloy steel (HB250 ~)	T9225	80 - 220
		NS9530	80 - 150
		GH730, AH120	50 - 120
M	Stainless steel	GH730, AH120	50 - 120
K	Grey iron, Ductile cast iron	GH730, AH120	50 - 180
N	Aluminium alloy, Non-ferrous metal	KS05F	200 - 300

For face grooving

Operation	Feed: f (mm/rev)		
	Groove width: CW (mm)		
	3	4	5
Face grooving (GE**)	0.06 - 0.22	0.06 - 0.24	0.07 - 0.26
Face grooving (GF**)	0.04 - 0.25	0.05 - 0.26	0.05 - 0.30
Traversing (GT**)	$ap = 0.5 - 1.5$ $f = 0.06 - 0.2$	$ap = 0.5 - 2$ $f = 0.06 - 0.25$	$ap = 0.5 - 2.5$ $f = 0.06 - 0.27$
Traversing (GR**)	$ap = 0.5 - 1.4$ $f = 0.05 - 0.25$	$ap = 0.5 - 1.5$ $f = 0.05 - 0.26$	$ap = 0.5 - 1.6$ $f = 0.05 - 0.3$
Grooving for Aluminium alloys (GE**-AL)	0.03 - 0.1	0.03 - 0.1	-

For diameter compensation values in traversing, [F115](#) page

When vibration occurs in turning, please use the lower limit value in the above table.

GX-R/LF

Face grooving toolholder

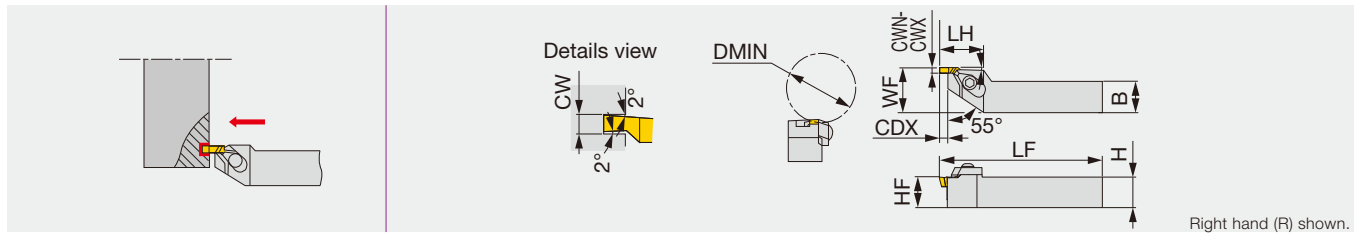

Designation	CWN	CWX	DMIN	CDX	H	B	LF	LH	HF	WF	Insert	Torque*
GX-2525R/LF	1	4.5	55	1.5 - 6	25	25	150	35	25	32	XNL/R63...	5

Use right-hand toolholders (GX-...RF) with left-hand inserts (XNL); and left-hand toolholders (GX-...LF) with right-hand inserts (XNR).
 Torque*: Recommended clamping torque (N·m)

SPARE PARTS						
Designation	Clamp set	Clamping screw	Shim	Shim screw	Wrench	
GX-2525RF	CP81A	RT-1	SL-3R	BHM4-8	P-4	
GX-2525LF	CP81A	RT-1	SL-3L	BHM4-8	P-4	

INSERT

XNR/L

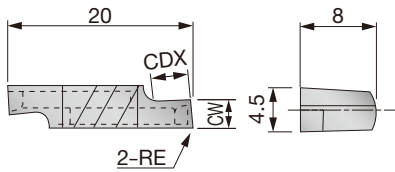

P	Steel	★		★						
M	Stainless									
K	Cast iron	☆		☆						
N	Non-ferrous									
S	Superalloys									
H	Hard materials									

★ : First choice
 ☆ : Second choice

Designation	HAND	CW±0.05	RE	Cermet		Uncoated				CDX
				NS9530	TH10					
XNR6310-02	R	1	0.2	●	●					1.5
XNL6310-02	L	1	0.2	●	●					1.5
XNR6315-02	R	1.5	0.2	●	●					2.3
XNL6315-02	L	1.5	0.2	●	●					2.3
XNR6320-02	R	2	0.2	●	●					3
XNL6320-02	L	2	0.2	●	●					3
XNR6325-02	R	2.5	0.2	●	●					3.8
XNL6325-02	L	2.5	0.2	●	●					3.8
XNR6330-02	R	3	0.2	●	●					4.5
XNL6330-02	L	3	0.2	●	●					4.5
XNR6335-02	R	3.5	0.2	●	●					5.3
XNL6335-02	L	3.5	0.2	●	●					5.3
XNR6340-02	R	4	0.2	●	●					6
XNL6340-02	L	4	0.2	●	●					6
XNR6345-02	R	4.5	0.2	●	●					6
XNL6345-02	L	4.5	0.2	●	●					6

● : Line up

STANDARD CUTTING CONDITIONS

ISO	Workpiece material	Grade	Cutting speed Vc (m/min)	Feed: f (mm/rev)		
				CW < 2 mm	CW = 2 ~ 4 mm	CW > 4 mm
P	Carbon steels	NS9530	80 - 200	0.05 - 0.1	0.08 - 0.2	0.08 - 0.25
K	Cast irons, Light alloys	TH10	60 - 150	0.05 - 0.1	0.08 - 0.2	0.08 - 0.25

MY-T SERIES

CGWSR/L-FLR/L5TP

Face grooving and turning toolholder

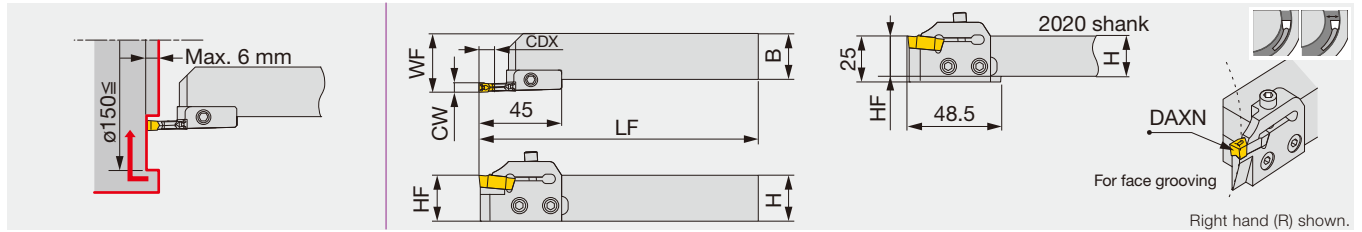

Designation	CW	DAXN	CDX	H	B	LF	HF	WF	Insert	Shank	Adapter	Torque*
CGWSR/L2020-FLR/L5TP	5	150	6	20	20	152	20	27	FLEX50R/L	CGWSR/L2020	FLR/L5TP	5
CGWSR/L2525-FLR/L5TP	5	150	6	25	25	152	25	32	FLEX50R/L	CGWSR/L2525	FLR/L5TP	5

Toolholders are in stock with the designations of: a set of shank and adapter; a shank; a adapter. Combining the designations of a adapter and a shank will make the designation of a set. Please check the stock and place an order with the designation of a set or a shank+a adapter.
 Note: Use right-hand shanks (CGWSR...) with right-hand adapters (FLR5TP); and left-hand shanks (CGWSL...) with left-hand adapters (FLR5LP).
 Torque*: Recommended clamping torque (N·m)

SPARE PARTS

Designation	Clamping screw	Adapter screw	Wrench
CGWSR/L****-FLR/L5TP	CHHM5-18	CSHB-6	P-4

INSERT

FLEX(R/L)

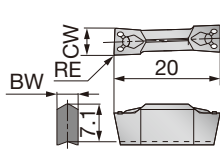

Right hand (R) shown.

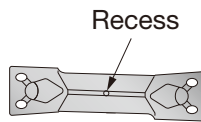

To distinguish the insert hands, the V-shape surface (top surface) of a left-hand insert has a recess. (not of a right-hand insert)

	P	M	K	N	S	H
Steel	★					
Stainless	★					
Cast iron	☆					
Non-ferrous						
Superalloys						
Hard materials						

★ : First choice
 ☆ : Second choice

Designation	HAND	CW±0.05	RE	Coated		Cermet		Uncoated		BW
				T9225		NS9530		UX30		
FLEX30R	R	3	0.4			●				2.2
FLEX30L	L	3	0.4			●				2.2
FLEX40R	R	4	0.4			●				3.1
FLEX40L	L	4	0.4			●				3.1
FLEX50R	R	5	0.4	●		●		●		4
FLEX50L	L	5	0.4	●		●		●		4

● : Line up

STANDARD CUTTING CONDITIONS

ISO	Workpiece material	Grade	Cutting speed Vc (m/min)	Feed: f (mm/rev)	
				Grooving	Turning
P	Carbon steels	T9225	80 - 300	0.05 - 0.25	0.1 - 0.3
		NS9530	80 - 200	0.05 - 0.25	0.1 - 0.3
		UX30	60 - 150	0.05 - 0.25	0.1 - 0.3

External toolholders for grooving and parting

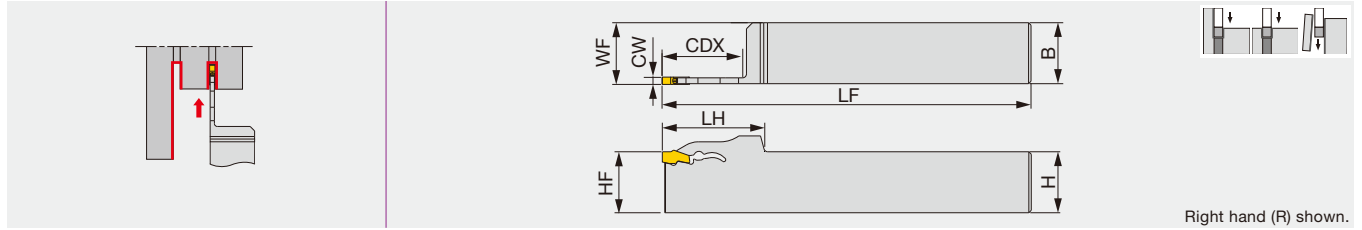

Designation	CW	CDX	Seat size	H	B	LF	LH	HF	WF
QSER/L2020-2T26	2	26	2	20	20	125	36	20	20.1
QSER/L2020-2T33	2	33	2	20	20	125	42	20	20.1
QSER/L2525-2T26	2	26	2	25	25	150	36	25	25.1
QSER/L2525-2T33	2	33	2	25	25	150	42	25	25.1
QSER/L2020-3T26	3	26	3	20	20	125	36	20	20.3
QSER/L2020-3T33	3	33	3	20	20	125	42	20	20.3
QSER/L2525-3T26	3	26	3	25	25	150	36	25	25.3
QSER/L2525-3T33	3	33	3	25	25	150	42	25	25.3
QSER/L2020-4T33	4	33	4	20	20	125	42	20	20.4
QSER/L2525-4T33	4	33	4	25	25	150	42	25	25.4
QSER/L2525-5T33	5	33	5	25	25	150	42	25	25.5

QSP

Blades for external deep grooving and parting

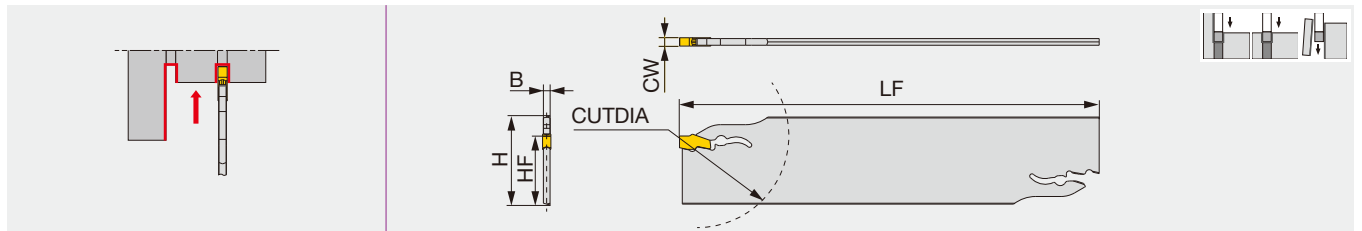

Designation	CW	CUTDIA	Seat size	H	B	LF	HF
QSP26-2D	2	52	2	26	1.8	150	21.4
QSP32-2D	2	66	2	32	1.8	150	24.8
QSP26-3D	3	75	3	26	2.4	150	21.4
QSP32-3D	3	120	3	32	2.4	150	24.8
QSP26-4D	4	80	4	26	3.2	150	21.4
QSP32-4D	4	120	4	32	3.2	150	24.9
QSP32-5D	5	120	5	32	4	150	24.9

SPARE PARTS

Designation	Wrench
QS...	QL-39

CTBU

Tool block for QSP blades

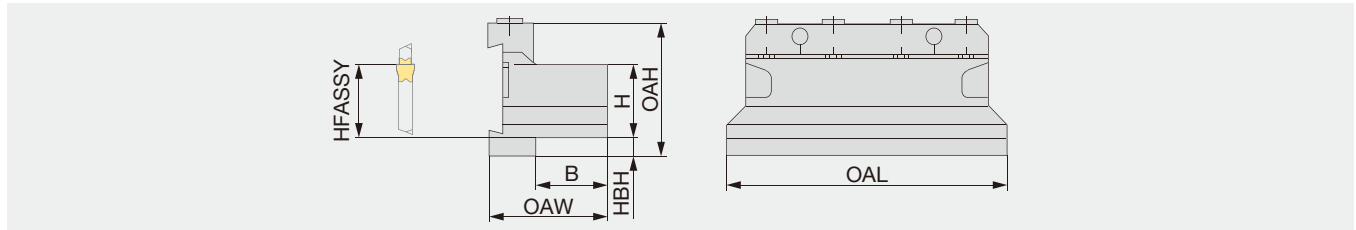

Designation	H	B	OAL	HFASSY	HBH	OAH	OAW	Blade (Optional)
CTBU20-26	20	21	86	20	9	43	38	QSP26...
CTBU25-26	25	23	110	25	5	45	43	QSP26...
CTBU20-32	20	19	100	20	13	50	38	QSP32...
CTBU25-32	25	23	110	25	8	50	42	QSP32...
CTBU32-32	32	29	110	32	5	54	48	QSP32...

SPARE PARTS

Designation	Clamp	Clamping screw	Wrench
CTBU20-26	CT-86	CM6X30-S	P-5
CTBU25-26	CT-105	CM6X30-S	P-5
CTBU20-32	CT-100	CM6X30-S	P-5
CTBU25-32	CT-110	CM6X30-S	P-5
CTBU32-32	CT-110	CM6X30-S	P-5

C-TBK-R/L

Toolholder with TungCap connection for parting-off blade

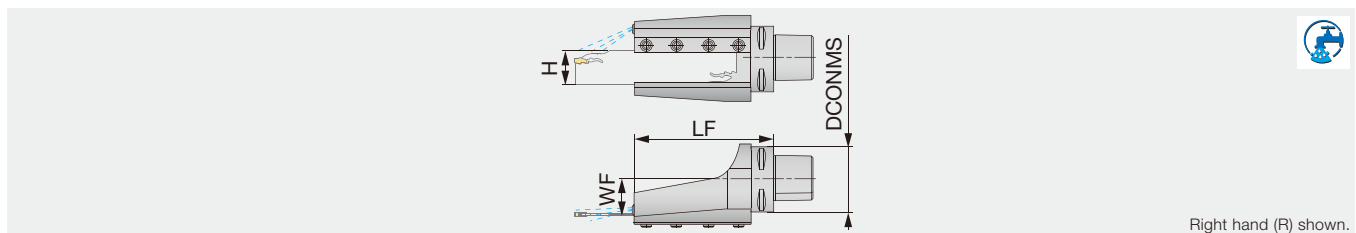

Designation	DCONMS	WF	LF	H
C6TBK-32R/L	63	32	138	32

Applicable for 3 MPa coolant

SPARE PARTS

Designation	Clamp	Clamping screw	Wrench	Coolant parts
C6TBK-32R/L	BK32-9WEDG	SRM6X16DIN912-12.9	HW5.0	EZ125

Reference pages: Inserts → **F227, F228**, Standard cutting conditions → **F228**



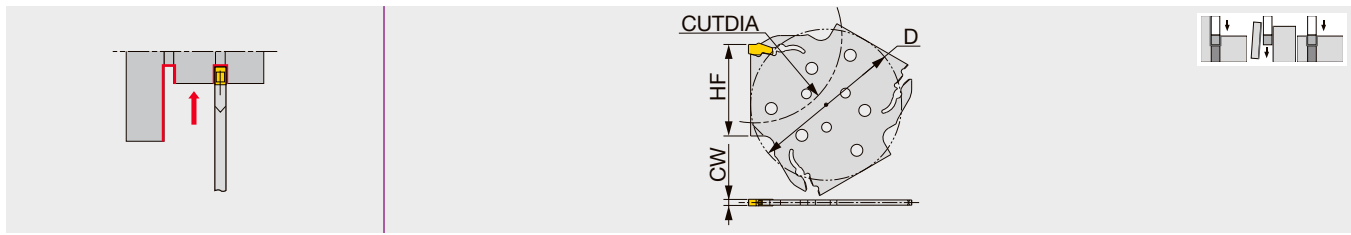

Designation	CW	Seat size	CUTDIA	HF	D
QSG52-2T	2	2	52	27	48.3
QSG82-2T	2	2	82	42	69.3
QSG52-3T	3	3	52	27	48.3
QSG82-3T	3	3	82	42	69.3
QSG120-3T	3	3	120	61	88
QSG52-4T	4	4	52	27	69.3
QSG82-4T	4	4	82	42	69.3
QSG120-4T	4	4	120	61	88
QSG120-5T	5	5	120	61	88



SPARE PARTS

Designation	Wrench
QSG...	QL-39

CHTBR/L

Tool block for QSG blade

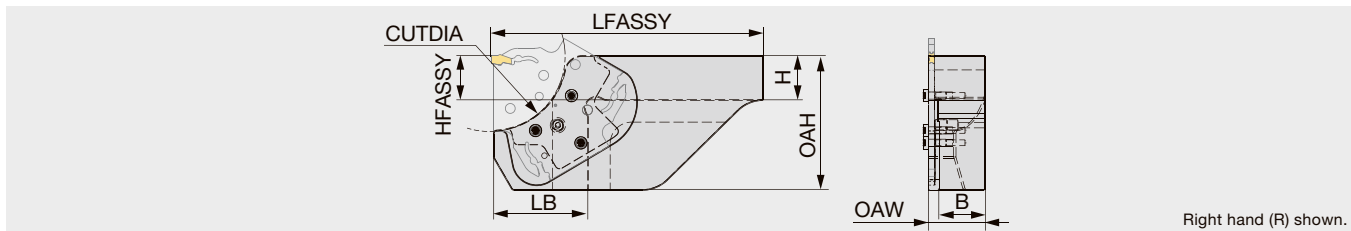

Designation	CUTDIA	H	B	LFASSY	HFASSY	OAH	OAW	LB
CHTBR/L2020-52	52	20	20.5	100	20	50	26.5	37
CHTBR/L2525-52	52	25	25.5	125	25	50	31.5	37
CHTBR/L2020-82	82	20	20.5	140	20	75	26.5	53
CHTBR/L2525-82	82	25	25.5	150	25	75	31.5	53
CHTBR/L2525-120	120	25	25.5	165	25	100	31.5	67
CHTBR/L3232-120	120	32	32.5	165	32	100	38.5	67

The blade clamping screw heads protrude out for as much as 3.1 mm over the insert cutting edge point. Maintain the clearance from the chucking device to avoid interference.

SPARE PARTS

Designation	Clamping screw	Grip	Torx bit
CHTBR/L...	SR ISO 14580 M4X10	SW6-SD	BLDT20/S7

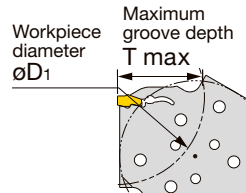

Maximum groove depth (T max) as function of workpiece diameter (øD1)

Designation	øD1																	
CHTBR/L****-D52	53	54	55	56	58	60	62	65	68	72	78	84	92	102	115	133	159	198
CHTBR/L****-D82	104	108	112	116	121	127	134	142	151	162	176	192	212	237	270	313	375	468
CHTBR/L****-D120	205	214	224	235	247	261	278	297	319	345	376	414	462	522	601	709	865	1112
T max	21	20	19	18	17	16	15	14	13	12	11	10	9	8	7	6	5	4

Designation	øD1												
CHTBR/L****-D82	83	84	84	85	86	87	89	90	92	94	96	98	101
CHTBR/L****-D120	144	147	150	153	156	160	164	168	173	178	184	190	197
T max	34	33	32	31	30	29	28	27	26	25	24	23	22

Designation	øD1																
CHTBR/L****-D120	121	122	123	124	125	126	127	128	129	130	131	133	134	136	138	140	142
T max	55	52	50	48	47	46	45	44	43	42	41	40	39	38	37	36	35

Reference pages: Inserts → **F227, F228**, Standard cutting conditions → **F228**

CHIPBREAKER GUIDE

QGM



First choice for grooving and parting

Smooth chip evacuation
Well-designed edge with high strength
CW = 2 - 5 mm

TUNGFEED-BLADE

Enables high feed machining when combined with extremely rigid TungFeed-Blade toolholder

CW = 2 - 5 mm
CUTDIA = $\varnothing 52, \varnothing 82, \varnothing 120$ mm

Standard feed

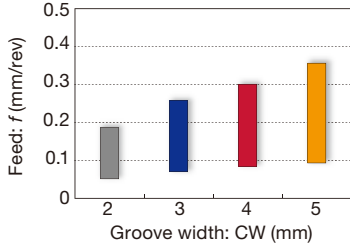

Groove width: CW (mm)	Feed: f (mm/rev)
2	0.18
3	0.25
4	0.29
5	0.35

Recommended feed when using TungFeed-Blade

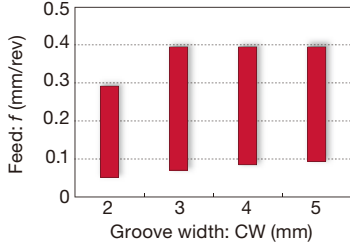

Groove width: CW (mm)	Feed: f (mm/rev)
2	0.28
3	0.39
4	0.39
5	0.39

QGS



Lower cutting force and superior sharpness

Uniquely designed edge and chipbreaker
CW = 2 - 5 mm

Standard feed

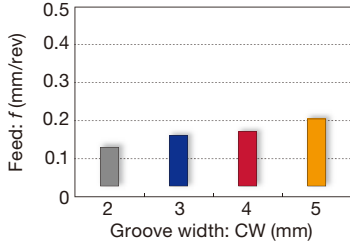

Groove width: CW (mm)	Feed: f (mm/rev)
2	0.12
3	0.16
4	0.17
5	0.20

INSERTS

QGM

External deep grooving and parting

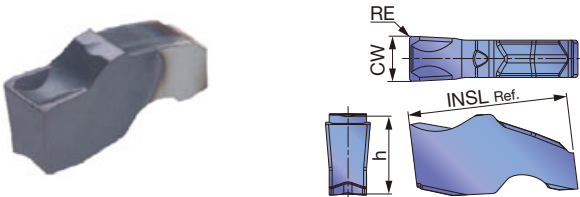

	P	M	K	N	S	H
Steel	★					
Stainless	★					
Cast iron	★					
Non-ferrous						
Superalloys	★					
Hard materials						

★ : First choice

Designation	Seat size	CW ± 0.05	RE	Coated						INSL	h
				AH7025							
QGM2-020	2	2	0.2	●						11	5.3
QGM3-020	3	3	0.2	●						11	5.3
QGM4-030	4	4	0.3	●						13	7.3
QGM5-030	5	5	0.3	●						13	7.3

●: Line up

Reference pages: Toolholders → **F224 - F226**, Standard cutting conditions → **F228**



QGS

External deep grooving and parting

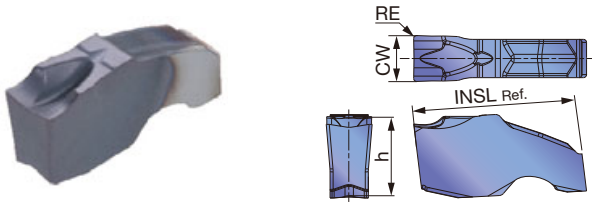

P	Steel	★							
M	Stainless	★							
K	Cast iron	★							
N	Non-ferrous								
S	Superalloys	★							
H	Hard materials								

★ : First choice

Designation	Seat size	CW±0.05	RE	Coated						INSL	h
				AH7025							
QGS2-020	2	2	0.2	●						11	5.3
QGS3-020	3	3	0.2	●						11	5.3
QGS4-030	4	4	0.3	●						13	7.3
QGS5-030	5	5	0.3	●						13	7.3

● : Line up

STANDARD CUTTING CONDITIONS

ISO	Workpiece material	Hardness	Grade	Cutting speed Vc (m/min)
P	Steels C45, 34CrMo4, etc.	< 300 HB	AH7025	50 - 180
M	Stainless steel X10CrNiS18-9, etc.	< 200 HB	AH7025	50 - 120
K	Gray cast iron GG25, 250, etc.	-	AH7025	50 - 180
	Ductile cast irons GGG45, 450-10S, etc.	-	AH7025	50 - 120
S	Superalloys Inconel718, etc.	< HRC 40	AH7025	20 - 60
	Titanium alloys Ti-6Al-4V, etc.	< HRC 40	AH7025	20 - 80

Please see page F227 for feed: f (mm/rev).

Reference pages: Toolholders → [F224 - F226](#)

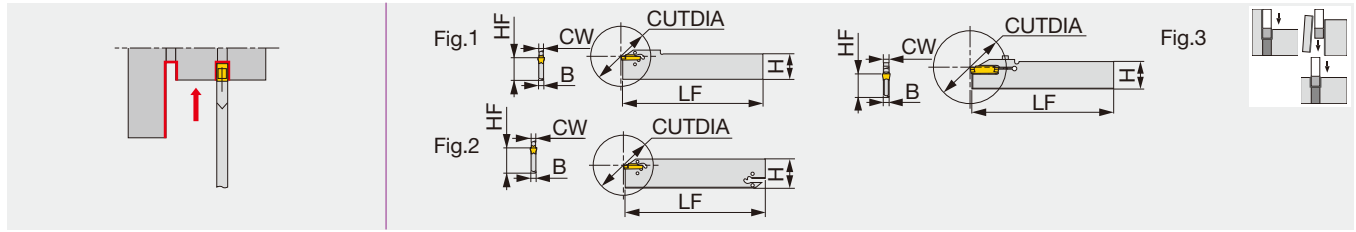

Designation	CW	Seat size	CUTDIA	H	B	LF	HF	Fig.	Torque*
CGP26-1.4S	1.4	1	26	26	1	150	21.4	1	-
CGP32-1.4D	1.4	1	26	32	1	150	24.8	2	-
CGP26-2S	2	2	40	26	1.8	150	21.4	1	-
CGP32-2D	2	2	50	32	1.8	150	24.8	2	-
CGP26-3S	3	3	50	26	2.4	150	21.4	1	-
CGP32-3D	3	3	100	32	2.4	150	24.8	2	-
CGP26-4S	4	4	80	26	3.2	150	21.4	1	-
CGP32-4D	4	4	100	32	3.2	150	24.9	2	-
CGP45-4D	4	4	120	45	3.2	150	38.1	2	-
CGP32-5D	5	5	120	32	4	150	24.9	2	-
CGP32-6D	6	6	120	32	5.2	150	24.9	2	-
CGP32-8S-CL	8	8	80	32	6.2	150	24.9	3	3

When depth is deeper than (insert length - 1.5mm), 1 corner type is recommended.
Wrench (CRW...) is not included. Please order it separately.
*Torque: Recommended clamping torque (N·m)

SPARE PARTS

Designation	Clamping screw	Wrench	Wrench (Optional)
CGP**-1.4*	-	-	CRW23
CGP**-2/3/4/5/6	-	-	CRW33
CGP32-8S-CL	CM4X0.7X20-M0-A	P-3	-

Caution

Newly developed clamp

Insert is clamped by the elastic deformation of upper jaw.
Low clamping stress increases the stability and tool life.



Tool block for CGP blade, mono block

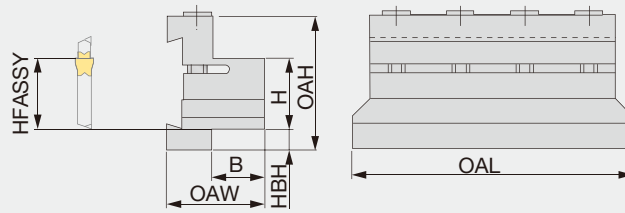

Designation	H	B	OAL	HFASSY	HBH	OAH	OAW	Blade (Optional)
CTBF25-45	25	22	110	25	25	66	40	CGP45...
CTBF32-45	32	28	120	32	18	66	45	CGP45...

External

Internal

Face

Parting

Others

CTBU

Tool block for CGP blade

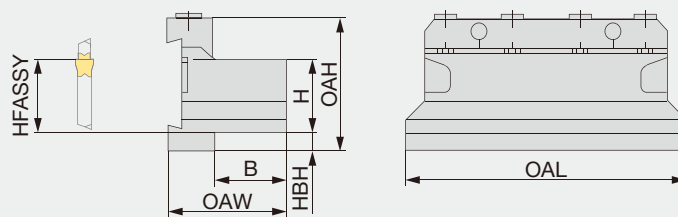

Designation	H	B	OAL	HFASSY	HBH	OAH	OAW	Blade (Optional)
CTBU20-26	20	21	86	20	9	43	38	CGP26...
CTBU25-26	25	23	110	25	5	45	43	CGP26...
CTBU20-32	20	19	100	20	13	50	38	CGP32...
CTBU25-32	25	23	110	25	8	50	42	CGP32...
CTBU32-32	32	29	110	32	5	54	48	CGP32...

SPARE PARTS

Designation	Clamp	Clamping screw	Wrench
CTBU20-26	CT-86	CM6X30-S	P-5
CTBU25-26	CT-105	CM6X30-S	P-5
CTBU20-32	CT-100	CM6X30-S	P-5
CTBU25-32	CT-110	CM6X30-S	P-5
CTBU32-32	CT-110	CM6X30-S	P-5

C-TBK-R/L

Toolholder with TungCap connection for parting-off blade

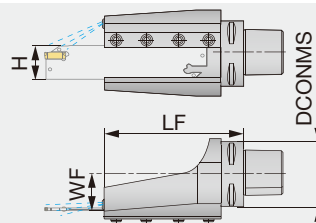

Right hand (R) shown.

Designation	DCONMS	WF	LF	H
C6TBK-32R/L	63	32	138	32

Applicable for 3 MPa coolant

SPARE PARTS

Designation	Clamp	Clamping screw	Wrench	Coolant parts
C6TBK-32R/L	BK32-9WEDG	SRM6X16DIN912-12.9	HW5.0	EZ125

Reference pages: Inserts → **F236 - F245**, Blades → **F229**, Standard cutting conditions → **F246**

CGP32-CHP

External deep grooving and parting blade, with high pressure coolant capability

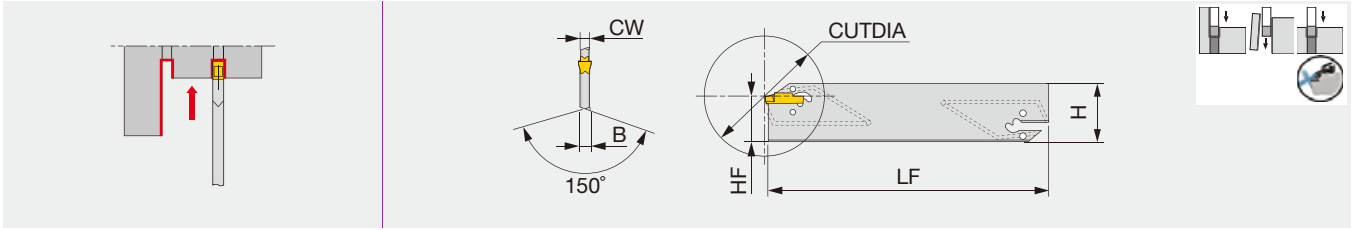

Designation	CW	Seat size	CUTDIA	H	B	LF	HF
CGP32-2D-CHP	2	2	50	32	1.8	150	24.8
CGP32-3D-CHP	3	3	90	32	2.5	150	24.8
CGP32-4D-CHP	4	4	90	32	3.2	150	24.9
CGP32-5D-CHP	5	5	110	32	4	150	24.9
CGP32-6D-CHP	6	6	110	32	5.2	150	24.9

When depth is deeper than (insert length - 1.5mm), 1 corner type is recommended.
Wrench (CRW...) is not included. Please order it separately.

SPARE PARTS

Designation	Sealing screw	Wrench (Optional)
CGP32-*D-CHP	SGC340	CRW33

Caution

Newly developed clamp

Insert is clamped by the elastic deformation of upper jaw.
Low clamping stress increases the stability and tool life.

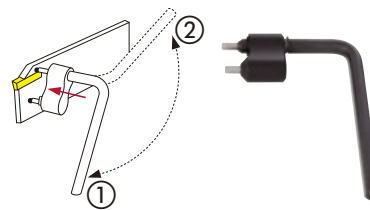

①→② : unclamp
②→① : clamp

CTBU-CHP

Tool block for CGP-CHP blade, with high pressure coolant capability

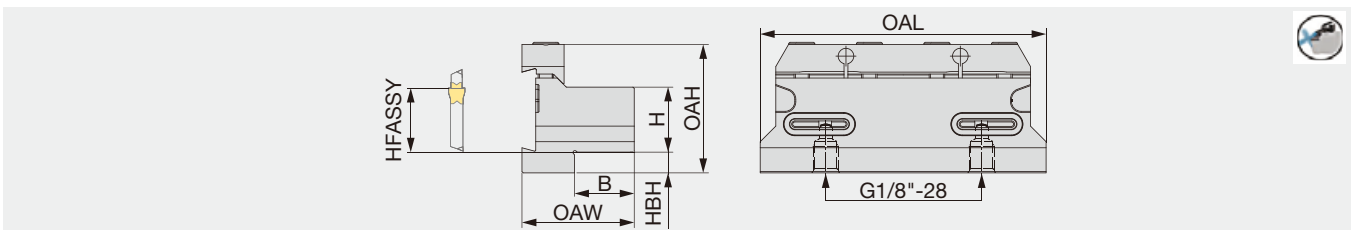

Designation	H	B	OAL	HFASSY	HBH	OAH	OAW	Blade (Optional)
CTBU25-32-CHP	25	23	110	25	8	50	43.2	CGP32-*D-CHP

Applicable for 14 MPa coolant

SPARE PARTS

Designation	Clamping screw	Clamp	Wrench	O-ring
CTBU25-32-CHP	SRM6X16DIN912-12.9	CT-110	P-5	OR14X2.5NN

Reference pages: Inserts → **F236 - F245**, Standard cutting conditions → **F246**
Parts for coolant hose → **F266**

External grooving and parting toolholder, for Swiss lathes

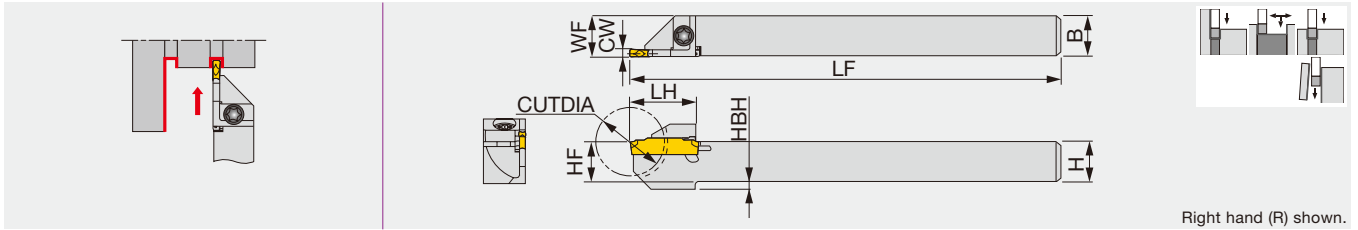

Designation	CW	Seat size	CUTDIA	H	B	LF	LH	HF	WF ⁽¹⁾	HBH	Torque*
JCTER/L1010X1.4T10	1.4	1	20	10	10	120	18	10	10.2	-	3
JCTER/L1212F1.4T12	1.4	1	24	12	12	85	19.5	12	12.2	-	3
JCTER/L1212X1.4T12	1.4	1	24	12	12	120	19.5	12	12.2	-	3
JCTER/L1414-1.4T12	1.4	1	24	14	14	125	19.5	14	14.2	-	3
JCTER/L1616X1.4T16	1.4	1	32	16	16	120	24	16	16.2	-	3
JCTER/L1010X2T10	2	2	20	10	10	120	19	10	10.1	2	3
JCTER/L1212F2T12	2	2	24	12	12	85	19	12	12.1	2	3
JCTER/L1212X2T12	2	2	24	12	12	120	19	12	12.1	2	3
JCTER/L1414-2T12	2	2	24	14	14	125	19	14	14.1	-	3
JCTER/L1616X2T16	2	2	32	16	16	120	24	16	16.1	-	3
JCTER/L1212F3T12	3	3	24	12	12	85	19	12	12.3	2	3
JCTER/L1212X3T12	3	3	24	12	12	120	19	12	12.3	2	3
JCTER/L1616X3T16	3	3	32	16	16	120	24	16	16.3	-	3
JCTER/L2020H3T16	3	3	32	20	20	100	24	20	20.3	-	3

(1) "WF" value is calculated with groove width "CW" shown in the table.
Torque*: Recommended clamping torque (N·m)

JCTER/L2012

External grooving and parting toolholder, for Swiss lathes, with 20 mm shank height

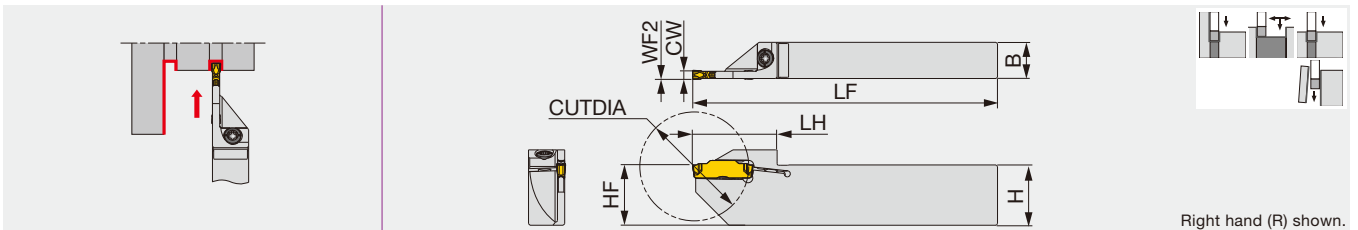

Designation	CW	Seat size	CUTDIA	H	B	LF	LH	HF	WF2 ⁽¹⁾	Torque*
JCTER/L2012H2T18	2	2	36	20	12	100	25	20	0.1	3
JCTER/L2012H3T21	3	3	42	20	12	100	28	20	0.3	3

(1) "WF2" value is calculated with groove width "CW" shown in the table.
Torque*: Recommended clamping torque (N·m)

SPARE PARTS

Designation	Clamping screw	Wrench
JCTER/L...	CSHB-4-A	T-15F

Reference pages: Inserts → **F236 - F245**, Standard cutting conditions → **F246**

JCTER/L-CHP

Direct connection

External grooving and parting toolholder, with high pressure coolant capability

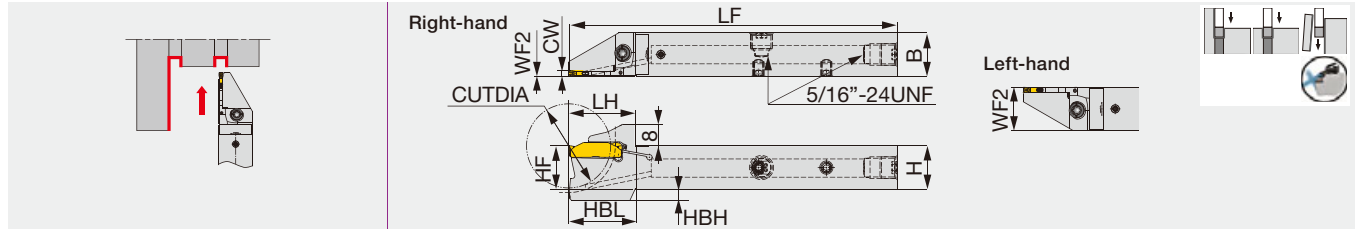

Designation	CW	Seat size	CUTDIA	H	B	LF	LH	HF	WF2 ⁽¹⁾	HBH	HBL	Torque*
JCTER/L1212X2T12-CHP	2	2	25	12	12	120	24.7	12	0/12	5	24.7	3
JCTER/L1616X2T12-CHP	2	2	25	16	16	120	24.7	16	0/16	1	24.5	3
JCTER/L1616X2T16-CHP	2	2	32	16	16	120	24.7	16	0/16	4	24.7	3
JCTER/L2020X2T16-CHP	2	2	32	20	20	120	24.7	20	0/20	-	-	3

(1) "WF2" value is calculated with groove width "CW" shown in the table. The first value before "/" indicates the WF2 for the right-hand holder and the second value after "/" for the left-hand holder.

Torque*: Recommended clamping torque (N·m)

SPARE PARTS

Designation	Clamping screw	Wrench 1	Coolant plug	Wrench 2	DirectJet plug	Wrench 3
JCTER/L...	CSHB-4-A	T-15F	SR5/16UNFTL360	P-4	SSHM4-6-TB	P-2

JTTER/L

External grooving and parting toolholder, for Swiss lathes

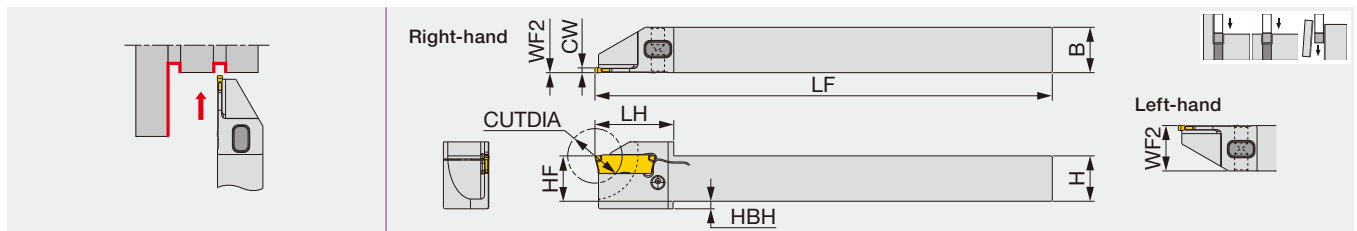

Designation	CW	Seat size	CUTDIA	H	B	LF	LH	HF	WF2 ⁽¹⁾	HBH	Torque*
JTTER/L1010H1.2D12	1.2	0.9	12	10	10	100	17	10	0/10	-	1.5
JTTER/L1212F1.2D16	1.2	0.9	16	12	12	85	19	12	0/12	-	1.5
JTTER/L1212X1.2D16	1.2	0.9	16	12	12	120	19	12	0/12	-	1.5
JTTER/L1212X1.2D20	1.2	0.9	20	12	12	120	21	12	0/12	2	1.5
JTTER/L1616X1.2D20	1.2	0.9	20	16	16	120	21	16	0/16	-	2

(1) "WF2" value is calculated with groove width "CW" shown in the table. The first value before "/" indicates the WF2 for the right-hand holder and the second value after "/" for the left-hand holder.

Torque*: Recommended clamping torque (N·m)

SPARE PARTS

Designation	Clamping screw	Clamping pin	Wrench
JTTER/L1010...	SSM3.5x0.35	PIN-SL-TC	P-2F
JTTER/L1212...	SSM3.5x0.35	PIN-SL-TC	P-2F
JTTER/L1616...	SRM5-24145-RL	PIN-32121	P-2.5F

Reference pages: Inserts → **F236 - F245**, Standard cutting conditions → **F246**
Parts for coolant hose → **F266**



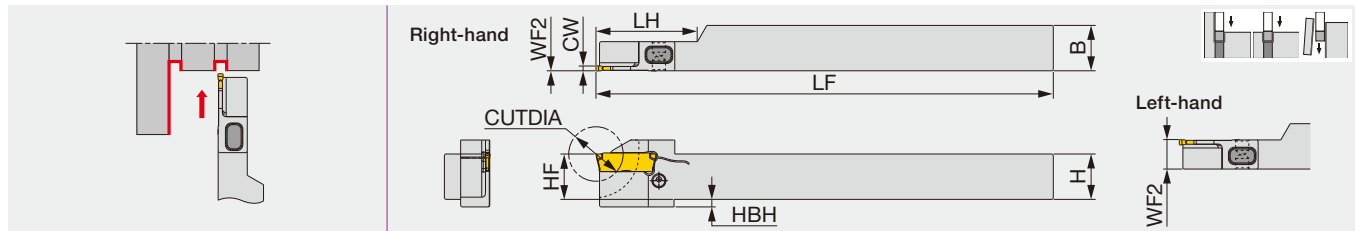

Designation	CW	Seat size	CUTDIA	H	B	LF	LH	HF	WF2 ⁽¹⁾	HBH	Torque*
JTTER/L1010H1.2D12-S	1.2	0.9	12	10	10	100	22.8	10	0/7.7	-	1.5
JTTER1212F1.2D16-S ⁽²⁾	1.2	0.9	16	12	12	85	22.8	12	0	-	1.5
JTTER/L1212X1.2D16-S	1.2	0.9	16	12	12	120	26.8	12	0/7.7	-	1.5
JTTER/L1212X1.2D20-S	1.2	0.9	20	12	12	120	26.8	12	0/7.7	2	1.5
JTTER/L1616X1.2D20-S	1.2	0.9	20	16	16	120	26.8	16	0/7.7	-	1.5

(1) "WF2" value is calculated with groove width "CW" shown in the table. The first value before "/" indicates the WF2 for the right-hand holder and the second value after "/" for the left-hand holder.

(2) No clamping screw from the insert side.
Torque*: Recommended clamping torque (N·m)

SPARE PARTS

Designation	Clamping screw	Clamping pin	Wrench
JTTER/L*-S	SSM3.5x0.35	PIN-SL-TC	P-2F

CHGP

Parting-off and external grooving blade

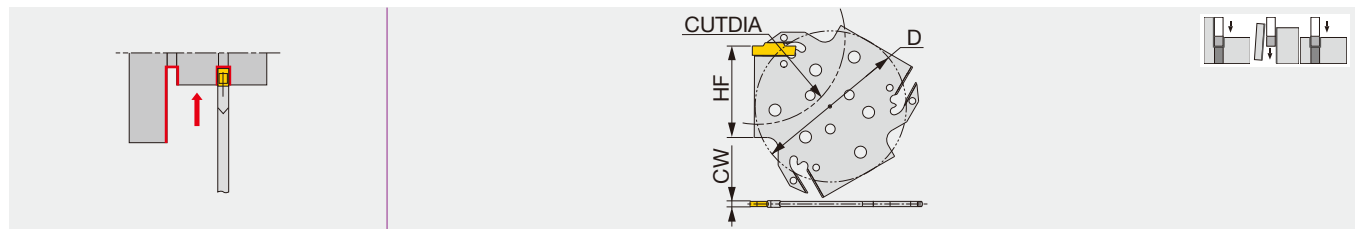

Designation	CW	Seat size	CUTDIA	HF	D
CHGP52-2T	2	2	52	27	48.3
CHGP52-3T	3	3	52	27	48.3
CHGP82-3T	3	3	82	42	69.3
CHGP82-4T	4	4	82	42	69.3

When depth is deeper than insert length - 1.5mm, 1 corner type is recommended.

SPARE PARTS

Designation	Wrench (Option)
CHGP...	CRW33

CHTBR/L

Tool block for CHGP blade

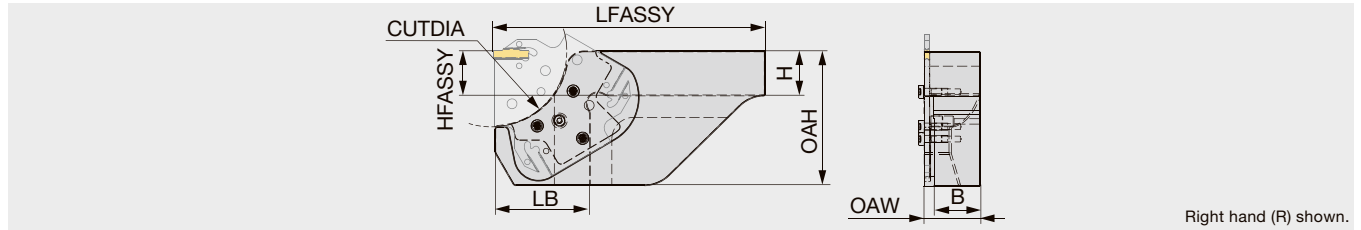

Designation	CUTDIA	H	B	OAL	OAH	OAW	LB
CHTBR/L2020-52	52	20	20.5	100	50	26.5	37
CHTBR/L2525-52	52	25	25.5	125	50	31.5	37
CHTBR/L2020-82	82	20	20.5	140	75	26.5	53
CHTBR/L2525-82	82	25	25.5	150	75	31.5	53

Note: The blade clamping screw heads protrude out for as much as 3.1 mm over the insert cutting edge point. Maintain the clearance from the chucking device to avoid interference.

SPARE PARTS



Designation	Clamping screw	Grip	Torx bit
CHTBR/L...	SR ISO 14580 M4X10	SW6-SD	BLDT20/S7

Maximum groove depth (T max) as function of workpiece diameter (ϕD_1)

Designation	ϕD_1																	
CHTBR/L****-D52	53	54	55	56	58	60	62	65	68	72	78	84	92	102	115	133	159	198
CHTBR/L****-D82	104	108	112	116	121	127	134	142	151	162	176	192	212	237	270	313	375	468
T max	21	20	19	18	17	16	15	14	13	12	11	10	9	8	7	6	5	4

Designation	ϕD_1											
CHTBR/L****-D82	83	84	85	86	87	89	90	92	94	96	98	101
T max	34	33	31	30	29	28	27	26	25	24	23	22

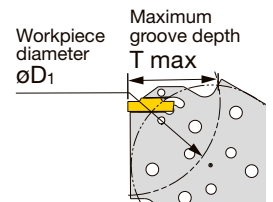

Reference pages: Inserts → [F236 - F245](#), Standard cutting conditions → [F246](#)



External grooving and parting

DGM type (2 corners)
SGM type (1 corner)

1st choice for grooving and parting

Smooth chip evacuation
Well-designed edge with high strength
Handed insert available
CW = 2 - 8 mm

TUNGFEED^{BLADE}

Enables high feed machining when combined with extremely rigid TungFeed-Blade toolholder
CW = 2 - 4 mm
CUTDIA = \varnothing 52, \varnothing 82 mm



F239, F240

■ Standard feed

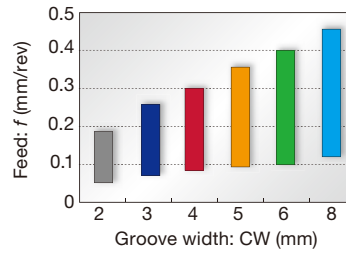

■ Recommended feed when using TungFeed-Blade

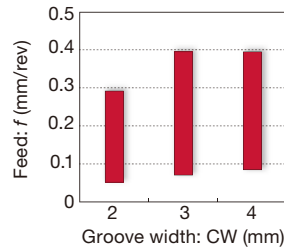

DGS type (2 corners)
SGS type (1 corner)

Lower cutting force and superior sharpness

Unique-designed edge and chipbreaker
Handed insert available
CW = 1.2 - 8 mm



F241, F242

■ Standard feed

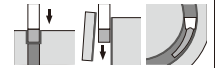
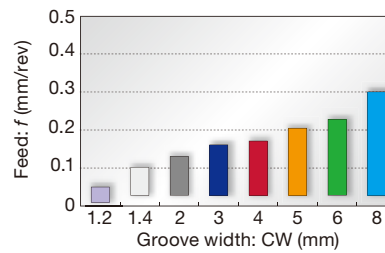

DGG type (2 corners)

For non-ferrous materials and titanium

Chipbreaker with low cutting force
Sharp cutting edge that prevents vibration and delivers fine surface finish
CW = 2 - 6 mm



F243

■ Standard feed

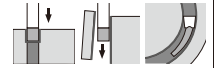
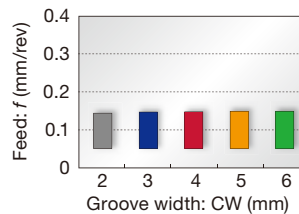

DGL type (2 corners)

1st choice for mild steel

Chipbreaker with excellent chip control at low feed
Suitable for mild steel that often gives difficulties in chip control
CW = 2 - 6 mm



F243

■ Standard feed

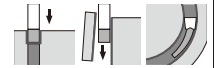
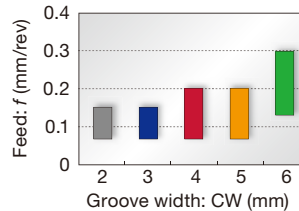

External grooving and parting

DTM type
(2 corners)



F244

General purpose

1st choice for grooving and turning
Suitable for light to medium cutting
Excellent chip control in machining steel, alloy steel, stainless steel, and heat-resistant alloy
CW = 2 - 8 mm

Standard feed and DoC (for turning)

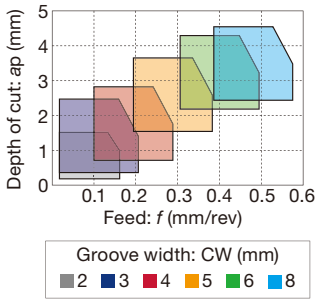

Standard feed

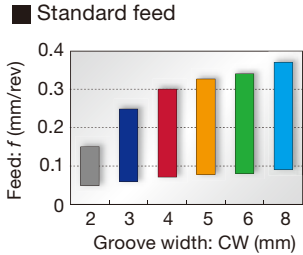

External grooving, turning and parting

DTE type
(2 corners)



F244, F245

General purpose

Unique chipbreaker makes chips shorter
Molded and ground insert available
CW = 2.65 - 8 mm

Standard feed and DoC (for turning)

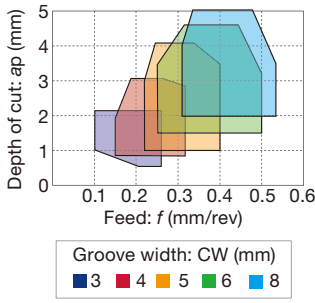

Standard feed

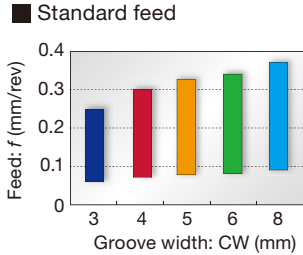

DTX type
(2 corners)



F245

Multi-functional type

Well balanced sharpness and strength
Multi-functional insert
CW = 2 - 8 mm

Standard feed and DoC (for turning)

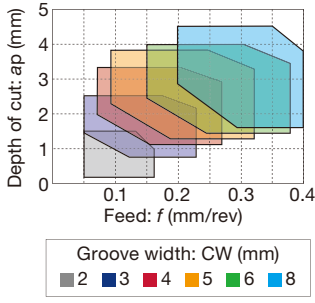

Standard feed

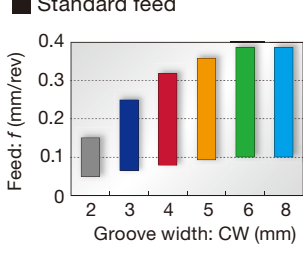

Please see page F*** for the product details.



GRADE SELECTION

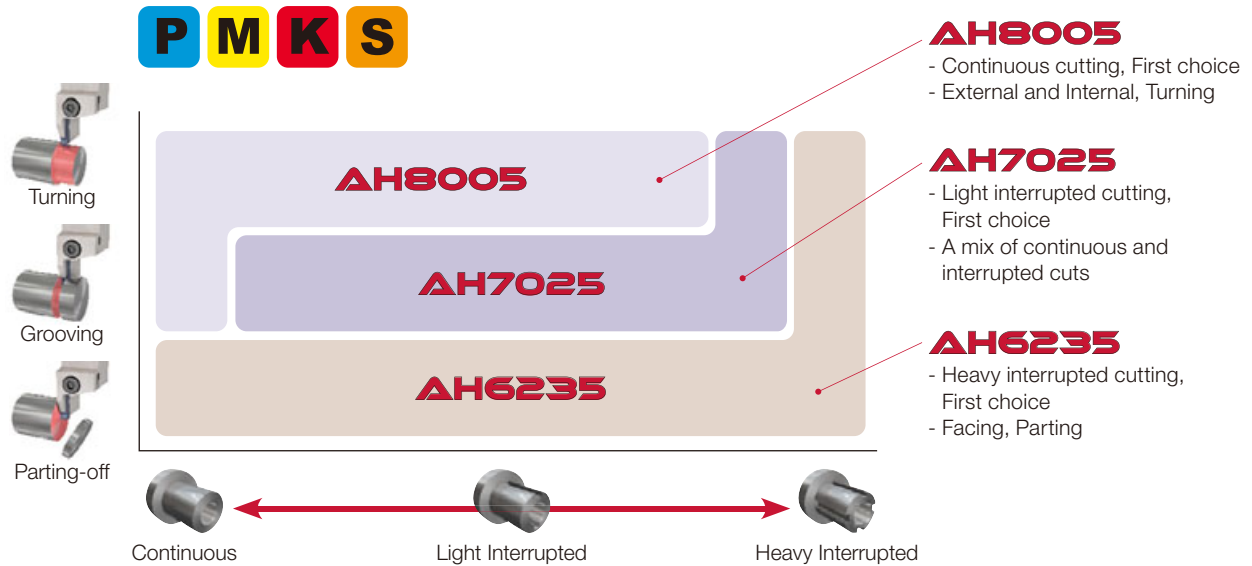

GRADES

AH8005 **P M K S**

- First choice for external, internal, and side-turning, continuous cuts

AH7025 **P M K S**

- First choice for light interrupted cuts or a mix of continuous and interrupted cuts
- New PVD coating with high Al content provides excellent adhesion strength
- Improved wear and chipping resistance

AH6235 **P M K**

- First choice for heavy interrupted cuts, as well as parting and facing applications

AH725 **P M S**

- General purpose PVD grade for high fracture resistance

T515 **K**

- First recommended grade for cast iron
- Excellent wear resistance in high speed machining

T9225 **P**

- Suitable for steel machining at high speeds
- New CVD coating and substrate deliver an outstanding balance of wear and chipping resistance

NS9530 **P**

- Advanced cermet for finish cutting of steel
- Innovative grade with incredible fracture and high wear resistance

GH130 **P M K**

- Recommended for interrupted machining
- TiCNO PVD coating layer with high wear resistance
- High hardness wear resistance

AH905 **S**

- Remarkable for machining of heat resistant alloys
- Exclusive coating layer improves adhesion strength and wear resistance

KS05F **N S**

- Recommended for non-ferrous materials and titanium

TH10 **N**

- Recommended for non-ferrous materials

BXA10 **H**

- Coated CBN grade designed for turning hardened steel parts

BX360 **H**

- Developed for grooving applications of hardened steel parts

INSERTS

DGM

External grooving and parting

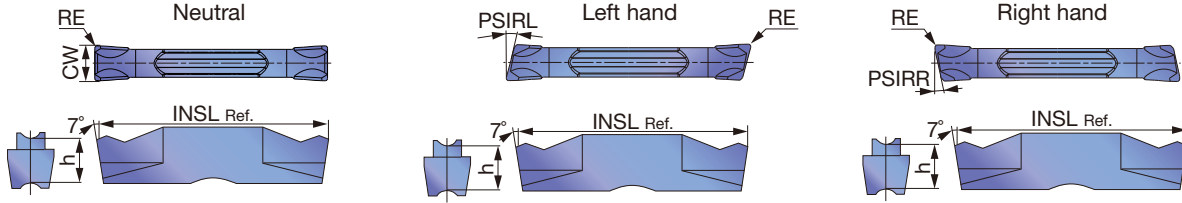

P	Steel	★	★	☆	★	☆	★	★	★					
M	Stainless		★	☆	★	★	★	★	★					
K	Cast iron		★		★	☆	☆	★	★	☆				
N	Non-ferrous										☆			
S	Superalloys		★	☆	★	★					★			
H	Hard materials													

★ : First choice
☆ : Second choice

Designation	Seat size	HAND	CW±0.05	RE	Coated						Cermet	Uncoated		INSL	h	PSIRL	PSIRR
					T9225	AH7025	AH725	AH8005	AH905	GH130		AH6235	NS9530				
DGM2-020	2	N	2	0.2	●	●	●	●	●	●	●	●		20	5	0°	0°
DGM2-020-6R	2	R	2	0.2		●	●			●				20	5	0°	6°
DGM2-020-6L	2	L	2	0.2		●	●			●				20	5	6°	0°
DGM2-020-8R	2	R	2	0.2		●	●			●				20	5	0°	8°
DGM2-020-8L	2	L	2	0.2		●	●			●				20	5	8°	0°
DGM2-020-15R	2	R	2	0.2		●	●			●				20	5	0°	15°
DGM2-020-15L	2	L	2	0.2		●	●			●				20	5	15°	0°
DGM2-002-15R	2	R	2	0.02			●			●				19.35	5	0°	15°
DGM2-002-15L	2	L	2	0.02			●			●				19.35	5	15°	0°
DGM2.39-020	2	N	2.39	0.2		●		●		●				20	5	0°	0°
DGM3-020	3	N	3	0.2	●	●	●	●	●	●	●	●		20	5	0°	0°
DGM3-020-6R	3	R	3	0.2		●	●			●				20	5	0°	6°
DGM3-020-6L	3	L	3	0.2		●	●			●				20	5	6°	0°
DGM3-002-6R	3	R	3	0.02			●			●				19.45	5	0°	6°
DGM3-002-6L	3	L	3	0.02			●			●				19.45	5	6°	0°
DGM3-020-15R	3	R	3	0.2		●	●			●				20	5	0°	15°
DGM3-020-15L	3	L	3	0.2		●	●			●				20	5	15°	0°
DGM3.18-020	3	N	3.18	0.2		●		●		●				20	5	0°	0°
DGM4-030	4	N	4	0.3	●	●	●	●	●	●	●	●		20	5	0°	0°
DGM4-030-4R	4	R	4	0.3		●	●			●				20	5	0°	4°
DGM4-030-4L	4	L	4	0.3		●	●			●				20	5	4°	0°
DGM4-030-15R	4	R	4	0.3		●	●			●				20	5	0°	15°
DGM4-030-15L	4	L	4	0.3		●	●			●				20	5	15°	0°
DGM4.76-040	5	N	4.76	0.4		●		●		●				25	5.5	0°	0°
DGM5-030	5	N	5	0.3	●	●	●	●	●	●	●	●		25	5.5	0°	0°
DGM5-030-4R	5	R	5	0.3		●	●			●				25	5.5	0°	4°
DGM6-030	6	N	6	0.3	●	●	●	●	●	●	●	●		25	5.5	0°	0°
DGM6.35-040	6	N	6.35	0.4		●		●		●				25	5.5	0°	0°
DGM8-040	8	N	8	0.4	●	●	●	●	●	●	●	●		30	6.7	0°	0°

● : Line up

SGM

External deep grooving and parting

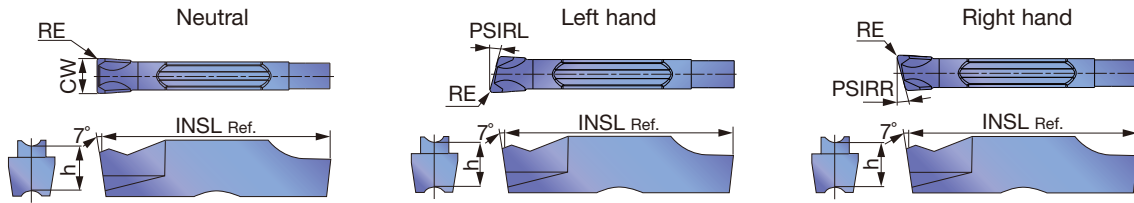

P Steel	★	☆	★	☆	★								
M Stainless	★	☆	★	★	★								
K Cast iron	★		★	☆	★		☆						
N Non-ferrous							☆						
S Superalloys	★	☆	★				★						
H Hard materials													

★ : First choice
☆ : Second choice

Designation	Seat size	HAND	CW±0.05	RE	Coated					Uncoated				INSL	h	PSIRL	PSIRR
					AH7025	AH725	AH8005	GH130	AH6235	KS05F							
SGM2-020	2	N	2	0.2	●	●	●	●	●	●				20	5	0°	0°
SGM2-020-6R	2	R	2	0.2	●	●	●	●	●					20	5	0°	6°
SGM2-020-6L	2	L	2	0.2	●	●	●	●	●					20	5	6°	0°
SGM3-020	3	N	3	0.2	●	●	●	●	●	●				20	5	0°	0°
SGM3-020-6R	3	R	3	0.2	●	●	●	●	●					20	5	0°	6°
SGM3-020-6L	3	L	3	0.2	●	●	●	●	●					20	5	6°	0°
SGM3-020-15R	3	R	3	0.2	●	●	●	●	●					20	5	0°	15°
SGM3-020-15L	3	L	3	0.2	●	●	●	●	●					20	5	15°	0°
SGM4-030	4	N	4	0.3	●	●	●	●	●	●				20	5	0°	0°
SGM4-030-4R	4	R	4	0.3	●	●	●	●	●					20	5	0°	4°
SGM4-030-4L	4	L	4	0.3	●	●	●	●	●					20	5	4°	0°
SGM5-030	5	N	5	0.3	●	●	●	●	●	●				25	5.5	0°	0°
SGM6-030	6	N	6	0.3	●	●	●	●	●	●				25	5.5	0°	0°
SGM8-040	8	N	8	0.4	●		●		●	●				30	6.7	0°	0°

● : Line up

Reference pages: Toolholders → [F229 - F235](#), Standard cutting conditions → [F246](#)

External grooving and parting

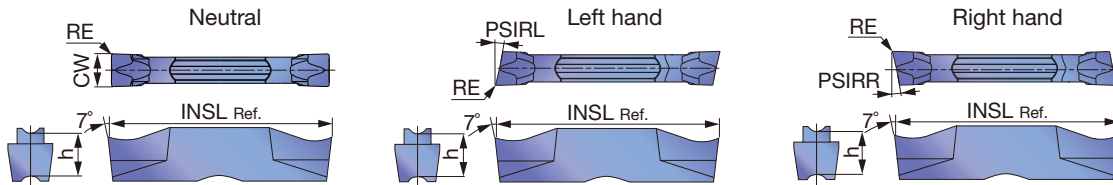

	P	M	K	N	S	H								
Steel	★	★	☆	★	☆	★	★							
Stainless		★	☆	★	★	★								
Cast iron		★		★	☆	★	☆							
Non-ferrous												☆		
Superalloys		★	☆	★								★		
Hard materials														

★ : First choice
☆ : Second choice

Designation	Seat size	HAND	CW±0.05	RE	Coated						Cermet		Uncoated		INSL	h	PSIRL	PSIRR
					T9225	AH7025	AH725	AH8005	GH130	AH6235	NS9530		KS05F					
DGS1.2-003	0.9	N	1.2	0.03				●							16	4.7	0°	0°
DGS1.4-005	1	N	1.4	0.05				●							16	4.3	0°	0°
DGS1.4-010	1	N	1.4	0.1				●							16	4.3	0°	0°
DGS1.4-016	1	N	1.4	0.16			●			●					16	4.3	0°	0°
DGS2-005	2	N	2	0.05				●							20	5	0°	0°
DGS2-010	2	N	2	0.1				●							20	5	0°	0°
DGS2-020	2	N	2	0.2	●	●	●	●	●	●	●		●		20	5	0°	0°
DGS2-020-6R	2	R	2	0.2		●	●		●						20	5	0°	6°
DGS2-020-6L	2	L	2	0.2		●	●		●						20	5	6°	0°
DGS2-002-6R	2	R	2	0.02				●							19.5	5	0°	6°
DGS2-002-6L	2	L	2	0.02				●							19.5	5	6°	0°
DGS2-020-15R	2	R	2	0.2		●	●		●						20	5	0°	15°
DGS2-020-15L	2	L	2	0.2		●	●		●						20	5	15°	0°
DGS2-002-15R	2	R	2	0.02				●							19.5	5	0°	15°
DGS2-002-15L	2	L	2	0.02				●							19.5	5	15°	0°
DGS2.39-020	2	N	2.39	0.2		●		●		●					20	5	0°	0°
DGS3-020	3	N	3	0.2	●	●	●	●	●	●	●	●	●		20	5	0°	0°
DGS3-020-6R	3	R	3	0.2		●	●		●						20	5	0°	6°
DGS3-020-6L	3	L	3	0.2		●	●		●						20	5	6°	0°
DGS3-002-6R	3	R	3	0.02				●							19.45	5	0°	6°
DGS3-002-6L	3	L	3	0.02				●							19.45	5	6°	0°
DGS3-020-15R	3	R	3	0.2		●	●		●						20	5	0°	15°
DGS3-020-15L	3	L	3	0.2		●	●		●						20	5	15°	0°
DGS3-002-15R	3	R	3	0.02				●							19.45	5	0°	15°
DGS3-002-15L	3	L	3	0.02				●							19.45	5	15°	0°
DGS3.18-020	3	N	3.18	0.2		●		●		●					20	5	0°	0°
DGS4-030	4	N	4	0.3	●	●	●	●	●	●	●	●	●		20	5	0°	0°
DGS4-030-4R	4	R	4	0.3		●	●		●						20	5	0°	4°
DGS4-030-4L	4	L	4	0.3		●	●		●						20	5	4°	0°
DGS4.76-040	5	N	4.76	0.4		●		●		●					25	5.5	0°	0°
DGS5-030	5	N	5	0.3	●	●	●	●	●	●	●	●	●		25	5.5	0°	0°
DGS6-030	6	N	6	0.3	●	●	●	●	●	●	●	●	●		25	5.5	0°	0°
DGS6.35-040	6	N	6.35	0.4		●		●		●					25	5.5	0°	0°
DGS8-040	8	N	8	0.4		●		●		●			●		30	6.7	0°	0°

● : Line up

Caution

The tool will interfere with the workpiece when grooving larger diameters than øDmax.

Designation	øDmax (mm)	Designation	øDmax (mm)
DGM2-002-15R/L	28	DGS2-002-15R/L	28
DGM3-002-15R/L	29	DGS3-002-15R/L	29
DGM4-030-15R/L	30	SGS3-020-15R/L	103
SGM3-020-15R/L	103	SGS3-002-15R/L	34

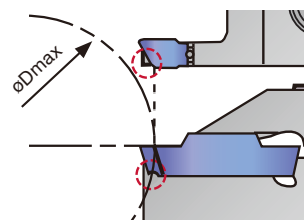

Reference pages: Toolholders → F229 - F235, Standard cutting conditions → F246

External deep grooving and parting

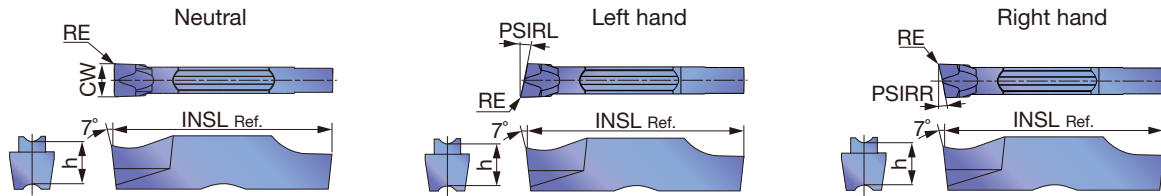

P	Steel	★	☆	★	☆	★								
M	Stainless	★	☆	★	★	★								
K	Cast iron	★		★	☆	★		☆						
N	Non-ferrous							☆						
S	Superalloys	★	☆	★				★						
H	Hard materials													

★ : First choice
☆ : Second choice

Designation	Seat size	HAND	CW±0.05	RE	Coated					Uncoated					INSL	h	PSIRL	PSIRR
					AH7025	AH725	AH8005	GH130	AH6235	KS05F								
SGS2-020	2	N	2	0.2	●	●	●	●	●	●					20	5	0°	0°
SGS2-020-6R	2	R	2	0.2	●	●	●	●							20	5	0°	6°
SGS2-020-6L	2	L	2	0.2	●	●	●	●							20	5	6°	0°
SGS2-020-15R	2	R	2	0.2	●	●	●	●							20	5	0°	15°
SGS2-020-15L	2	L	2	0.2	●	●	●	●							20	5	15°	0°
SGS3-020	3	N	3	0.2	●	●	●	●	●	●					20	5	0°	0°
SGS3-020-6R	3	R	3	0.2	●	●	●	●							20	5	0°	6°
SGS3-020-6L	3	L	3	0.2	●	●	●	●							20	5	6°	0°
SGS3-002-6R	3	R	3	0.02		●	●	●							19.8	5	0°	6°
SGS3-002-6L	3	L	3	0.02		●	●	●							19.8	5	6°	0°
SGS3-020-15R	3	R	3	0.2	●	●	●	●							20	5	0°	15°
SGS3-020-15L	3	L	3	0.2	●	●	●	●							20	5	15°	0°
SGS3-002-15R	3	R	3	0.02		●	●	●							19.8	5	0°	15°
SGS3-002-15L	3	L	3	0.02		●	●	●							19.8	5	15°	0°
SGS4-030	4	N	4	0.3	●	●	●	●	●	●					20	5	0°	0°
SGS5-030	5	N	5	0.3	●	●	●	●	●	●					25	5.5	0°	0°
SGS6-030	6	N	6	0.3	●	●	●	●	●	●					25	5.5	0°	0°
SGS8-040	8	N	8	0.4	●	●	●	●							30	6.7	0°	0°

● : Line up

DGG

External grooving and parting (for high precision)

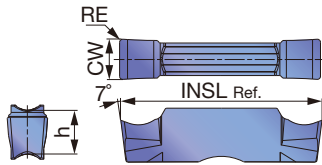

P	Steel	★		★							
M	Stainless	★									
K	Cast iron	★		☆		☆					
N	Non-ferrous						★				
S	Superalloys	★					☆				
H	Hard materials										

★ : First choice
☆ : Second choice

Designation	Seat size	CW±0.02	RE	Coated			Cermet			Uncoated			INSL	h
				AH7025			NS9530			KS05F				
DGG200-020	2	2	0.2	●			●			●			20	5
DGG300-020	3	3	0.2	●			●			●			20	5
DGG400-040	4	4	0.4	●			●			●			20	5
DGG500-040	5	5	0.4	●			●			●			25	5.5
DGG600-040	6	6	0.4	●			●			●			25	5.5

● : Line up

DGL

External grooving and parting

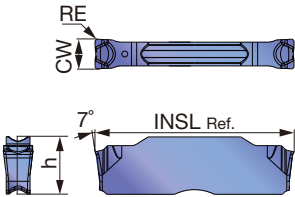

P	Steel	★	★	★							
M	Stainless	★	★	★							
K	Cast iron	★	★	★							
N	Non-ferrous										
S	Superalloys	★	★								
H	Hard materials										

★ : First choice
☆ : Second choice

Designation	Seat size	CW±0.05	RE	Coated			Cermet			Uncoated			INSL	h
				AH7025	AH8005	AH6235								
DGL2-020	2	2	0.2	●	●	●							20	5
DGL3-025	3	3	0.25	●	●	●							20	5
DGL4-030	4	4	0.3	●	●	●							20	5
DGL5-030	5	5	0.3	●	●	●							25	5.5
DGL6-080	6	6	0.8	●	●	●							25	5.5

● : Line up

Reference pages: Toolholders → **F229 - F235**, Standard cutting conditions → **F246**



DTM

External/face grooving, turning and parting

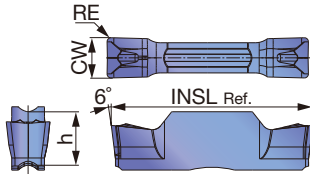

P Steel	★	★	★							
M Stainless	★	★	★							
K Cast iron	★	★	★							
N Non-ferrous										
S Superalloys	★	★								
H Hard materials										

★ : First choice
☆ : Second choice

Designation	Seat size	CW±0.05	RE	Coated			INSL	h
				AH7025	AH8005	AH6235		
DTM2-020	2	2	0.2	●	●	●	20	5
DTM3-030	3	3	0.3	●	●	●	20	5
DTM4-040	4	4	0.4	●	●	●	20	5
DTM4-080	4	4	0.8	●	●	●	20	5
DTM5-080	5	5	0.8	●	●	●	25	5.5
DTM6-080	6	6	0.8	●	●	●	25	5.5
DTM8-080	8	8	0.8	●	●	●	30	6.7

● : Line up

DTE

External/face grooving, turning and parting (for high precision)

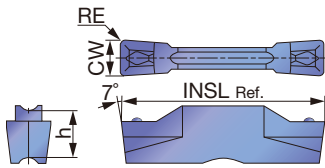

P Steel	★	★	☆	☆				★		
M Stainless	★	★	☆	★						
K Cast iron	★	★	☆	☆						
N Non-ferrous										
S Superalloys	★	☆								
H Hard materials										

★ : First choice
☆ : Second choice

Designation	Seat size	CW±0.02	RE	Coated				Cermet	INSL	h
				T9225	AH7025	AH725	GH130	NS9530		
DTE265-015	3	2.65	0.15	●	●	●	●	●	20	5
DTE300-020	3	3	0.2	●	●	●	●	●	20	5
DTE300-040	3	3	0.4	●	●	●	●	●	20	5
DTE315-015	3	3.15	0.15	●	●	●	●	●	20	5
DTE400-040	4	4	0.4	●	●	●	●	●	20	5
DTE400-080	4	4	0.8	●	●	●	●	●	20	5
DTE415-015	4	4.15	0.15	●	●	●	●	●	20	5
DTE478-055	5	4.78	0.55	●	●	●	●	●	25	5.5
DTE500-040	5	5	0.4	●	●	●	●	●	25	5.5
DTE500-080	5	5	0.8	●	●	●	●	●	25	5.5
DTE515-015	5	5.15	0.15	●	●	●	●		25	5.5
DTE600-080	6	6	0.8	●	●	●	●		25	5.5
DTE600-120	6	6	1.2	●	●	●	●		25	5.5
DTE800-080	8	8	0.8	●	●	●	●		30	6.7
DTE800-120	8	8	1.2	●	●	●	●		30	6.7

● : Line up

Reference pages: Toolholders → **F229 - F235**, Standard cutting conditions → **F246**

DTE

External/face grooving, turning and parting

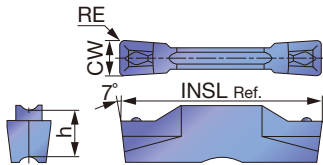

P Steel	★		★	☆	★	☆	★		★				
M Stainless			★	☆	★	★	★						
K Cast iron		★	★		★	☆	★						
N Non-ferrous													
S Superalloys			★	☆	★								
H Hard materials													

★ : First choice
☆ : Second choice

Designation	Seat size	CW±0.05	RE	Coated						Cermet		INSL	h
				T9225	T515	AH7025	AH725	AH8005	GH130	AH6235	NS9530		
DTE3-020	3	3	0.2			●		●		●		20	5
DTE3-040	3	3	0.4	●	●	●	●	●	●	●		20	5
DTE4-040	4	4	0.4	●	●	●	●	●	●	●		20	5
DTE4-080	4	4	0.8			●		●		●		20	5
DTE5-040	5	5	0.4		●	●		●		●		25	5.5
DTE5-080	5	5	0.8			●		●		●		25	5.5
DTE6-080	6	6	0.8		●	●		●		●		25	5.5

● : Line up

DTX

External/internal/face grooving, turning and parting

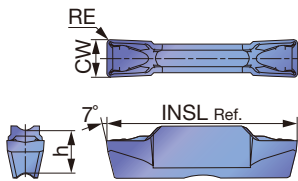

P Steel	★	★	☆	★	☆	★		★					
M Stainless		★	☆	★	★	★							
K Cast iron		★		★	☆	★		☆			☆		
N Non-ferrous											☆		
S Superalloys		★	☆	★							★		
H Hard materials													

★ : First choice
☆ : Second choice

Designation	Seat size	CW±0.05	RE	Coated						Cermet		Uncoated		INSL	h
				T9225	AH7025	AH725	AH8005	GH130	AH6235	NS9530		KS05F			
DTX2-020	2	2	0.2		●		●		●			●		20	5
DTX3-030	3	3	0.3	●	●	●	●	●	●	●		●		20	5
DTX4-040	4	4	0.4	●	●	●	●	●	●	●		●		20	5
DTX5-040	5	5	0.4	●	●	●	●	●	●	●		●		25	5.5
DTX6-080	6	6	0.8		●	●	●	●	●			●		25	5.5
DTX8-080	8	8	0.8		●		●		●			●		30	6.7

● : Line up

Reference pages: Toolholders → **F229 - F235**, Standard cutting conditions → **F246**

STANDARD CUTTING CONDITIONS

ISO	Workpiece material	Hardness	Priority	Grade	Cutting speed Vc (m/min)
P	Steel S45C, SCM435, etc. C45, 34CrMo4, etc.	< 300 HB	First choice	AH7025, AH725	50 - 180
		< 300 HB	Wear resistance	T9225, AH8005	80 - 300
		< 300 HB	Impact resistance	AH6235, GH130	50 - 120
		< 300 HB	Surface quality	NS9530	80 - 220
M	Stainless steel SUS303, SUS304, etc. X10CrNiS18-9, X5CrNi18-9, etc.	< 200 HB	First choice	AH7025, AH725	50 - 120
		< 200 HB	Wear resistance	AH8005	50 - 120
		< 200 HB	Impact resistance	AH6235, GH130	50 - 120
K	Grey cast iron FC250, etc. 250, etc.	-	First choice	T515	150 - 700
		-	Impact resistance	AH8005, AH7025, AH6235, GH130	50 - 180
	Ductile cast iron FCD450, etc. 450-10S, etc.	-	First choice	T515	150 - 300
		-	Impact resistance	AH8005, AH7025, AH6235, GH130	50 - 120
N	Aluminium alloys Si < 12%	-	First choice	TH10	100 - 500
		-	First choice	KS05F	100 - 600
S	Superalloys Inconel718, etc.	< HRC 40	First choice	AH8005	20 - 60
		< HRC 40	Impact resistance	AH7025, AH725, AH6235	20 - 40
	Titanium alloys Ti-6Al-4V, etc.	< HRC 40	First choice	KS05F	20 - 100
		< HRC 40	Impact resistance	AH7025, AH725	20 - 80

Please see page **F236**, **F237** for feed: f (mm/rev).

STH

ISO	Grade	CW	Application	Cutting speed Vc (m/min)	Depth of cut ap (mm)	Feed f (mm/rev)
H	BXA10	3	External turning	100 - 230	0.08 - 0.12	0.4 - 1
			Face turning	100 - 230	0.08 - 0.12	0.4 - 0.8
		5	External turning	100 - 230	0.08 - 0.12	0.5 - 1.5
			Face turning	100 - 230	0.08 - 0.12	0.5 - 0.8

SGN

ISO	Grade	Edge preparation	Workpiece condition	Cutting speed Vc (m/min)	Feed f (mm/rev)
H	BX360	No symbol	Continuous	80 - 150	0.03 - 0.08
		-S	Light interrupted	50 - 120	0.03 - 0.08
		-H	Heavy interrupted	40 - 100	0.03 - 0.06

Parting-off and grooving toolholders

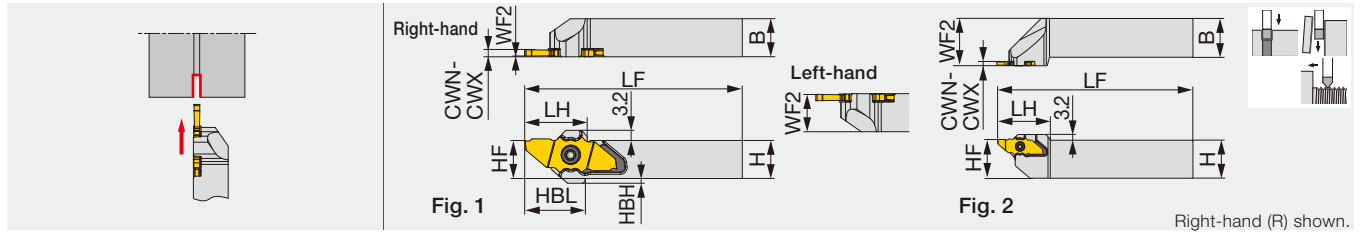

Designation	CWN	CWX	H	B	LF ⁽¹⁾	LH ⁽¹⁾	HF	WF2 ⁽²⁾	HBL ⁽¹⁾	HBH	Insert	Torque*	Fig.
JSXXR/L1010X09	0.6	2.5	10	10	120	19.65	10	0.2/9.8	19	3	JX**06...,12...,16..., 20...	1.2	1
JSXXR/L1212F09	0.6	2.5	12	12	85	19.65	12	0.2/11.8	19	1.5	JX**06...,12...,16..., 20...	1.2	1
JSXXR/L1212X09	0.6	2.5	12	12	120	19.65	12	0.2/11.8	19	1.5	JX**06...,12...,16..., 20...	1.2	1
JSXXR/L1616X09	0.6	2.5	16	16	120	19.65	16	0.2/15.8	-	-	JX**06...,12...,16..., 20...	1.2	1
JSXXR/L2020H09	0.6	2.5	20	20	100	22.5	20	0.2/19.8	-	-	JX**06...,12...,16..., 20...	1.2	1
JSXXR/L2525Z09	0.6	2.5	25	25	135	34	25	30	-	-	JX**06...,12...,16..., 20...	1.2	2

*Torque: Recommended clamping torque (N·m)

(1) LF (Functional Length) LH (Head Length), and HBL (Head-bottom Offset Length) values shown above are true with JX**16... insert. LF, LH, and HBL will all be 2 mm shorter than the above values with JX**12... and JX**20... inserts, and 4 mm shorter for JX**06... insert.

(2) The first value before "/" indicates the WF2 for the right-hand holder and the second value after "/" for the left-hand holder.

Note: Use the right-hand insert (JX***R...) for a right-hand holder (JSXXR...); the left-hand insert (JX***L...) for a left-hand holder (JSXXL...).

JSXXR/L-F/H/X-CHP

Parting-off toolholders with high pressure coolant capability, for swiss lathes

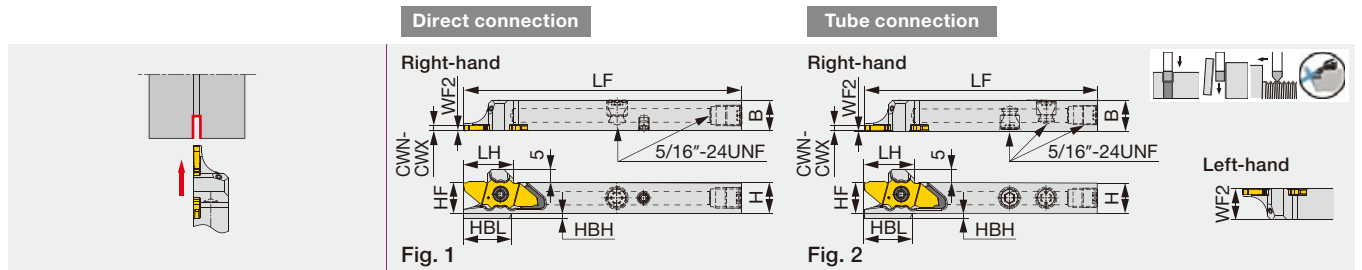

Designation	CWN	CWX	H	B	LF ⁽¹⁾	LH ⁽¹⁾	HF	WF2 ⁽²⁾	HBL ⁽¹⁾	HBH	Insert	Torque*	Fig.
JSXXR/L1012H09-CHP ⁽³⁾	0.6	2.5	10	12	102	19.2	10	0.2/11.8	18.7	3	JX**06...,12...,16..., 20...	1.2	1
JSXXR/L1212F09-CHP	0.6	2.5	12	12	85	19.4	12	0.2/11.8	18.8	2	JX**06...,12...,16..., 20...	1.2	2
JSXXR/L1212X09-CHP ⁽³⁾	0.6	2.5	12	12	120	19.4	12	0.2/11.8	18.8	2	JX**06...,12...,16..., 20...	1.2	1
JSXXR/L1616X09-CHP ^{(3),(4)}	0.6	2.5	16	16	120	19.4	16	0.2	18.7	2.5	JX**06...,12...,16..., 20...	1.2	1
JSXXR/L1616X09B-CHP ⁽³⁾	0.6	2.5	16	16	120	19.4	16	0.2/15.8	18.7	-	JX**06...,12...,16..., 20...	1.2	1

*Torque: Recommended clamping torque (N·m)

(1) LF (Functional Length) LH (Head Length), and HBL (Head-bottom Offset Length) values shown above are true with JX**16... insert. LF, LH, and HBL will all be 2 mm shorter than the above values with JX**12... and JX**20... inserts, and 4 mm shorter for JX**06... insert.

(2) The first value before "/" indicates the WF2 for the right-hand holder and the second value after "/" for the left-hand holder.

(3) Compatible to the direct internal coolant supply system without the use of external coolant hose.

(4) To be replaced with the new design

Note: Use the right-hand insert (JX***R...) for a right-hand holder (JSXXR...); the left-hand insert (JX***L...) for a left-hand holder (JSXXL...).

SPARE PARTS

Designation	Clamping screw	Wrench 1	Coolant plug	Wrench 2	DirectJet plug	Wrench 3
JSXXR**09	CSTC-4L100DL	T-1008/5	-	-	-	-
JSXXL**09	CSTC-4L100DR	T-1008/5	-	-	-	-
JSXXR**F**-CHP	CSTC-4L100DL	T-1008/5	SR5/16UNFTL360	P-4	-	-
JSXXL**F**-CHP	CSTC-4L100DR	T-1008/5	SR5/16UNFTL360	P-4	-	-
JSXXR**H/X**-CHP	CSTC-4L100DL	T-1008/5	SR5/16UNFTL360	P-4	SSHM4-6-TB	P-2
JSXXL**H/X**-CHP	CSTC-4L100DR	T-1008/5	SR5/16UNFTL360	P-4	SSHM4-6-TB	P-2



Parting-off toolholders, for swiss lathes (for sub spindle)

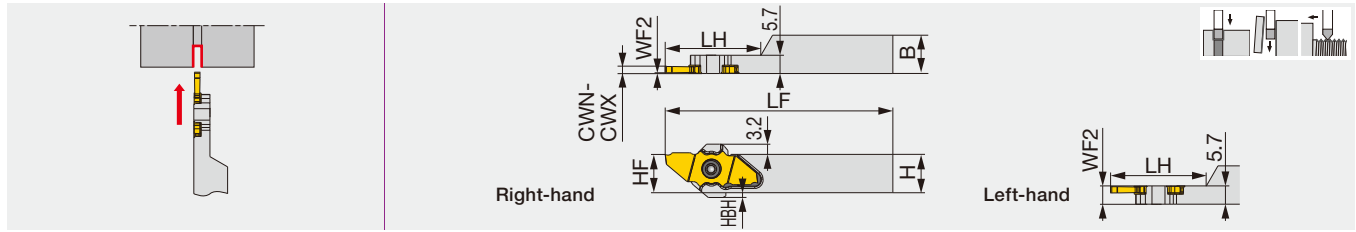

Designation	CWN	CWX	H	B	LF ⁽¹⁾	LH ⁽¹⁾	HF	WF2 ⁽²⁾	HBH	Insert	Torque*
JSXXR/L1010X09-S	0.6	2.5	10	10	120	26	10	0.2/5.5	3	JX**06...,12...,16... ⁽³⁾	1.2
JSXXR/L1212F09-S	0.6	2.5	12	12	85	26	12	0.2/5.5	1.5	JX**06...,12...,16... ⁽³⁾	1.2
JSXXR/L1212X09-S	0.6	2.5	12	12	120	30	12	0.2/5.5	1.5	JX**06...,12...,16... ⁽³⁾	1.2
JSXXR/L1616X09-S	0.6	2.5	16	16	120	30	16	0.2/5.5	-	JX**06...,12...,16...,20...	1.2

*Torque: Recommended clamping torque (N-m)
 (1) LF (Functional Length) and LH (Head Length) values shown above are true with JX**16... insert. Both LF and LH will be 2 mm shorter than the above value with JX**12... and JX**20... inserts; 4 mm shorter with JX**06... insert.
 (2) The first value before "/" indicates the WF2 for the right-hand holder and the second value after "/" for the left-hand holder.
 (3) JX**20... insert will not fit.
 Note: Use the right-hand insert (JX****R...) for a right-hand holder (JSXXR...); the left-hand insert (JX****L...) for a left-hand holder (JSXXL...).

- External
- Internal
- Face
- Parting
- Others

JSXXR/L-F/X-S-CHP

Parting-off toolholders with high pressure coolant capability, for swiss lathes (for sub spindle)

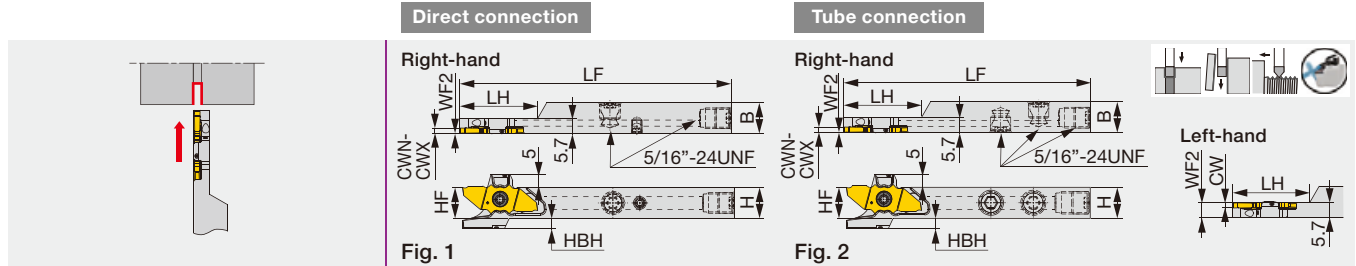

Designation	CWN	CWX	H	B	LF ⁽¹⁾	LH ⁽¹⁾	HF	WF2 ⁽²⁾	HBH	Insert	Torque*	Fig.
JSXXR/L1212F09-S-CHP ⁽⁴⁾	0.6	2.5	12	12	85	26	12	0.2	4	JX**06...,12...,16...,20...	1.2	2
JSXXR/L1212F09B-S-CHP	0.6	2.5	12	12	85	30	12	0.2/5.5	2	JX**06...,12...,16...,20...	1.2	2
JSXXR/L1212X09-S-CHP ^{(3),(4)}	0.6	2.5	12	12	120	30	12	0.2/5.5	4	JX**06...,12...,16...,20...	1.2	1
JSXXR/L1212X09B-S-CHP ⁽³⁾	0.6	2.5	12	12	120	30	12	0.2/5.5	2	JX**06...,12...,16...,20...	1.2	1
JSXXR/L1616X09-S-CHP ^{(3),(4)}	0.6	2.5	16	16	120	30	16	0.2	1.5	JX**06...,12...,16...,20...	1.2	1
JSXXR/L1616X09B-S-CHP ⁽³⁾	0.6	2.5	16	16	120	30	16	0.2/5.5	-	JX**06...,12...,16...,20...	1.2	1

*Torque: Recommended clamping torque (N-m)
 (1) LF (Functional Length) and LH (Head Length) values shown above are true with JX**16... insert. Both LF and LH will be 2 mm shorter than the above value with JX**12... and JX**20... inserts; 4 mm shorter with JX**06... insert.
 (2) The first value before "/" indicates the WF2 for the right-hand holder and the second value after "/" for the left-hand holder.
 (3) Compatible to the direct internal coolant supply system without the use of external coolant hose.
 (4) To be replaced with the new design
 Note: Use the right-hand insert (JX****R...) for a right-hand holder (JSXXR...); the left-hand insert (JX****L...) for a left-hand holder (JSXXL...).

SPARE PARTS

Designation	Clamping screw	Wrench 1	Coolant plug	Wrench 2	DirectJet plug	Wrench 3
JSXXR**-S	CSTC-4L055DL	T-1008/5	-	-	-	-
JSXXL**-S	CSTC-4L055DR	T-1008/5	-	-	-	-
JSXXR**F**-S-CHP	CSTC-4L055DL	T-1008/5	SR5/16UNFTL360	P-4	-	-
JSXXL**F**-S-CHP	CSTC-4L055DR	T-1008/5	SR5/16UNFTL360	P-4	-	-
JSXXR**X**-S-CHP	CSTC-4L055DL	T-1008/5	SR5/16UNFTL360	P-4	SSH4-6-TB	P-2
JSXXL**X**-S-CHP	CSTC-4L055DR	T-1008/5	SR5/16UNFTL360	P-4	SSH4-6-TB	P-2

Reference pages: Inserts → **F249, F250**, Standard cutting conditions → **F251**
 Parts for coolant hose → **F266**

INSERTS

JXPS**R/L-F (with 3D chipbreaker, sharp edge)

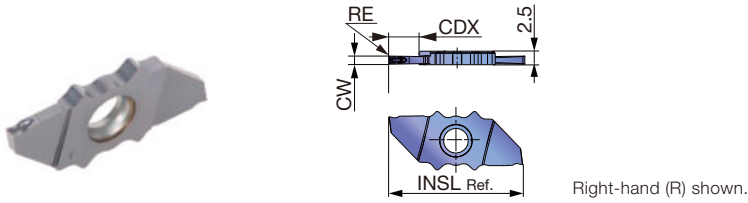

Right-hand (R) shown.

P	Steel	★						
M	Stainless	★						
K	Cast iron	★						
N	Non-ferrous							
S	Superalloys	★						
H	Hard materials							

★ : First choice

Designation	HAND	CW±0.025	RE	Coated				CUTDIA	CDX*	INSL
				SH725						
JXPS06R06F	R	0.6	0.05	●				6	3.5	21
JXPS06L06F	L	0.6	0.05	●				6	3.5	21
JXPS12R08F	R	0.8	0.05	●				12	6.5	25
JXPS12L08F	L	0.8	0.05	●				12	6.5	25
JXPS12R10F	R	1	0.05	●				12	6.5	25
JXPS12L10F	L	1	0.05	●				12	6.5	25
JXPS12R15F	R	1.5	0.05	●				12	6.5	25
JXPS12L15F	L	1.5	0.05	●				12	6.5	25
JXPS16R15F	R	1.5	0.05	●				16	8.5	29
JXPS16L15F	L	1.5	0.05	●				16	8.5	29
JXPS20R20F	R	2	0.05	●				20	10.5	33
JXPS20L20F	L	2	0.05	●				20	10.5	33

*Max grooving depth (CDX) varies depending on workpiece diameters.

● : Line up

Grade
Insert
Ext. Toolholder
Int. Toolholder
Threading
Grooving
Miniature tool
Milling cutter
Endmill
Drilling tool
Tooling System
User's Guide
Index



JXPGR/L-F (Sharp edge)**

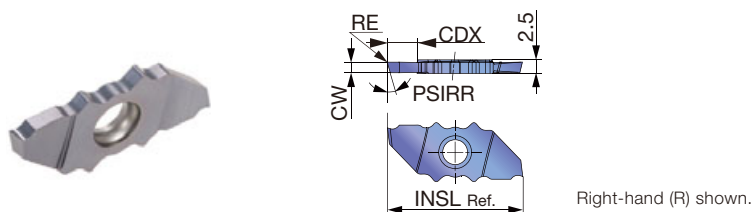

P	Steel	★						
M	Stainless	★						
K	Cast iron	★						
N	Non-ferrous							
S	Superalloys	★						
H	Hard materials							

★ : First choice



Designation	HAND	CW±0.025	RE	Coated				CUTDIA	CDX*	INSL	PSIRR
				SH725							
JXPG06R10F	R	1	0.05	●				6	3.5	21	0°
JXPG06L10F	L	1	0.05	●				6	3.5	21	0°
JXPG06R15F	R	1.5	0.05	●				6	3.5	21	0°
JXPG06L15F	L	1.5	0.05	●				6	3.5	21	0°
JXPG06R10F-15	R	1	0.05	●				6	3.5	21	15°
JXPG06L10F-15	L	1	0.05	●				6	3.5	21	15°
JXPG06R15F-15	R	1.5	0.05	●				6	3.5	21	15°
JXPG06L15F-15	L	1.5	0.05	●				6	3.5	21	15°
JXPG12R15F	R	1.5	0.05	●				12	6.5	25	0°
JXPG12L15F	L	1.5	0.05	●				12	6.5	25	0°
JXPG12R20F	R	2	0.05	●				12	6.5	25	0°
JXPG12L20F	L	2	0.05	●				12	6.5	25	0°
JXPG12R15F-15	R	1.5	0.05	●				12	6.5	25	15°
JXPG12L15F-15	L	1.5	0.05	●				12	6.5	25	15°
JXPG12R20F-15	R	2	0.05	●				12	6.5	25	15°
JXPG12L20F-15	L	2	0.05	●				12	6.5	25	15°
JXPG16R15F	R	1.5	0.05	●				16	8.5	29	0°
JXPG16L15F	L	1.5	0.05	●				16	8.5	29	0°
JXPG16R20F	R	2	0.05	●				16	8.5	29	0°
JXPG16L20F	L	2	0.05	●				16	8.5	29	0°
JXPG16R15F-15	R	1.5	0.05	●				16	8.5	29	15°
JXPG16L15F-15	L	1.5	0.05	●				16	8.5	29	15°
JXPG16R20F-15	R	2	0.05	●				16	8.5	29	15°
JXPG16L20F-15	L	2	0.05	●				16	8.5	29	15°
JXPG20R15F	R	1.5	0.05	●				20	10.5	33	0°
JXPG20L15F	L	1.5	0.05	●				20	10.5	33	0°
JXPG20R20F	R	2	0.05	●				20	10.5	33	0°
JXPG20L20F	L	2	0.05	●				20	10.5	33	0°
JXPG20R15F-15	R	1.5	0.05	●				20	10.5	33	15°
JXPG20L15F-15	L	1.5	0.05	●				20	10.5	33	15°
JXPG20R20F-15	R	2	0.05	●				20	10.5	33	15°
JXPG20L20F-15	L	2	0.05	●				20	10.5	33	15°

*Max grooving depth (CDX) varies depending on workpiece diameters.

● : Line up

Reference pages: Toolholders → **F247, F248**

STANDARD CUTTING CONDITIONS

Parting, Grooving

ISO	Workpiece materials	Grades	Cutting speed Vc (m/min)	Feed f (mm/rev)
P	Low carbon steels S15C, SS400, etc. C15E4, E275A, etc.	SH725	50 - 200	0.01 - 0.05
	Carbon steels, Alloy steels S55C, SCM440, etc. C55, 42CrMo4, etc.	SH725	50 - 200	0.01 - 0.05
	Free cutting steels SUH22, SUH23, etc.	SH725	50 - 200	0.01 - 0.05
M	Stainless steels SUS304, X5CrNi18-9, etc.	SH725	50 - 200	0.01 - 0.05
N	Aluminium alloys A5056, A6061, etc.	SH725	150 - 200	0.01 - 0.05
	Copper alloy C2600, C280C, etc.	SH725	100 - 200	0.01 - 0.05
S	Titanium alloys Ti-6Al-4V, etc.	SH725	30 - 80	0.01 - 0.05
	Superalloys Inconel718, etc.	SH725	30 - 80	0.01 - 0.05

Grade

Insert

Ext. Toolholder

Int. Toolholder

Threading

Grooving

Miniature tool

Milling cutter

Endmill

Drilling tool

Tooling System

User's Guide

Index



MY-T SERIES

CCH-W

External grooving and parting blade, for 2 corner inserts

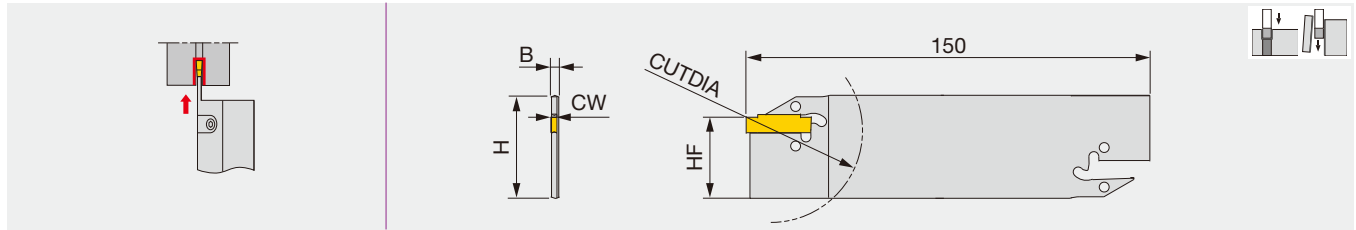

Designation	CW	CUTDIA	H	B	HF	Insert
CCH32-W20	2	33	32	1.6	24.6	WGE20, WGE20R/L
CCH32-W30	3	33	32	2.2	24.6	WG*30, WGE30R/L
CCH32-W40	4	42	32	3.2	24.5	WG*40, WGE40R/L
CCH32-W50	5	42	32	4.2	24.3	WG*50, WGE50R/L

SPARE PARTS

Designation	Wrench (Optional)
CCH32-W...	CRW33

CCBS-32

Tool block for CCH blade

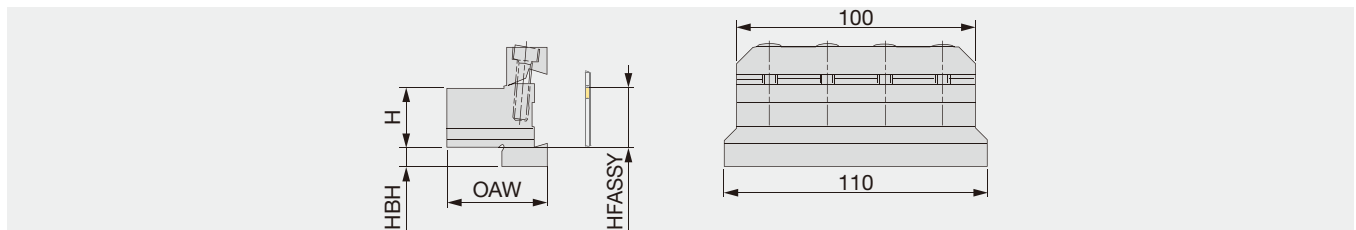

Designation	H	HFASSY	HBH	OAW	Blade
CCBS20-32	20	20	13	38	CCH32...
CCBS25-32	25	25	8	42	CCH32...
CCBS32-32	32	32	5	42	CCH32...

SPARE PARTS

Designation	Clamp	Screw	Wrench
CCBS*-32	CC-32	CM6X25	P-5

Reference pages: Inserts → **F253 - F255**, Standard cutting conditions → **F255**

CHIPBREAKER GUIDE (for 2 corner inserts)

External grooving and parting

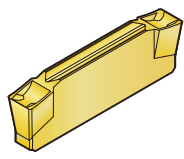
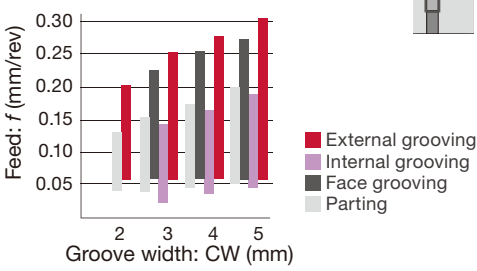
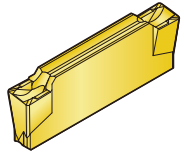
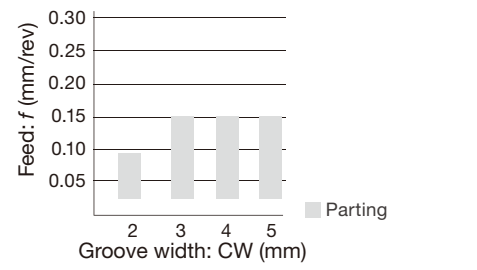
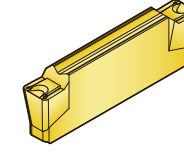
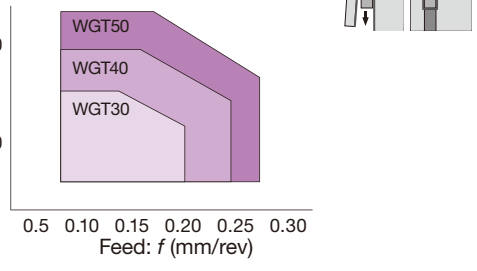
<p>WGE</p>  <p>F254</p>	<p>1st choice for external grooving and parting Excellent chip control for grooving CW = 2 - 5 mm</p>	 <p>Feed: f (mm/rev)</p> <p>Groove width: CW (mm)</p> <ul style="list-style-type: none"> External grooving Internal grooving Face grooving Parting
<p>WGE R/L</p>  <p>F255</p>	<p>Handed insert Minimize burr generation when workpiece is cut off CW = 2 - 5 mm</p>	 <p>Feed: f (mm/rev)</p> <p>Groove width: CW (mm)</p> <ul style="list-style-type: none"> Parting
<p>WGT</p>  <p>F254</p>	<p>1st choice for turning Low cutting force and good chip control for traversing CW = 3 - 5 mm</p>	 <p>Depth of cut a_p (mm)</p> <p>Feed: f (mm/rev)</p> <ul style="list-style-type: none"> WGT50 WGT40 WGT30

Please see page F*** for the product details.

INSERTS (2 corners)

WGE

For external grooving and parting



P	Steel	★	★	★				★					
M	Stainless		★	★									
K	Cast iron		★	☆				☆					
N	Non-ferrous												
S	Superalloys			☆									
H	Hard materials												

★ : First choice
☆ : Second choice

Designation	CW ^{+0.1} ₀	RE	Coated			Cermet			INSL	h
			T9225	AH120	GH730	NS9530				
WGE20	2	0.2	●	●	●		●		20	4.7
WGE30	3	0.2	●	●	●		●		20	5.5
WGE40	4	0.2	●	●	●		●		25	5.7
WGE50	5	0.2	●	●	●		●		25	5.9

● : Line up

WGT

For external grooving, parting and turning

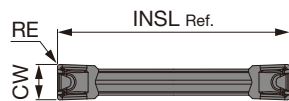

P	Steel	★	★	★				★					
M	Stainless		★	★	★								
K	Cast iron		☆	★	☆			☆					
N	Non-ferrous												
S	Superalloys			☆									
H	Hard materials												

★ : First choice
☆ : Second choice

Designation	CW ^{+0.1} ₀	RE	Coated			Cermet			INSL	h
			T9225	AH120	GH730	NS9530				
WGT30	3	0.4	●		●		●		20	5.5
WGT40	4	0.4	●		●		●		25	5.7
WGT50	5	0.4	●	●	●		●		25	5.9

● : Line up

Reference pages: Toolholders → **F252**

WGE(R/L)

For parting off (handed inserts)

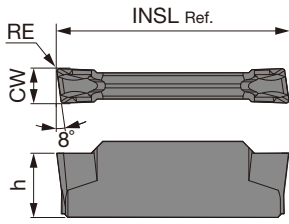

Right hand (R) shown.

P	Steel	★	★						
M	Stainless	★	★						
K	Cast iron	★	☆						
N	Non-ferrous								
S	Superalloys	☆							
H	Hard materials								

★ : First choice
☆ : Second choice

Designation	HAND	CW ^{+0.1}	RE	Coated		INSL	h
				AH120	GH730		
WGE20R	R	2	0.2	●		20	4.7
WGE20L	L	2	0.2	●		20	4.7
WGE30R	R	3	0.2	●		20	5.5
WGE30L	L	3	0.2	●		20	5.5
WGE40R	R	4	0.2	●		25	5.7
WGE40L	L	4	0.2	●		25	5.7
WGE50R	R	5	0.2	●		25	5.9
WGE50L	L	5	0.2	●		25	5.9

● : Line up

STANDARD CUTTING CONDITIONS (for 2 corner inserts)

ISO	Workpiece material	Recommended grade	Cutting speed V _c (m/min)
P	Low carbon steels Alloy steels (~ HB150)	T9225	80 - 300
		NS9530	100 - 200
		GH730, AH120	50 - 180
	Medium carbon steels Alloy steels (HB150 ~ 250)	T9225	80 - 220
		NS9530	80 - 180
		GH730, AH120	50 - 150
High carbon steels Alloy steels (HB250 ~)	T9225	80 - 220	
	NS9530	80 - 150	
	GH730, AH120	50 - 150	
M	Stainless steels	GH730, AH120	50 - 120
K	Grey and ductile cast irons	GH730, AH120	50 - 180

Operation	Feed: f (mm/rev)			
	Groove width: CW (mm)			
	2	3	4	5
Grooving (WGE□□)	0.06 ~ 0.20	0.06 ~ 0.25	0.07 ~ 0.27	0.07 ~ 0.30
Parting-off (WGE□□R/L)	0.04 ~ 0.10	0.04 ~ 0.14	0.04 ~ 0.14	0.04 ~ 0.14
Turning (WGT□□)	-	ap = 0.5 ~ 1.5 f = 0.06 ~ 0.2	ap = 0.5 ~ 2.0 f = 0.06 ~ 0.25	ap = 0.5 ~ 2.5 f = 0.06 ~ 0.27



MY-T SERIES

CCH

External grooving and parting blade, for 1 corner inserts

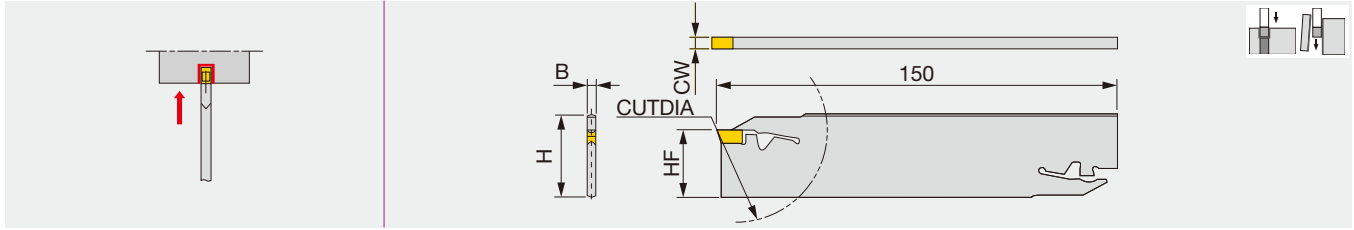

Designation	CW	CUTDIA	H	B	HF	Insert
CCH32-30	3	100	32	2.2	24.6	GE30,GE30R/L,GE30-AL
CCH32-40	4	100	32	3.2	24.5	GE40,GE40R/L,GE40-AL
CCH32-50	5	120	32	4.2	24.3	GE50,GE50R/L,GE50-AL

SPARE PARTS

Designation	Wrench
CCH32-...	CTL-2

CCBS-32

Tool block for CCH blade

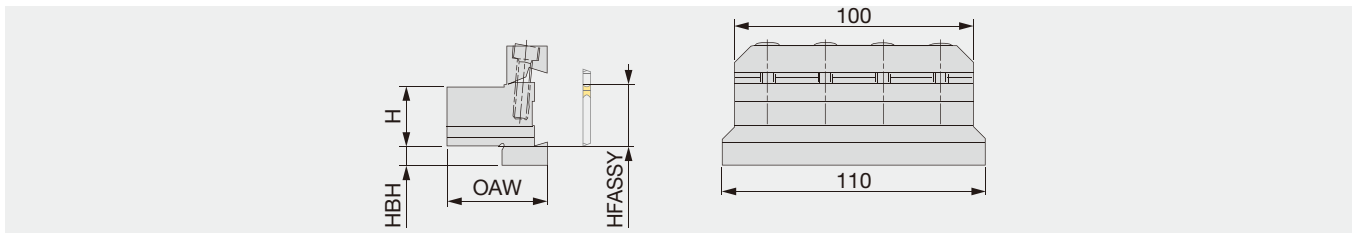

Designation	H	HFASSY	HBH	OAW	Blade
CCBS20-32	20	20	13	38	CCH32...
CCBS25-32	25	25	8	42	CCH32...
CCBS32-32	32	32	5	42	CCH32...

SPARE PARTS

Designation	Clamp	Screw	Wrench
CCBS*-32	CC-32	CM6X25	P-5





Reference pages: Inserts → [F257 - F261](#), Standard cutting conditions → [F261](#)

CHIPBREAKER GUIDE (for 1 corner inserts)

Grade
Insert
Ext. Toolholder
Int. Toolholder
Threading
Grooving
Miniature tool
Milling cutter
Endmill
Drilling tool
Tooling System
User's Guide
Index

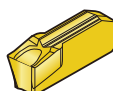
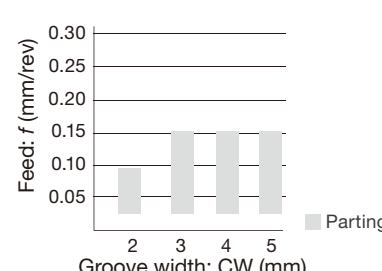
A
B
C
D
E
F
G
H
I
J
K
L
M

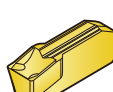
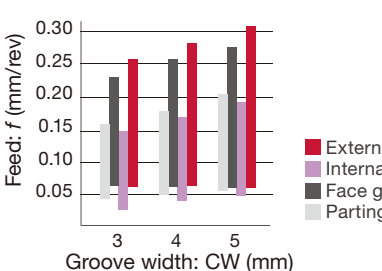
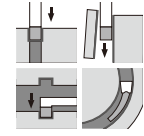
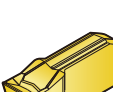
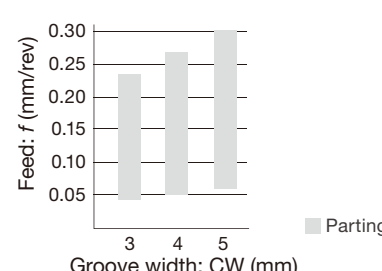
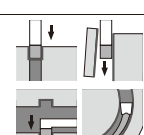
External grooving and parting

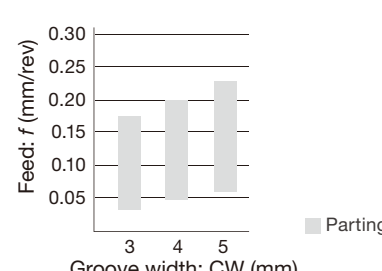
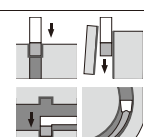
<p>GE R/L</p>  <p>F258</p>	<p>Handed insert Minimize burr generation when workpiece is cut off CW = 3 - 5 mm</p>	 
<p>GE</p>  <p>F259</p>	<p>1st choice for external grooving and parting Excellent chip control for grooving CW = 3 - 5 mm</p>	 
<p>GF</p>  <p>F259</p>	<p>1st choice for face grooving Low cutting force and good chip control for face grooving CW = 3 - 5 mm</p>	 
<p>GN</p>  <p>F260</p>	<p>1st choice for internal grooving Low cutting force and good chip control for internal grooving CW = 3 - 5 mm</p>	 

External grooving and turning

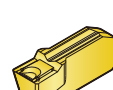
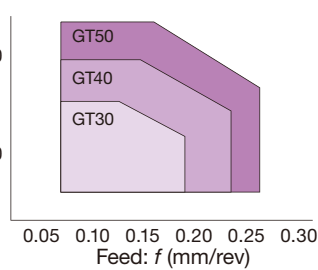
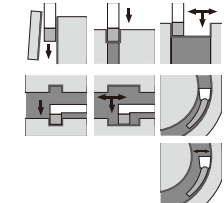
<p>GT</p>  <p>F260</p>	<p>1st choice for turning Low cutting force and good chip control for traversing CW = 3 - 5 mm</p>	 
---	--	--

Please see page F*** for the product details.

For aluminium and non-ferrous metal

GE-AL

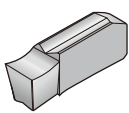

F261

Reduce cutting force and welding due to sharp chipbreaker

CW = 3 - 4 mm

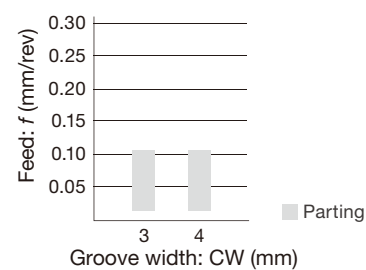

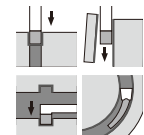

Please see page F*** for the product details.



INSERTS (1 corner)

GE-R/L

For parting off (handed inserts)

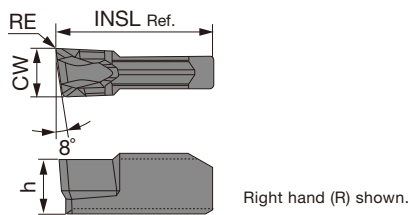

P Steel	★ ★									
M Stainless	★ ★									
K Cast iron	★ ☆									
N Non-ferrous										
S Superalloys	☆									
H Hard materials										

★ : First choice
☆ : Second choice

Designation	HAND	CW ^{+0.1} ₀	RE	Coated		INSL	h
				AH120	GH730		
GE30R	R	3	0.2	●	●	10	3.5
GE30L	L	3	0.2		●	10	3.5
GE40R	R	4	0.2	●	●	10	4
GE40L	L	4	0.2		●	10	4
GE50R	R	5	0.2		●	12	4.5
GE50L	L	5	0.2	●	●	12	4.5

●: Line up

Reference pages: Toolholders → **F256**, Standard cutting conditions → **F261**

GE

For external grooving and parting

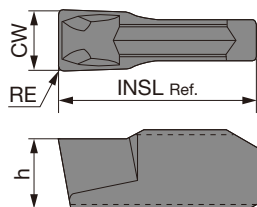

P	Steel	★	★	★				★				
M	Stainless		★	★								
K	Cast iron		★	☆				☆				
N	Non-ferrous											
S	Superalloys			☆								
H	Hard materials											

★ : First choice
☆ : Second choice

Designation	CW ^{+0.1} ₀	RE	Coated			Cermet			INSL	h
			T9225	AH120	GH730	NS9530				
GE30	3	0.2	●	●	●			●	10	3.5
GE40	4	0.2	●	●	●			●	10	4
GE50	5	0.2	●	●	●			●	12	4.5

● : Line up

GF

For face grooving

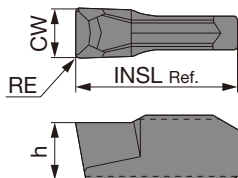

P	Steel	★			★							
M	Stainless	★										
K	Cast iron	☆			☆							
N	Non-ferrous											
S	Superalloys											
H	Hard materials											

★ : First choice
☆ : Second choice

Designation	CW ^{+0.1} ₀	RE	Coated	Cermet				INSL	h
			GH730	NS9530					
GF30	3	0.2	●	●				10	3.5
GF40	4	0.2	●	●				10	4
GF50	5	0.2	●	●				12	4.5

● : Line up



GN

For internal grooving

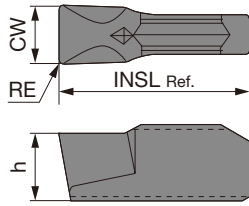

P	Steel	★											
M	Stainless	★											
K	Cast iron	☆											
N	Non-ferrous												
S	Superalloys												
H	Hard materials												

★ : First choice
☆ : Second choice

Designation	CW ^{+0.1} ₀	RE	Coated										INSL	h	
			GH730												
GN30	3	0.2	●											10	3.5
GN40	4	0.2	●											10	4
GN50	5	0.2	●											12	4.5

● : Line up

GT

For external grooving and turning

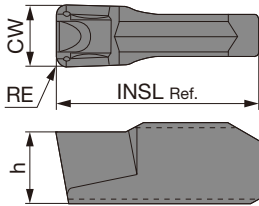

P	Steel	★	★	★					★						
M	Stainless		★	★											
K	Cast iron		★	☆				☆							
N	Non-ferrous														
S	Superalloys			☆											
H	Hard materials														

★ : First choice
☆ : Second choice

Designation	CW ^{+0.1} ₀	RE	Coated			Cermet			INSL	h
			T9225	AH120	GH730	NS9530				
GT30	3	0.4	●	●	●	●			10	3.5
GT40	4	0.4	●	●	●	●			10	4
GT50	5	0.4	●	●	●	●			12	4.5

● : Line up

Reference pages: Toolholders → **F256**

GE-AL

For aluminium and non-ferrous metal

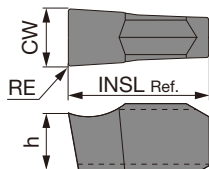

P	Steel									
M	Stainless									
K	Cast iron									
N	Non-ferrous	★								
S	Superalloys									
H	Hard materials									

★ : First choice
☆ : Second choice

Designation	CW ^{+0.1}	RE	Uncoated							INSL	h
			KS05F								
GE30-AL	3	0.2	●							10	3.5
GE40-AL	4	0.2	●							10	4

●: Line up

STANDARD CUTTING CONDITIONS (for 1 corner inserts)

ISO	Workpiece material	Grade	Cutting speed Vc (m/min)
P	Low carbon steel, Alloy steel (~ HB150)	T9225	80 - 300
		NS9530	100 - 200
		GH730, AH120	50 - 180
	Medium carbon steel, Alloy steel (HB150 ~ 250)	T9225	80 - 220
		NS9530	80 - 180
		GH730, AH120	50 - 150
High carbon steel, Alloy steel (HB250 ~)	T9225	80 - 220	
	NS9530	80 - 150	
	GH730, AH120	50 - 120	
M	Stainless steel	GH730, AH120	50 - 120
K	Grey iron, Ductile cast iron	GH730, AH120	50 - 180
N	Aluminium alloy, Non-ferrous metal	KS05F	200 - 300

For Parting

Operation	Feed: f (mm/rev)		
	Groove width: CW (mm)		
	3	4	5
Grooving (GE**)	0.06 - 0.25	0.07 - 0.27	0.07 - 0.3
Parting-off (GE**R/L)	0.04 - 0.14	0.04 - 0.14	0.04 - 0.14
Traversing (GT**)	ap = 0.5 - 1.5 f = 0.06 - 0.2	ap = 0.5 - 2 f = 0.06 - 0.25	ap = 0.5 - 2.5 f = 0.06 - 0.27
Parting-off for Aluminium alloys (GE**-AL)	0.03 - 0.1	0.03 - 0.1	-

Reference pages: Toolholders → **F256**

Grade
Insert
Ext. Toolholder
Int. Toolholder
Threading
Grooving
Miniature tool
Milling cutter
Endmill
Drilling tool
Tooling System
User's Guide
Index



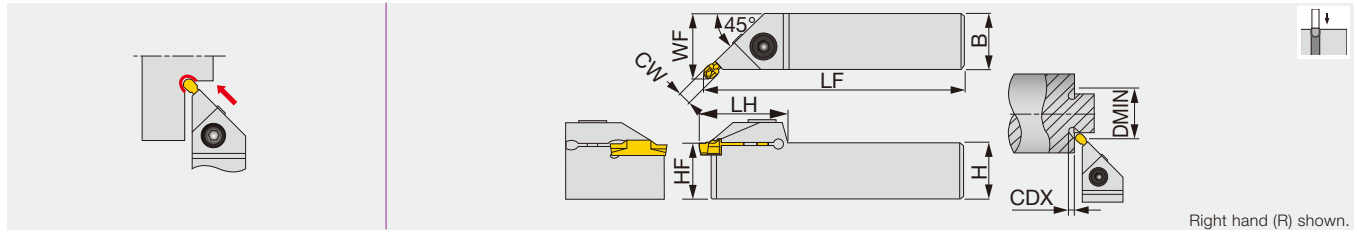

Designation	CW	DMIN	Seat size	CDX	H	B	LF	LH	HF	WF ⁽¹⁾	Insert	Torque*
CGEUR/L1616-3T02	3	32	3	2.8	16	16	110	30	16	19.3	DTIU...	5
CGEUR/L2020-3T02	3	32	3	2.8	20	20	125	30	20	23.3	DTIU...	5
CGEUR/L2525-3T02	3	32	3	2.8	25	25	150	30	25	28.3	DTIU...	5
CGEUR/L1616-4T02	4	32	4	2.8	16	16	110	31	16	19.5	DTIU...	8.5
CGEUR/L2020-4T02	4	32	4	2.8	20	20	125	31	20	23.5	DTIU...	8.5
CGEUR/L2525-4T02	4	32	4	2.8	25	25	150	31	25	28.5	DTIU...	8.5
CGEUR/L2525-6T03	6	34	5, 6	3.4	25	25	150	35	25	28.9	DTIU...	8.5

(1) "WF" value is calculated with groove width "CW" shown in the table.
Torque*: Recommended clamping torque (N·m)

CTER/L-15A

Square shank toolholder for profiling aluminium wheel

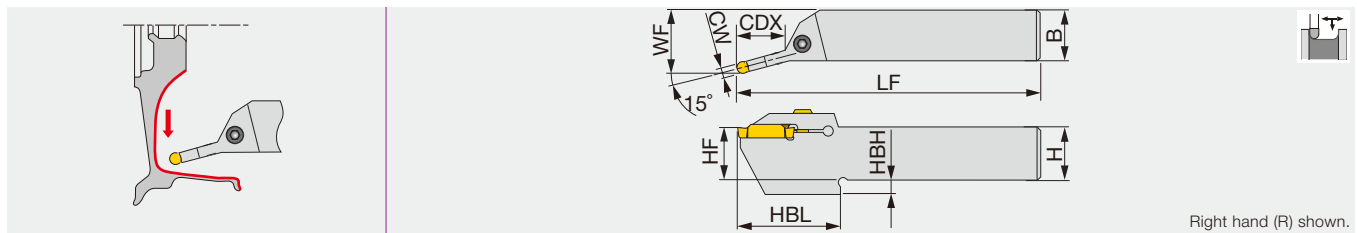

Designation	CW	Seat size	CDX	H	B	LF	HF	WF	HBH	HBL	Insert	Torque*
CTER/L2525-6T25-15A	6	6	25	25	25	150	25	32.2	7	50.5	DTA...	5
CTER/L2525-8T30-15A	8	8	30	25	25	150	25	32.9	7	55	DTA...	5

Torque*: Recommended clamping torque (N·m)

SPARE PARTS

Designation	Clamping screw	Wrench
CGEUR/L****-3T02	CM5X0.8X16-A	P-4
CGEUR/L1616-4T02	CM6X1X16-A	P-5
CGEUR/L2020-4T02	CM6X1X20-A	P-5
C**R/L2525-...	CM6X1X25-A	P-5

CGIUR/L

Internal 45° undercutting toolholder

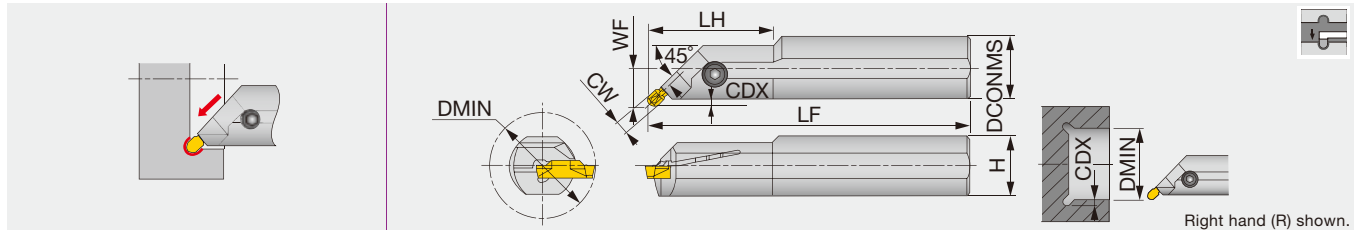

Designation	CW	DMIN	Seat size	CDX	DCONMS	H	LF	LH	WF ⁽¹⁾	Insert	Torque*
CGIUR/L20-3T02-D380	3	38	3	2.8	20	19	160	-	12.8	DTIU...	5
CGIUR/L25-3T02-D380	3	38	3	2.8	25	23	200	40	14.8	DTIU...	5
CGIUR/L20-4T02-D380	4	38	4	2.8	20	19	160	-	12.9	DTIU...	5
CGIUR/L25-4T02-D460	4	46	4	2.8	25	23	200	40	14.9	DTIU...	5
CGIUR/L25-6T02-D460	6	46	5, 6	2.8	25	23	200	-	15.2	DTIU...	8.5

(1) WF is calculated with the groove width CW in the above table.
Torque*: Recommended clamping torque (N·m)

SPARE PARTS

Designation	Clamping screw	Wrench
CGIUR/L20-3T02-D380	CM5X0.8X12-A	P-4
CGIUR/L25-3T02-D380	CM5X0.8X16-A	P-4
CGIUR/L*-4T02-D...	CM5X0.8X16-A	P-4
CGIUR/L25-6T02-D460	CM6X1X25-A	P-5

CGIUR/L-15A

Round-shank toolholder for profiling aluminium wheel

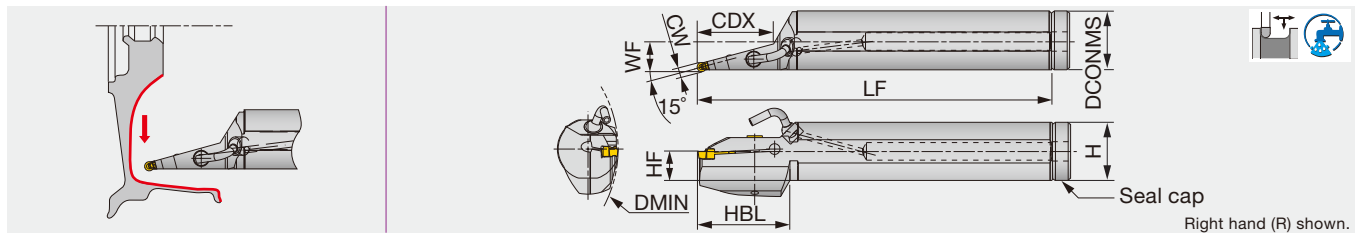

Designation	CW	DMIN	Seat size	CDX	DCONMS	H	WF	LF	HF	HBL	Insert	Seal cap	Torque*
CGIUR/L40-6T50-D160-15A	6	160	6	50	40	38.5	19.7	320	19	60	DTA...	CA-40	5
CGIUR/L40-8T83-D160-15A	8	160	8	83	40	38.5	20.5	320	19	85	DTA...	CA-40	5
CGIUR/L50-6T85-D200-15A	6	200	6	85	50	48.5	25.2	350	23.5	85	DTA...	-	5
CGIUR/L50-8T85-D200-15A	8	200	8	85	50	48.5	25.9	350	23.5	85	DTA...	-	5

Torque*: Recommended clamping torque (N·m)

SPARE PARTS

Designation	Clamping screw	Wrench	Seal cap
CGIUR/L*-15A	CM6X1X25-A	P-5	CA-40

NOZZLE

Coolant pipe	Coolant nozzle
PNZ5	CNZ125

Reference pages: Inserts → **F264, F265**, Standard cutting conditions → **F265**

CHIPBREAKER GUIDE

Profiling and undercutting

**DTIU type
(2 corners)**

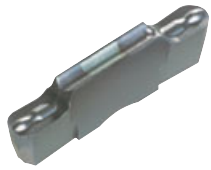

Full radius type

Excellent chip control for undercutting
CW = 3 - 6 mm

■ Standard feed and DoC

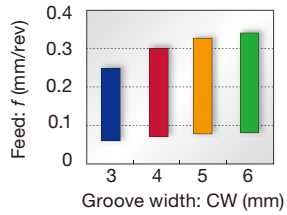

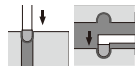

Aluminium wheel machining

**DTA type
(2 corners)**



Full radius type

Excellent chip control
For aluminium wheel profiling
Ground insert
CW = 6 - 8 mm

■ Standard feed and DoC (for turning)

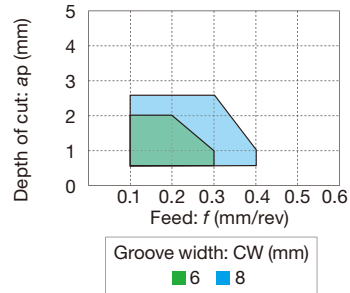



INSERTS

DTIU

Profiling and undercutting (for high precision)

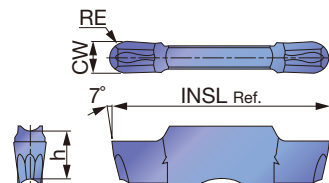

P	Steel	★	☆	☆																
M	Stainless	★	☆	★																
K	Cast iron	★		☆																
N	Non-ferrous																			
S	Superalloys	★	☆																	
H	Hard materials																			

★ : First choice
☆ : Second choice

Designation	Seat size	CW±0.02	RE	Coated										INSL	h			
				AH7025	AH725	GH130												
DTIU300-150	3	3	1.5	●	●	●											20	5
DTIU400-200	4	4	2	●	●	●											20	5
DTIU500-250	5	5	2.5	●	●	●											25	5.5
DTIU600-300	6	6	3	●	●	●											25	5.5

●: Line up

Reference pages: Toolholders → **F262, F263**

DTA

Aluminium wheel machining (for high precision)

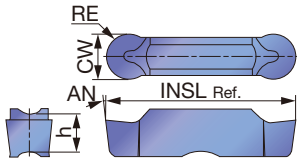

Designation	Seat size	CW±0.02	RE	Uncoated						INSL	h	AN
				TH10								
DTA600-300	6	6	3	●						25	5.5	7°
DTA800-400	8	8	4	●						30	6.7	10°

●: Line up

P Steel												
M Stainless												
K Cast iron												
N Non-ferrous				★								
S Superalloys												
H Hard materials												

★ : First choice
☆ : Second choice

STANDARD CUTTING CONDITIONS

ISO	Workpiece material	Hardness	Priority	Grade	Cutting speed Vc (m/min)
P	Steel S45C, SCM435, etc. C45, 34CrMo4, etc.	< 300 HB	First choice	AH7025, AH725	50 - 180
		< 300 HB	Impact resistance	GH130	50 - 120
M	Stainless steel SUS303, SUS304, etc. X10CrNiS18-9, X5CrNi18-9, etc.	< 200 HB	First choice	AH7025, AH725	50 - 120
		< 200 HB	Impact resistance	GH130	50 - 120
K	Grey cast iron FC250, etc. 250, etc.	-	First choice	AH7025	150 - 700
		-	Impact resistance	GH130	50 - 180
	Ductile cast iron FCD450, etc. 450-10S, etc.	-	First choice	AH7025	150 - 300
		-	Impact resistance	GH130	50 - 120
N	Aluminium alloys Si < 12%	-	First choice	TH10	100 - 500
S	Superalloys Inconel718, etc.	< HRC 40	First choice	AH7025, AH725	20 - 60
		< HRC 40	Impact resistance	GH130	20 - 40
	Titanium alloys Ti-6Al-4V, etc.	< HRC 40	Impact resistance	AH7025, AH725	20 - 80

Please see page **F264** for feed: f (mm/rev).

Reference pages: Toolholders → **F262, F263**



PARTS FOR COOLANT HOSE

Connecting hose

Fig.1

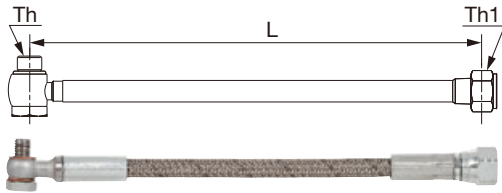
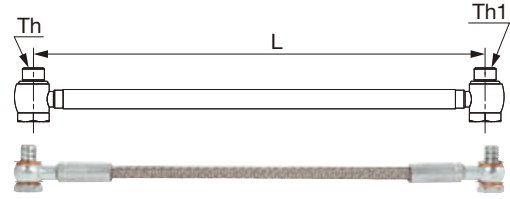
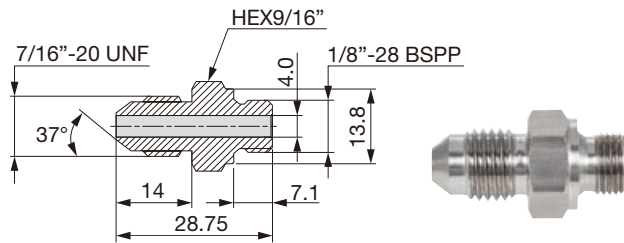

Fig.2



Designation	Length		Screw		Max. pressure (Mpa)	Fig.
	L	Th	Th1			
CHP-HOSE-G1/8-7/16-200BS	200	G1/8"-28 BSPP	7/16"-20 UNF	26	1	
CHP-HOSE-G1/8-7/16-250BS	250	G1/8"-28 BSPP	7/16"-20 UNF	26	1	
CHP-HOSE-5/16-7/16-200BS	200	5/16"-24UNF	7/16"-20 UNF	20	1	
CHP-HOSE-5/16-G1/8-200BS	200	5/16"-24UNF	G1/8"-28 BSPP	20	1	
CHP-HOSE-G1/8-G1/8-200BB	200	G1/8"-28 BSPP	G1/8"-28 BSPP	26	2	
CHP-HOSE-G1/8-G1/8-250BB	250	G1/8"-28 BSPP	G1/8"-28 BSPP	26	2	

Connector



Designation
CHP-NIPPLE-G1/8-7/16UNF

Seal washer



Designation	øD	ød	W
CHP-COPPER-SEAL1/8	15	10	1
CHP-COPPER-SEAL5/16	11.9	8.15	1.35
CHP-COPPER-SEAL5/16-2.5	9.4	8	2.5

Connector elbow

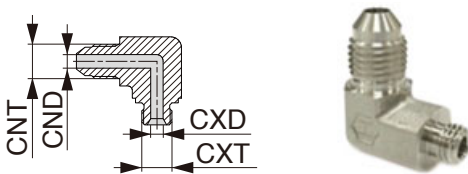

Designation	CNT	CND	CXT	CXD
CHP-ELBOW-90-G1/8-7/16UNF	7/16"-20 UNF	4.4	1/8"-28 BSPP	4
CHP-ELBOW-90-5/16-7/16UNF	7/16"-20 UNF	4.4	5/16"-24 UNF	4

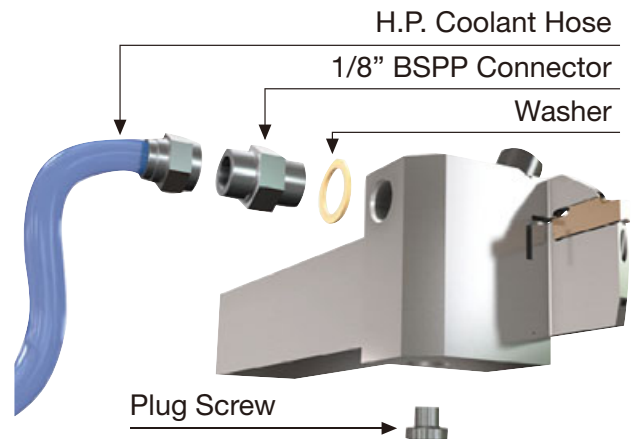

Miniature Machining



Miniature Machining - Content structure

- Products are listed by application.
- In the same application, products are listed by cutting edge shape.
- The same cutting edge shape are sorted by insert.
- Items are listed by product series.
- Toolholders in the catalog are our standard items.

How to use the page

- Method ①** Select the application and the cutting edge shape described at the left end of each page, jump to the page on the left index, and choose a designation you need (⑤) in the dimension table (④). Applicable inserts are shown in (⑦) and (⑨).
- Method ②** Select the cutting edge on **G003** and check the details on the product page.
- Method ③** Select the series name on **G003** and check the details on each page.
- Method ④** Select an item from Quick Guide on **G004 - G035**.

③ **MODUMTURN**
QC12-JSCL2CR-Y
Screw-on Y-axis turning modular head with 95° approach angle, for positive 80° rhombic inserts

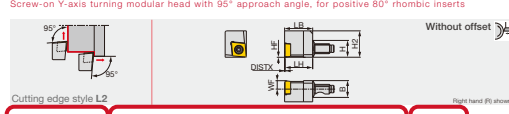

Cutting edge style L2

Designation	H	B	LH	HF	WF	LB	H2	DISTX	RE**	Insert	Torque*
QC12-JSCL2CR95-Y	12	12	19.5	0	6	19.8	18.6	0.3	0.2	CC*95T3...	1.2

Torque*: Recommended clamping torque (N·m)
RE**: Standard corner radius

① **⑤** **QC12-J2CR-Y-CHP**
Screw-on Y-axis turning modular head with 95° approach angle, for positive 80° rhombic inserts, with high pressure coolant capability

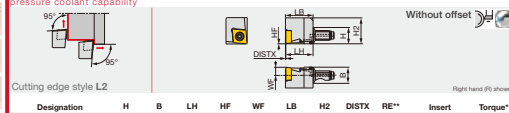

Cutting edge style L2

Designation	H	B	LH	HF	WF	LB	H2	DISTX	RE**	Insert	Torque*
QC12-JSCL2CR95-Y-CHP	12	12	19.5	0	6	19.8	18.6	0.3	0.2	CC*95T3...	1.2

Torque*: Recommended clamping torque (N·m)
RE**: Standard corner radius

② **④** **QC12-JSCL2CR**
Screw-on modular head with 95° approach angle, for positive 80° rhombic inserts

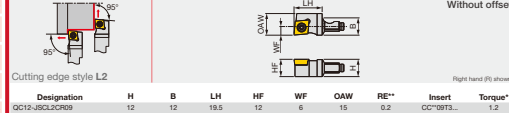

Cutting edge style L2

Designation	H	B	LH	HF	WF	OAW	RE**	Insert	Torque*
QC12-JSCL2CR95	12	12	19.5	12	6	15	0.2	CC*95T3...	1.2

Torque*: Recommended clamping torque (N·m)
RE**: Standard corner radius

⑦ **⑧** **SPARE PARTS**

Designation	Clamping screw	Wrench	O-ring
QC12-JSCL2CR95-Y	C8TB-4SD	T-8F	-
QC12-JSCL2CR95-Y-CHP	C8TB-4SD	T-8F	OR55-0454 SXL 0NB7R0

Reference pages - QC12-JSCL2CR-Y, QC12-JSCL2CR-Y-CHP, QC12-JSCL2CR:
Inserts → B112 -, CBN → B191, PCD → B213, Shank, Accessory → G095, G096

G040 tungaloy.com

⑥ **MODUMTURN**
QC12-JSCL2CR-CHP
Screw-on modular head with 95° approach angle, for positive 80° rhombic inserts, with high pressure

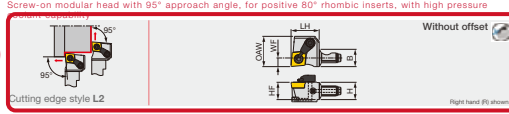

Cutting edge style L2

Designation	H	B	LH	HF	WF	OAW	RE**	Insert	Torque*
QC12-JSCL2CR95-CHP	12	12	19.5	12	6	21	0.2	CC*95T3...	1.2

Torque*: Recommended clamping torque (N·m)
RE**: Standard corner radius

⑧ **SPARE PARTS**

Designation	Clamping screw	Wrench	O-ring
QC12-JSCL2CR95-CHP	C8TB-4SD	T-8F	OR55-0454 SXL 0NB7R0

⑨ **INSERT SELECTION**

Application area	Precision finishing	Finish cutting	Medium to finish cutting	Application area	Precision finishing	Finish cutting	Medium to finish cutting	
Grade	SH725	JP	JS	SH725	JP	JS	SH725	
Breaker Shape	QD4	QD4	QD4	QD4	QD4	QD4	QD4	
Cutting conditions	QD4				QD4			
Grade	SH725	JP	JS	SH725	JP	JS	SH725	
Breaker Shape	QD4	QD4	QD4	QD4	QD4	QD4	QD4	
Cutting conditions	QD4				QD4			
Grade	SH725	JP	JS	SH725	JP	JS	SH725	
Breaker Shape	QD4	QD4	QD4	QD4	QD4	QD4	QD4	
Cutting conditions	QD4				QD4			
Grade	SH725	JP	JS	SH725	JP	JS	SH725	
Breaker Shape	QD4	QD4	QD4	QD4	QD4	QD4	QD4	
Cutting conditions	QD4				QD4			
Grade	SH725	JP	JS	SH725	JP	JS	SH725	
Breaker Shape	QD4	QD4	QD4	QD4	QD4	QD4	QD4	
Cutting conditions	QD4				QD4			
Grade	SH725	JP	JS	SH725	JP	JS	SH725	
Breaker Shape	QD4	QD4	QD4	QD4	QD4	QD4	QD4	
Cutting conditions	QD4				QD4			

Reference pages - QC12-JSCL2CR-CHP: Inserts → B112 -, CBN → B191, PCD → B213, Shank, Accessory → G095, G096

Tungaloy G041

- ①** : Application
- ②** : Cutting edge shape
- ③** : Tool series name
- ④** : Dimension table
- ⑤** : Toolholder designation
- e.g. right-hand, 25x25 square shank
- ⑥** : Dimension drawing (conforming to ISO13399)
- ⑦** : Applicable insert
- ⑧** : Spare parts
- ⑨** : Insert selection
- ⑩** : Reference page

→ **JSDJ2XR1212 X07-CHP**

When ordering

- Please specify the designation and quantity.
- e.g. **JSWL2XR1212X04-CHP** ... 1 (one toolholder per package)
- * Inserts are not included. Please order those separately.

Main products

L		G040
95°		
J		G052
93°		
N		G070
63°		
P		G073
62.5°		
A		G074
91°		
G		G078
91°		
D		G079
45°		
F		G080
91°		
Special		G081

	<h2>MODUM^{INI}TURN</h2> <p>Modular head turning toolholder system</p> 	G036
	<h2>MINI^{V LOCK}GROOVE</h2> <p>High precision grooving and threading tool series for CNC automatic lathes</p> 	G022, G030, G110 -, G150 -
	<h2>MINI^{FORCE}TURN</h2> <p>Economical double-sided inserts with excellent sharpness</p> 	G039
	<h2>J-SERIES</h2> <p>Toolholders for small-part machining</p> 	G004 -, G042 - G051, G054 -, G063 - G070 -, G073 -, G084 - G088 -, G133 -, G164 -
	<h2>TETRAM^{INI}CUT</h2> <p>Unique insert pocket geometry for grooving with high quality and precision</p>  <p>CW = 0.33 - 3.18 mm</p>	G022 - G026 -, G030 - G113 -, G147 -, G152 -
	<h2>TETRA^{FORCE}CUT</h2> <p>4-cornered insert with good clamping rigidity for highly precise grooving and parting</p>  <p>CW = 0.5 - 3.18 mm</p>	G022, G126 -
	<h2>DUO^{FORCE}CUT</h2> <p>New flexible turning tool series for CNC automatic lathes and cam-driven lathes</p> <p>CW = 0.5 - 1 mm</p>	G026, G086 -, G167 -
	<h2>DUO^{JUST}CUT</h2> <p>Innovative clamping system for high rigidity in parting</p>  <p>CW = 0.6 - 2 mm</p>	G026 -, G032 - G158 -, G169 -
	<h2>TUNG^{INI}CUT</h2> <p>Multi-functional tool series for various grooving operations</p>  <p>CW = 1.2 - 4 mm</p>	G028 -, G177 -
	<h2>TINY^{INI}M TURN</h2> <p>Solid boring bar for turning small diameters with high precision</p> 	G034 -, G097 -
	<h2>TUNG^{HEAVY}GROOVE</h2> <p>Highly rigid clamping for wide grooving and profiling in one pass</p> <p>CW = 10 - 25 mm</p>	G024, G138 -

Miniature External Turning - Quick Guide

CC** inserts

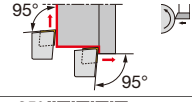
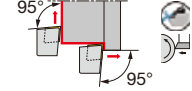
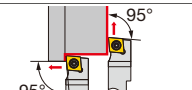
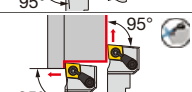
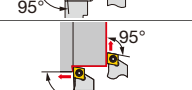
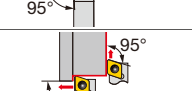
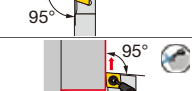
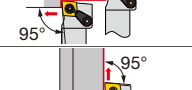
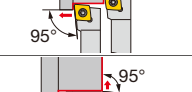
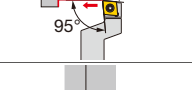
Cutting edge angle	Application	Designation	Insert	Square shank (height x width)						Holder			Clamping style		Offset	Page
				8 x 8	10 x 10	12 x 12	12 x 16	16 x 16	16 x 20	MODUM TM TURN (Modular head)	Y-axis feed	TUNGJET TM (Through-coolant)	Screw-on	Back-clamp		
95°		QC12-JSCL2CR-Y	CC**09			○	○			○	○		✓		without*	G040
		QC12-JSCL2CR-Y-CHP	CC**09			○	○			○	○	○	✓		without	G040
		QC12-JSCL2CR	CC**09			○	○			○			✓		without*	G040
		QC12-JSCL2CR-CHP	CC**09			○	○			○		○	✓		without*	G041
		JSCL2CR/L	CC**06/09		○	○		○					✓		without*	G042
		JTCL2CR/L	CC**06/09		○	○		○						✓	without	G042
		JSCL2CR/L-CHP	CC**09			○		○				○	✓		without*	G042
		JSCLCR/L	CC**06/09	○	○	○		○					✓		with	G043
		JSCLCR-F15	CC**09				○		○				✓		with	G043
91°		JSCGCR/L	CC**06/09			○		○					✓	with	G078	

* When using stepped-head shank, the "Offset" will be "with".

CN** inserts

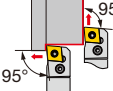
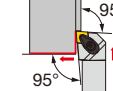
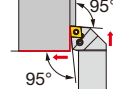
Cutting edge angle	Application	Designation	Insert	Square shank		Clamping style		Offset	Page
				16 x 16	20 x 20	Lever-lock	Double-clamp		
95°		PCL2NR	CN**1204		○	✓		without	G050
		ACLNR/L	CN**0904/ 1204		○		✓	with	C015
		PCLNR	CN**1204		○	✓		with	G050

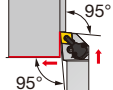
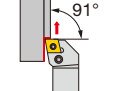

CN** inserts

Cutting edge angle	Application	Designation	Insert	Square shank		Holder TUNG T-BET (Through-coolant)	Clamping style		Offset	Page
				16 x 16	20 x 20		Lever-lock	Double-clamp		
95°		PCLNR/L-CHP	CN**0904/ 1204		○	○	✓		with	C019
91°		PCFNR/L	CN**1204		○		✓		with	C087

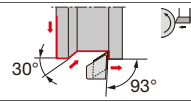
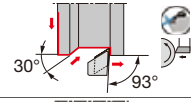
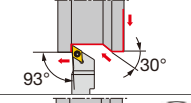
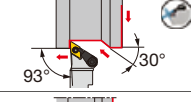
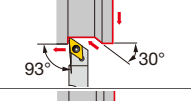
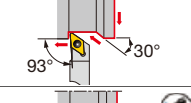
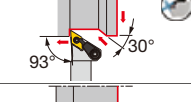
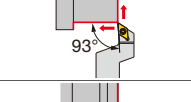
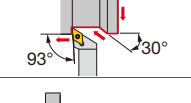
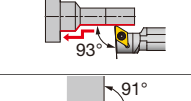
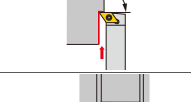
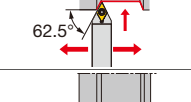
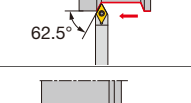
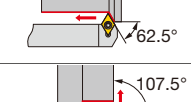

Miniature External Turning - Quick Guide

DC** inserts

Cutting edge angle	Application	Designation	Insert	Square shank (height x width)						Cylindrical shank (shank dia.)							
				8 x 8	10 x 10	10 x 12	10 x 16	12 x 12	12 x 16	16 x 16	16 x 20	20 x 20	ø19.05	ø20	ø22	ø25.4	
93°		QC12-JSDJ2CR-Y	DC**11					○	○								
		QC12-JSDJ2CR-Y-CHP	DC**11					○	○								
		QC12-JSDJ2CR	DC**07/11					○	○								
		QC12-JSDJ2CR-CHP	DC**07/11					○	○								
		JSDJ2CR/L	DC**07/11	○	○			○		○							
		JTDJ2CR/L	DC**07/11		○			○		○							
		JSDJ2CR/L-CHP	DC**07/11			○		○		○							
		JSDJCR-F15	DC**07/11				○		○		○						
		JSDJCR/L	DC**07/11	○	○			○		○							
		JS***-SDUCL	DC**07/11									○	○	○	○		
91°		JSDFCR/L	DC**07/11					○		○							
62.5°		JSDNCN	DC**07/11		○			○		○							
		SDNCN	DC**11							○							
		JSDN3CR	DC**07/11					○		○							
107.5°		SDQCR/L	DC**11								○						

* When using stepped-head shank, the "Offset" will be "with".

	Holder			Clamping style		Offset	Page
	MODUM ^{TURN} (Modular head)	Y-axis feed	TUNGALLOY (Through-coolant)	Screw-on	Back-clamp		
	○	○		✓		without*	G052
	○	○	○	✓		without	G052
	○			✓		without*	G053
	○		○	✓		without*	G053
				✓		without	G054
					✓	without	G054
			○	✓		without	G055 G056
				✓		with	G057
				✓		with	G056
				✓		-	G081
				✓		with	G080
				✓		with	G070
				✓		with	C073
				✓		with	G070
				✓		with	C096

Grade	A
Insert	B
Ext. Toolholder	C
Int. Toolholder	D
Threading	E
Grooving	F
Miniature tool	G
Milling cutter	H
Endmill	I
Drilling tool	J
Tooling System	K
User's Guide	L
Index	M

Miniature External Turning - Quick Guide

DX*U inserts

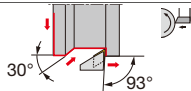
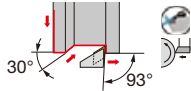
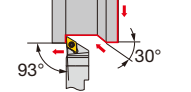
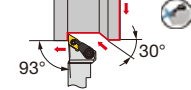
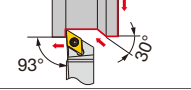
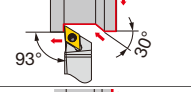
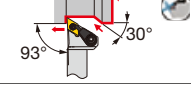
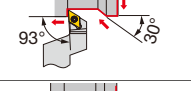
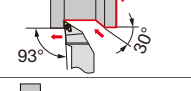
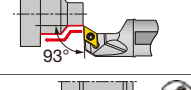
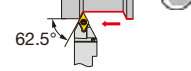
Cutting edge angle	Application	Designation	Insert	Square shank (height x width)								Cylindrical shank (shank dia.)						
				10 x 10	10 x 12	10 x 16	12 x 12	12 x 16	16 x 16	16 x 20	20 x 20	ø14	ø15.875	ø16	ø19.05	ø20		
93°		QC12-JSDJ2XR-Y	DX*U				○	○										
		QC12-JSDJ2XR-Y-CHP	DX*U				○	○										
		QC12-JSDJ2XR	DX*U				○	○										
		QC12-JSDJ2XR-CHP	DX*U				○	○										
		JSDJ2XR/L	DX*U	○			○		○			○						
		JPDJ2XR/L	DX*U	○			○		○									
		JSDJ2XR/L-CHP	DX*U		○		○		○									
		JSDJXR-F15	DX*U			○		○			○							
		JSDJXR/L	DX*U									○						
		JS***-SDUXL	DX*U										○	○	○	○	○	
62.5°		QC12-JSDNXR-CHP	DX*U				○	○										

* When using stepped-head shank, the "Offset" will be "with".

	ø22	ø25	ø25.4	Holder			Clamping style		Offset	Page
				MODUM TM TURN (Modular head)	Y-axis feed	TUNG TM JET (Through-coolant)	Screw-on	Back-clamp		
				○	○		✓		without*	G058
				○	○	○	✓		without*	G058
				○			✓		without*	G058
				○		○	✓		without*	G059
							✓		without	G059
								✓	without	G060
						○	✓		without	G060
							✓		with	G061
							✓		with	C045
	○	○	○				✓		-	G082
				○	○		✓		with	G072

Grade

A

Insert

B

Ext. Toolholder

C

Int. Toolholder

D

Threading

E

Grooving

F

Miniature tool

G

Milling cutter

H

Endmill

I

Drilling tool

J

Tooling System

K

User's Guide

L

Index

M

Miniature External Turning - Quick Guide

DN** inserts

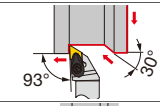
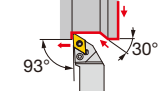
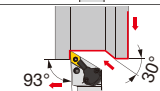
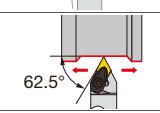
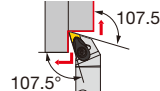
Cutting edge angle	Application	Designation	Insert	Square shank		Holder TUNGTJET (Through-coolant)	Clamping style		Offset	Page
				16 x 16	20 x 20		Lever-lock	Double-clamp		
93°		ADJNR/L	DN**1104/ 1504/1506		○			✓	with	C034
		PDJNR/L	DN**1104/ 1504/1506	○	○		✓		with	G068
		PDJNR/L-CHP	DN**1104/ 1504		○	○	✓		with	C037
62.5°		ADPNN	DN**1504		○			✓	with	C108
107.5°		ADQNR/L	DN**1104/ 1504/1506		○			✓	with	C092

SC/P** inserts

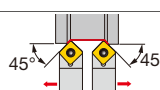
Cutting edge angle	Application	Designation	Insert	Square shank (height x width)			Clamping style		Offset	Page
				10 x 10	12 x 12	16 x 16	Screw-on	Back-clamp		
93°		SSDC/PN	SC**07/09 SP**04	○	○	○	✓		with	G079

TC** inserts

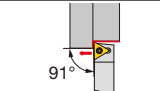
Cutting edge angle	Application	Designation	Insert	Square shank (height x width)				Clamping style		Offset	Page
				8 x 8	10 x 10	12 x 12	16 x 16	Screw-on	Back-clamp		
91°		JSTACR/L	TC**08/11	○	○	○	○	✓		without*	G074



TN** inserts

Cutting edge angle	Application	Designation	Insert	Square shank (height x width)			Holder TUNGTJET (Through-coolant)	Clamping style			Offset	Page	
				12 x 16	16 x 16	20 x 20		Lever-lock	Back-clamp	Double-clamp			
95°		PTL2NR/L	TN**1604			○		✓			without	G051	
		JTTLNR/L	TN**1604	○	○				✓		without	G051	
93°		ATJNR/L	TN**1604			○				✓	with	C032	
91°		JTTANR/L	TN**1604	○	○				✓		without	G077	
		ATGNR/L	TN**1604			○				✓	with	C057	
		PTGNR/L	TN**1104/ 1604		○	○		✓			with	C058	
		PTGNR/L -CHP	TN**1104/ 1604			○	○	✓			with	C059	
		ATFNR/L	TN**1604			○				✓	with	C088	
		PTFNR/L	TN**1104/ 1604		○	○		✓			with	C089	
	105°		ATQNR/L	TN**1604			○				✓	with	C091

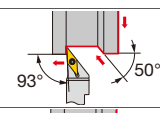
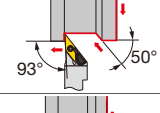
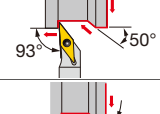
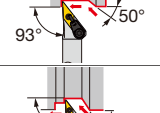
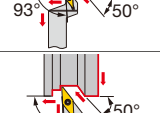
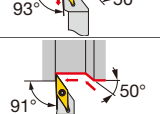
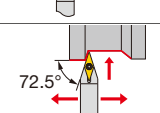
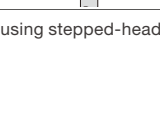

Miniature External Turning - Quick Guide

VB** inserts

Cutting edge angle	Application	Designation	Insert	Square shank (height x width)					Holder		Clamping style		Offset	Page		
				10 x 10	12 x 12	12 x 16	16 x 16	16 x 20	MODUMTURN (Modular head)	TUNGTJET (Through-coolant)	Screw-on	Back-clamp				
93°		QC12-JSVJ2BR	VB**11		○	○				○		✓		without*	G062	
		QC12-JSVJ2BR-CHP	VB**11		○	○			○	○	✓			without	G062	
		JSVJ2BR/L	VB**11	○	○			○				✓			without	G062
		JSVJ2BR/L-CHP	VB**11		○			○		○		✓			without	G063
		JSVJBR-F15	VB**11				○		○			✓			with	G064
		JSVJBR/L	VB**11	○	○			○				✓			with	G064
91°		JSVABR/L	VB**11	○	○						✓			without	G076	
72.5°		JSVNBN	VB**11	○	○			○			✓			with	G071	

* When using stepped-head shank, the "Offset" will be "with".

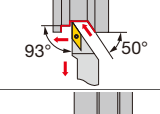
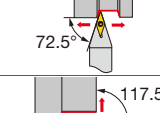
VC** inserts

Cutting edge angle	Application	Designation	Insert	Square shank		Clamping style		Offset	Page
				16 x 16	20 x 20	Screw-on	Back-clamp		
93°		SVJCR	VC**16	○	○	✓		with	C048
72.5°		SVVCN	VC**16		○	✓		with	C052
117.5°		SVQCR/L	VC**16		○	✓		with	C097

VP** inserts

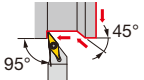
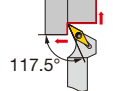
Cutting edge angle	Application	Designation	Insert	Square shank (height x width)			Clamping style		Offset	Page
				10 x 10	12 x 12	16 x 16	Screw-on	Back-clamp		
95°		JSVL2PR/L	VP**08/11	<input type="radio"/>	<input type="radio"/>	<input type="radio"/>	<input checked="" type="checkbox"/>		without	G044
117.5°		JSVP2PR/L	VP**08/11	<input type="radio"/>	<input type="radio"/>	<input type="radio"/>	<input checked="" type="checkbox"/>		without	G073

YWMT inserts

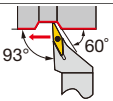
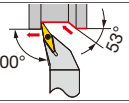
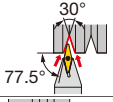
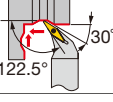
Cutting edge angle	Application	Designation	Insert	Square shank	Clamping style		Offset	Page
				20 x 20	Screw-on	Back-clamp		
93°		SYJBR/L	YWMT16	<input type="radio"/>	<input checked="" type="checkbox"/>		with	C049
100°		SYHBR/L	YWMT16	<input type="radio"/>	<input checked="" type="checkbox"/>		with	C099
77.5°		SYIBN	YWMT16	<input type="radio"/>	<input checked="" type="checkbox"/>		with	C053
122.5°		SYQBR/L	YWMT16	<input type="radio"/>	<input checked="" type="checkbox"/>		with	C098

Miniature External Turning - Quick Guide

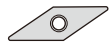

VXGU inserts

Cutting edge angle	Application	Designation	Insert	Square shank (height x width)								Cylindrical shank (shank dia.)					
				10 x 10	10 x 12	10 x 16	12 x 12	12 x 16	16 x 16	16 x 20	20 x 20	ø15.875	ø16	ø19.05	ø20	ø22	
93°		QC12-JSVJ2XR	VXGU				○	○									
		QC12-JSVJ2XR-CHP	VXGU				○	○									
		JSVJ2XR/L	VXGU	○			○		○			○					
		JPVJ2XR/L	VXGU	○			○		○								
		JSVJ2XR/L-CHP	VXGU		○		○		○								
		JSVJXR-F15	VXGU			○		○			○						
		JSVJXR/L	VXGU									○					
		JS***-SVUXL	VXGU										○	○	○	○	○
72.5°		QC12-JSVVXR-CHP	VXGU				○	○									



* When using stepped-head shank, the "Offset" will be "with".

	Holder		Clamping style		Offset	Page		
	ø25	ø25.4	MODUM ^{TURN} (Modular head)	TUNGJET ^{TURN} (Through-coolant)			Screw-on	Back-clamp
			○		✓	without*	G065	
			○	○	✓	without*	G066	
					✓	without	G065	
						✓	without	G066
					✓	without	G067	
					✓	with	G067	
			○		✓	with	C047	
	○	○			✓	-	C114	
			○	○	✓	with	G083	

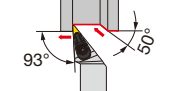
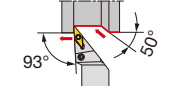
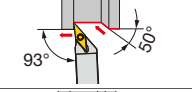
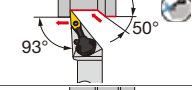
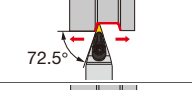
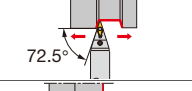
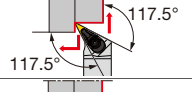
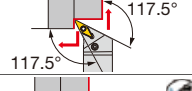

Miniature External Turning - Quick Guide

V/YN** inserts

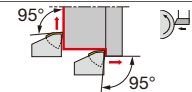
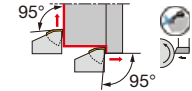
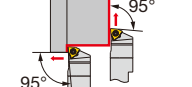

Cutting edge angle	Application	Designation	Insert	Square shank (height x width)			Holder TUNG TAPET (Through-coolant)	Clamping style			Offset	Page
				12 x 12	16 x 16	20 x 20		Lever-lock	Back-clamp	Double-clamp		
93°		AVJNR/L	VN**1204 V/YN**1604			○				✓	with	C041
		PVJNR/L	VN**1204		○	○		✓			with	C042
		JPVJ2NR/L	VN**1204	○	○				✓		without	G069
		PVJNR/L-CHP	VN**1204 V/YN**1604			○	○	✓			with	C043
72.5°		AVVNN	VN**1204 V/YN**1604			○				✓	with	C050
		PVVNN	VN**1204			○		✓			with	C050
117.5°		AVQNR/L	VN**1204 V/YN**1604			○				✓	with	C094
		PVQNR/L	VN**1204			○		✓			with	C094
		PVQNR/L-CHP	V/YN**1604			○	○	✓			with	C095

WXGU inserts

Cutting edge angle	Application	Designation	Insert	Square shank		Holder		Clamping style		Offset	Page	
				12 x 12	12 x 16	MODUMTURN (Modular head) Y-axis feed	TUNG TAPET (Through-coolant)	Screw-on	Back-clamp			
95°		QC12-JSWL2XR-Y	WXGU	○	○	○	○		✓		without*	G045
		QC12-JSWL2XR-Y-CHP	WXGU	○	○	○	○		✓		without	G045
		QC12-JSWL2XR	WXGU	○	○	○			✓		without*	G046

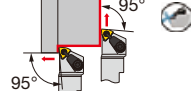
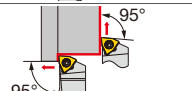
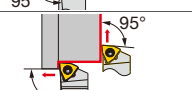
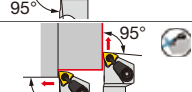
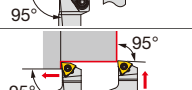

* When using stepped-head shank, the "Offset" will be "with".

WXGU inserts

Cutting edge angle	Application	Designation	Insert	Square shank (height x width)						Holder		Clamping style		Offset	Page	
				10 x 10	10 x 16	12 x 12	12 x 16	16 x 16	16 x 20	20 x 20	 (Modular head)	 (Through-coolant)	Screw-on			Back-clamp
95°		QC12-JSWL2XR-CHP	WXGU			○	○				○	○	✓		without*	G046
		JSWL2XR/L	WXGU	○		○		○					✓		without	G046
		JPWL2XR/L	WXGU	○		○		○						✓	without	G047
		JSWL2XR/L-CHP	WXGU			○		○				○	✓		without	G048
		JSWLXR-F15	WXGU		○		○		○					✓	with	G049

* When using stepped-head shank, the "Offset" will be "with".

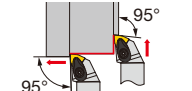
WN** inserts

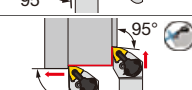
Cutting edge angle	Application	Designation	Insert	Square shank	Holder	Clamping style		Offset	Page
				20 x 20	 (Through-coolant)	Lever-lock	Double-clamp		
95°		AWLNR/L	WN**0604/ 0804	○			✓	with	C024
		PWLNR/L	WN**0604	○		✓		with	C026
		PWLNR/L-CHP	WN**0604/ 0804	○	○	✓		with	C026

Miniature External Turning - Quick Guide



JV*N inserts

Cutting edge angle	Application	Designation	Insert	Square shank (height x width)				Clamping style		Offset	Page
				6 x 6	7 x 7	8 x 8	10 x 10	Screw-on	Back-clamp		
Front turning		JSXXR/L*05	JVFN45R/L	<input type="radio"/>	<input type="radio"/>	<input type="radio"/>	<input type="radio"/>	<input checked="" type="checkbox"/>	<input type="checkbox"/>	without	G086



JXF inserts

Cutting edge angle	Application	Designation	Insert	Square shank (height x width)				Clamping style		Offset	Page
				10 x 10	12 x 12	16 x 16	20 x 20	Screw-on	Back-clamp		
Front turning, Reverse turning		JSXGR/L	JXFR/L8 JXRR/L8	<input type="radio"/>	<input type="radio"/>	<input type="radio"/>	<input type="radio"/>	<input checked="" type="checkbox"/>	<input type="checkbox"/>	without	G088



JXB inserts

Cutting edge angle	Application	Designation	Insert	Square shank (height x width)				Clamping style		Offset	Page
				10 x 10	12 x 12	16 x 16	20 x 20	Screw-on	Back-clamp		
Front turning		JSXBR/L	JXBR/L	<input type="radio"/>	<input type="radio"/>	<input type="radio"/>	<input type="radio"/>	<input checked="" type="checkbox"/>	<input type="checkbox"/>	without	G092



J10E inserts

Cutting edge angle	Application	Designation	Insert	Square shank (height x width)				Holder	Clamping style		Offset	Page
				10 x 10	12 x 12	12 x 16	16 x 16		Screw-on	Back-clamp		
Back turning		QC12-JSEGR	J10ER	<input type="radio"/>	<input type="radio"/>	<input type="radio"/>	<input type="radio"/>	MODUMTMTURN (Modular head) TUNGJET (Through-coolant)	<input checked="" type="checkbox"/>	<input type="checkbox"/>	without	G089
		QC12-JSEGR-CHP	J10ER	<input type="radio"/>	<input type="radio"/>	<input type="radio"/>	<input type="radio"/>	MODUMTMTURN (Modular head) TUNGJET (Through-coolant)	<input type="checkbox"/>	<input checked="" type="checkbox"/>	without	G089
		JSEGR/L	J10ER/L	<input type="radio"/>	<input type="radio"/>	<input type="radio"/>	<input type="radio"/>	MODUMTMTURN (Modular head) TUNGJET (Through-coolant)	<input type="checkbox"/>	<input checked="" type="checkbox"/>	without	G089

* When using stepped-head shank, the "Offset" will be "with".

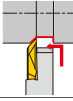
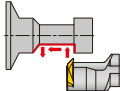

JTB inserts

Cutting edge angle	Application	Designation	Insert	Square shank (height x width)			Cylindrical shank (shank dia.)				Clamping style		Offset	Page
				10 x 10	12 x 12	16 x 16	ø19.05	ø20	ø22	ø25.4	Screw-on	Back-clamp		
Back turning		JSTBR/L3	JTBR/L3	○	○	○					✓		without	G083
		JS-TBL3	JTBR3				○	○	○	○	✓		-	G084

Grade

Insert

Ext. Toolholder

Int. Toolholder

Threading

Grooving

Miniature tool

Milling cutter

Endmill

Drilling tool

Tooling System

User's Guide

Index





Miniature Internal Turning - Quick Guide

Positive type

StreamJet-Bar

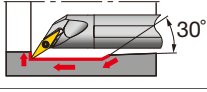
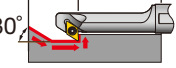
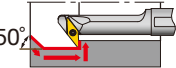
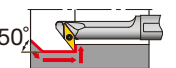
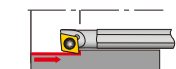

Appli- cation	Style	Designation	Insert	Material	Through coolant	ISO Insert	Min. bore diameter DMIN (mm)						Page
							0	10	20	30	40	50	
Boring & Internal facing		SEXPR/L	EP...	Steel Carbide	○	✓	0.5 - 7	0.5 - 7					D034 D035
		SCLCR/L	CC...	Steel Carbide	○	✓	5 - 27	5 - 27					D014 D016
		SCLPR/L	CP...	Steel Carbide	○	✓	10 - 27	10 - 20					D018 D019
Boring & internal profiling		SDUCR/L	DC...	Steel Carbide	○	✓	13 - 32	13 - 27					D056
		SDUPR/L	DPMT...	Steel Carbide	○	✓	15 - 22	15 - 22					D058
		SVUCR/L	VC...	Steel Carbide	○	✓	16 - 32	18 - 32					D061 D062
		SVUBR/L	VB...	Steel Carbide	○	✓	20 - 32	24.5 - 34					D059 D060
		SDQCR/L	DC...	Steel Carbide	○	✓	13 - 30	13 - 25					D076 D077
		SDQPR/L	DPMT...	Steel Carbide	○	✓	15 - 22	15 - 22					D078
		SVQCR/L	VC...	Steel Carbide	○	✓	13.5 - 21.5	13.5 - 21.5					D081 D082
		SVQBR/L	VB...	Steel Carbide	○	✓	17 - 30.5	17 - 30.5					D079 D080
		SYUBR/L	YW...	Steel Carbide	○	✓	20 - 24.5						D064
	Boring		SWUBR/L	WB...	Steel Carbide	○	✓	6 - 8	6 - 8				
		STUPR/L	TP...	Steel Carbide	○	✓	8 - 34	8 - 27					D053 D055
Blind hole boring		STFPR/L	TP...	Steel Carbide	○	✓	10 - 27	10 - 22					D046
		STFCR/L	TC...	Steel Carbide	○	✓	12 - 18	12 - 18					D045

StreamJet-Bar

Application	Style	Designation	Insert	Material	Through coolant	ISO Insert	Y-PRO	Min. bore diameter DMIN (mm)						Page
								0	10	20	30	40	50	
Internal undercut & profiling		SYQBR/L	YW...	Steel Carbide	○	✓		ø17	ø21.5					D083
								ø17	ø21.5					
Back boring		SDZCR/L	DC...	Steel Carbide	○	✓		ø14	ø25					D085
								ø18	ø22					
		SVZCR/L	VC...	Steel	○	✓			ø16					D088
		SVZBR/L	VB...	Steel	○	✓		ø20	ø40					D087
		SEZPR/L	EP...	Steel Carbide	○	✓		ø5.5	ø6.5					D084
Internal sphere cutting		SVJCR/L	VC...	Steel	○	✓		ø16	ø20					D039
		SVJBR/L	VB...	Steel	○	✓		ø25	ø30					D038

Double-sided insert with positive cutting edges

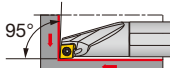
MiniForce-Turn

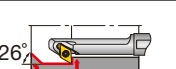
Application	Style	Designation	Insert	Material	Through coolant	MINIFURN	Min. bore diameter DMIN (mm)						Page	
							0	10	20	30	40	50		
Boring & internal facing		SCLXR/L	CXMU...	Steel Carbide	○	✓		ø12	ø22					D021
								ø12	ø22					
Boring & internal profiling		SWLXR/L	WX*U...	Steel Carbide	○	✓		ø12	ø22					D023
								ø12	ø22					
Boring & internal profiling		SDXXR/L	DX*U...	Steel Carbide	○	✓		ø13	ø24					D036
								ø13	ø24					
Back boring		SDZXR/L	DX*U...	Steel Carbide	○	✓		ø14	ø20					D086
								ø18	ø22					

Miniature Grooving - Quick Guide

External Grooving



MiniVLockGroove

Application	Designation	Insert	Square shank (height x width)					Holder			Groove width (mm)			Max. groove depth (mm)	Page
			8 x 8	10 x 10	10 x 12	12 x 12	12 x 16	MODUMTURN (Modular head)	TUNGETJET (Through-coolant)	Direct connection	0	1	2		
											0	1	2		
	QC12-SVER/L-CHP Modular head	VGP...				○	○	○	○	○	0.33	1		2.5 - 4	G110
	SVER/L	VGP...	○	○	○						0.5	1		2 - 4	G110
	SVER/L-CHP	VGP...			○	○			○	○	0.5	1		2.5 - 4	G110



TetraMini-Cut

Application	Designation	Insert	Square shank (height x width)						Cylindrical shank (shank dia.)								
			10 x 10	10 x 12	12 x 12	12 x 16	16 x 16	20 x 20	ø14	ø15.875	ø16	ø19.05	ø20	ø22	ø25	ø25.4	
	QC12-STCR/L-Y Modular head	TC*18R/L...			○	○											
	QC12-STCR/L-Y-CHP Modular head	TC*18R/L...			○	○											
	QC12-STCR/L Modular head	TC*18R/L...			○	○											
	QC12-STCR/L-CHP Modular head	TC*18R/L...			○	○											
	STCR/L-18	TC*18R/L...	○		○		○	○									
	STCR/L-18-CHP	TC*18R/L...		○	○		○	○									
	JS-STCL18	TC*18R...							○	○	○	○	○	○	○	○	○



TetraForce-Cut

Application	Designation	Insert	Square shank (height x width)				Holder		Groove width (mm)						Max. groove depth (mm)	Page
			10 x 10	12 x 12	16 x 16	20 x 20	TUNGETJET (Through-coolant)	Direct connection	0	1	2	3	4	5		
									0	1	2	3	4	5		
	STCR/L-27	TC*27...	○	○	○	○			0.5	3.18					1 - 6.4	G126
	STCR/L-27-CHP	TC*27...		○		○	○	○	0.5	3.18					1 - 6.4	G126
	STCR/L-38	TCL38...				○			0.5	4					9 - 10	G132

	Holder				Groove width (mm)						Max. groove depth (mm)	Page		
	MODUMTURN (Modular head)	Y-axis feed	TUNETILT (Through-coolant)	Direct connection	0	1	2	3	4	5				
	<input type="radio"/>	<input type="radio"/>			0.33							3.18	0.8 - 3.5	G113
	<input type="radio"/>	<input type="radio"/>	<input type="radio"/>	<input type="radio"/>	0.33							3.18	0.8 - 3.5	G113
	<input type="radio"/>				0.33							3.18	0.8 - 3.5	G114
	<input type="radio"/>		<input type="radio"/>	<input type="radio"/>	0.33							3.18	0.8 - 3.5	G114
					0.33							3.18	0.8 - 3.5	G115
			<input type="radio"/>	<input type="radio"/>	0.33							3.18	0.8 - 3.5	G115 G116
					0.33							3.18	0.8 - 3.5	G116

Grade	A
Insert	B
Ext. Toolholder	C
Int. Toolholder	D
Threading	E
Grooving	F
Miniature tool	G
Milling cutter	H
Endmill	I
Drilling tool	J
Tooling System	K
User's Guide	L
Index	M



Miniature Parting - Quick Guide

External Grooving

GTGN

Application	Designation	Insert	Square shank (height x width)			Groove width (mm)						Max. groove depth (mm)	Page	
			12 x 12	16 x 16	20 x 20	0	1	2	3	4	5			
	CER/L	GTGN-16E...	<input type="radio"/>	<input type="radio"/>	<input type="radio"/>	0	1	2.25					1 - 1.8	F093

TungHeavyGroove

Application	Designation	Insert	Square shank (height x width)			Groove width (mm)						Max. groove depth (mm)	Page	
			12 x 12	16 x 16	20 x 20	0	10	20	30	40	50			
	FPGN	PSGB...	<input type="radio"/>	<input type="radio"/>	<input type="radio"/>	0	10	25					-	G138
	SPGN	PSGB...	<input type="radio"/>	<input type="radio"/>	<input type="radio"/>	0	10	25					-	G139

Internal Grooving

AddInternalCut

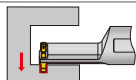
Application	Designation	Insert	Cylindrical shank		Groove width (mm)	Max. groove depth (mm)	Through coolant
			ø12	ø16			
	A/E-STCIR/L	TCIG10/12...	<input type="radio"/>	<input type="radio"/>	0.5 - 3	1 - 3	<input type="radio"/>

SNG

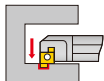
Application	Designation	Insert	Cylindrical shank (shank dia.)					Groove width (mm)	Max. groove depth (mm)	Through coolant
			ø8	ø10	ø12	ø16	ø20			
	A/E-SNGR	*GR/L... *GMR...	<input type="radio"/>	<input type="radio"/>	<input type="radio"/>	<input type="radio"/>	<input type="radio"/>	1 - 3.5	1.5 - 3	<input type="radio"/>

Grade	A
Insert	B
Ext. Toolholder	C
Int. Toolholder	D
Threading	E
Grooving	F
Miniature tool	G
Milling cutter	H
Endmill	I
Drilling tool	J
Tooling System	K
User's Guide	L
Index	M

Min. bore diameter DMIN (mm)

0 5 10 15 20 25 Page

ø10.5  ø20

G140

Min. bore diameter DMIN (mm)

0 5 10 15 20 25 Page

ø8  ø24

G142

Miniature Parting - Quick Guide

Internal Grooving



TetraMini-Cut

Application	Designation	Insert	Square shank (height x width)			Cylindrical shank (shank dia.)							
			10 x 10	12 x 12	16 x 16	ø14	ø15.875	ø16	ø19.05	ø20	ø22	ø25	ø25.4
	JS-STCFL18	TCF18L...				○	○	○	○	○	○	○	○
	STCFVR-18	TCF18L...	○	○	○								

Parting





DuoForceCut





Application	Designation	Insert	Square shank (height x width)				Groove width (mm)	Max. parting diameter (mm)					Page	
			6 x 6	7 x 7	8 x 8	10 x 10		0	10	20	30	40		50
	JSXXR/L*05	JVPN...	○	○	○	○	0.5 - 1	ø4	○	ø12				G167



DuoJustCut

Application	Designation	Insert	Square shank (height x width)					Groove width (mm)	Holder
			10 x 10	10 x 12	12 x 12	16 x 16	20 x 20		
	JSXXR/L*09	JXP...	○		○	○	○	0.6 - 2	
	JSXXR/L*09-CHP	JXP...		○	○	○		0.6 - 2	○
	JSXXR/L-S	JXP...			○	○		0.6 - 2	
	JSXXR/L*09-S-CHP	JXP...	○		○	○		0.6 - 2	○

	Groove width (mm)	Max. groove depth (mm)	Min. face groove outside diameter (mm)					Page
			0	5	10	15	20	
	0.5 - 2.5	1 - 3						G147
	0.5 - 2.5	1 - 3						G147

	Max. parting diameter (mm)						Page
	0	10	20	30	40	50	
							G169
							G170
							G169
							G170

Grade

Insert

Ext. Toolholder

Int. Toolholder

Threading

Grooving

Miniature tool

Milling cutter

Endmill

Drilling tool

Tooling System

User's Guide







Index







Miniature Parting - Quick Guide

Parting

 **TungCut**

Application	Designation	Insert	Square shank (height x width)						Groove width (mm)	Holder		
			10 x 10	12 x 12	12 x 16	16 x 16	20 x 12	20 x 20		MODUMTURN (Modular head)	TUNGJET (Through-coolant)	Direct connection
	QC12-JTTER/L-CHP Modular head	DG.../ SG...		○	○				1.2 - 2.39	○	○	○
	J*TER/L	DG.../ SG...	○	○		○	○	○	1.2 - 3.18			
	JCTER/L-CHP	DG.../ SG...		○		○		○	2 - 2.39		○	○
	CGER/L	DG.../ SG...		○		○		○	1.4 - 4			
	CHGP	DG.../ SG...						○	2 - 4			
	CGP	DG.../ SG...						○	1.4 - 8			

 **AddForceCut**

Application	Designation	Insert	Square shank 20 x 20	Groove width (mm)	Max. parting diameter (mm)						Page
					0	25	50	75	100	125	
	QSER/L	QG...	○	2 - 4			ø52	ø66			G191
	QSG	QG...	○	2 - 4			ø52		ø82		G192
	QSP	QG...	○	2 - 5			ø50			ø120	G191

Max. parting diameter (mm)						
10	25	50	75	100	125	Page
ø20						G178
ø12		ø42				G177 G178 G179
ø25		ø32				G180
ø29		ø55				G179
	ø52		ø82			G180
ø26				ø120		G181

Grade

A

Insert

B

Ext. Toolholder

C

Int. Toolholder

D

Threading

E

Grooving

F

Miniature tool

G

Milling cutter

H

Endmill

I

Drilling tool

J

Tooling System

K

User's Guide

L

Index

M

Miniature Threading - Quick Guide

External Threading









MiniVLockGroove

Application	Designation	Insert	Square shank (height x width)			Corner R (mm)	Holder			Pitch (mm)						Page	
			10 x 10	12 x 12	12 x 16		MODUM TM TURN (Modular head)	TUNGJET (Through-coolant)	Direct connection	0	1	2	3	4	5		
	QC12-SVER/L-CHP Modular head	VGT10F...		○	○	0.05 - 0.1	○	○	○	0.4			2				G150
	SVER/L	VGT10F...	○	○		0.05 - 0.1				0.4			2				G150
	SVER/L-CHP	VGT10F...		○		0.05 - 0.1		○	○	0.4			2				G150



TetraMini-Cut

Application	Designation	Insert	Square shank (height x width)					Cylindrical shank (shank dia.)									
			10 x 10	12 x 12	12 x 16	16 x 16	20 x 20	ø14	ø15.875	ø16	ø19.05	ø20	ø22	ø25	ø25.4		
	QC12-STCR/L-Y Modular head	TCT18R/L...		○	○												
	QC12-STCR/L-Y-CHP Modular head	TCT18R/L...		○	○												
	QC12-STCR/L Modular head	TCT18R/L...		○	○												
	QC12-STCR/L-CHP Modular head	TCT18R/L...		○	○												
	STCR/L-18	TCT18R/L...	○	○		○	○										
	STCR/L-18-CHP	TCT18R/L...	○	○		○	○										
	JS-STCL18	TCT18R...							○	○	○	○	○	○	○	○	





Corner R (mm)	Holder				Pitch (mm)						Page
	MODULURN (Modular head)	Y-axis feed	TUNGSTJET (Through-coolant)	Direct connection	0	1	2	3	4	5	
0.05 - 0.2	<input type="radio"/>	<input type="radio"/>				0.4				3	G152
0.05 - 0.2	<input type="radio"/>	<input type="radio"/>	<input type="radio"/>	<input type="radio"/>		0.4				3	G152
0.05 - 0.2	<input type="radio"/>					0.4				3	G153
0.05 - 0.2	<input type="radio"/>		<input type="radio"/>	<input type="radio"/>		0.4				3	G153
0.05 - 0.2						0.4				3	G154
0.05 - 0.2			<input type="radio"/>	<input type="radio"/>		0.4				3	G154 G155
0.05 - 0.2						0.4				3	G155

Grade	A
Insert	B
Ext. Toolholder	C
Int. Toolholder	D
Threading	E
Grooving	F
Miniature tool	G
Milling cutter	H
Endmill	I
Drilling tool	J
Tooling System	K
User's Guide	L
Index	M







Miniature Threading - Quick Guide

External Threading

 **DuoJust-Cut**



Application	Designation	Insert	Square shank (height x width)					Cylindrical shank (shank dia.)					Corner R (mm)	Holder	
			10 x 10	10 x 12	12 x 12	16 x 16	20 x 20	ø19.05	ø20	ø22	ø25	ø25.4		TUNGJET (Through-coolant)	Direct connection
	JSXXR/L*09	JXTG12...	○		○	○	○						0.05Max. - 0.1		
	JSXXR/L*09-CHP	JXTG12...		○	○	○							0.05Max. - 0.1	○	○
	JSXXR/L*09-S	JXTG12...	○		○	○							0.05Max. - 0.1		
	JSXXR/L*09-S-CHP	JXTG12...			○	○							0.05Max. - 0.1	○	○
	JS-SXXL09	JXTG12R...						○	○	○	○	○	0.05Max. - 0.1		

 **TungThread**

Application	Designation	Insert	Square shank (height x width)								Cylindrical shank (shank dia.)					
			8 x 8	10 x 10	12 x 12	16 x 16	20 x 10	20 x 20	24 x 12	24 x 16	32 x 16	ø16	ø19.05	ø20	ø25	ø25.4
	SER*11	11ER...	○	○												
	JSE2R16-CHP	16ER...			○	○										
	CER/L	16ER/L...			○	○		○								
	JS-SEL16	16ER...									○	○	○	○	○	
	B-S/CER/L	16ER/L...						○		○						
	BC-SER/L	16ER/L...													○	

Internal Threading

 **TungThread**

Application	Designation	Insert	Min. bore diameter DMIN (mm)	Corner R (mm)	Pitch (mm)						Page
					0	1	2	3	4	5	
	SIR	6/8IR...	ø6.4 - ø8	0.04 - 0.17	0.5		2				E054
	SNR	6IR...	ø8 - ø10	0.04 - 0.1	0.5		1.75				E054

	Pitch (mm)					Page
	0	1	2	3	4	
0.2	1.5					G158
0.2	1.5					G159
0.2	1.5					G158
0.2	1.5					G159
0.2	1.5					G160

Corner R (mm)	Holder			Pitch (mm)					Page	
	MODULUM TURN (Modular head)	TUNGJET (Through-coolant)	Direct connection	0	1	2	3	4		5
0.04 - 0.19				0.35	1.5					G164
0.05 - 0.22	○	○	○	0.5	3					G162
0.05 - 0.22				0.5	3					E036
0.05 - 0.22				0.5	3					G163
0.05 - 0.22				0.5	3					G163
0.05 - 0.22				0.5	3					G163

Grade	A
Insert	B
Ext. Toolholder	C
Int. Toolholder	D
Threading	E
Grooving	F
Miniature tool	G
Milling cutter	H
Endmill	I
Drilling tool	J
Tooling System	K
User's Guide	L
Index	M

Miniature Internal Turning - Quick Guide

TinyMini-Turn

Solid carbide tools for small diameters turning

	Application	Description	Material	Through coolant	Cylindrical shank		Groove width
					ø4	ø7	
Boring, profiling & chamfering		TBT	Carbide		○	○	-
		JBT	Carbide	○	○	○	
Internal, Face grooving		TBP	Carbide		○	○	-
		JBP	Carbide	○	○	○	
Back boring & chamfering		TBU	Carbide			○	-
		JBU	Carbide	○		○	
Boring & 45° chamfering		TBC	Carbide			○	-
		JBC	Carbide	○		○	
Back boring		TBB	Carbide		○	○	-
		JBB	Carbide	○	○	○	
Threading (Metric thread)		TBI	Carbide		○	○	-
		JBI	Carbide	○	○	○	
Internal Grooving		TBG	Carbide		○	○	0.5 - 2
		JBG	Carbide	○	○	○	
Face grooving		TBF	Carbide			○	1 - 3
		JBF	Carbide	○		○	
Face grooving (for shaft)		TBS	Carbide			○	2
		JBS	Carbide	○		○	
Boring & profiling (full radius type)		TBR	Carbide			○	1
		JBR	Carbide	○		○	

Indexable tools for small diameters turning

	Application	Description	Cylindrical shank	Through coolant	Min. bore diameter DMIN (mm)						Page	
			ø7		0	2	4	6	8	10		
Boring & internal facing		SEXPR	○	○				ø5	ø6			G106
Back boring		SEZPR	○	○				ø5.5				G106

Min. bore diameter DMIN (mm)		Page										
0	2	4	6	8	10	12	14	15	Page			
ø0.6								ø7	G097			
ø1								ø7	G098			
ø2.8						ø5			G099			
ø2.8						ø5			G099			
			ø5							G099		
			ø5							G100		
			ø5					ø6.8	G100			
			ø5					ø6.8	G100			
	ø3						ø7		G101			
	ø3					ø5			G101			
		ø4					ø7		G101			
		ø4				ø6			G102			
	ø2						ø6.8		G102			
	ø2						ø6.8		G103			
			ø6								ø15	G104
			ø6								ø15	G104
			ø6								G105	
			ø6								G105	
		ø5					ø6.8			G105		
		ø5					ø6.8			G105		

Grade	A
Insert	B
Ext. Toolholder	C
Int. Toolholder	D
Threading	E
Grooving	F
Miniature tool	G
Milling cutter	H
Endmill	I
Drilling tool	J
Tooling System	K
User's Guide	L
Index	M

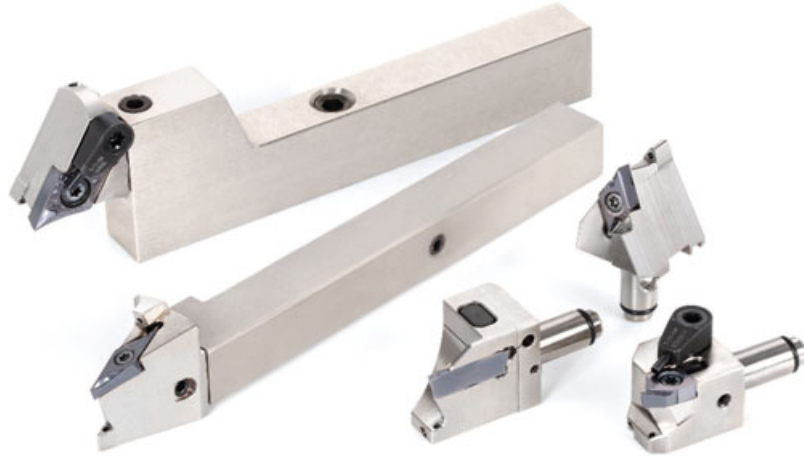

Modular style Swiss turning tool system facilitates tool changes with high repeatability

Unique coupling design

Simply loosen the clamping screw for easy tool exchanges. Unique coupling design allows extremely high repeatability.



Benefits of Y-axis feed

Designed with common functional lengths (LF), the cutting heads allow easy tool changes without removing the shank from the tool post.

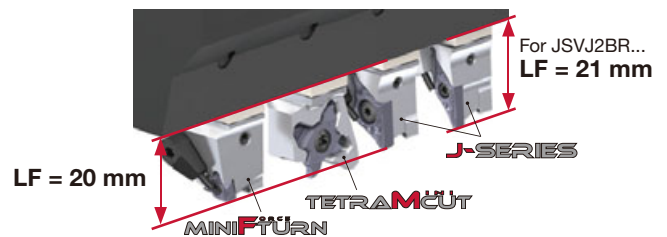

Benefits of Y-axis feed

No chip entanglements — Chips are directed downward and away from the cutting zone

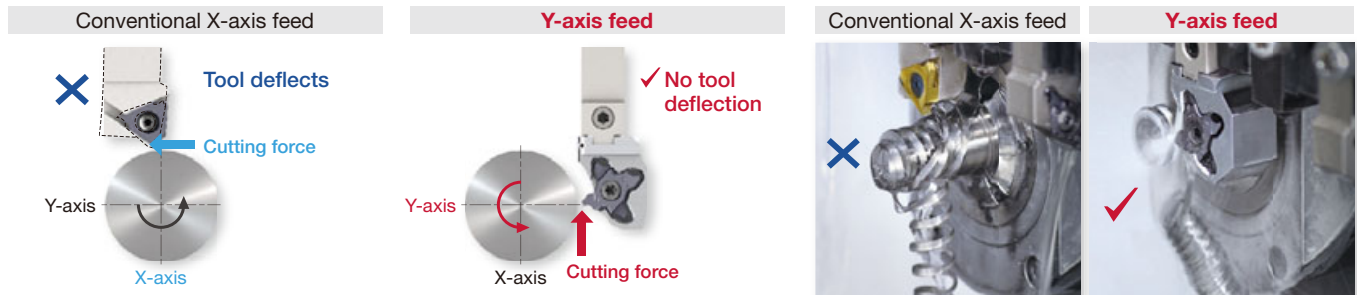

Reference pages : G040 -, G045 -, G052 -, G058 -, G062, G065, G072, G083, G089, G110, G113 -, G150, G152 -, G178
Shank, Accessory : G095, G096



Thru-coolant holder system

- High pressure coolant is supplied through the holder to facilitate smooth chip evacuation, improved chip breaking and reduced machine down-time

External coolant supply at normal pressure



High pressure coolant (7 MPa)

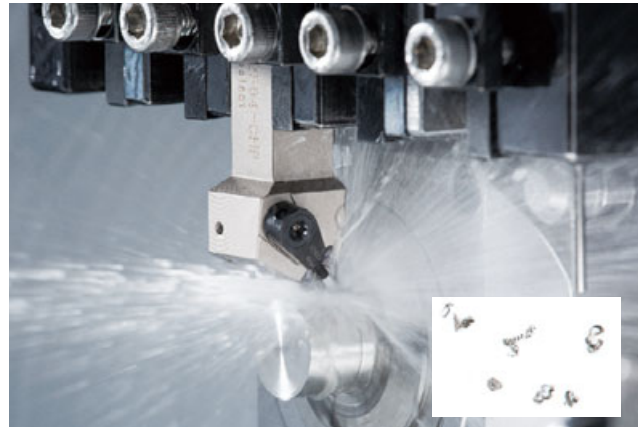

- Coolant jets from two outlets ensure high cutting efficiency and extended tool life

Directly to the cutting edge

- Reliable chip control
- Reduces crater and notch wears

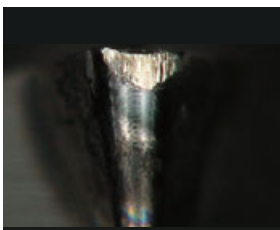

Excessive wear with external coolant supply (at normal pressure)

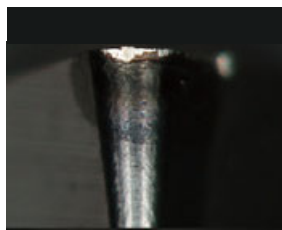

High pressure coolant (7 MPa)

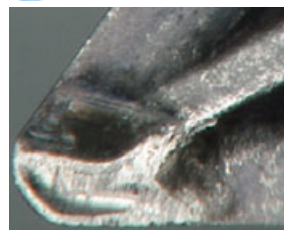

Excessive crater wear with external coolant supply (at normal pressure)

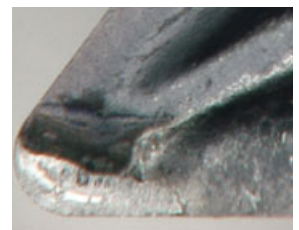

High pressure coolant (7 MPa)

Tube-free design streamlines tool setup.
Through-coolant supply enables high productivity

Conventional

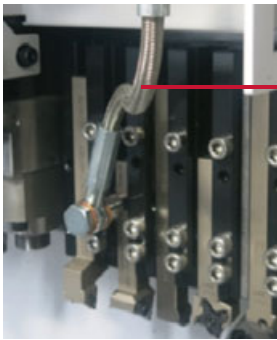

Hose



DirectTung-Jet system



No need for coolant tube setup.
Eliminates chip entanglement on tubes and streamlines tool replacement.

Coolant is supplied from the tool post directly to the tools.

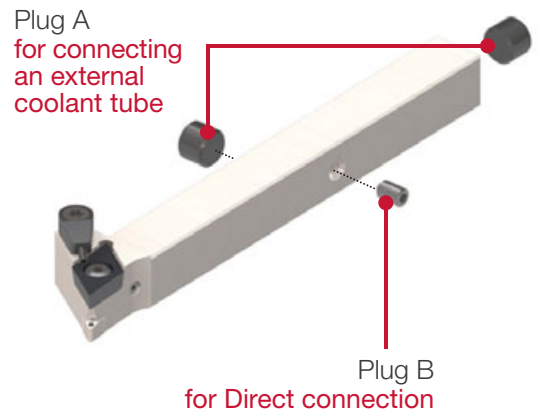
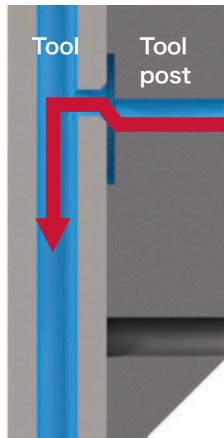
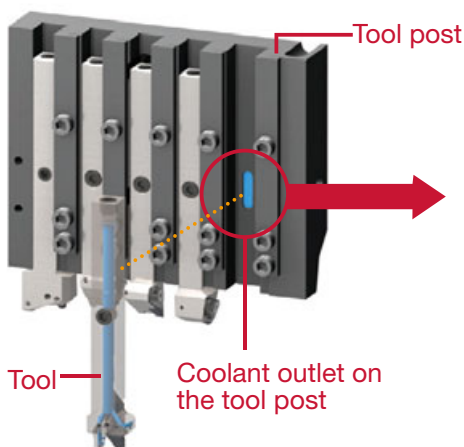

Use a non-coolant-through tool when a coolant supply is not needed through the tool.



Nozzle tube delivers coolant directly to the cutting edge

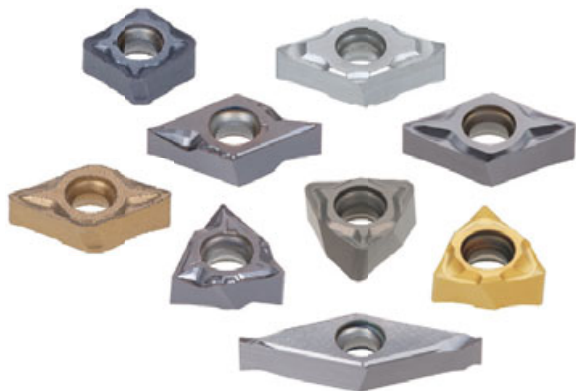

Economical double-sided positive insert

Innovative geometry and seat interface ensures stability and high performance.

Insert

CXMU0603... 4 edges, rhombic 80°

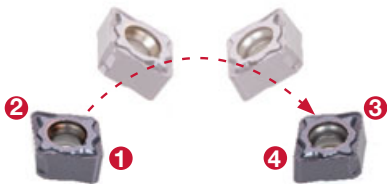

DXM/GU0703... 4 edges, rhombic 55°

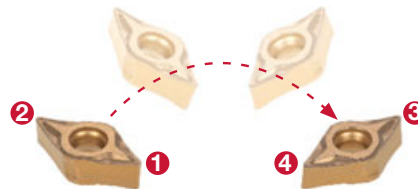

WXGU0403... 6 positive cutting edges

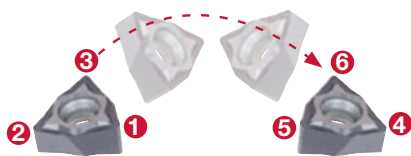

VXGU09T2... 4 positive cutting edges

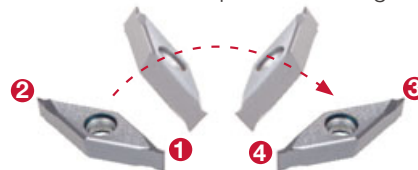

High rake angle

WXGU0403...

External turning



External turning



DXGU0703...

Internal turning

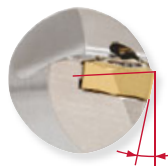

Internal turning

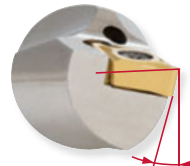

MODUM^{INI}TURN

QC12-JSCL2CR-Y

Screw-on Y-axis turning modular head with 95° approach angle, for positive 80° rhombic inserts

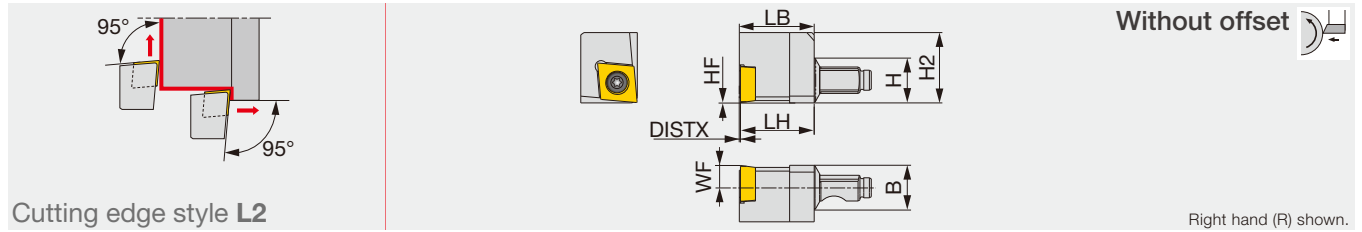

Designation	H	B	LH	HF	WF	LB	H2	DISTX	RE**	Insert	Torque*
QC12-JSCL2CR09-Y	12	12	19.5	0	6	19.8	18.6	0.3	0.2	CC**09T3...	1.2

Torque*: Recommended clamping torque (N-m)
RE**: Standard corner radius

QC12-JSCL2CR-Y-CHP

Screw-on Y-axis turning modular head with 95° approach angle, for positive 80° rhombic inserts, with high pressure coolant capability

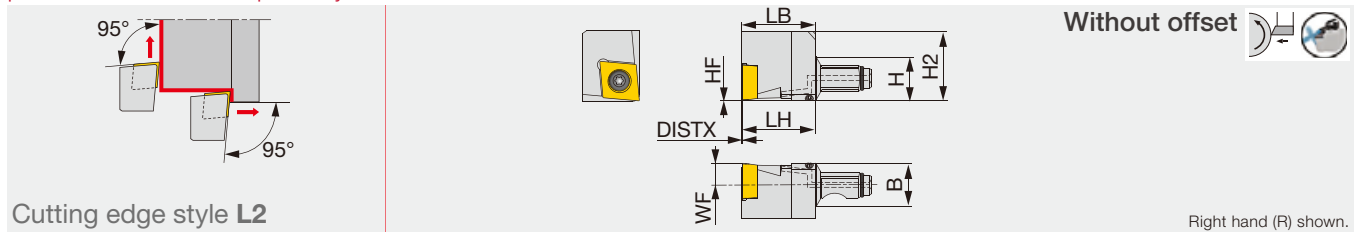

Designation	H	B	LH	HF	WF	LB	H2	DISTX	RE**	Insert	Torque*
QC12-JSCL2CR09-Y-CHP	12	12	19.5	0	6	19.8	18.6	0.3	0.2	CC**09T3...	1.2

Torque*: Recommended clamping torque (N-m)
RE**: Standard corner radius

QC12-JSCL2CR

Screw-on modular head with 95° approach angle, for positive 80° rhombic inserts

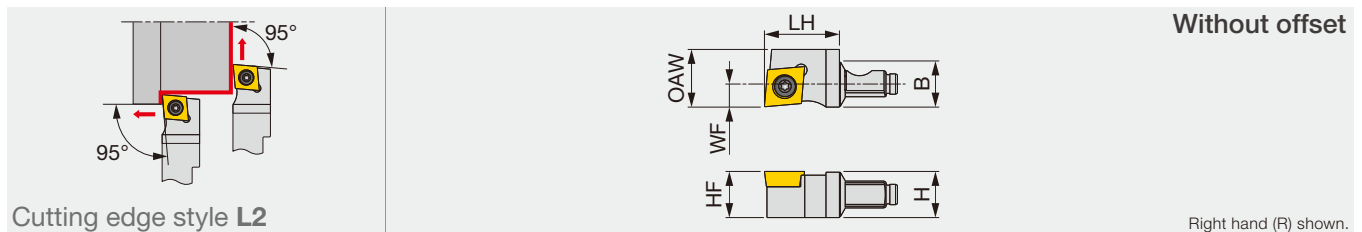

Designation	H	B	LH	HF	WF	OAW	RE**	Insert	Torque*
QC12-JSCL2CR09	12	12	19.5	12	6	15	0.2	CC**09T3...	1.2

Torque*: Recommended clamping torque (N-m)
RE**: Standard corner radius

SPARE PARTS

Designation	Clamping screw	Wrench	O-ring
QC12-JSCL2CR09-Y, QC12-JSCL2CR09	CSTB-4SD	T-8F	-
QC12-JSCL2CR09-Y-CHP	CSTB-4SD	T-8F	ORSS-0454.5X1.0NBR70

Reference pages : QC12-JSCL2CR-Y, QC12-JSCL2CR-Y-CHP, QC12-JSCL2CR:

Inserts → **B112 -**, CBN → **B191**, PCD → **B213**, Shank, Accessory → **G095**, **G096**

QC12-JSCL2CR-CHP

Screw-on modular head with 95° approach angle, for positive 80° rhombic inserts, with high pressure coolant capability

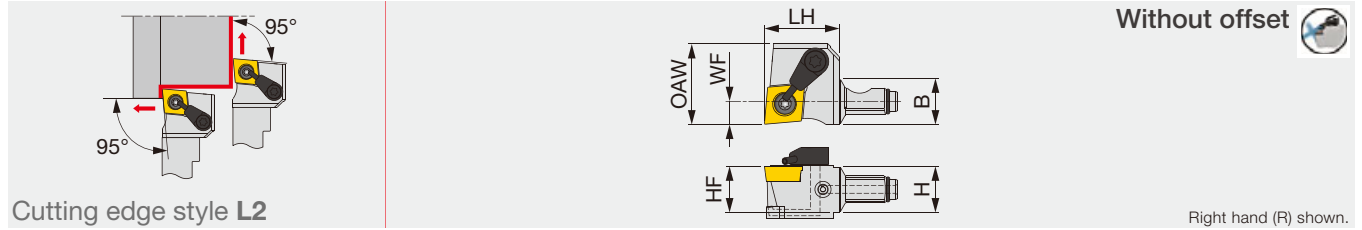

Designation	H	B	LH	HF	WF	OAW	RE**	Insert	Torque*
QC12-JSCL2CR09-CHP	12	12	19.5	12	6	21	0.2	CC**09T3...	1.2

Torque*: Recommended clamping torque (N-m)
RE**: Standard corner radius

SPARE PARTS

Designation	Clamping screw	Coolant unit	Wrench	O-ring
QC12-JSCL2CR09-CHP	CSTB-4SD	S-CU-CHP	T-8F	ORSS-0454.5X1.0NBR70

INSERT SELECTION

P	Application areas	Precision finishing	Finish cutting	Medium to finish cutting	M	Application areas	Precision finishing	Finish cutting	Medium to finish cutting	
	Grade	SH725	SH725	SH725		SH725	SH725	SH725	SH725	SH725
	Breaker Shape	01	JP	JS	JS	01	JP	JS	JS	
	Cutting conditions	G094					G094			
P	Application areas	Medium to finish cutting	M	Application areas	Medium to finish cutting					
	Grade	SH725		SH725						
	Breaker Shape	J10	J10							
	Cutting conditions	G094	G094							
K	Application areas	medium to finish cutting	N	Application areas	Precision finishing	Finish cutting	Medium cutting			
	Grade	T515		DX110	TH10	KS05F				
	Breaker Shape	CM	NS	W20	AL					
	Cutting conditions	B020	B022							
S	Application areas	Finish cutting	Medium to finish cutting	H	Application areas	Precision finishing	Finish cutting			
	Grade	SH725	SH725		Grade	BXA10	BXA20			
	Breaker Shape	JS	JS	Breaker Shape	CBN	CBN				
	Cutting conditions	G094		Cutting conditions	B026					

Reference pages : QC12-JSCL2CR-CHP: Inserts → **B112 -**, CBN → **B191**, PCD → **B213**, Shank, Accessory → **G095**, **G096**

Screw-on toolholder with 95° approach angle, for positive 80° rhombic inserts

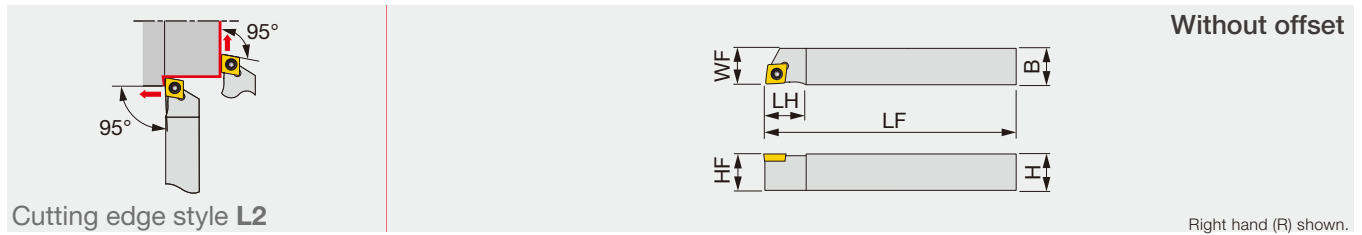

Cutting edge style L2

Without offset

Right hand (R) shown.

Designation	H	B	LF	LH	HF	WF	RE**	Insert	Torque*
JSCL2CR/L1010X06	10	10	120	12	10	10	0.2	CC**0602...	1.2
JSCL2CR/L1212F06	12	12	85	12	12	12	0.2	CC**0602...	1.2
JSCL2CR/L1212X06	12	12	120	12	12	12	0.2	CC**0602...	1.2
JSCL2CR/L1212F09	12	12	85	16	12	12	0.2	CC**09T3...	1.2
JSCL2CR/L1212X09	12	12	120	16	12	12	0.2	CC**09T3...	1.2
JSCL2CR/L1616X09	16	16	120	16	16	16	0.2	CC**09T3...	1.2

Torque*: Recommended clamping torque (N-m)
RE**: Standard corner radius

JTCL2CR/L

Back-clamp toolholder with 95° approach angle, for positive 80° rhombic inserts

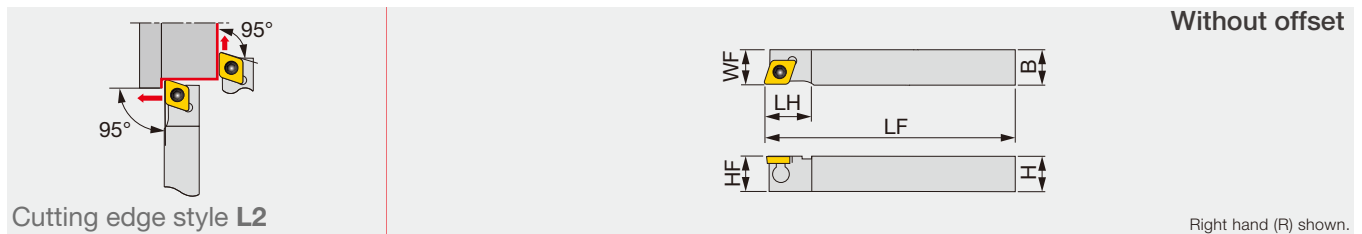

Cutting edge style L2

Without offset

Right hand (R) shown.

Designation	H	B	LF	LH	HF	WF	RE**	Insert	Torque*
JTCL2CR/L1010X06	10	10	120	12	10	10	0.2	CC**0602...	0.9
JTCL2CR/L1212F09	12	12	85	16	12	12	0.2	CC**09T3...	1.2
JTCL2CR/L1212X09	12	12	120	16	12	12	0.2	CC**09T3...	1.2
JTCL2CR/L1616X09	16	16	120	16	16	16	0.2	CC**09T3...	1.2

Torque*: Recommended clamping torque (N-m)
RE**: Standard corner radius

JSCL2CR-CHP

Direct connection

Screw-on toolholder without offset, 95° approach angle for positive 80° rhombic inserts, high pressure coolant compatible

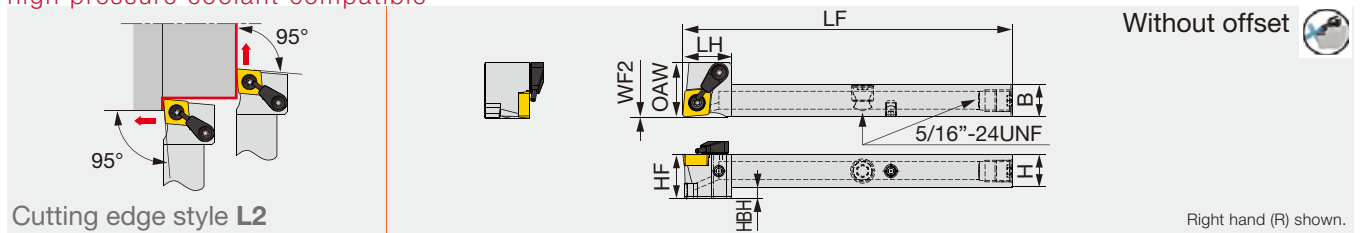

Cutting edge style L2

Without offset

Right hand (R) shown.

Designation	H	B	LF	LH	HF	HBH	WF2	OAW	RE	Insert	Torque*
JSCL2CR1212X09B-CHP	12	12	120	18	12	1.5	0	20	0.2	CC**09T3	1.2
JSCL2CR1616X09-CHP	16	16	120	18	16	0	0	20	0.2	CC**09T3	1.2

Torque*: Recommended clamping torque (N-m) RE**: Standard corner radius

SPARE PARTS

Designation	Clamping screw	Clamp	Clamping screw	Wrench	Wrench 1	Wrench 2 (Optional)
JTCL2CR/L**06	-	JCP-2	JDS-3525	P-2F	-	-
JTCL2CR/L**09	-	JCP-3	JDS-5040	P-2.5F	-	-
JSCL2CR/L**06	CSTB-2.5	-	-	-	T-8F	(T-8L)
JSCL2CR/L**09	CSTB-4SD	-	-	-	T-8F	(T-8L)

SPARE PARTS

Designation	Clamping screw	Coolant unit	Wrench	Coolant plug	Wrench 1	DirectJet plug	Wrench 2	Wrench 3 (Optional)
JSCL2CR**-CHP	CSTB-4SD	S-CU-CHP	T-8F	SR5/16UNFTL360	P-4	SSH4-6-TB	P-2	-

Reference pages : JSCL2CR/L, JTCL2CR/L, JSCL2CR-CHP: Inserts → B112 -, CBN → B191, PCD → B213

JSCLCR/L

Screw-on toolholder with 95° approach angle, for positive 80° rhombic inserts

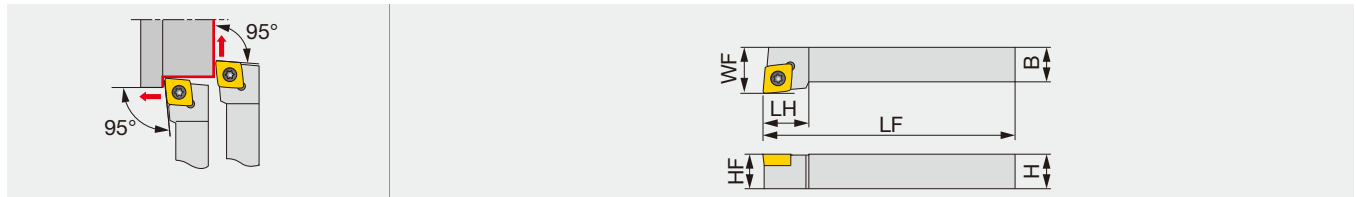

Cutting edge style L

Right hand (R) shown.

Designation	H	B	LF	LH	HF	WF	RE**	Insert	Torque*
JSCLCR/L0808H06	8	8	100	12	8	10	0.4	CC**0602...	1.2
JSCLCR/L1010H06	10	10	100	12	10	12	0.4	CC**0602...	1.2
JSCLCR/L1212H09	12	12	100	16	12	16	0.8	CC**09T3...	1.2
JSCLCR/L1616H09	16	16	100	16	16	20	0.8	CC**09T3...	1.2

Torque*: Recommended clamping torque (N-m)
 RE**: Standard corner radius

JSCLCR-F

Screw-on stepped-head toolholder with 95° approach angle, for positive 80° rhombic inserts

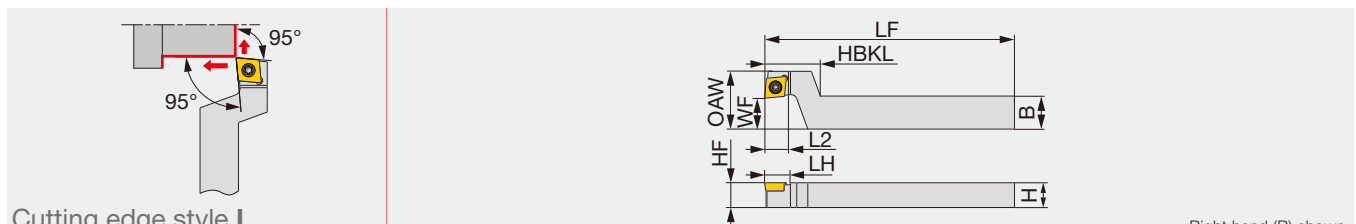

Cutting edge style L

Right hand (R) shown.

Designation	H	B	LF	L2	HBKL	LH	HF	WF	OAW	RE**	Insert	Torque*
JSCLCR/L1216F09-F15	12	16	85	12	27	12.5	12	15	28	0.2	CC**09T3...	1.2
JSCLCR/L1216X09-F15	12	16	120	12	27	12.5	12	15	28	0.2	CC**09T3...	1.2
JSCLCR/L1620X09-F15	16	20	120	12	27	12.5	16	15	28	0.2	CC**09T3...	1.2

Torque*: Recommended clamping torque (N-m)
 RE**: Standard corner radius

SPARE PARTS

Designation	Clamping screw	Wrench 1	Wrench 2 (Optional)
JSCLCR/L**H06	CSTB-2.5	T-8F	-
JSCLCR/L**H09	CSTB-4SD	T-8F	-
JSCLCR**F15	CSTB-4SD	T-8F	(T-8L)

INSERT SELECTION

P	Application areas	Precision finishing	Finish cutting	Medium to finish cutting	M	Application areas	Precision finishing	Finish cutting	Medium to finish cutting
	Grade	SH725	SH725	SH725		SH725	SH725	SH725	SH725
Breaker Shape					Breaker Shape				
Cutting conditions	G094				Cutting conditions	G094			
P	Application areas	Medium to finish cutting			M	Application areas	Medium to finish cutting		
	Grade	SH725				Grade	SH725		
Breaker Shape					Breaker Shape				
Cutting conditions	G094				Cutting conditions	G094			
K	Application areas	medium to finish cutting			N	Application areas	Precision finishing	Finish cutting	Medium cutting
	Grade	T515				Grade	DX110	TH10	KS05F
Breaker Shape					Breaker Shape				
Cutting conditions	B020				Cutting conditions	B022			
S	Application areas	Finish cutting	Medium to finish cutting			H	Application areas	Precision finishing	Finish cutting
	Grade	SH725	SH725				Grade	BXA10	BXA20
Breaker Shape					Breaker Shape				
Cutting conditions	G094				Cutting conditions	B026			

Reference pages : JSCLCR/L, JSCLCR-F: Inserts → B112 -, CBN → B191, PCD → B213

Screw-on toolholder with 95° approach angle, for positive 35° rhombic inserts

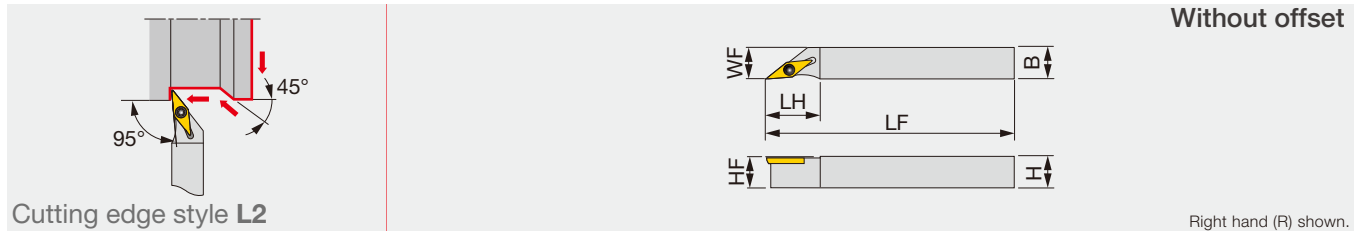

Designation	H	B	LF	LH	HF	WF	RE**	Insert	Torque*
JSVL2PR/L1010X08	10	10	120	16	10	10	0.2	VP**0802...	0.6
JSVL2PR/L1010K08	10	10	125	16	10	10	0.2	VP**0802...	0.6
JSVL2PR/L1212F08	12	12	85	16	12	12	0.2	VP**0802...	0.6
JSVL2PR/L1212F11	12	12	85	21	12	12	0.2	VP**1103...	1.2
JSVL2PR/L1212X08	12	12	120	16	12	12	0.2	VP**0802...	0.6
JSVL2PR/L1212X11	12	12	120	21	12	12	0.2	VP**1103...	1.2
JSVL2PR/L1212K08	12	12	125	16	12	12	0.2	VP**0802...	0.6
JSVL2PR/L1616X08	16	16	120	16	16	16	0.2	VP**0802...	0.6
JSVL2PL1616K08	16	16	125	16	16	16	0.2	VP**0802...	0.6
JSVL2PR/L1616X11	16	16	120	21	16	16	0.2	VP**1103...	1.2

Torque*: Recommended clamping torque (N-m)
RE**: Standard corner radius

SPARE PARTS

Designation	Clamping screw	Wrench 1	Wrench 2 (Optional)
JSVL2PR/L**08	CSTB-2L	T-6F	(T-6L)
JSVL2PR/L**11	CSTB-2.5	T-8F	(T-8L)

INSERT SELECTION

P	Application areas	Finish cutting	Finish cutting
	Grade	SH725	SH725
	Breaker Shape	JRP	JSP
Cutting conditions		G094	

M	Application areas	Finish cutting	Finish cutting
	Grade	SH725	SH725
	Breaker Shape	JRP	JSP
Cutting conditions		G094	

S	Application areas	Finish cutting	Finish cutting
	Grade	SH725	SH725
	Breaker Shape	JRP	JSP
Cutting conditions		G094	

Reference pages : JSVL2PR/L: Inserts → **B154** -

Screw-on Y-axis turning modular head with 95° approach angle, for WXGU inserts

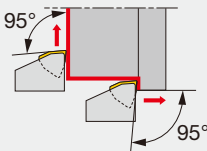

Cutting edge style L2

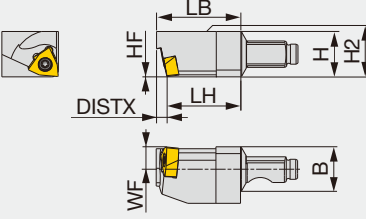

Without offset

Right hand (R) shown.

Designation	H	B	LH	HF	WF	LB	H2	DISTX	RE**	Insert	Torque*
QC12-JSWL2XR04-Y	12	12	19.5	0	6	22.3	12	2.8	0.2	WXGU0403**L...	0.9

Torque*: Recommended clamping torque (N-m)
 RE**: Standard corner radius
 Use right-hand toolholders (R) with left-hand inserts (L).

QC12-JSWL2XR-Y-CHP

Screw-on Y-axis turning modular head with 95° approach angle, for WXGU inserts, with high pressure coolant capability

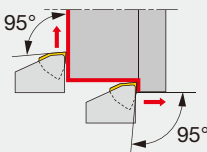

Cutting edge style L2

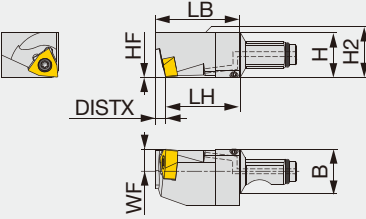

Without offset

Right hand (R) shown.

Designation	H	B	LH	HF	WF	LB	H2	DISTX	RE**	Insert	Torque*
QC12-JSWL2XR04-Y-CHP	12	12	19.5	0	6	22.3	12	2.8	0.2	WXGU0403**L...	0.9

Torque*: Recommended clamping torque (N-m)
 RE**: Standard corner radius
 Use right-hand toolholders (R) with left-hand inserts (L).

SPARE PARTS			
Designation	Clamping screw	Wrench	O-ring
QC12-JSWL2XR04-Y	SR34-514	T-7F	-
QC12-JSWL2XR04-Y-CHP	SR34-514	T-7F	ORSS-0454.5X1.0NBR70

INSERT SELECTION

For Swiss lathes

P	Application areas	Finish cutting	Medium to finish cutting	M	Application areas	Finish cutting	Medium to finish cutting	H	Application areas	Precision finishing
	Grade	SH725	SH725		Grade	SH725	SH725		Grade	BXA10
	Breaker Shape	JSS	JS		Breaker Shape	JSS	JS		Breaker Shape	HP
Cutting conditions		G094		Cutting conditions		G094		Cutting conditions		B026

For Small CNC lathes

P	Application areas	Finish cutting	Medium cutting	M	Application areas	Finish cutting	Medium cutting	N	Application areas	Medium to finish cutting	
	Grade	AH725	AH725		Grade	AH8015	AH8015		Grade	KS05F	KS05F
	Breaker Shape	SS	TS		Breaker Shape	SS	TS		Breaker Shape	SS	TS
Cutting conditions		G094		Cutting conditions		G094		Cutting conditions		B022	

Reference pages : JSCLCR-F: Inserts → **B157** -, CBN → **B210**, Standard cutting conditions → **G094**

Grade
Insert
Toolholder
Ext. Toolholder
Int. Toolholder
Threading
Grooving
Miniature tool
Milling cutter
Endmill
Drilling tool
Tooling System
User's Guide
Index



MINIFORCE

QC12-JSWL2XR

Screw-on modular head with 95° approach angle, for WXGU inserts

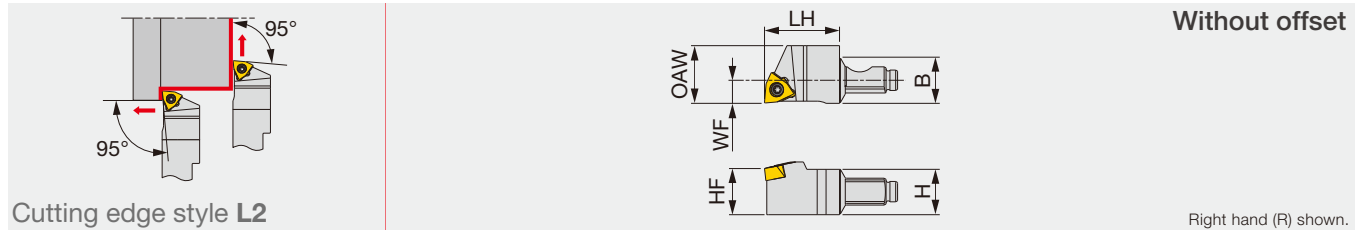

Designation	H	B	LH	HF	WF	OAW	RE**	Insert	Torque*
QC12-JSWL2XR04	12	12	19.5	12	6	15	0.2	WXGU0403**L...	0.9

Torque*: Recommended clamping torque (N·m)
 RE**: Standard corner radius
 Use right-hand toolholders (R) with left-hand inserts (L).

QC12-JSWL2XR-CHP

Screw-on modular head with 95° approach angle, for WXGU inserts, with high pressure coolant capability

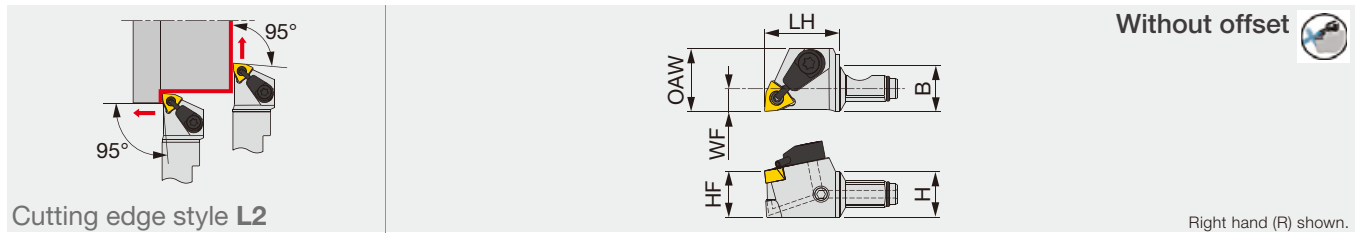

Designation	H	B	LH	HF	WF	OAW	RE**	Insert	Torque*
QC12-JSWL2XR04-CHP	12	12	19.5	12	6	16.5	0.2	WXGU0403**L...	0.9

Torque*: Recommended clamping torque (N·m)
 RE**: Standard corner radius
 Use right-hand toolholders (R) with left-hand inserts (L).

JSWL2XR/L

Screw-on toolholder with 95° approach angle, for WXGU inserts

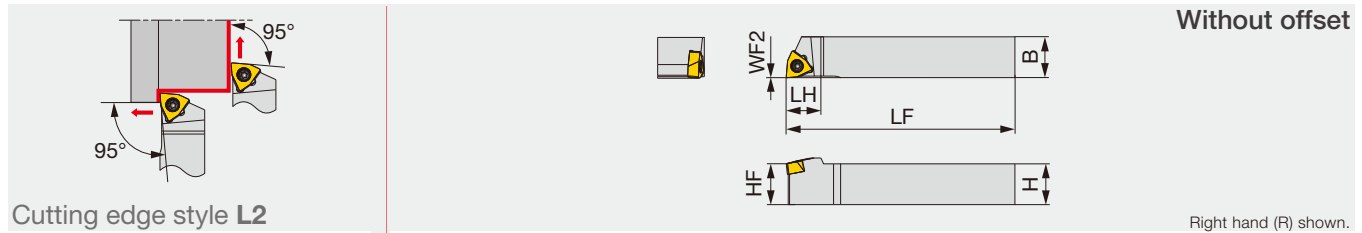

Designation	H	B	LF	LH	HF	WF2	RE**	Insert	Torque*
JSWL2XR/L1010X04	10	10	120	11	10	0	0.2	WXGU0403**L/R...	0.9
JSWL2XR/L1212F04	12	12	85	11	12	0	0.2	WXGU0403**L/R...	0.9
JSWL2XR/L1212X04	12	12	120	11	12	0	0.2	WXGU0403**L/R...	0.9
JSWL2XR/L1616X04	16	16	120	13	16	0	0.2	WXGU0403**L/R...	0.9
JSWL2XR/L2020H04	20	20	100	13	20	0	0.2	WXGU0403**L/R...	0.9

Torque*: Recommended clamping torque (N·m)
 RE**: Standard corner radius
 Use right-hand toolholders (R) with left-hand inserts (L); and left-hand toolholders (L) with right-hand inserts (R).

SPARE PARTS

Designation	Clamping screw 1	Coolant unit	Wrench 1	O-ring
QC12-JSWL2XR04-CHP	SR34-514	S-CU-CHP	T-7F	ORSS-0454.5X1.0NBR70
QC12-JSWL2XR04 JSWL2XR/L...	SR34-514	-	T-7F	-

Reference pages : QC12-JSWL2XR, QC12-JSWL2XR-CHP, JSWL2XR/L: Inserts → **B157 -**, CBN → **B210**
 Shank, Accessory → **G095, G096**, Standard cutting conditions → **G094**

JPWL2XR/L

Lever-lock toolholder with 95° approach angle, for WXGU inserts

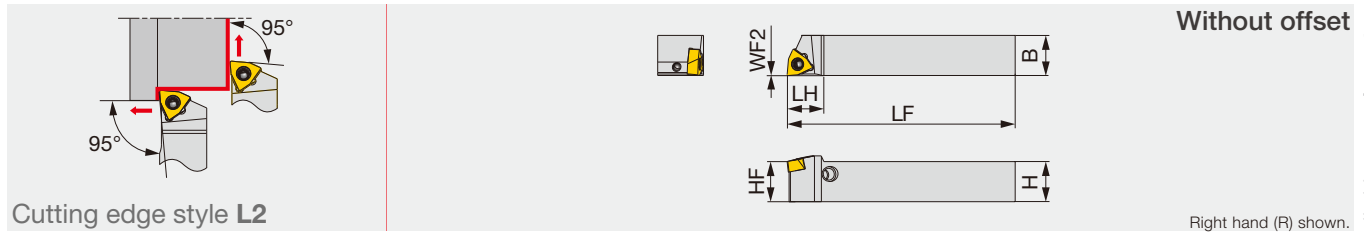

Cutting edge style L2

Designation	H	B	LF	LH	HF	WF2	RE**	Insert	Torque*
JPWL2XR/L1010X04	10	10	120	11	10	0	0.2	WXGU0403**L/R...	0.9
JPWL2XR/L1212F04	12	12	85	11	12	0	0.2	WXGU0403**L/R...	0.9
JPWL2XR/L1212X04	12	12	120	11	12	0	0.2	WXGU0403**L/R...	0.9
JPWL2XR/L1616X04	16	16	120	13	16	0	0.2	WXGU0403**L/R...	0.9

Torque*: Recommended clamping torque (N-m)

RE**: Standard corner radius

Use right-hand toolholders (R) with left-hand inserts (L); and left-hand toolholders (L) with right-hand inserts (R).

SPARE PARTS

Designation	Clamping screw 1	Lever	Pin	Clamping screw 2	Wrench 1	Wrench 2
JSWL2XR/L...	SR34-514	-	-	-	T-7F	-
JPWL2XR/L...	-	SLLV-2	SL-PI-2	SR10400611	-	HW2.0/5RED

INSERT SELECTION

For Swiss lathes

P	Application areas	Finish cutting	Medium to finish cutting	M	Application areas	Finish cutting	Medium to finish cutting	H	Application areas	Precision finishing
	Grade	SH725	SH725		Grade	SH725	SH725		Grade	HP
	JSS		JS		JSS		JS			
	Breaker Shape				Breaker Shape				Breaker Shape	
	Cutting conditions	G094			Cutting conditions	G094			Cutting conditions	B026

For Small CNC lathes

P	Application areas	Finish cutting	Medium cutting	M	Application areas	Finish cutting	Medium cutting	N	Application areas	Medium to finish cutting
	Grade	AH725	AH725		Grade	AH8015	AH8015		Grade	KS05F
	SS		TS		SS		TS		SS	TS
	Breaker Shape				Breaker Shape				Breaker Shape	
	Cutting conditions	G094			Cutting conditions	G094			Cutting conditions	B022

Reference pages : JPWL2XR/L: Inserts → B157 -, CBN → B210, Standard cutting conditions → G094

Grade
Insert
Toolholder
Ext. Toolholder
Int. Toolholder
Threading
Grooving
Miniature tool
Milling cutter
Endmill
Drilling tool
Tooling System
User's Guide
Index



Screw-on toolholder without offset, 95° approach angle, for WXGU inserts, high pressure coolant compatible

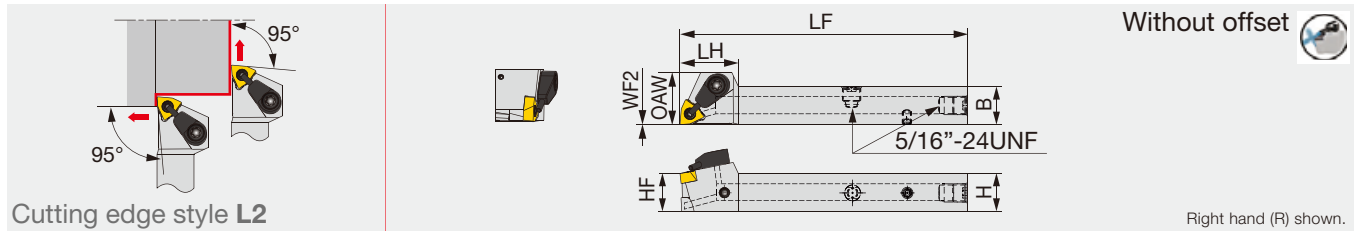

Cutting edge style L2

Right hand (R) shown.

Designation	H	B	LF	LH	HF	WF2	OAW	RE**	Insert	Torque*
JSWL2XR1212X04-CHP	12	12	120	18.5	12	0	16.5	0.2	WXGU0403**L	0.9
JSWL2XR1616X04-CHP	16	16	120	18.5	16	0	16.5	0.2	WXGU0403**L	0.9

Tube connection

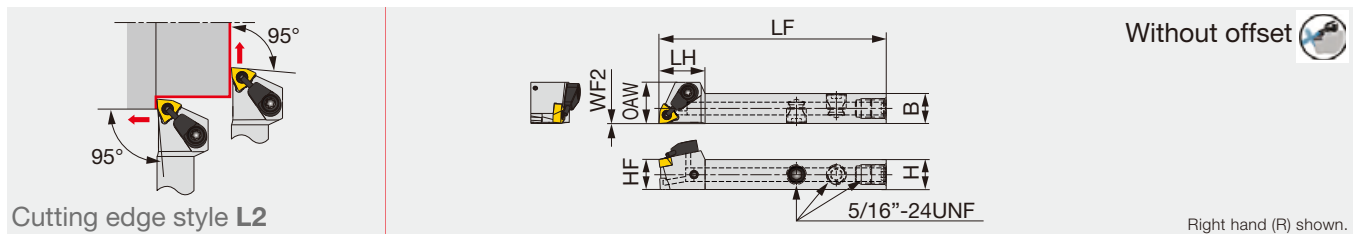

Cutting edge style L2

Right hand (R) shown.

Designation	H	B	LF	LH	HF	WF2	OAW	RE**	Insert	Torque*
JSWL2XR/L1212F04-CHP	12	12	85	18	12	0	16.5	0.2	WXGU0403**L/R...	0.9

Torque*: Recommended clamping torque (N·m)

RE**: Standard corner radius

Note: Right-hand toolholders (R) are used with left-hand inserts (L). Left-hand toolholders (L) are used with right-hand inserts (R).

SPARE PARTS

Designation	Clamping screw	Coolant unit	Wrench	Coolant plug	Wrench	DirectJet plug	Wrench
JSWL2XR**04-CHP	SR34-514	S-CU-CHP	T-7F	SR5/16UNFTL360	P-4	SSHM4-6-TB	P-2
JSWL2XR/L1212F04-CHP	SR34-514	S-CU-CHP	T-7F	SR5/16UNFTL360	P-4	-	-

INSERT SELECTION

For Swiss lathes

Application areas	Finish cutting	Medium to finish cutting	Application areas	Finish cutting	Medium to finish cutting	Application areas	Precision finishing
Grade	SH725	SH725	Grade	SH725	SH725	Grade	BXA10
Breaker Shape	JSS	JS	Breaker Shape	JSS	JS	Breaker Shape	HP
Breaking conditions	G094		Breaking conditions	G094		Breaking conditions	B026

For Small CNC lathes

Application areas	Finish cutting	Medium cutting	Application areas	Finish cutting	Medium cutting	Application areas	Medium to finish cutting
Grade	AH725	AH725	Grade	AH8015	AH8015	Grade	KS05F
Breaker Shape	SS	TS	Breaker Shape	SS	TS	Breaker Shape	SS
Breaking conditions	G094		Breaking conditions	G094		Breaking conditions	B022

Reference pages : JSWL2XR/L-CHP: Inserts → B157 -, CBN → B210
Standard cutting conditions → G094

JSWLXR-F

Screw-on stepped-head toolholder with 95° approach angle, for WXGU inserts

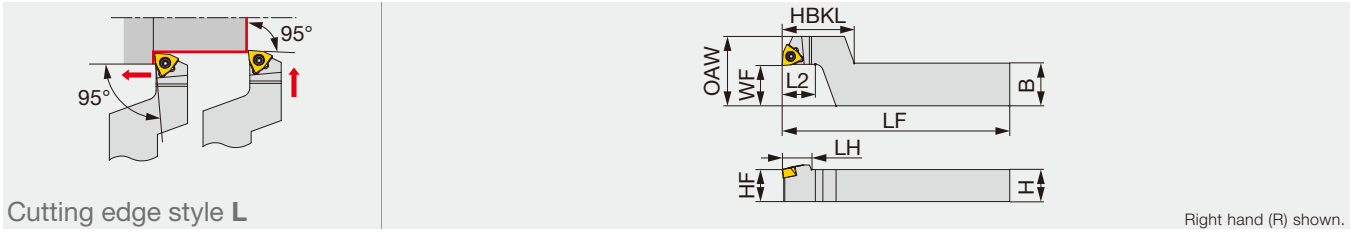

Right hand (R) shown.

Designation	H	B	LF	L2	HBKL	LH	HF	WF	OAW	RE**	Insert	Torque*
JSWLXR1016X04-F15	10	16	120	12	27	11	10	15	26	0.2	WXGU0403**L...	0.9
JSWLXR1216F04-F15	12	16	85	12	27	11	12	15	26	0.2	WXGU0403**L...	0.9
JSWLXR1216X04-F15	12	16	120	12	27	11	12	15	26	0.2	WXGU0403**L...	0.9
JSWLXR1620X04-F15	16	20	120	12	27	11	16	15	26	0.2	WXGU0403**L...	0.9

Torque*: Recommended clamping torque (N-m) RE**: Standard corner radius
Use right-hand toolholders (R) with left-hand inserts (L).

SPARE PARTS

Designation	Clamping screw	Wrench
JSWLXR**-F15	SR34-514	T-7F

INSERT SELECTION

For Swiss lathes

P	Application areas	Finish cutting	Medium to finish cutting	M	Application areas	Finish cutting	Medium to finish cutting	H	Application areas	Precision finishing
	Grade	SH725	SH725		Grade	SH725	SH725		Grade	BXA10
	Breaker Shape	JSS	JS		Breaker Shape	JSS	JS		Breaker Shape	HP
	Cutting conditions	G094			Cutting conditions	G094			Cutting conditions	B026

For Small CNC lathes

P	Application areas	Finish cutting	Medium cutting	M	Application areas	Finish cutting	Medium cutting	N	Application areas	Medium to finish cutting	
	Grade	AH725	AH725		Grade	AH8015	AH8015		Grade	KS05F	KS05F
	Breaker Shape	SS	TS		Breaker Shape	SS	TS		Breaker Shape	SS	TS
	Cutting conditions	G094			Cutting conditions	G094			Cutting conditions	B022	

Reference pages : JSWLXR-F: Inserts → B157 -, CBN → B210, Standard cutting conditions → G094



Lever-lock toolholder with 95° approach angle, for negative 80° rhombic inserts

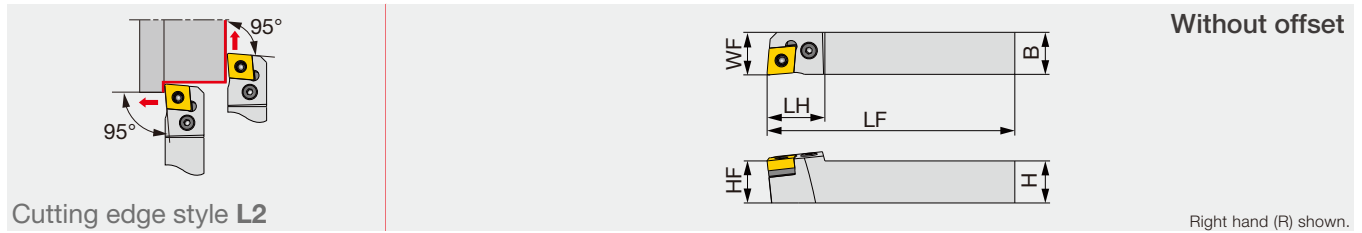

Cutting edge style L2

Designation	H	B	LF	LH	HF	WF	RE**	Insert	Torque*
PCL2NR2020H12	20	20	100	26	20	20	0.8	CN/GN**1204...	3

Torque*: Recommended clamping torque (N·m)
RE**: Standard corner radius

SPARE PARTS

Designation	Shim	Clamping screw	Lever	Spring pin	Wrench
PCL2NR2020H12	LSC42	LCS4	LCL4	LSP4	P-3

PCLNR

Lever-lock toolholder with 95° approach angle, for negative 80° rhombic inserts

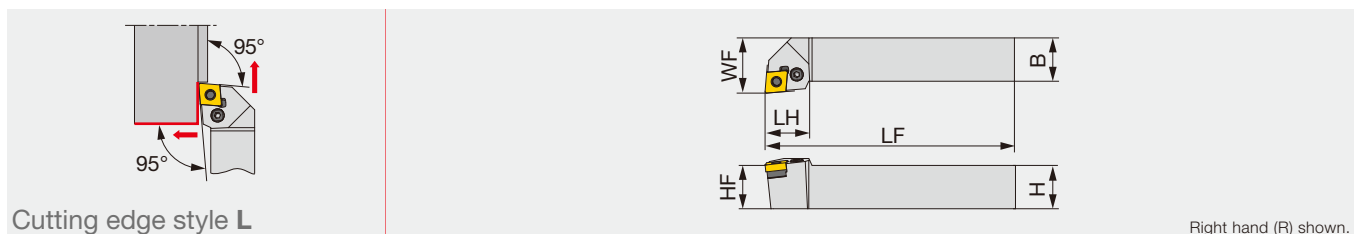

Cutting edge style L

Designation	H	B	LF	LH	HF	WF	RE**	Insert	Torque*
PCLNR2020H12	20	20	100	26	20	25	0.8	CN/GN**1204...	3

Torque*: Recommended clamping torque (N·m)
RE**: Standard corner radius

SPARE PARTS

Designation	Shim	Clamping screw	Lever	Spring pin	Wrench
PCLNR2020H12	LSC42	LCS4	LCL4	LSP4	P-3

INSERT SELECTION

P	Application areas	Precision finishing	Finish cutting	Medium cutting	Medium to heavy cutting	M	Application areas	Finish cutting	Medium cutting	Medium to heavy cutting
	Grade	NS9530	GT9530	T9215	T9215		Grade	T6215	AH6225	AH6225
	Breaker Shape	TF	TSF	TM	TH		Breaker Shape	SF	SM	SH
	Cutting conditions	B004					Cutting conditions	B006		
K	Application areas	Finish cutting	Medium cutting	Medium to heavy cutting	N	Application areas	Finish cutting	Medium cutting		
	Grade	T515	T515	T515		Grade	DX110	TH10	KS05F	
	Breaker Shape	All-round	All-round	All-round		Breaker Shape	DIA	P	28	
	Cutting conditions	B008				Cutting conditions	B010			
S	Application areas	Precision finishing	Finish cutting	Medium cutting	H	Application areas	Precision finishing			
	Grade	BX950	AH8005	AH8005		Grade	HP	BXA10		
	Breaker Shape	CBN	HRF	HRM		Breaker Shape	HP			
	Cutting conditions	B012				Cutting conditions	B014			

Reference pages : PCL2NR, PCLNR: Inserts → B054 -, CBN → B168 -, PCD → B211

JTTLNR/L

Back-clamp toolholder with 95° approach angle, for negative 60° triangular inserts

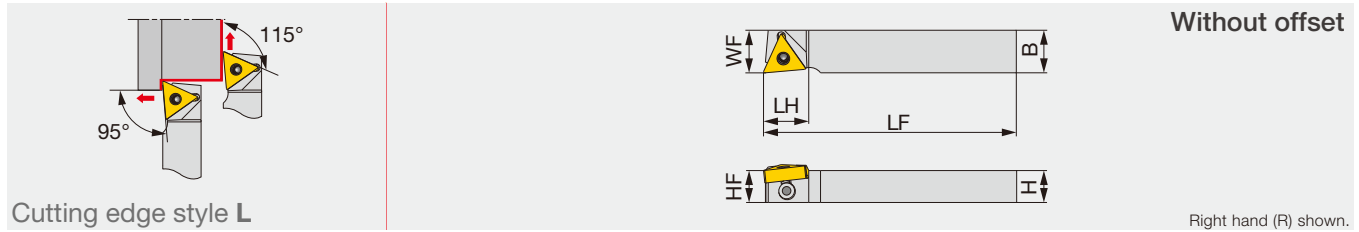

Designation	H	B	LF	LH	HF	WF	RE**	Insert	Torque*
JTTLNR/L1216F16	12	16	85	17	12	16	0.4	TN**1604...	1
JTTLNR/L1216X16	12	16	120	17	12	16	0.4	TN**1604...	1
JTTLNR/L1616X16	16	16	120	17	16	16	0.4	TN**1604...	1

Torque*: Recommended clamping torque (N-m)
RE**: Standard corner radius

PTL2NR/L

Lever-lock toolholder with 95° approach angle, for negative 60° triangular inserts

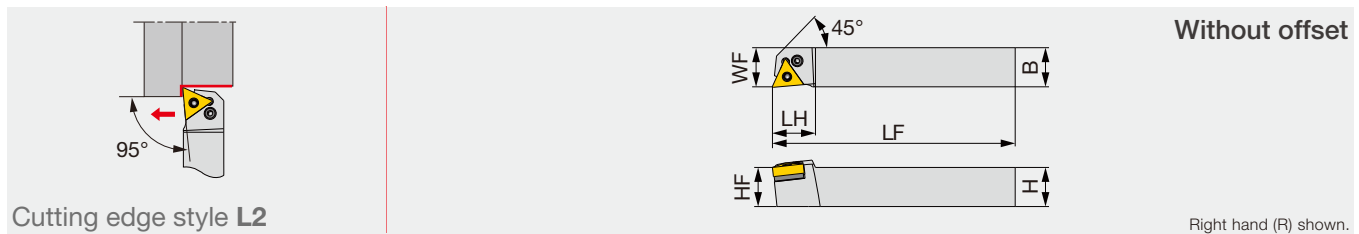

Designation	H	B	LF	LH	HF	WF	RE**	Insert	Torque*
PTL2NR/L2020H16	20	20	100	22	20	20	0.4	TN**1604...	2

Torque*: Recommended clamping torque (N-m)
RE**: Standard corner radius

Designation	Clamp	Shim	Clamping screw	Clamping screw 1	Wrench	Wrench 1	Spring pin	Lever
JTTLNR/L...	JCP-3N	-	JDS-5040	-	P-2.5F	-	-	-
PTL2NR/L...	-	LST317 D30	-	LCS3	-	P-2.5	LSP3	LCL3

INSERT SELECTION

P	Application areas	Precision finishing	Finish cutting		Medium cutting	M	Application areas	Precision finishing	Finish cutting	Medium cutting	
	Grade	SH725	SH725	GT9530	T9215		Grade	SH725	SH725	AH6225	
	Breaker Shape	01	JRP	TSF	TM		Breaker Shape	01	JRP	SM	
	Cutting conditions	G094		B004			Cutting conditions	G094		B006	
P	Application areas	Medium to heavy cutting		K	Application areas	Finish cutting	Medium cutting	Medium to heavy cutting			
	Grade	T9215			Grade	T515	T515	T515			
	Breaker Shape	TH			Breaker Shape	All-round	All-round	All-round			
	Cutting conditions	B004			Cutting conditions	B008					
N	Application areas	Precision finishing	Finish cutting	Medium cutting		S	Application areas	Precision finishing	Finish cutting	Medium cutting	
	Grade	DX110	DX140	TH10	28		KS05F	Grade	BX950	AH8005	AH8005
	Breaker Shape	DIA	with rake DIA	P			Breaker Shape	CBN	HRF	HRM	
	Cutting conditions	B010						Cutting conditions	B012		
H	Application areas	Precision finishing	Finish cutting								
	Grade	BXA10	BXA10								
	Breaker Shape	HP	CBN								
	Cutting conditions	B014									

Reference pages : JTTLNR/L, PTL2NR/L: Inserts → B087 -, CBN → B182 -, PCD → B212

Screw-on Y-axis turning modular head with 93° approach angle, for positive 55° rhombic inserts

Cutting edge style **J2**

Without offset

Right hand (R) shown.

Designation	H	B	LH	HF	WF	LB	H2	DISTX	RE**	Insert	Torque*
QC12-JSDJ2CR11-Y	12	12	19.5	0	6	19.8	18.7	0.3	0.2	DC**11T3...	1.2

Torque*: Recommended clamping torque (N·m)
RE**: Standard corner radius

QC12-JSDJ2CR-Y-CHP

Screw-on Y-axis turning modular head with 93° approach angle, for positive 55° rhombic inserts, with high pressure coolant capability

Cutting edge style **J2**

Without offset

Right hand (R) shown.

Designation	H	B	LH	HF	WF	LB	H2	DISTX	RE**	Insert	Torque*
QC12-JSDJ2CR11-Y-CHP	12	12	19.5	0	6	19.8	18.7	0.3	0.2	DC**11T3...	1.2

Torque*: Recommended clamping torque (N·m)
RE**: Standard corner radius

SPARE PARTS

Designation	Clamping screw	Wrench	O-ring
QC12-JSDJ2CR11-Y, QC12-JSDJ2CR11	CSTB-4SD	T-8F	-
QC12-JSDJ2CR11-Y-CHP	CSTB-4SD	T-8F	ORSS-0454.5X1.0NBR70

INSERT SELECTION

<p>P Application areas: Precision finishing, Finish cutting, Medium to finish cutting</p> <p>Grade: SH725, SH725, SH725, SH725</p> <p>Breaker Shape: 01, JP, JS, JS</p> <p>Cutting conditions: G094</p>	<p>M Application areas: Precision finishing, Finish cutting, Medium to finish cutting</p> <p>Grade: SH725, SH725, SH725, SH725</p> <p>Breaker Shape: 01, JP, JS, JS</p> <p>Cutting conditions: G094</p>
<p>P Application areas: Medium to finish cutting</p> <p>Grade: SH725</p> <p>Breaker Shape: 01</p> <p>Cutting conditions: G094</p>	<p>M Application areas: Medium to finish cutting</p> <p>Grade: SH725</p> <p>Breaker Shape: 01</p> <p>Cutting conditions: G094</p>
<p>K Application areas: Medium to finish cutting</p> <p>Grade: T515</p> <p>Breaker Shape: CM</p> <p>Cutting conditions: B020</p>	<p>N Application areas: Precision finishing, Medium cutting</p> <p>Grade: DX110, KS05F</p> <p>Breaker Shape: NS, AL</p> <p>Cutting conditions: B022</p>
<p>S Application areas: Finish cutting, Medium to finish cutting</p> <p>Grade: SH725, SH725</p> <p>Breaker Shape: JS, JS</p> <p>Cutting conditions: G094</p>	<p>H Application areas: Precision finishing, Finish cutting</p> <p>Grade: BXA10, BXA20</p> <p>Breaker Shape: CBN, CBN</p> <p>Cutting conditions: B026</p>

Reference pages : QC12-JSDJ2CR-Y, QC12-JSDJ2CR-Y-CHP: Inserts → **B121 -**, CBN → **B193 -**, PCD → **B214**
Shank, Accessory → **G095, G096**

QC12-JSDJ2CR

Screw-on modular head with 93° approach angle, for positive 55° rhombic inserts

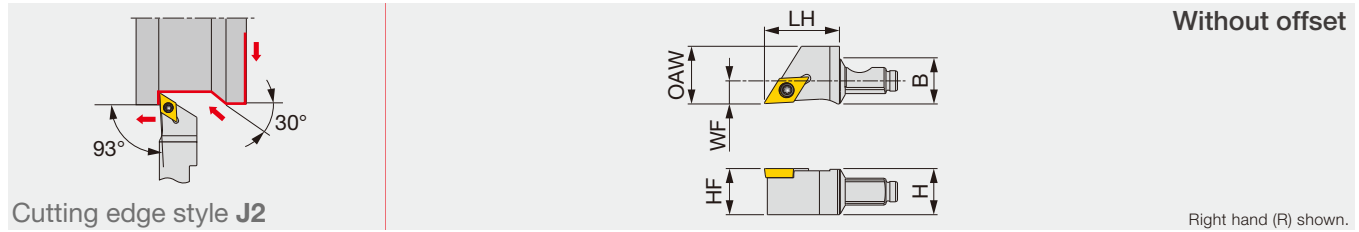

Designation	H	B	LH	HF	WF	OAW	RE**	Insert	Torque*
QC12-JSDJ2CR07	12	12	19.5	12	6	15	0.2	DC**0702...	1.2
QC12-JSDJ2CR11	12	12	19.5	12	6	15	0.2	DC**11T3...	1.2

Torque*: Recommended clamping torque (N·m)
RE**: Standard corner radius

QC12-JSDJ2CR-CHP

Screw-on modular head with 93° approach angle, for positive 55° rhombic inserts, with high pressure coolant capability

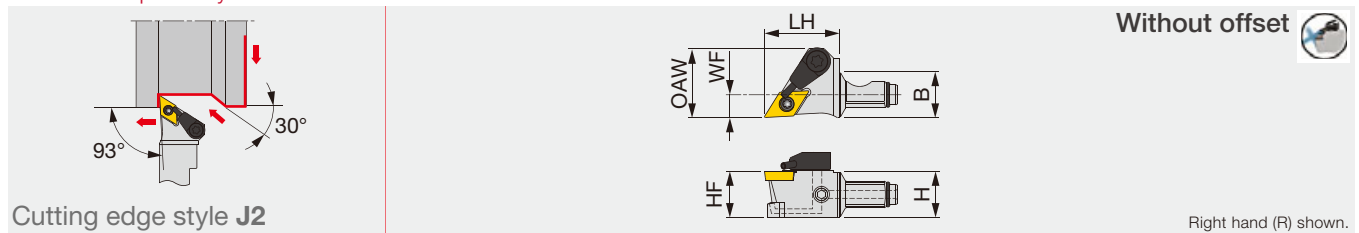

Designation	H	B	LH	HF	WF	OAW	RE**	Insert	Torque*
QC12-JSDJ2CR07-CHP	12	12	19.5	12	6	18	0.2	DC**0702...	1.2
QC12-JSDJ2CR11-CHP	12	12	19.5	12	6	21	0.2	DC**11T3...	1.2

Torque*: Recommended clamping torque (N·m)
RE**: Standard corner radius

SPARE PARTS

Designation	Clamping screw	Coolant unit	Wrench	O-ring
QC12-JSDJ2CR07	CSTB-2.5	-	T-8F	-
QC12-JSDJ2CR07-CHP	CSTB-2.5	S-CU-CHP	T-8F	ORSS-0454.5X1.0NBR70
QC12-JSDJ2CR11-CHP	CSTB-4SD	S-CU-CHP	T-8F	ORSS-0454.5X1.0NBR70

INSERT SELECTION

P	Application areas	Precision finishing		Finish cutting	Medium to finish cutting	M	Application areas	Precision finishing		Finish cutting	Medium to finish cutting
	Grade	SH725	SH725	SH725	SH725		Grade	SH725	SH725	SH725	SH725
	Breaker Shape	01	JP	JS	JS		Breaker Shape	01	JP	JS	JS
	Cutting conditions	G094					Cutting conditions	G094			
P	Application areas	Medium to finish cutting		M	Application areas	Medium to finish cutting		N	Application areas	Precision finishing	Medium cutting
	Grade	SH725			Grade	SH725			Grade	DX110	KS05F
	Breaker Shape	01			Breaker Shape	01			Breaker Shape	NS	AL
	Cutting conditions	G094			Cutting conditions	G094			Cutting conditions	B022	
K	Application areas	Medium to finish cutting		S	Application areas	Finish cutting	Medium to finish cutting	H	Application areas	Precision finishing	Finish cutting
	Grade	T515			Grade	SH725	SH725		Grade	BXA10	BXA20
	Breaker Shape	CM			Breaker Shape	JS	JS		Breaker Shape	CBN	CBN
	Cutting conditions	B020			Cutting conditions	G094			Cutting conditions	B026	

Reference pages : QC12-JSDJ2CR, QC12-JSDJ2CR-CHP: Inserts → **B121 -**, CBN → **B193 -**, PCD → **B214**,
Shank, Accessory → **G095, G096**

Screw-on toolholder with 93° approach angle, for positive 55° rhombic inserts

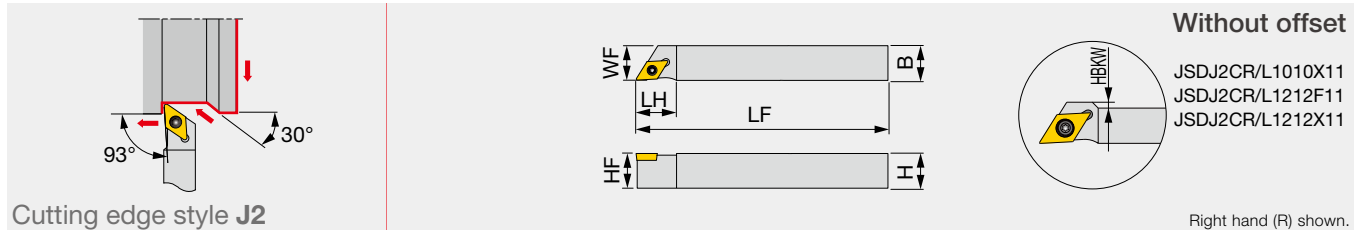

Cutting edge style J2

Right hand (R) shown.

Designation	H	B	LF	LH	HF	WF	HBKW	RE**	Insert	Torque*
JSDJ2CR/L0808F07	8	8	85	14	8	8	-	0.2	DC**0702...	1.2
JSDJ2CR/L1010X07	10	10	120	14	10	10	-	0.2	DC**0702...	1.2
JSDJ2CR/L1010X11	10	10	120	20	10	10	4	0.2	DC**11T3...	1.2
JSDJ2CR/L1212F07	12	12	85	14	12	12	-	0.2	DC**0702...	1.2
JSDJ2CR/L1212F11	12	12	85	20	12	12	2	0.2	DC**11T3...	1.2
JSDJ2CR/L1212X07	12	12	120	14	12	12	-	0.2	DC**0702...	1.2
JSDJ2CR/L1212X11	12	12	120	20	12	12	2	0.2	DC**11T3...	1.2
JSDJ2CR/L1616X11	16	16	120	20	16	16	-	0.2	DC**11T3...	1.2

Torque*: Recommended clamping torque (N-m)
RE**: Standard corner radius

JTDJ2CR/L

Back-clamp toolholder with 93° approach angle, for positive 55° rhombic inserts

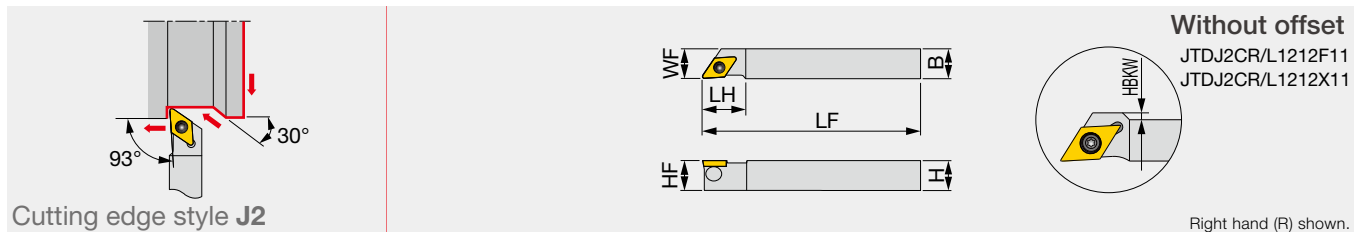

Cutting edge style J2

Right hand (R) shown.

Designation	H	B	LF	LH	HF	WF	HBKW	RE**	Insert	Torque*
JTDJ2CR/L1010X07	10	10	120	14	10	10	-	0.2	DC**0702...	0.9
JTDJ2CR/L1212F07	12	12	85	14	12	12	-	0.2	DC**0702...	0.9
JTDJ2CR/L1212X07	12	12	120	14	12	12	-	0.2	DC**0702...	0.9
JTDJ2CR/L1212F11	12	12	85	20	12	12	2	0.2	DC**11T3...	1.2
JTDJ2CR/L1212X11	12	12	120	20	12	12	2	0.2	DC**11T3...	1.2
JTDJ2CR/L1616X11	16	16	120	20	16	16	-	0.2	DC**11T3...	1.2

Torque*: Recommended clamping torque (N-m)
RE**: Standard corner radius

SPARE PARTS

Designation	Clamping screw	Clamp	Clamping screw	Wrench 1	Wrench 2 (Optional)
JSDJ2CR/L**07	CSTB-2.5	-	-	T-8F	(T-8L)
JSDJ2CR/L**11	CSTB-4SD	-	-	T-8F	(T-8L)
JTDJ2CR/L**07	-	JCP-2	JDS-3525	P-2F	-
JTDJ2CR/L**11	-	JCP-3	JDS-5040	P-2.5F	-

Reference pages : JSDJ2CR/L, JTDJ2CR/L: Inserts → **B121 -**, CBN → **B193 -**, PCD → **B214**,
Shank, Accessory → **G095, G096**

JSDJ2CR-CHP

Direct connection

Screw-on toolholder without offset, 93° approach angle for positive 55° rhombic inserts, high pressure coolant compatible

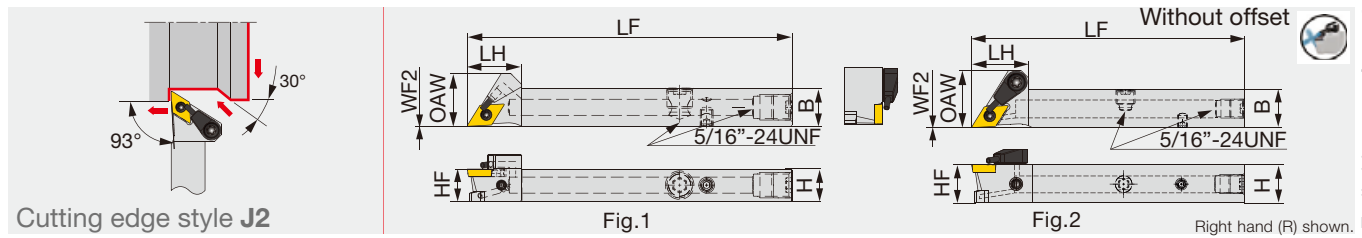

Designation	H	B	LF	LH	HF	WF2	OAW	RE**	Insert	Torque*	Fig.
JSDJ2CR1012H07-CHP	10	12	100	17	10	0	16.4	0.2	DC**0702	1.2	1
JSDJ2CR1212X11-CHP	12	12	120	19	12	0	20.5	0.2	DC**11T3	1.2	2
JSDJ2CR1616X11-CHP	16	16	120	19	16	0	20.5	0.2	DC**11T3	1.2	2

Torque*: Recommended clamping torque (N·m) RE**: Standard corner radius

SPARE PARTS

Designation	Clamping screw	Coolant nozzle	Nozzle retainer screw	Wrench	Coolant plug	Wrench	DirectJet plug	Wrench
JSDJ2CR1012H07-CHP	CSTB-2.5	NZ-1.10-7-CHP	SSHM4-4-TB	T-8F	SR5/16UNFTL360	P-4	SSHM4-6-TB	P-2
Designation	Clamping screw	Coolant unit	Wrench	Coolant plug	Wrench	DirectJet plug	Wrench	
JSDJ2CR**11-CHP	CSTB-4SD	S-CU-CHP	T-8F	SR5/16UNFTL360	P-4	SSHM4-6-TB	P-2	

INSERT SELECTION

P	Application areas	Precision finishing	Finish cutting	Medium to finish cutting	M	Application areas	Precision finishing	Finish cutting	Medium to finish cutting	
	Grade	SH725	SH725	SH725		SH725	SH725	SH725	SH725	
	Breaker Shape	01	JP	JS	JS	01	JS	JS	JS	
	Cutting conditions	G094					G094			
P	Application areas	Medium to finish cutting			M	Application areas	Medium to finish cutting			
	Grade	SH725				SH725				
	Breaker Shape	01			01					
	Cutting conditions	G094				G094				
K	Application areas	Medium to finish cutting			N	Application areas	Precision finishing	Medium cutting		
	Grade	T515				NS	DX110	AL	KS05F	
	Breaker Shape	CM								
	Cutting conditions	B020				B022				
S	Application areas	Finish cutting	Medium to finish cutting		H	Application areas	Precision finishing	Finish cutting		
	Grade	SH725	SH725			Grade	BXA10	BXA20		
	Breaker Shape	JS	JS		Breaker Shape	CBN	CBN			
	Cutting conditions	G094				B026				

Reference pages : JSDJ2CR-CHP: Inserts → **B121 -**, CBN → **B193 -**, PCD → **B214**
Shank, Accessory → **G095, G096**

Grade
Insert
Ext. Toolholder
Int. Toolholder
Threading
Grooving
Miniature tool
Milling cutter
Endmill
Drilling tool
Tooling System
User's Guide
Index

A
B
C
D
E
F
G
H
I
J
K
L
M

Screw-on toolholders without offset – 93° approach angle. For positive 55° rhombic insert. High-pressure coolant capability.

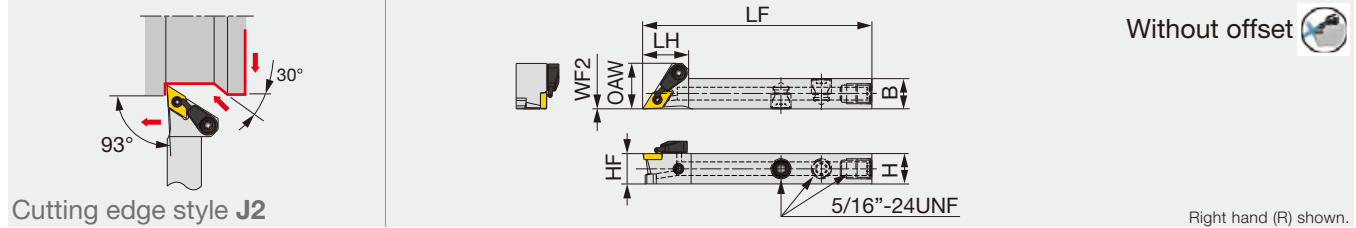

Designation	H	B	LF	LH	HF	WF2	OAW	RE**	Insert	Torque*
JSDJ2CR/L1212F07-CHP	12	12	85	18	12	0	18	0.2	DC**0702...	1.2
JSDJ2CR/L1212F11-CHP	12	12	85	19	12	0	20.5	0.2	DC**11T3...	1.2

Torque*: Recommended clamping torque (N-m)
RE**: Standard corner radius



JSDJCR/L

Screw-on toolholder with 93° approach angle, for positive 55° rhombic inserts

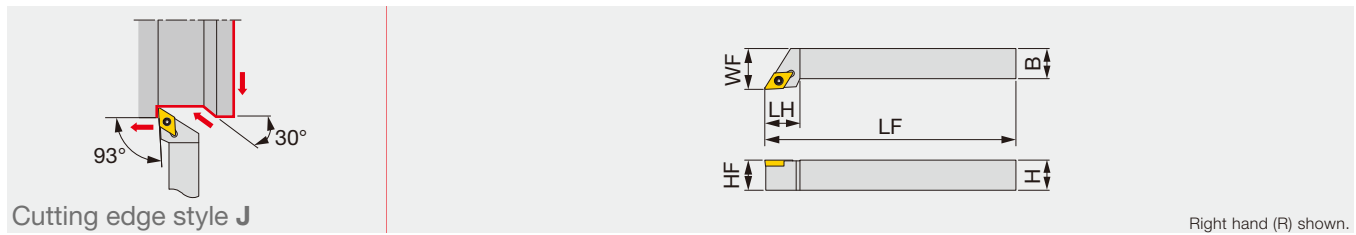

Designation	H	B	LF	LH	HF	WF	RE**	Insert	Torque*
JSDJCR/L0808H07	8	8	100	14	8	10	0.4	DC**0702...	1.2
JSDJCR/L1010H11	10	10	100	18	10	12	0.8	DC**11T3...	1.2
JSDJCR/L1212H07	12	12	100	14	12	16	0.4	DC**0702...	1.2
JSDJCR/L1212H11	12	12	100	18	12	16	0.8	DC**11T3...	1.2
JSDJCR/L1616H11	16	16	100	18	16	20	0.8	DC**11T3...	1.2

Torque*: Recommended clamping torque (N-m)
RE**: Standard corner radius



SPARE PARTS

Designation	Clamping screw	Coolant unit	Wrench 1	Wrench 2 (Optional)
JSDJ2CR/L1212F07-CHP	CSTB-2.5	S-CU-CHP	T-8F	-
JSDJ2CR/L1212F11-CHP	CSTB-4SD	S-CU-CHP	T-8F	-



Reference pages : JSDJ2CR/L-CHP, JSDJCR/L: Inserts → **B121 -**, CBN → **B193 -**, PCD → **B214**
Shank, Accessory → **G095, G096**

JSDJCR-F

Screw-on stepped-head toolholder with 93° approach angle, for positive 55° rhombic inserts

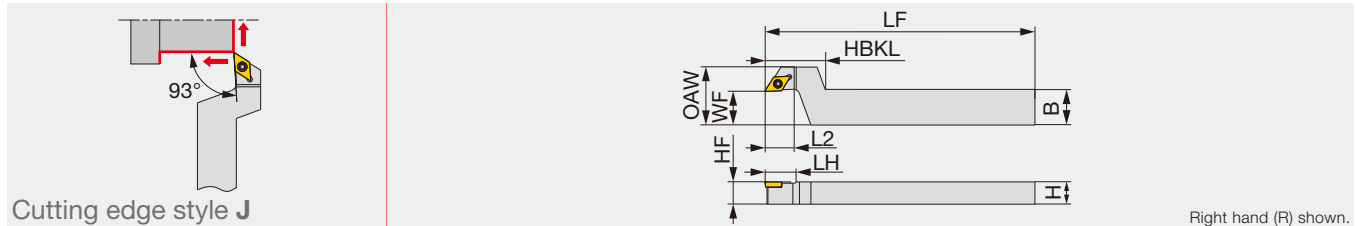

Designation	H	B	LF	L2	HBKL	LH	HF	WF	OAW	RE**	Insert	Torque*
JSDJCR1016X07-F15	10	16	120	12.5	27	14	10	15	26	0.2	DC**0702...	1.2
JSDJCR1216F07-F15	12	16	85	12.5	27	14	12	15	26	0.2	DC**0702...	1.2
JSDJCR1216X07-F15	12	16	120	12.5	27	14	12	15	26	0.2	DC**0702...	1.2
JSDJCR1216F11-F15	12	16	85	12.5	27	20	12	15	28	0.2	DC**11T3...	1.2
JSDJCR1216X11-F15	12	16	120	12.5	27	20	12	15	28	0.2	DC**11T3...	1.2
JSDJCR1620X11-F15	16	20	120	12.5	27	20	16	15	28	0.2	DC**11T3...	1.2

Torque*: Recommended clamping torque (N-m)
RE**: Standard corner radius

Designation	Clamping screw	Wrench 1	Wrench 2 (Optional)
JSDJC**H07, JSDJCR**07-F15	CSTB-2.5	T-8F	(T-8L)
JSDJC**H11, JSDJCR**11-F15	CSTB-4SD	T-8F	(T-8L)

INSERT SELECTION

P	Application areas	Precision finishing	Finish cutting	Medium to finish cutting	M	Application areas	Precision finishing	Finish cutting	Medium to finish cutting	
	Grade	SH725	SH725	SH725		SH725	SH725	SH725	SH725	SH725
	Breaker Shape	01	JP	JS	JS	01	JP	JS	JS	
	Cutting conditions	G094					G094			
P	Application areas	Medium to finish cutting			M	Application areas	Medium to finish cutting			
	Grade	SH725				Grade	SH725			
	Breaker Shape	01				01				
	Cutting conditions	G094			G094					
K	Application areas	Medium to finish cutting			N	Application areas	Precision finishing	Medium cutting		
	Grade	T515				Grade	DX110	KS05F		
	Breaker Shape	CM				NS	AL			
	Cutting conditions	B020			B022					
S	Application areas	Finish cutting	Medium to finish cutting			H	Application areas	Precision finishing	Finish cutting	
	Grade	SH725	SH725				Grade	BXA10	BXA20	
	Breaker Shape	JS	JS				CBN	CBN		
	Cutting conditions	G094			B026					

Reference pages : JSDJCR-F: Inserts → B121 -, CBN → B193 -, PCD → B214
Shank, Accessory → G095, G096



Screw-on Y-axis turning modular head with 93° approach angle, for DX*U inserts

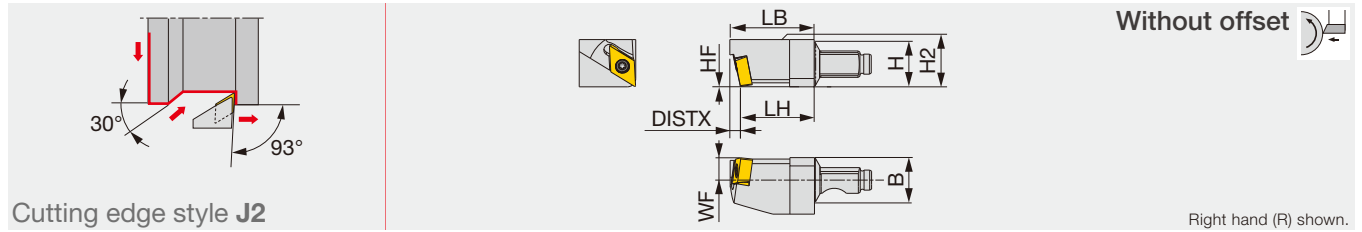

Designation	H	B	LH	HF	WF	LB	H2	DISTX	RE**	Insert	Torque*
QC12-JSDJ2XR07-Y	12	12	19.5	0	6	22.3	12.5	2.8	0.2	DX*U0703**L...	0.9

Torque*: Recommended clamping torque (N-m)
 RE**: Standard corner radius
 Use right-hand toolholders (R) with left-hand inserts (L).



QC12-JSDJ2XR-Y-CHP

Screw-on Y-axis turning modular head with 93° approach angle, for DX*U inserts, with high pressure coolant capability

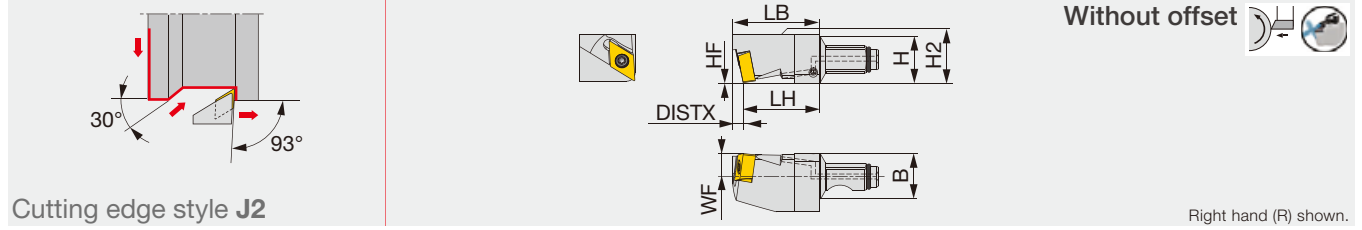

Designation	H	B	LH	HF	WF	LB	H2	DISTX	RE**	Insert	Torque*
QC12-JSDJ2XR07-Y-CHP	12	12	19.5	0	6	22.3	12.5	2.8	0.2	DX*U0703**L...	0.9

Torque*: Recommended clamping torque (N-m)
 RE**: Standard corner radius
 Use right-hand toolholders (R) with left-hand inserts (L).



QC12-JSDJ2XR

Screw-on modular head with 93° approach angle, for DX*U inserts

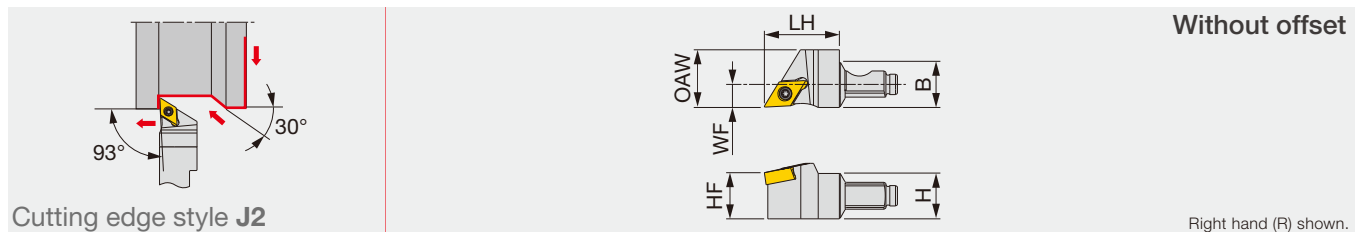

Designation	H	B	LH	HF	WF	OAW	RE**	Insert	Torque*
QC12-JSDJ2XR07	12	12	19.5	12	6	15	0.2	DX*U0703**L...	0.9

Torque*: Recommended clamping torque (N-m)
 RE**: Standard corner radius
 Use right-hand toolholders (R) with left-hand inserts (L).



SPARE PARTS

Designation	Clamping screw	Wrench	O-ring
QC12-JSDJ2XR07-Y	SR34-514	T-7F	-
QC12-JSDJ2XR07-Y-CHP, QC12-JSDJ2XR07	SR34-514	T-7F	ORSS-0454.5X1.0NBR70

Reference pages : QC12-JSDJ2XR-Y, QC12-JSDJ2XR-Y-CHP, QC12-JSDJ2XR: Inserts → **B126**
 Shank, accessory → **G095, G096**, Standard cutting conditions → **G094**

QC12-JSDJ2XR-CHP

Screw-on modular head with 93° approach angle, for DX*U inserts, with high pressure coolant capability

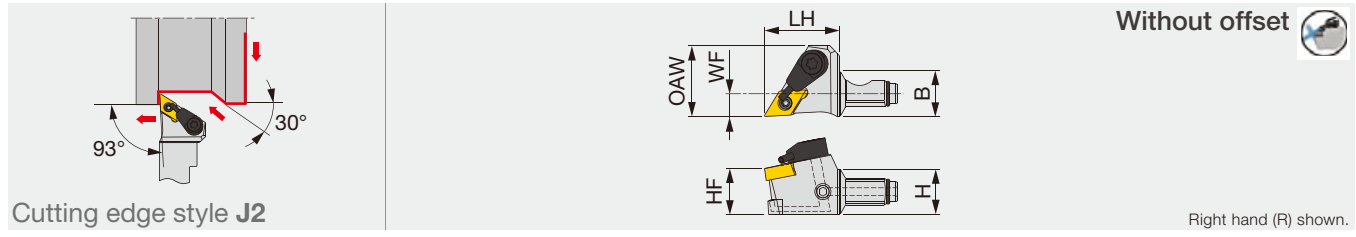

Designation	H	B	LH	HF	WF	OAW	RE**	Insert	Torque*
QC12-JSDJ2XR07-CHP	12	12	19.5	12	6	18.4	0.2	DX*U0703**L...	0.9

Torque*: Recommended clamping torque (N-m)
RE**: Standard corner radius
Use right-hand toolholders (R) with left-hand inserts (L).

JSDJ2XR/L

Screw-on toolholder with 93° approach angle, for DX*U inserts

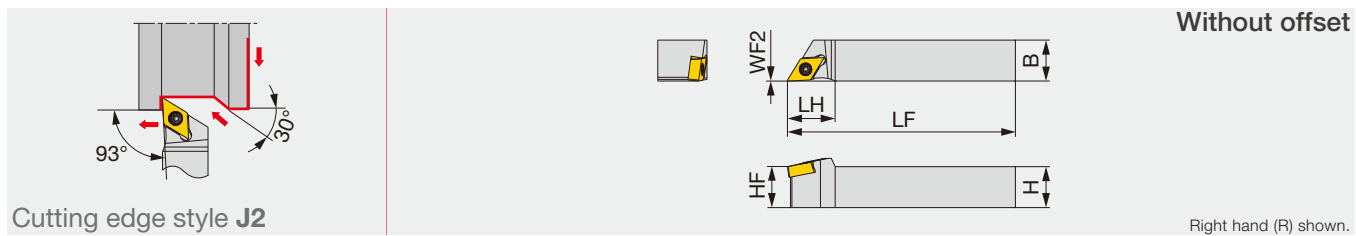

Designation	H	B	LF	LH	HF	WF2	RE**	Insert	Torque*
JSDJ2XR/L1010X07	10	10	120	14	10	0	0.2	DX*U0703**L/R...	0.9
JSDJ2XR/L1212F07	12	12	85	14	12	0	0.2	DX*U0703**L/R...	0.9
JSDJ2XR/L1212X07	12	12	120	14	12	0	0.2	DX*U0703**L/R...	0.9
JSDJ2XR/L1616X07	16	16	120	18	16	0	0.2	DX*U0703**L/R...	0.9
JSDJ2XR/L2020H07	20	20	100	18	20	0	0.2	DX*U0703**L/R...	0.9

Torque*: Recommended clamping torque (N-m) RE**: Standard corner radius
Use right-hand toolholders (R) with left-hand inserts (L); and left-hand toolholders (L) with right-hand inserts (R).

SPARE PARTS

Designation	Clamping screw	Coolant unit	Wrench	O-ring
QC12-JSDJ2XR07-CHP	SR34-514	S-CU-CHP	T-7F	ORSS-0454.5X1.0NBR70
JSDJ2XR/L...	SR34-514	-	T-7F	-

INSERT SELECTION

for Swiss lathes

Application areas	Finish cutting		Medium to finish cutting	Application areas	Finish cutting		Medium to finish cutting
	Grade	Grade			Grade	Grade	
	SH725	SH725	SH725		SH725	SH725	
Breaker Shape	JSS	JS	JSS	JS	JSS	JS	
Cutting conditions	G094			G094			

for Small CNC lathes

Application areas	Finish cutting		Medium cutting	Application areas	Finish cutting		Medium cutting	Application areas	Medium to finish cutting	
	Grade	Grade			Grade	Grade			Grade	Grade
	AH725	AH725	AH725		AH8015	AH8015	AH8015		KS05F	KS05F
Breaker Shape	SS	TS	SS	TS	SS	TS	SS	TS	SS	TS
Cutting conditions	G094			G094			B022			

Reference pages : QC12-JSDJ2XR-CHP, JSDJ2XR/L: Inserts → **B126**
Shank, accessory → **G095, G096**, Standard cutting conditions → **G094**

Lever-lock toolholder with 93° approach angle, for DX*U inserts

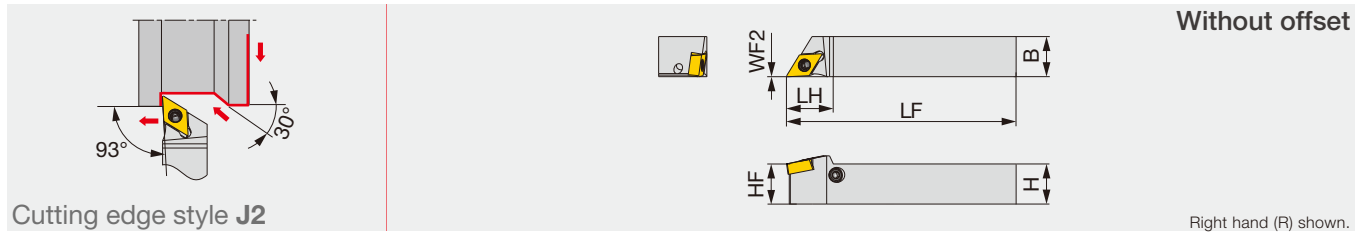

Cutting edge style J2

Right hand (R) shown.

Designation	H	B	LF	LH	HF	WF2	RE**	Insert	Torque*
JPDJ2XR/L1010X07	10	10	120	14	10	0	0.2	DX*U0703**L/R...	0.9
JPDJ2XR/L1212F07	12	12	85	14	12	0	0.2	DX*U0703**L/R...	0.9
JPDJ2XR/L1212X07	12	12	120	14	12	0	0.2	DX*U0703**L/R...	0.9
JPDJ2XR/L1616X07	16	16	120	18	16	0	0.2	DX*U0703**L/R...	0.9

Torque*: Recommended clamping torque (N-m) RE**: Standard corner radius

Use right-hand toolholders (R) with left-hand inserts (L); and left-hand toolholders (L) with right-hand inserts (R).



JSDJ2XR-CHP

Direct connection

Screw-on toolholder without offset, 93° approach angle, for DX*U inserts, high pressure coolant compatible

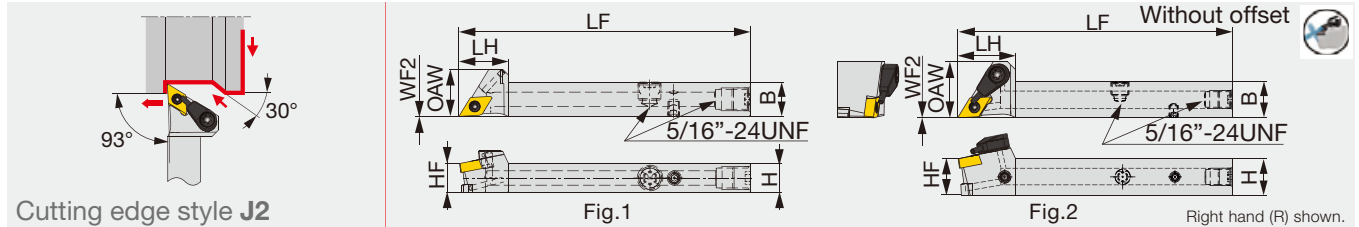

Cutting edge style J2

Right hand (R) shown.

Designation	H	B	LF	LH	HF	WF2	OAW	RE**	Insert	Torque*	Fig.
JSDJ2XR1012H07-CHP	10	12	100	17	10	0	14.7	0.2	DX*U0703**L	0.9	1
JSDJ2XR1212X07-CHP	12	12	120	19	12	0	18.5	0.2	DX*U0703**L	0.9	2
JSDJ2XR1616X07-CHP	16	16	120	19	16	0	18.5	0.2	DX*U0703**L	0.9	2



Tube connection

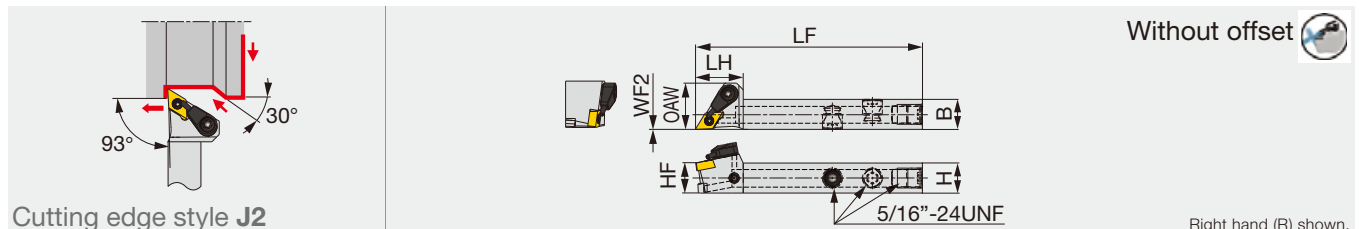

Cutting edge style J2

Right hand (R) shown.

Designation	H	B	LF	LH	HF	WF2	OAW	RE**	Insert	Torque*
JSDJ2XR/L1212F07-CHP	12	12	85	19	12	0	18.5	0.2	DX*U0703**L/R...	0.9

Torque*: Recommended clamping torque (N-m)

RE**: Standard corner radius

Right-hand toolholders (R) are used with left-hand inserts (L). Left-hand toolholders (L) are used with right-hand inserts (R).



SPARE PARTS

Designation	Lever	Pin	Clamping screw 1	Wrench 1	Clamping screw 2	Coolant unit	Wrench 2	Coolant plug	Wrench 3	DirectJet plug	Wrench 4
JPDJ2XR/L**07	SLLV-2	SL-PI-2	SR10400611	HW2.0/5RED	-	-	-	-	-	-	-
JSDJ2XR1012H07-CHP	-	-	-	-	SR34-514	-	T-7F	SR5/16UNFTL360	P-4	SSHM4-6-TB	P-2
JSDJ2XR**07-CHP	-	-	-	-	SR34-514	S-CU-CHP	T-7F	SR5/16UNFTL360	P-4	SSHM4-6-TB	P-2
JSDJ2XR/L1212F07-CHP	-	-	-	-	SR34-514	S-CU-CHP	T-7F	SR5/16UNFTL360	P-4	-	-
JSDJXR**F15	-	-	-	-	SR34-514	-	T-7F	-	-	-	-

Reference pages : JPDJ2XR/L, JSDJ2XR-CHP: : Inserts → **B126** -
Standard cutting conditions → **G094**

JSDJXR-F

Screw-on stepped-head toolholder with 93° approach angle, for DX*U inserts

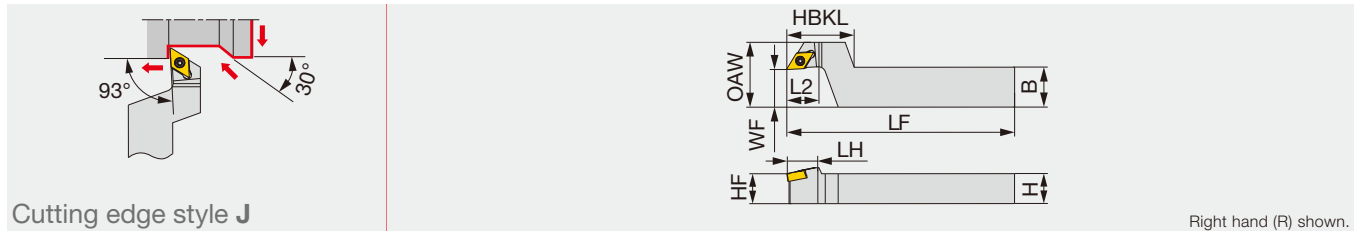

Right hand (R) shown.

Designation	H	B	LF	L2	HBKL	LH	HF	WF	OAW	RE**	Insert	Torque*
JSDJXR1016X07-F15	10	16	120	12	27	14	10	15	26	0.2	DX*U0703**L...	0.9
JSDJXR1216F07-F15	12	16	85	12	27	14	12	15	26	0.2	DX*U0703**L...	0.9
JSDJXR1216X07-F15	12	16	120	12	27	14	12	15	26	0.2	DX*U0703**L...	0.9
JSDJXR1620X07-F15	16	20	120	12	27	14	16	15	26	0.2	DX*U0703**L...	0.9

Torque*: Recommended clamping torque (N-m) RE**: Standard corner radius
Use right-hand toolholders (R) with left-hand inserts (L).

SPARE PARTS



Designation	Clamping screw	Wrench
JSDJXR**F15	SR34-514	T-7F

INSERT SELECTION

for Swiss lathes

P

Application areas	Finish cutting	Medium to finish cutting
Grade	SH725	SH725
Breaker Shape	JSS	JS
Cutting conditions	G094	

M

Application areas	Finish cutting	Medium to finish cutting
Grade	SH725	SH725
Breaker Shape	JSS	JS
Cutting conditions	G094	

for Small CNC lathes

P

Application areas	Finish cutting	Medium cutting
Grade	AH725	AH725
Breaker Shape	SS	TS
Cutting conditions	G094	

M

Application areas	Finish cutting	Medium cutting
Grade	AH8015	AH8015
Breaker Shape	SS	TS
Cutting conditions	G094	

N

Application areas	Medium to finish cutting	
Grade	KS05F	KS05F
Breaker Shape	SS	TS
Cutting conditions	B022	

Reference pages : JSDJXR-F: Inserts → **B126** -, Standard cutting conditions → **G094**



MODUM^{INI}TURN

QC12-JSVJ2BR

Screw-on modular head with 93° approach angle, for positive 35° rhombic inserts

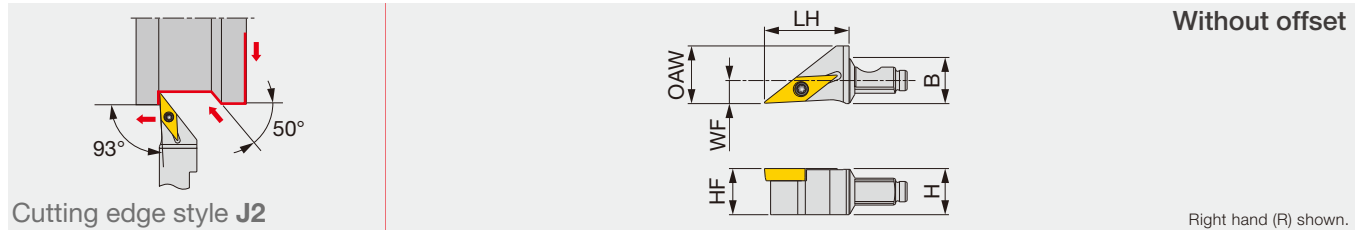

Designation	H	B	LH	HF	WF	OAW	RE**	Insert	Torque*
QC12-JSVJ2BR11	12	12	22	12	6	15	0.2	VB**1103...	1.2

Torque*: Recommended clamping torque (N-m) RE**: Standard corner radius



QC12-JSVJ2BR-CHP

Screw-on modular head with 93° approach angle, for positive 35° rhombic inserts, with high pressure coolant capability

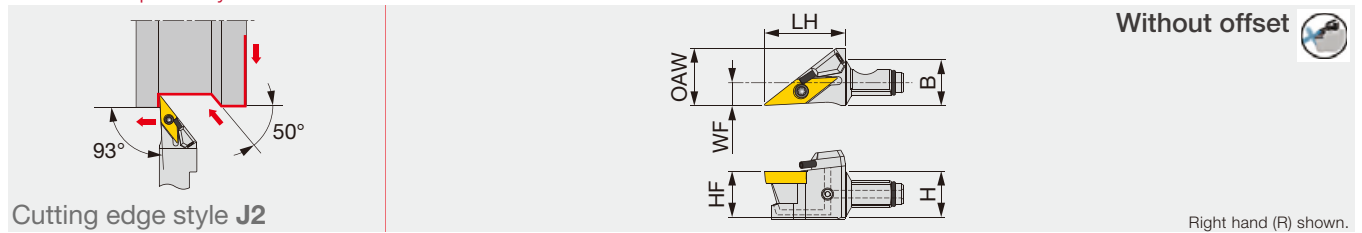

Designation	H	B	LH	HF	WF	OAW	RE**	Insert	Torque*
QC12-JSVJ2BR11-CHP	12	12	21	12	6	15	0.2	VB**1103...	1.2

Torque*: Recommended clamping torque (N-m)
RE**: Standard corner radius



JSVJ2BR/L

Screw-on toolholder with 93° approach angle, for positive 35° rhombic inserts

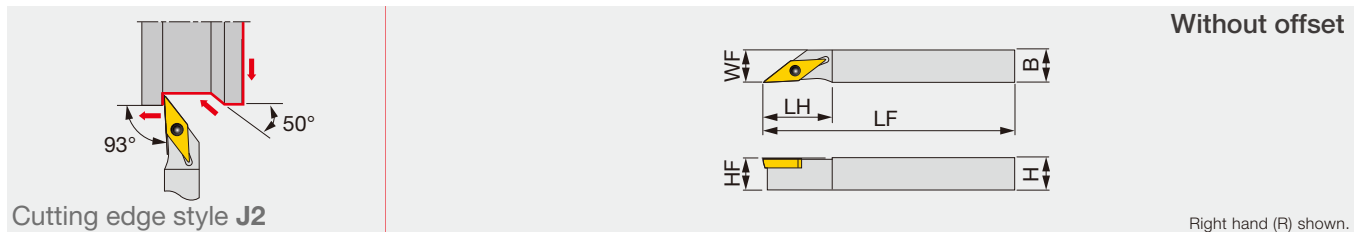

Designation	H	B	LF	LH	HF	WF	RE**	Insert	Torque*
JSVJ2BR/L1010X11	10	10	120	21	10	10	0.2	VB**1103...	1.2
JSVJ2BR/L1212F11	12	12	85	21	12	12	0.2	VB**1103...	1.2
JSVJ2BR/L1212X11	12	12	120	21	12	12	0.2	VB**1103...	1.2
JSVJ2BR/L1616X11	16	16	120	21	16	16	0.2	VB**1103...	1.2

Torque*: Recommended clamping torque (N-m)
RE**: Standard corner radius

SPARE PARTS

Designation	Clamping screw	Wrench 1	O-ring	Coolant nozzle	Screw	Wrench 2
QC12-JSVJ2BR11, JSVJ2BR/L...	CSTB-2.5	T-8F	-	-	-	-
QC12-JSVJ2BR11-CHP	CSTB-2.5	T-8F	ORSS-0454.5X1.0NBR70	NZ-1.10-7-CHP	SSHM4-4-TB	P-2

Reference pages : QC12-JSVJ2BR, QC12-JSVJ2BR-CHP, JSVJ2BR/L: Inserts → B150 -, CBN → B207 -,
Shank, Accessory → G095, G096

Screw-on toolholder without offset, 93° approach angle for positive 35° rhombic inserts, high pressure coolant compatible

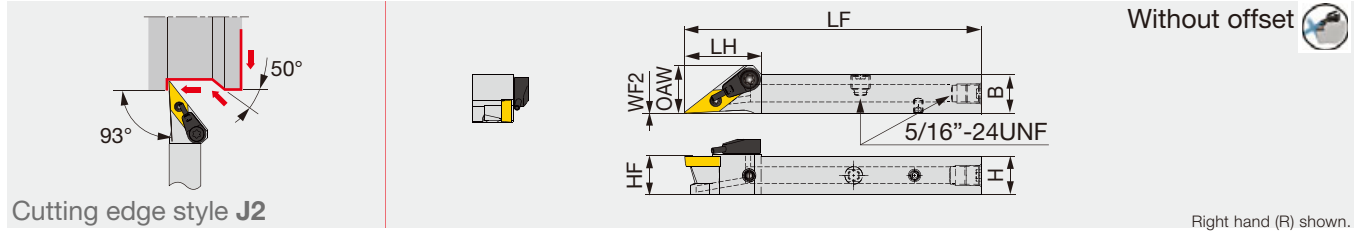

Cutting edge style J2

Designation	H	B	LF	LH	HF	WF2	OAW	RE	Insert	Torque*
JSVJ2BR1212X11-CHP	12	12	120	23.6	12	0	14.7	0.2	VB**1103	1.2
JSVJ2BR1616X11-CHP	16	16	120	23.6	16	0	16	0.2	VB**1103	1.2

Right hand (R) shown.

Tube connection

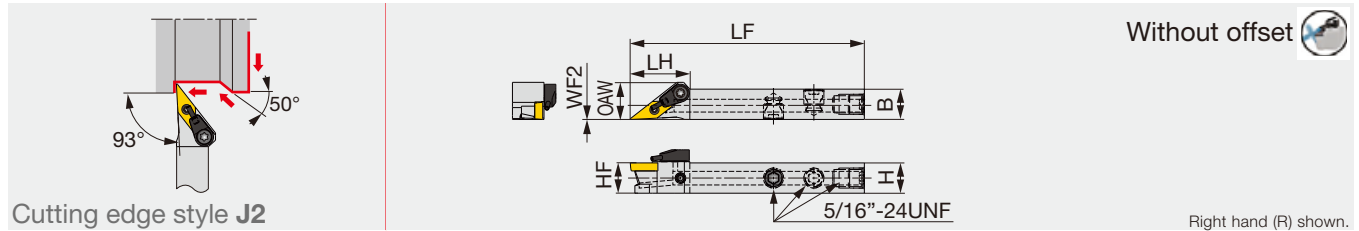

Cutting edge style J2

Designation	H	B	LF	LH	HF	WF2	OAW	RE**	Insert	Torque*
JSVJ2BR/L1212F11-CHP	12	12	85	23.6	12	0	14.7	0.2	VB**1103...	1.2

Right hand (R) shown.

Torque*: Recommended clamping torque (N-m)
RE**: Standard corner radius

SPARE PARTS

Designation	Clamping screw	Coolant unit	Wrench	Coolant plug	Wrench	DirectJet plug	Wrench
JSVJ2B**X11-CHP	CSTB-2.5	S-CU-CHP	T-8F	SR5/16UNFTL360	P-4	SSHM4-6-TB	P-2
JSVJ2B**F11-CHP	CSTB-2.5	S-CU-CHP	T-8F	SR5/16UNFTL360	P-4	-	-

INSERT SELECTION

P Application areas: Precision finishing, Finish cutting, Medium to finish cutting, Medium to finish cutting. Grade: SH725, SH725, SH725, SH725. Breaker Shape: JP, JS, JS, J10. Cutting conditions: G094.

M Application areas: Precision finishing, Finish cutting, Medium to finish cutting, Medium to finish cutting. Grade: SH725, SH725, SH725, SH725. Breaker Shape: JP, JS, JS, J10. Cutting conditions: G094.

K Application areas: Medium to finish cutting. Grade: T515. Breaker Shape: CM. Cutting conditions: B020.

S Application areas: Finish cutting, Medium to finish cutting. Grade: SH725, SH725. Breaker Shape: JS, JS. Cutting conditions: G094.

H Application areas: Precision finishing, Finish cutting. Grade: BXA10, BXA10. Breaker Shape: HP, CBN. Cutting conditions: B026.

Reference pages : JSVJ2BR/L-CHP: Inserts → B150 -, CBN → B207 -



Screw-on toolholder with 93° approach angle, for positive 35° rhombic inserts

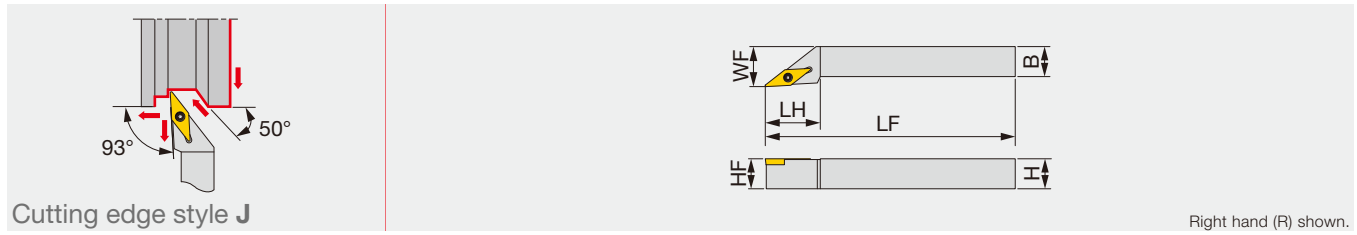

Cutting edge style J

Right hand (R) shown.

Designation	H	B	LF	LH	HF	WF	RE**	Insert	Torque*
JSVJBR/L1010H11	10	10	100	20	10	12	0.4	VB**1103...	1.2
JSVJBR/L1212H11	12	12	100	22	12	16	0.4	VB**1103...	1.2
JSVJBR/L1616H11	16	16	100	22	16	20	0.4	VB**1103...	1.2

Torque*: Recommended clamping torque (N-m) RE**: Standard corner radius



JSVJBR-F

Screw-on stepped-head toolholder with 93° approach angle, for positive 35° rhombic inserts

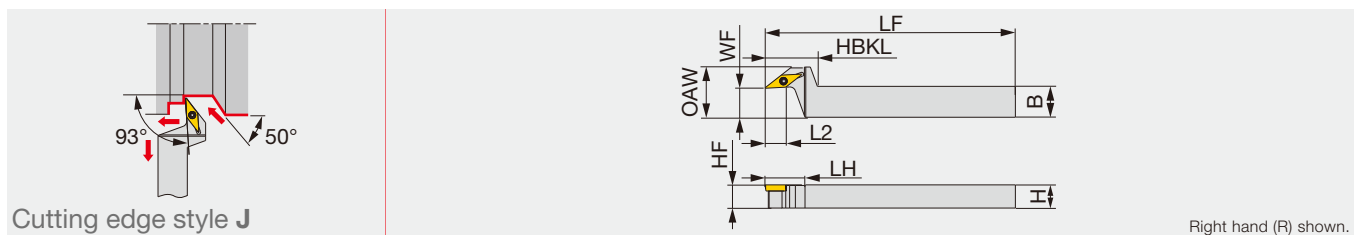

Cutting edge style J

Right hand (R) shown.

Designation	H	B	LF	L2	HBKL	LH	HF	WF	OAW	RE**	Insert	Torque*
JSVJBR1216F11-F15	12	16	85	12.6	27	21	12	15	26	0.2	VB**1103...	1.2
JSVJBR1216X11-F15	12	16	120	12.6	27	21	12	15	26	0.2	VB**1103...	1.2
JSVJBR1620X11-F15	16	20	120	12.6	27	21	16	15	26	0.2	VB**1103...	1.2

Torque*: Recommended clamping torque (N-m) RE**: Standard corner radius



SPARE PARTS

Designation	Clamping screw	Wrench 1	Wrench 2 (Optional)
JSVJBR/L..., JSVJBR**-F15	CSTB-2.5	T-8F	(T-8L)



INSERT SELECTION

P	Application areas	Precision finishing	Finish cutting	Medium to Finish cutting	Medium to finish cutting	M	Application areas	Precision finishing	Finish cutting	Medium to finish cutting	Medium to finish cutting	
	Grade	SH725	SH725	AH725	SH725		Grade	SH725	SH725	AH725	SH725	
	Breaker Shape	JP	JS	JS	J10		Breaker Shape	JP	JS	JS	J10	
	Images						Images					
	Cutting conditions	G053					Cutting conditions	G053				
K	Application areas	Medium to finish cutting					S	Application areas	Finish cutting	Medium to finish cutting		
	Grade	T515						Grade	SH725	AH725		
	Breaker Shape	CM						Breaker Shape	JS	JS		
	Images							Images				
	Cutting conditions	B022						Cutting conditions	G053			
H	Application areas	Precision finishing	Finish cutting									
	Grade	BXA10	BXA10									
	Breaker Shape	HP	CBN									
	Images											
	Cutting conditions	B028										

Reference pages : JSVJBR/L, JSVJBR-F: Inserts → B150 -, CBN → B207 -

Screw-on toolholder with 93° approach angle, for VXGU inserts

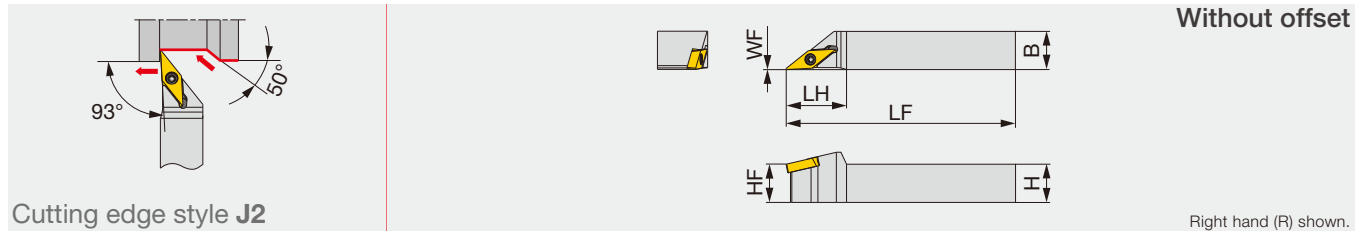

Designation	H	B	LF	LH	HF	WF	RE**	Insert	Torque*
JSVJ2XR/L1010X09	10	10	120	17	10	0	0.2	VXGU09T2**/L...	0.9
JSVJ2XR/L1212F09	12	12	85	19	12	0	0.2	VXGU09T2**/L...	0.9
JSVJ2XR/L1212X09	12	12	120	19	12	0	0.2	VXGU09T2**/L...	0.9
JSVJ2XR/L1616X09	16	16	120	19	16	0	0.2	VXGU09T2**/L...	0.9
JSVJ2XR/L2020H09	20	20	100	19	20	0	0.2	VXGU09T2**/L...	0.9

Torque*: Recommended clamping torque (N-m) RE**: Standard corner radius
 Use right-hand toolholders (R) with left-hand inserts (L).
 Use left-hand toolholders (L) with right-hand inserts (R).

QC12-JSVJ2XR

Screw-on modular head with 93° approach angle, for VXGU inserts

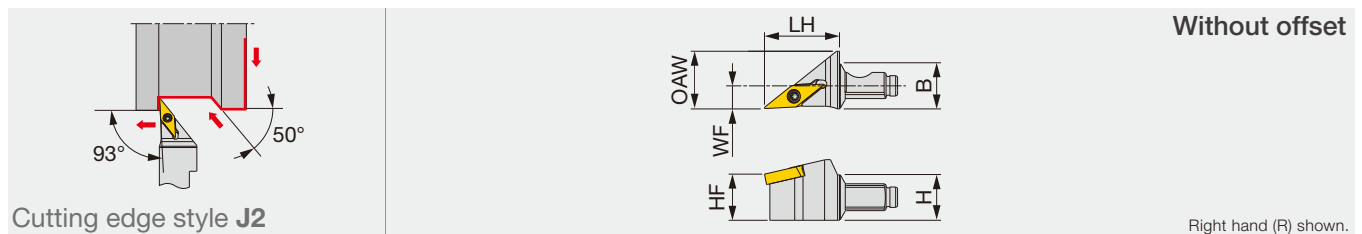

Designation	H	B	LH	HF	WF	OAW	RE**	Insert	Torque*
QC12-JSVJ2XR09	12	12	19.5	12	6	15	0.2	VXGU09T2**L...	0.9

Torque*: Recommended clamping torque (N-m)
 RE**: Standard corner radius
 Use right-hand toolholders (R) with left-hand inserts (L).

SPARE PARTS

Designation	Clamping screw	Wrench
JSVJ2XR/L..., QC12-JSVJ2XR09	SR34-508	T-7F

INSERT SELECTION

Application areas	Finish cutting	Medium to finish cutting
	Grade	SH725
Breaker Shape	JRP	JS
Cutting conditions	G094	

Application areas	Finish cutting	Medium to finish cutting
	Grade	SH725
Breaker Shape	JRP	JS
Cutting conditions	G094	

Reference pages : JSVJ2XR/L, QC12-JSVJ2XR: Inserts → **B155**, Shank, Accessory → **G095**, **G096**
 Standard cutting conditions → **G094**

Grade
Insert
Ext. Toolholder
Int. Toolholder
Threading
Grooving
Miniature tool
Milling cutter
Endmill
Drilling tool
Tooling System
User's Guide
Index

A
B
C
D
E
F
G
H
I
J
K
L
M

MINIFORCE

QC12-JSVJ2XR-CHP

Screw-on modular head with 93° approach angle, for VXGU inserts, with high pressure coolant capability

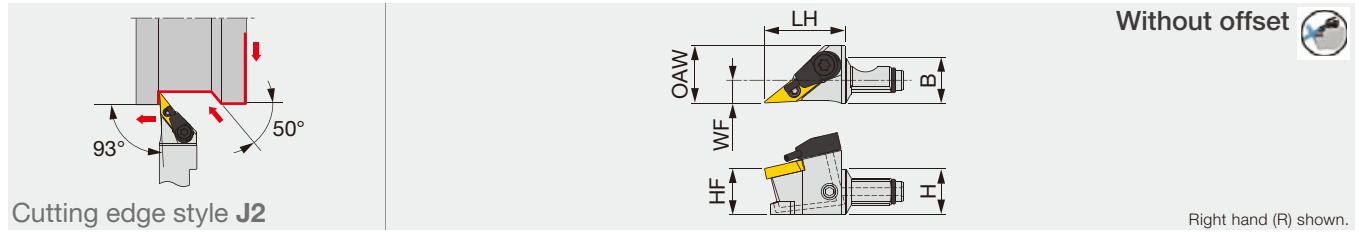

Designation	H	B	LH	HF	WF	OAW	RE**	Insert	Torque*
QC12-JSVJ2XR09-CHP	12	12	21	12	6	15	0.2	VXGU09T2**L...	0.9

Torque*: Recommended clamping torque (N-m)
 RE**: Standard corner radius
 Use right-hand toolholders (R) with left-hand inserts (L).

JPVJ2XR/L

Lever-lock toolholder with 93° approach angle, for VXGU inserts

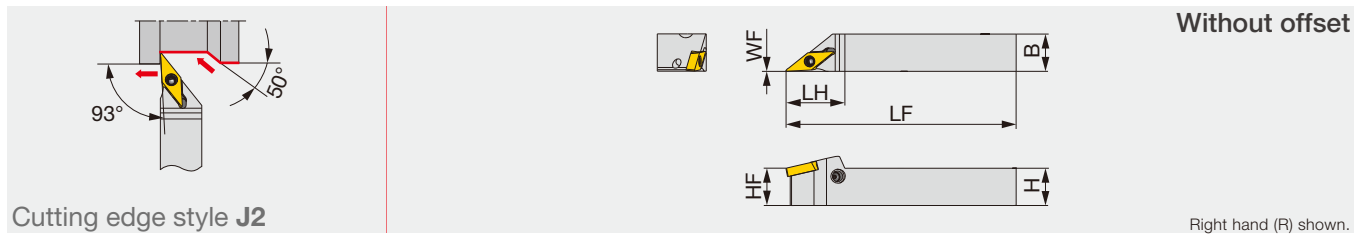

Designation	H	B	LF	LH	HF	WF	RE**	Insert	Torque*
JPVJ2XR/L1010X09	10	10	120	19	10	0	0.2	VXGU09T2**L/R...	0.9
JPVJ2XR/L1212F09	12	12	85	19	12	0	0.2	VXGU09T2**L/R...	0.9
JPVJ2XR/L1212X09	12	12	120	19	12	0	0.2	VXGU09T2**L/R...	0.9
JPVJ2XR/L1616X09	16	16	120	19	16	0	0.2	VXGU09T2**L/R...	0.9

Torque*: Recommended clamping torque (N-m) RE**: Standard corner radius
 Use right-hand toolholders (R) with left-hand inserts (L).
 Use left-hand toolholders (L) with right-hand inserts (R).

SPARE PARTS

Designation	Clamping screw	Coolant unit	Wrench	O-ring	Lever	Pin	Clamping screw	Wrench
QC12-JSVJ2XR09-CHP	SR34-508	S-CU-CHP	T-7F	ORSS-0454.5X1.0NBR70	-	-	-	-
JPVJ2XR/L...	-	-	-	-	SLLV-1	SL-PI-2	SR10400611	HW2.0/5RED

INSERT SELECTION

Application areas	Finish cutting	Medium to finish cutting
	Grade	SH725
Breaker Shape	JRP	JS
Images		
Cutting conditions	G094	

Application areas	Finish cutting	Medium to finish cutting
	Grade	SH725
Breaker Shape	JRP	JS
Images		
Cutting conditions	G094	

Reference pages : QC12-JSVJ2XR-CHP, JPVJ2XR/L: Inserts → **B155**
 Shank, Accessory → **G095, G096**, Standard cutting conditions → **G094**

JSVJ2XR/L-CHP

Direct connection

Screw-on toolholder without offset, 93° approach angle, for VXGU inserts, high pressure coolant compatible

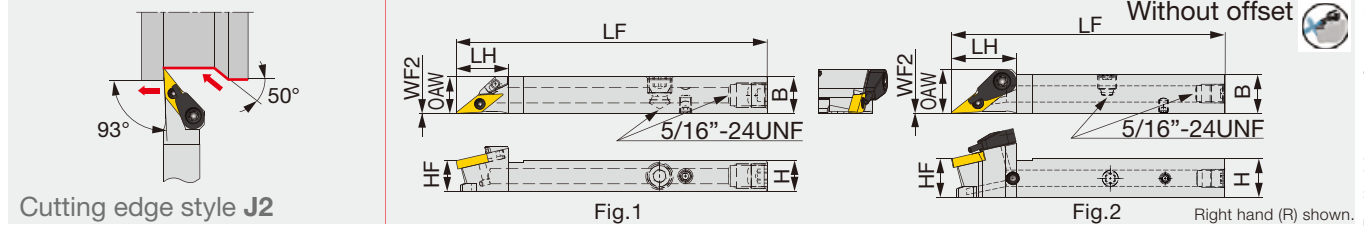

Designation	H	B	LF	LH	HF	WF2	OAW	RE**	Insert	Torque*	Fig.
JSVJ2XR1012H09-CHP	10	12	100	17	10	0	12	0.2	VXGU09T2**L	0.9	1
JSVJ2XR1212X09-CHP	12	12	120	19.5	12	0	13.4	0.2	VXGU09T2**L	0.9	2
JSVJ2XR1616X09-CHP	16	16	120	19.5	16	0	16	0.2	VXGU09T2**L	0.9	2

Tube connection

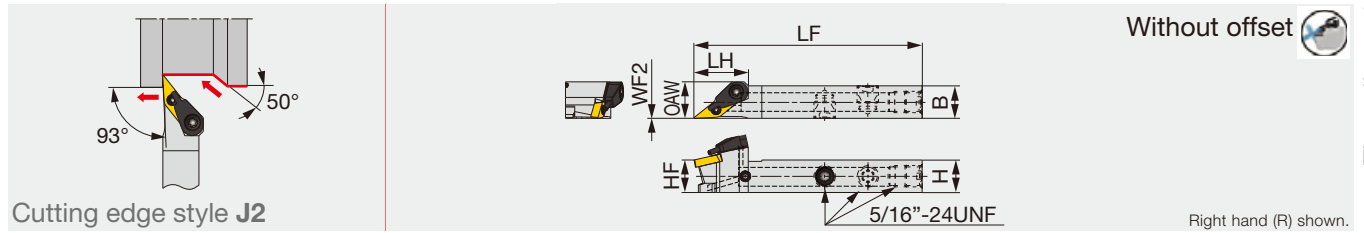

Designation	H	B	LF	LH	HF	WF2	OAW	RE**	Insert	Torque*
JSVJ2XR/L1212F09-CHP	12	12	85	20	12	0	13.5	0.2	VXGU09T2**L/R...	0.9

Torque*: Recommended clamping torque (N-m) RE**: Standard corner radius
Right-hand toolholders (R) are used with left-hand inserts (L). Left-hand toolholders (L) are used with right-hand inserts (R).

JSVJXR-F

Screw-on stepped-head toolholder with 93° approach angle, for VXGU inserts

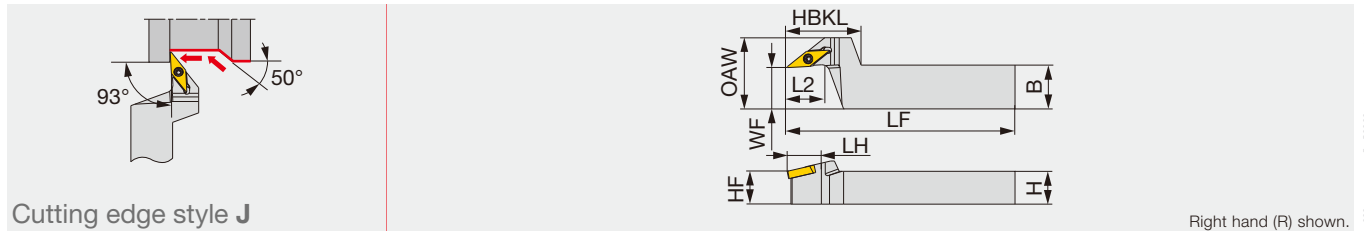

Designation	H	B	LF	L2	HBKL	LH	HF	WF	OAW	RE**	Insert	Torque*
JSVJXR1016X09-F15	10	16	120	12	27	19	10	15	26	0.2	VXGU09T2**L...	0.9
JSVJXR1216F09-F15	12	16	85	12	27	19	12	15	26	0.2	VXGU09T2**L...	0.9
JSVJXR1216X09-F15	12	16	120	12	27	19	12	15	26	0.2	VXGU09T2**L...	0.9
JSVJXR1620X09-F15	16	20	120	12	27	19	16	15	26	0.2	VXGU09T2**L...	0.9

Torque*: Recommended clamping torque (N-m) RE**: Standard corner radius
Use right-hand toolholders (R) with left-hand inserts (L).

SPARE PARTS

Designation	Clamping screw	Coolant unit	Wrench	Coolant plug	Wrench	DirectJet plug	Wrench
JSVJ2XR1012H09-CHP	SR34-508	-	T-7F	SR5/16UNFTL360	P-4	SSH4-6-TB	P-2
JSVJ2XR**X09-CHP	SR34-508	S-CU-CHP	T-7F	SR5/16UNFTL360	P-4	SSH4-6-TB	P-2
JSVJ2XR/L1212F09-CHP	SR34-508	S-CU-CHP	T-7F	SR5/16UNFTL360	P-4	-	-
JSVJXR**-F15	SR34-508	-	T-7F	-	-	-	-

Reference pages : JSVJ2XR/L-CHP, JSVJXR-F: Inserts → **B155**, Standard cutting conditions → **G094**

PDJNR

Lever-lock toolholder with 93° approach angle, for negative 55° rhombic inserts

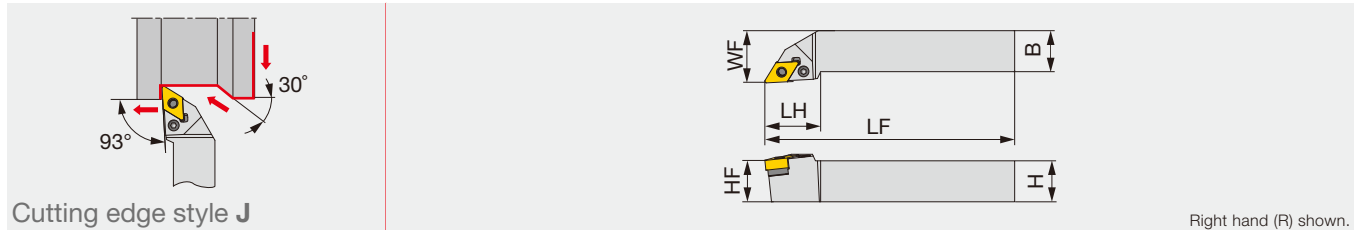

Designation	H	B	LF	LH	HF	WF	RE**	Insert	Torque*
PDJNR2020H15	20	20	100	32	20	25	0.8	DN**1504...	3

Torque*: Recommended clamping torque (N·m)
RE**: Standard corner radius

SPARE PARTS

Designation	Shim	Clamping screw	Lever	Spring pin	Wrench
PDJNR2020H15	LSD42	LCS4	LCL4	LSP4	P-3

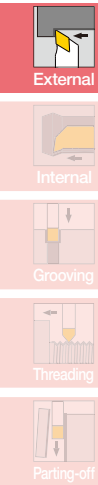

INSERT SELECTION

P	Application areas	Precision finishing	Finish cutting	Medium cutting	Medium to heavy cutting
	Grade	NS9530	GT9530	T9215	T9215
	Breaker Shape				
	Cutting conditions	B004			
M	Application areas	Finish cutting	Medium cutting	Medium to heavy cutting	
	Grade	T6215	AH6225	AH6225	
	Breaker Shape				
	Cutting conditions	B006			
K	Application areas	Finish cutting	Medium cutting	Medium to heavy cutting	
	Grade	T515	T515	T515	
	Breaker Shape				
	Cutting conditions	B008			
N	Application areas	Precision finishing	Finish cutting	Medium cutting	
	Grade	DX110	DX140	TH10	KS05F
	Breaker Shape				
	Cutting conditions	B010			
S	Application areas	Precision finishing	Finish cutting	Medium cutting	
	Grade	BX950	AH8005	AH8005	
	Breaker Shape				
	Cutting conditions	B012			
H	Application areas	Precision finishing	Finish cutting		
	Grade	BXA10	BXA10		
	Breaker Shape				
	Cutting conditions	B014			

Reference pages : PDJNR: Inserts → **B066 -**, CBN → **B172 -**, PCD → **B211**

Back-clamp toolholder with 93° approach angle, for negative 35° rhombic inserts

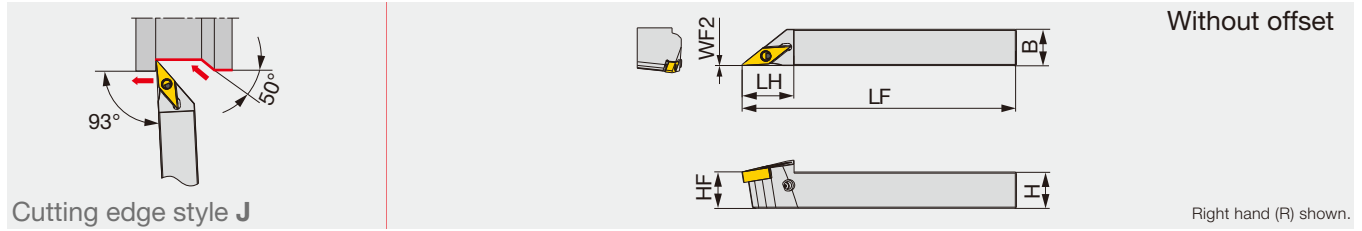

Designation	H	B	LF	LH	HF	WF2	RE**	Insert	Torque*
JPVJ2NR/L1212X1204	12	12	120	23	12	0	0.2	VN**1204...	0.9
JPVJ2NR/L1616X1204	16	16	120	23	16	0	0.2	VN**1204...	0.9

Torque*: Recommended clamping torque (N-m)

RE**: The holder measurements are true with this insert radius

SPARE PARTS

Designation	Lever	Pin	Clamping screw	Wrench
JPVJ2NR/L**1204	SLLV-4	SL-PI-2	SR10400611	HW2.0/5RED

INSERT SELECTION

Application	Finishing	Medium cutting
	Grade	T9215
Chipbreaker shape		
Cutting conditions	B004	

Application	Finishing	Medium cutting
	Grade	AH6225
Chipbreaker shape		
Cutting conditions	B006	



Screw-on toolholder with 62.5° approach angle, for positive 55° rhombic inserts

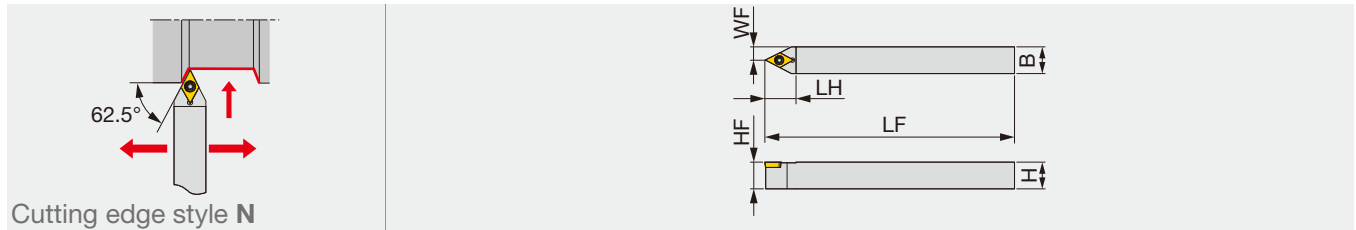

Cutting edge style N

Designation	H	B	LF	LH	HF	WF	RE**	Insert	Torque*
JSDNCN1010X07	10	10	120	15	10	5	0.2	DC**0702...	1.2
JSDNCN1010X11	10	10	120	21	10	5	0.2	DC**11T3...	1.2
JSDNCN1212F07	12	12	85	15	12	6	0.2	DC**0702...	1.2
JSDNCN1212X07	12	12	120	15	12	6	0.2	DC**0702...	1.2
JSDNCN1212F11	12	12	85	21	12	6	0.2	DC**11T3...	1.2
JSDNCN1212X11	12	12	120	21	12	6	0.2	DC**11T3...	1.2
JSDNCN1616X11	16	16	120	21	16	8	0.2	DC**11T3...	1.2

Torque*: Recommended clamping torque (N-m)

RE**: Standard corner radius



External

JSDN3CR

Screw-on toolholder with 62.5° approach angle (N3-style), for positive 55° rhombic inserts

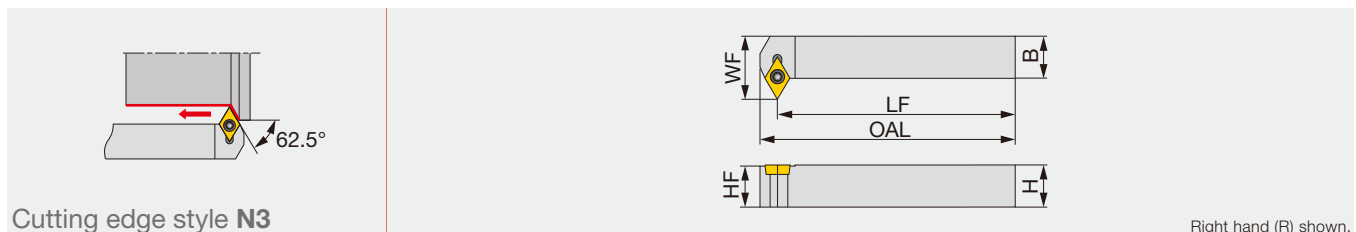

Cutting edge style N3

Right hand (R) shown.

Designation	H	B	OAL	LF	HF	WF	RE**	Insert	Torque*
JSDN3CR1212H07	12	12	105	100	12	18	0.4	DC**0702...	1.2
JSDN3CR1616H11	16	16	107	100	16	25	0.8	DC**11T3...	1.2

Torque*: Recommended clamping torque (N-m)

RE**: Standard corner radius



Internal



Grooving



Threading



Parting-off

SPARE PARTS

Designation	Clamping screw	Wrench 1	Wrench 2 (Optional)
JSDNCN**07, JSDN3CR1212H07	CSTB-2.5	T-8F	(T-8L)
JSDNCN**11, JSDN3CR1616H11	CSTB-4SD	T-8F	(T-8L)

INSERT SELECTION

P	Application areas	Precision finishing	Finish cutting	Medium to finish cutting	M	Application areas	Precision finishing	Finish cutting	Medium to finish cutting		
	Grade	SH725	SH725	SH725		SH725	Grade	SH725	SH725	SH725	
	Breaker Shape	01	JP	JS	JS	Breaker Shape	01	JP	JS	JS	
	Cutting conditions	G094					Cutting conditions	G094			
P	Application areas	Medium to finish cutting				M	Application areas	Medium to finish cutting			
	Grade	SH725					Grade	SH725			
	Breaker Shape	J10					Breaker Shape	J10			
	Cutting conditions	G094					Cutting conditions	G094			
K	Application areas	Medium to finish cutting				N	Application areas	Precision finishing	Finish cutting	Medium cutting	
	Grade	T515					Grade	DX110	DX140	KS05F	
	Breaker Shape	CM					Breaker Shape	DIA	AL		
	Cutting conditions	B020					Cutting conditions	B022			
S	Application areas	Finish cutting	Medium to finish cutting				H	Application areas	Precision finishing	Finish cutting	
	Grade	SH725	SH725					Grade	BXA10	BXA10	
	Breaker Shape	JS	JS					Breaker Shape	HP	CBN	
	Cutting conditions	G094					Cutting conditions	B026			

Reference pages : JSDNCN, JSDN3CR/L: Inserts → B121 -, CBN → B193 -, PCD → B214

JSVNBN

Screw-on toolholder with 72.5° approach angle, for positive 35° rhombic inserts

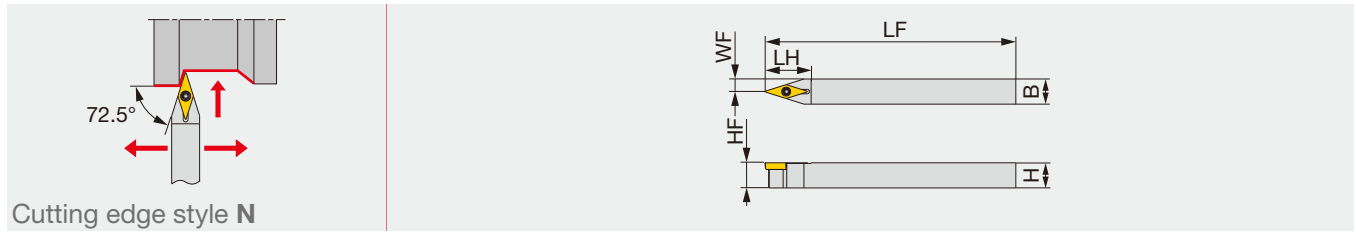

Designation	H	B	LF	LH	HF	WF	RE**	Insert	Torque*
JSVNBN1010X11	10	10	120	22	10	5	0.2	VB**1103...	1.2
JSVNBN1212F11	12	12	85	22	12	6	0.2	VB**1103...	1.2
JSVNBN1212X11	12	12	120	22	12	6	0.2	VB**1103...	1.2
JSVNBN1616X11	16	16	120	22	16	8	0.2	VB**1103...	1.2

Torque*: Recommended clamping torque (N·m)
RE**: Standard corner radius

SPARE PARTS

Designation	Clamping screw	Wrench 1	Wrench 2 (Optional)
JSVNBN...	CSTB-2.5	T-8F	(T-8L)

INSERT SELECTION

P	Application areas	Precision finishing	Finish cutting	Medium to finish cutting	Medium to finish cutting
	Grade	SH725	SH725	SH725	SH725
	Breaker Shape	JP	JS	JS	J10
	Images				
Cutting conditions		G094			
M	Application areas	Precision finishing	Finish cutting	Medium to finish cutting	Medium to finish cutting
	Grade	SH725	SH725	SH725	SH725
	Breaker Shape	JP	JS	JS	J10
	Images				
Cutting conditions		G094			
K	Application areas	Medium to finish cutting			
	Grade	T515			
	Breaker Shape	CM			
	Images				
Cutting conditions		B020			
S	Application areas	Finish cutting	Medium to finish cutting		
	Grade	SH725	SH725		
	Breaker Shape	JS	JS		
	Images				
Cutting conditions		G094			
H	Application areas	Precision finishing	Finish cutting		
	Grade	BXA10	BXA10		
	Breaker Shape	HP	CBN		
	Images				
Cutting conditions		B026			

Reference pages : JSVNBN: Inserts → B150 -, CBN → B207 -



Screw-on modular head with 62.5° approach angle, for DX*U inserts, with high pressure coolant capability

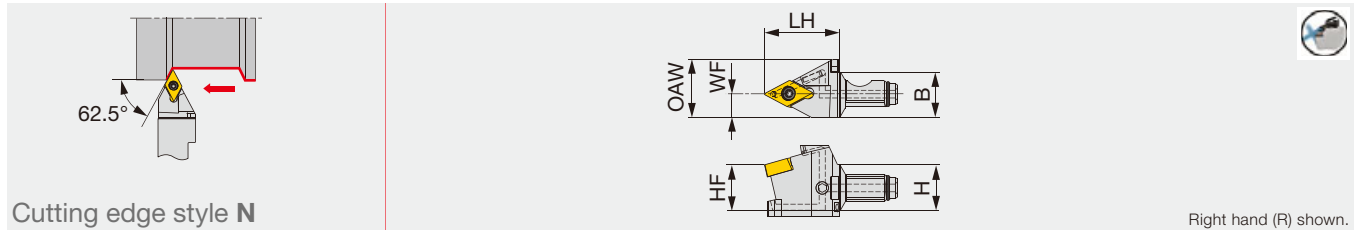

Designation	H	B	LH	HF	WF	OAW	RE**	Insert	Torque*
QC12-JSDNXR07-CHP	12	12	19.5	12	6	15	0.2	DX*U0703**L...	0.9

Torque*: Recommended clamping torque (N-m)
 RE**: Standard corner radius
 Use right-hand toolholders (R) with left-hand inserts (L).

- External
- Internal
- Grooving
- Threading
- Parting-off

SPARE PARTS

Designation	Clamping screw	Wrench	O-ring
QC12-JSDNXR07-CHP	SR34-508	T-7F	ORSS-0454.5X1.0NBR70

- L
- J
- N
- P
- A
- G
- D
- F
- Special

INSERT SELECTION

for Swiss lathes

P	Application areas	Finish cutting	Medium to finish cutting	M	Application areas	Finish cutting	Medium to finish cutting
	Grade	SH725	SH725		Grade	SH725	SH725
Breaker Shape	JSS	JS	Breaker Shape	JSS	JS		
Cutting conditions		G094		Cutting conditions		G094	

for Small CNC lathes

P	Application areas	Finish cutting	Medium cutting	M	Application areas	Finish cutting	Medium cutting	N	Application areas	Medium to finish cutting	
	Grade	AH725	AH725		Grade	AH8015	AH8015		Grade	KS05F	KS05F
Breaker Shape	SS	TS	Breaker Shape	SS	TS	Breaker Shape	SS	TS			
Cutting conditions		G094		Cutting conditions		G094		Cutting conditions		B022	

Reference pages : JSVJ2XR/L-CHP: Inserts → **B126 -**, Shank, Accessory → **G095, G096**
 Standard cutting conditions → **G094**

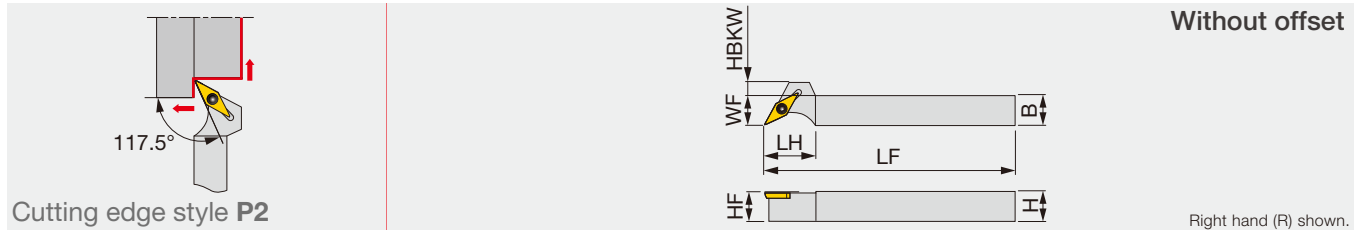

Cutting edge style **P2**

Designation	H	B	LF	LH	HF	WF	HBKW	RE**	Insert	Torque*
JSVP2PR/L1010K08	10	10	125	16	10	10	4	0.2	VP**0802...	0.6
JSVP2PR/L1010K11	10	10	125	20	10	10	8	0.2	VP**1103...	1.2
JSVP2PR/L1212K08	12	12	125	16	12	12	2	0.2	VP**0802...	0.6
JSVP2PR/L1212K11	12	12	125	20	12	12	6	0.2	VP**1103...	1.2
JSVP2PR/L1616K08	16	16	125	16	16	16	2	0.2	VP**0802...	0.6
JSVP2PR/L1616K11	16	16	125	20	16	16	6	0.2	VP**1103...	1.2

Torque*: Recommended clamping torque (N-m)
RE**: Standard corner radius

SPARE PARTS

Designation	Clamping screw	Wrench 1	Wrench 2 (Optional)
JSVP2PR/L**08	CSTB-2L	T-6F	(T-6L)
JSVP2PR/L**11	CSTB-2.5	T-8F	(T-8L)

INSERT SELECTION

P

Application areas	Finish cutting	Finish cutting
Grade	SH725	SH725
Breaker Shape	JRP	JSP
Breaker Shape		
Cutting conditions	G094	

M

Application areas	Finish cutting	Finish cutting
Grade	SH725	SH725
Breaker Shape	JRP	JSP
Breaker Shape		
Cutting conditions	G094	

S

Application areas	Finish cutting	Finish cutting
Grade	SH725	SH725
Breaker Shape	JRP	JSP
Breaker Shape		
Cutting conditions	G094	

Screw-on toolholder with 91° approach angle, for positive 60° triangular inserts

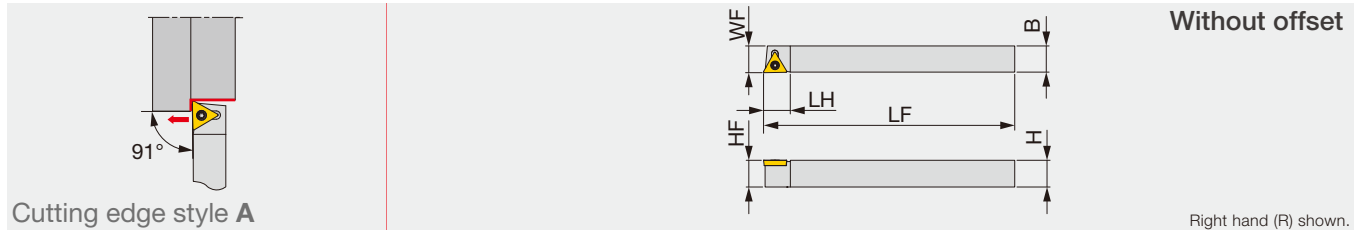

Designation	H	B	LF	LH	HF	WF	RE**	Insert	Torque*
JSTACR/L0808K08	8	8	125	10	8	8	0.2	TC**0802...	0.6
JSTACR/L1010K08	10	10	125	10	10	10	0.2	TC**0802...	0.6
JSTACR/L1212K11	12	12	125	12	12	12	0.4	TC**1102...	1.2
JSTACR/L1616H11	16	16	100	12	16	16	0.4	TC**1102...	1.2

Torque*: Recommended clamping torque (N-m) RE**: Standard corner radius

SPARE PARTS

Designation	Clamping screw	Wrench 1	Wrench 2 (Optional)
JSTACR/L**K08	CSTB-2L	T-6F	(T-6L)
JSTACR/L**11	CSTB-2.5	T-8F	(T-8L)

INSERT SELECTION

P	Application areas	Precision finishing	Finish cutting	Medium to finish cutting	M	Application areas	Precision finishing	Finish cutting	Medium to finish cutting		
	Grade	SH725	SH725	SH725		SH725	Grade	SH725	SH725	SH725	SH725
	Breaker Shape	01	JP	JS	JS	Breaker Shape	01	JP	JS	JS	
	Cutting conditions	G094					Cutting conditions	G094			
P	Application areas	Medium to finish cutting	M	Application areas	Medium to finish cutting						
	Grade	SH725		Grade	SH725						
Breaker Shape	J10	Breaker Shape	J10								
Cutting conditions	G094	Cutting conditions	G094								
K	Application areas	Medium to finish cutting	N	Application areas	Precision finishing	Medium cutting					
	Grade	T515		Grade	DX120	KS05F					
Breaker Shape	CM	Breaker Shape	DIA	with rake AL							
Cutting conditions	B020	Cutting conditions	B022								
H	Application areas	Finish cutting	H	Application areas	Finish cutting						
	Grade	BXA10		Grade	BXA10						
Breaker Shape	CBN	Breaker Shape	CBN								
Cutting conditions	B026	Cutting conditions	B026								

Reference pages : JSTACR/L: Inserts → B138 -, CBN → B198, PCD → B215

JTTACR/L

Back-clamp toolholder with 91° approach angle, for positive 60° triangular inserts

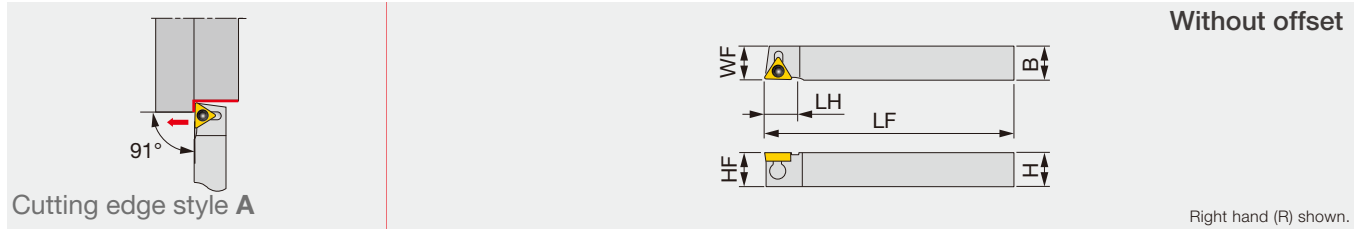

Designation	H	B	LF	LH	HF	WF	RE**	Insert	Torque*
JTTACL0810K08	8	10	125	10	8	10	0.2	TC**0802...	0.9
JTTACR/L1212M11	12	12	150	12	12	12	0.4	TC**1102...	0.9
JTTACR/L1616M11	16	16	150	12	16	16	0.4	TC**1102...	0.9

Torque*: Recommended clamping torque (N·m) RE**: Standard corner radius

SPARE PARTS

Designation	Clamp	Clamping screw	Wrench
JTTACL0810K08	JCP-1	JDS-3525	P-2F
JTTACR/L**M11	JCP-2	JDS-3525	P-2F

INSERT SELECTION

P	Application areas	Precision finishing	Finish cutting	Medium to finish cutting	M	Application areas	Precision finishing	Finish cutting	Medium to finish cutting		
	Grade	SH725	SH725	SH725		SH725	Grade	SH725	SH725	SH725	SH725
	Breaker Shape	01	JP	JS	JS		Breaker Shape	01	JP	JS	JS
	Cutting conditions	G094					Cutting conditions	G094			
P	Application areas	Medium to finish cutting	M	Application areas	Medium to finish cutting						
	Grade	SH725		Grade	SH725						
	Breaker Shape	J10		Breaker Shape	J10						
	Cutting conditions	G094		Cutting conditions	G094						
K	Application areas	Medium to finish cutting	N	Application areas	Precision finishing	Medium cutting					
	Grade	T515		Grade	DX120	KS05F					
	Breaker Shape	CM		Breaker Shape	DIA with rake AL						
	Cutting conditions	B020		Cutting conditions	B022						
H	Application areas	Finish cutting	M	Application areas	Precision finishing	Medium cutting					
	Grade	BXA10		Grade	DX120	KS05F					
	Breaker Shape	CBN		Breaker Shape	DIA with rake AL						
	Cutting conditions	B026		Cutting conditions	B022						

Reference pages : JTTACR/L: Inserts → B138 -, CBN → B198, PCD → B215



Screw-on toolholder with 91° approach angle, for positive 35° rhombic inserts

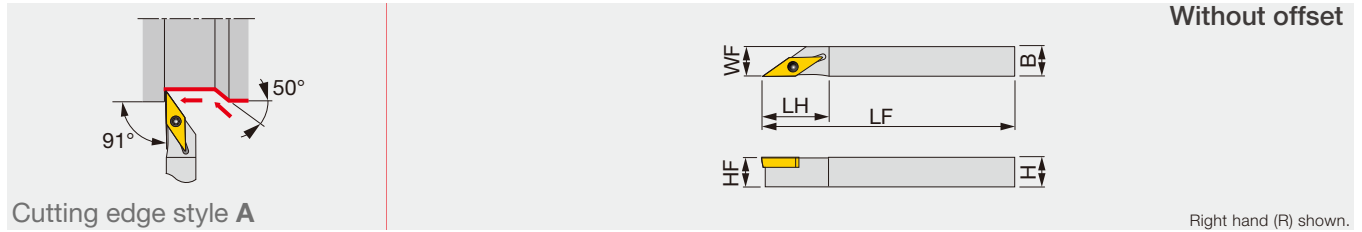

Designation	H	B	LF	LH	HF	WF	RE**	Insert	Torque*
JSVABR/L1010K11	10	10	125	21	10	10	0.2	VB**1103...	1.2
JSVABL1212K11	12	12	125	21	12	12	0.2	VB**1103...	1.2

Torque*: Recommended clamping torque (N-m)

RE**: Standard corner radius

SPARE PARTS

Designation	Clamping screw	Wrench 1	Wrench 2 (Optional)
JSVABR/L...	CSTB-2.5	T-8F	(T-8L)

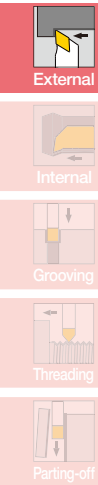

INSERT SELECTION

P	Application areas	Precision finishing	Finish cutting	Medium to finish cutting	Medium to finish cutting	M	Application areas	Precision finishing	Finish cutting	Medium to finish cutting	Medium to finish cutting
	Grade	SH725	SH725	SH725	SH725		Grade	SH725	SH725	SH725	SH725
	Breaker Shape	JP	JS	JS	J10		Breaker Shape	JP	JS	JS	J10
	Cutting conditions	G094					Cutting conditions	G094			
K	Application areas	Medium to finish cutting				S	Application areas	Finish cutting	Medium to finish cutting		
	Grade	T515					Grade	SH725	SH725		
	Breaker Shape	CM					Breaker Shape	JS	JS		
	Cutting conditions	B020					Cutting conditions	G094			
H	Application areas	Precision finishing	Finish cutting								
	Grade	BXA10	BXA10								
	Breaker Shape	HP	CBN								
	Cutting conditions	B026									

Reference pages : JSVABR/L: Inserts → B150 -, CBN → B207 -

JTTANR/L

Back-clamp toolholder with 91° approach angle, for negative 60° triangular inserts

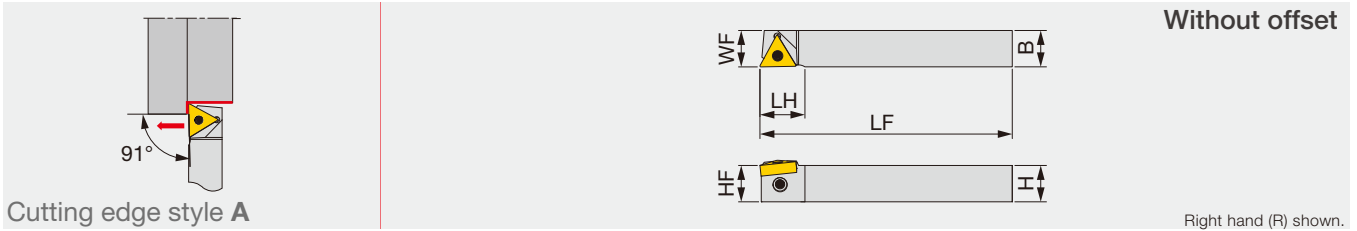

Designation	H	B	LF	LH	HF	WF	RE**	Insert	Torque*
JTTANR/L1216K16	12	16	125	19.8	12	16	0.4	TN**1604...	1.2
JTTANR/L1616K16	16	16	125	19.8	16	16	0.4	TN**1604...	1.2

Torque*: Recommended clamping torque (N-m)
RE**: Standard corner radius

SPARE PARTS

Designation	Clamp	Clamping screw	Wrench
JTTANR/L...	JCP-3N	JDS-5040	P-2.5F

INSERT SELECTION

P	Application areas	Precision finishing	Finish cutting		Medium cutting
	Grade	SH725	SH725	GT9530	T9215
	Breaker Shape	01	JRP	TSF	TM
Cutting conditions		G094			B004
M	Application areas	Precision finishing	Finish cutting	Medium cutting	
	Grade	SH725	SH725	AH6225	
	Breaker Shape	01	JRP	SM	
Cutting conditions		G094		B006	
P	Application areas	Medium to heavy cutting			
	Grade	T9215			
	Breaker Shape	TH			
Cutting conditions		B004			
K	Application areas	Finish cutting	Medium cutting	Medium to heavy cutting	
	Grade	T515	T515	T515	
	Breaker Shape	All-round	All-round	All-round	
Cutting conditions		B008			
N	Application areas	Precision finishing	Finish cutting	Medium cutting	
	Grade	DX110	DX140	TH10	KS05F
	Breaker Shape	DIA	with rake DIA	P	28
Cutting conditions		B010			
S	Application areas	Precision finishing	Finish cutting	Medium cutting	
	Grade	BX950	AH8005	AH8005	
	Breaker Shape	CBN	HRF	HRM	
Cutting conditions		B012			
H	Application areas	Precision finishing	Finish cutting		
	Grade	BXA10	BXA10		
	Breaker Shape	HP	HS		
Cutting conditions		B014			

Reference pages : JTTANR/L: Inserts → **B087** -, CBN → **B182** -, PCD → **B212**



Screw-on toolholder with 91° approach angle, for positive 80° rhombic inserts

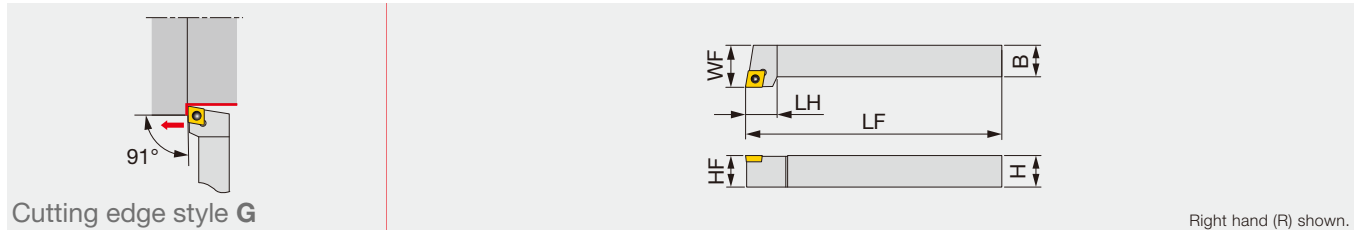

Right hand (R) shown.

Designation	H	B	LF	LH	HF	WF	RE**	Insert	Torque*
JSCGCR/L1212H06	12	12	100	12	12	16	0.4	CC**0602...	1.2
JSCGCR/L1616H09	16	16	100	16	16	20	0.8	CC**09T3...	1.2

Torque*: Recommended clamping torque (N-m)

RE**: Standard corner radius

SPARE PARTS

Designation	Clamping screw	Wrench 1	Wrench 2 (Optional)
JSCGCR/L1212H06	CSTB-2.5	T-8F	(T-8L)
JSCGCR/L1616H09	CSTB-4SD	T-8F	(T-8L)

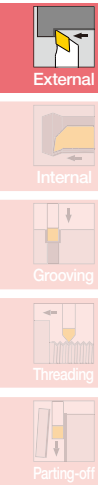

INSERT SELECTION

P	Application areas	Precision finishing	Finish cutting	Medium to finish cutting	M	Application areas	Precision finishing	Finish cutting	Medium to finish cutting	
	Grade	SH725	SH725	SH725		SH725	SH725	SH725	SH725	SH725
	Breaker Shape	01	JP	JS	JS	01	JP	JS	JS	
	Cutting conditions	G094					G094			
P	Application areas	Medium to finish cutting	M	Application areas	Medium to finish cutting					
	Grade	SH725		Grade	SH725					
	Breaker Shape	J10		Breaker Shape	J10					
	Cutting conditions	G094		Cutting conditions	G094					
K	Application areas	medium to finish cutting	N	Application areas	Precision finishing	Finish cutting	Medium cutting			
	Grade	T515		Grade	DX110	TH10	KS05F			
	Breaker Shape	CM		Breaker Shape	NS	W20	AL			
	Cutting conditions	B020		Cutting conditions	B022					
S	Application areas	Finish cutting	Medium to finish cutting	H	Application areas	Precision finishing	Finish cutting			
	Grade	SH725	SH725		Grade	BXA10	BXA20			
	Breaker Shape	JS	JS		Breaker Shape	CBN	CBN			
	Cutting conditions	G094			Cutting conditions	B026				

Reference pages : JSCGCR/L: Inserts → **B112 -**, CBN → **B191**, PCD → **B213**
Shank, Accessory → **G095**, **G096**

SSDC/PN

Screw-on toolholder with 45° approach angle, for positive square inserts

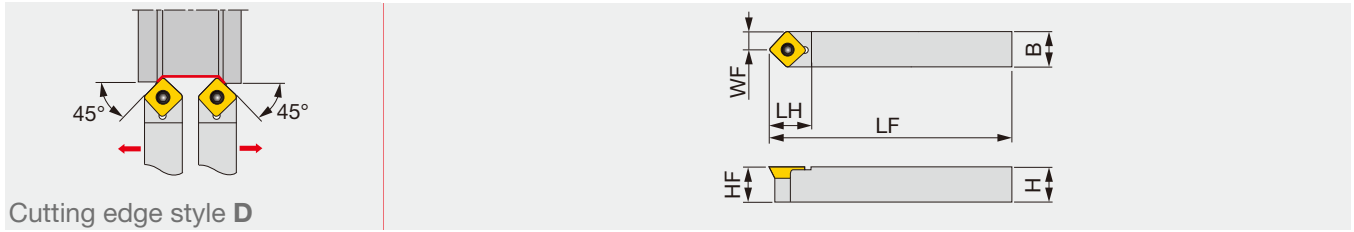

Designation	H	B	LF	LH	HF	WF	RE**	Insert
SSDCN1010K07	10	10	125	12	10	5	0.4	SC**0702...
SSDPN1010H	10	10	100	12	10	5	0.4	SP*P042...
SSDCN1212K09	12	12	125	15	12	6	0.8	SC**09T3...
SSDPN1212H	12	12	100	12	12	6	0.4	SP*P042...
SSDCN1616H09	16	16	100	15	16	8	0.8	SC**09T3...
SSDPN1616H	16	16	100	14	16	8	0.8	SP*M322...

RE**: Standard corner radius

SPARE PARTS

Designation	Clamping screw	Shim screw	Shim	Wrench 1	Wrench 2
SSDCN1010K07	CSTB-3	-	-	-	T-9F
SSDPN1010H	CSTA-NO3	-	-	-	T-9F
SSDCN1212K09	CSTB-4	-	-	-	T-15F
SSDPN1212H	CSTA-NO3	-	-	-	T-9F
SSDCN1616H09	CSTB-3.5L	DTS5-3.5	SSS32	P-3.5	T-15F
SSDPN1616H	CSTA-NO5	-	-	-	T-9F

INSERT SELECTION

P	Application areas	Medium to finish cutting	Medium cutting	M	Application areas	Medium cutting
	Grade	AH725	AH725		Grade	AH725
	Breaker Shape	PS	PM		Breaker Shape	PM
	Cutting conditions	B016			Cutting conditions	B018
K	Application areas	Medium to finish cutting				
	Grade	T515				
	Breaker Shape	CM				
	Cutting conditions	B020				

Reference pages : SSDC/PN: Inserts → **B134** -



Screw-on toolholder for facing with 91° approach angle, for positive 55° rhombic inserts

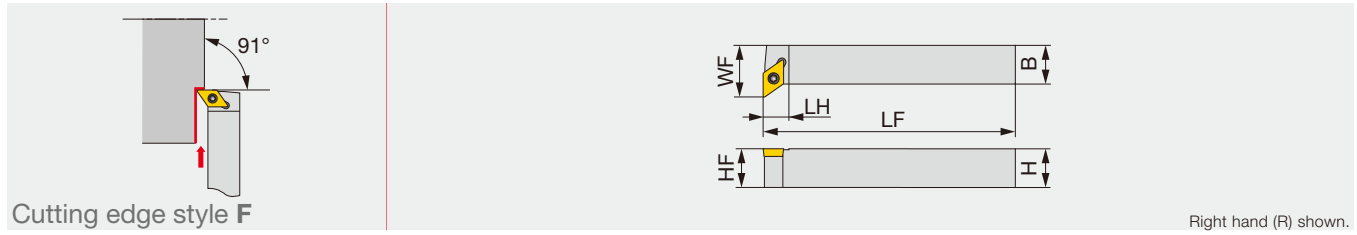

Right hand (R) shown.

Designation	H	B	LF	LH	HF	WF	RE**	Insert	Torque*
JSDFCR/L1212H07	12	12	100	8	12	16	0.4	DC**0702...	1.2
JSDFCR/L1616H11	16	16	100	10.5	16	22	0.8	DC**11T3...	1.2

Torque*: Recommended clamping torque (N-m)

RE**: Standard corner radius

SPARE PARTS



Designation	Clamping screw	Wrench 1	Wrench 2 (Optional)
JSDFCR/L1212H07	CSTB-2.5	T-8F	(T-8L)
JSDFCR/L1616H11	CSTB-4SD	T-8F	(T-8L)

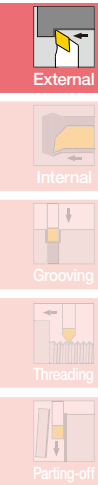

INSERT SELECTION

P	Application areas	Precision finishing	Finish cutting	Medium to finish cutting	M	Application areas	Precision finishing	Finish cutting	Medium to finish cutting		
	Grade	SH725	SH725	SH725		SH725	SH725	SH725	SH725	SH725	
	Breaker Shape	01	JP	JS		JS	01	JP	JS	JS	
Cutting conditions					G094						
P	Application areas	Medium to finish cutting				M	Application areas	Medium to finish cutting			
	Grade	SH725					Grade	SH725			
	Breaker Shape	J10					Breaker Shape	J10			
Cutting conditions					G094						
K	Application areas	Medium to finish cutting				N	Application areas	Precision finishing	Finish cutting	Medium cutting	
	Grade	T515					Grade	DX110	DX140	KS05F	
	Breaker Shape	CM					Breaker Shape	NS	DIA	AL	
Cutting conditions					B020						
S	Application areas	Finish cutting	Medium to finish cutting				H	Application areas	Precision finishing	Finish cutting	
	Grade	SH725	SH725					Grade	BXA10	BXA20	
	Breaker Shape	JS	JS					Breaker Shape	HP	CBN	
Cutting conditions					G094						
					Cutting conditions						
					B026						

Reference pages : JSDFCR/L: Inserts → B121 -, CBN → B193 -, PCD → B214

JS-SDUCL

Screw-on round-shank toolholder with 93° approach angle, for positive 55° rhombic inserts

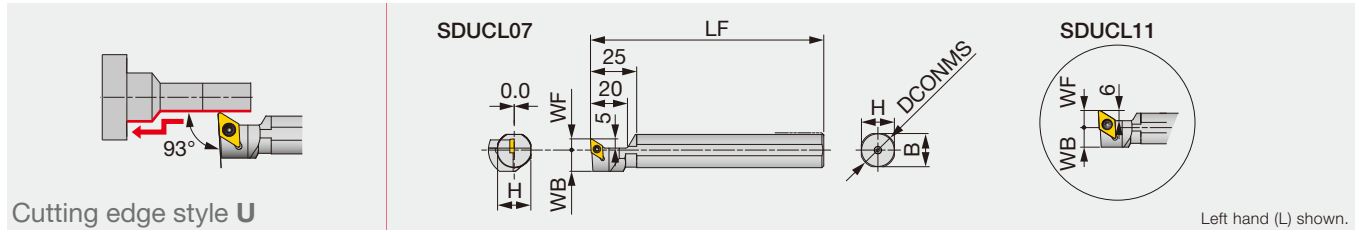

Designation	DCONMS	WF	LF	H	B	WB	RE**	Insert	Torque*
JS19K-SDUCL07	19.05	6	125	18	18	11.5	0.4	DC**0702...	1.2
JS20K-SDUCL07	20	6	125	19	19	11.5	0.4	DC**0702...	1.2
JS22K-SDUCL07	22	6	125	21	21	11.5	0.4	DC**0702...	1.2
JS19K-SDUCL11	19.05	10	125	18	18	11.5	0.8	DC**11T3...	1.2
JS20K-SDUCL11	20	10	125	19	19	11.5	0.8	DC**11T3...	1.2
JS22K-SDUCL11	22	11	125	21	21	11.5	0.8	DC**11T3...	1.2
JS25K-SDUCL11	25	12	125	24	24	12.5	0.8	DC**11T3...	1.2
JS254K-SDUCL11	25.4	12	125	24	24	12.7	0.8	DC**11T3...	1.2

Torque*: Recommended clamping torque (N·m)
RE**: Standard corner radius

SPARE PARTS

Designation	Clamping screw	Wrench
JS**K-SDUCL07	CSTB-2.5	T-8F
JS**K-SDUCL11	CSTB-4SD	T-8F

INSERT SELECTION

P	Application areas	Precision finishing	Finish cutting	Medium to finish cutting	M	Application areas	Precision finishing	Finish cutting	Medium to finish cutting			
	Grade	SH725	SH725	SH725		SH725	Grade	SH725	SH725	SH725		
	Breaker Shape	01	JP	JS	JS	Breaker Shape	01	JS	JS			
	Cutting conditions	G094					Cutting conditions	G094				
P	Application areas	Medium to finish cutting				M	Application areas	Medium to finish cutting				
	Grade	SH725					Grade	SH725				
	Breaker Shape	01					Breaker Shape	01				
	Cutting conditions	G094					Cutting conditions	G094				
K	Application areas	Medium to finish cutting				N	Application areas	Precision finishing	Medium cutting			
	Grade	T515					Grade	DX110	KS05F			
	Breaker Shape	CM					Breaker Shape	NS	AL			
	Cutting conditions	B020					Cutting conditions	B022				
S	Application areas	Finish cutting	Medium to finish cutting				H	Application areas	Precision finishing	Finish cutting		
	Grade	SH725	SH725					Grade	BXA10	BXA20		
	Breaker Shape	JS	JS					Breaker Shape	CBN	CBN		
	Cutting conditions	G094					Cutting conditions	B026				

Reference pages : JS-SDUCL: Inserts → B121 -, CBN → B193 -, PCD → B214

Screw-on round-shank toolholder with 93° approach angle, for DX*U inserts

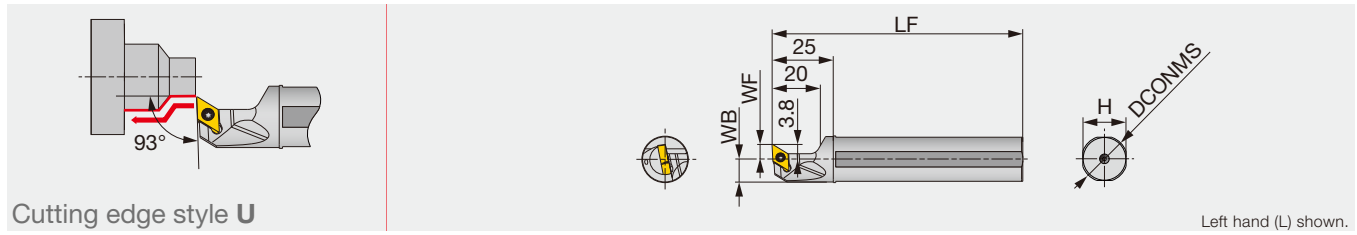

Cutting edge style U

Left hand (L) shown.

Designation	DCONMS	WF	LF	H	WB	RE**	Insert	Torque*
JS14H-SDUXL07	14	6	100	13	6.75	0.2	DX*U0703**L...	0.9
JS159F-SDUXL07	15.875	6	85	15	7.687	0.2	DX*U0703**L...	0.9
JS16F-SDUXL07	16	6	85	15	7.75	0.2	DX*U0703**L...	0.9
JS19G-SDUXL07	19.05	6	90	18	9.275	0.2	DX*U0703**L...	0.9
JS19X-SDUXL07	19.05	6	120	18	9.275	0.2	DX*U0703**L...	0.9
JS20G-SDUXL07	20	6	90	19	9.75	0.2	DX*U0703**L...	0.9
JS20X-SDUXL07	20	6	120	19	9.75	0.2	DX*U0703**L...	0.9
JS22X-SDUXL07	22	10	120	21	10.75	0.2	DX*U0703**L...	0.9
JS25H-SDUXL07	25	10	100	24	12.25	0.2	DX*U0703**L...	0.9
JS254X-SDUXL07	25.4	10	120	24	12.45	0.2	DX*U0703**L...	0.9

Torque*: Recommended clamping torque (N-m) RE**: Standard corner radius
Use left-hand toolholders (L) with left-hand inserts (L).

SPARE PARTS

Designation	Clamping screw	Wrench
JS**-SDUXL07	SR34-514	T-7F

INSERT SELECTION

for Swiss lathes

P	Application areas	Finish cutting	Medium to finish cutting	M	Application areas	Finish cutting	Medium to finish cutting
	Grade	SH725	SH725		Grade	SH725	SH725
Breaker Shape	JSS	JS	Breaker Shape	JSS	JS		
Cutting conditions	G094		Cutting conditions	G094			

for Small CNC lathes

P	Application areas	Finish cutting	Medium cutting	M	Application areas	Finish cutting	Medium cutting	N	Application areas	Medium to finish cutting
	Grade	AH725	AH725		Grade	AH8015	AH8015		Grade	KS05F
Breaker Shape	SS	TS	Breaker Shape	SS	TS	Breaker Shape	SS	TS		
Cutting conditions	G094		Cutting conditions	G094		Cutting conditions	B022			

Reference pages : JS-SDUXL: Inserts → B126 -, Standard cutting conditions → G094

QC12-JSVVXR-CHP

Screw-on modular head with 72.5° approach angle, for VXGU inserts, with high pressure coolant capability

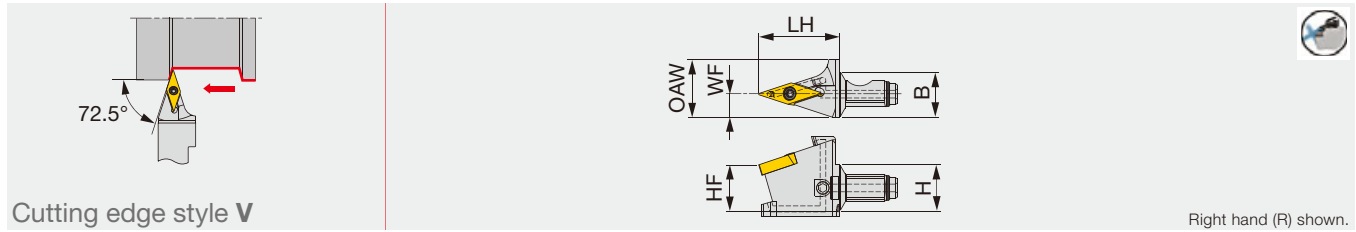

Designation	H	B	LH	HF	WF	OAW	RE**	Insert	Torque*
QC12-JSVVXR09-CHP	12	12	21	12	6	15	0.2	VXGU09T2**L...	0.9

Torque*: Recommended clamping torque (N·m)
 RE**: Standard corner radius
 Use right-hand toolholders (R) with left-hand inserts (L).

SPARE PARTS

Designation	Clamping screw	Coolant unit	Wrench	O-ring
QC12-JSVJ2XR09	SR34-508	-	T-7F	-
QC12-JSVJ2XR09-CHP	SR34-508	S-CU-CHP	T-7F	ORSS-0454.5X1.0NBR70

INSERT SELECTION

P	Application areas	Finish cutting	Medium to finish cutting	M	Application areas	Finish cutting	Medium to finish cutting
	Grade	SH725	SH725		Grade	SH725	SH725
	Breaker Shape	JRP	JS		Breaker Shape	JRP	JS
	Inserts				Inserts		
	Cutting conditions	G094			Cutting conditions	G094	

J-SERIES

JSTBR/L

Screw-on toolholder for back turning

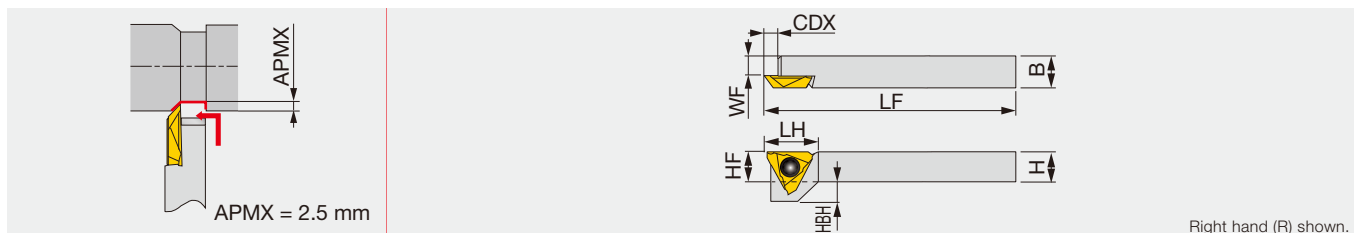

Designation	H	B	LF	LH	CDX	HF	WF	HBH	Insert	Torque*
JSTBR/L1010X3	10	10	120	15	5	10	6	5	JTBR/L3...	1.2
JSTBL1010K3	10	10	125	15	5	10	6	5	JTBR/L3...	1.2
JSTBR/L1212F3	12	12	85	15	5	12	8	3	JTBR/L3...	1.2
JSTBR/L1212X3	12	12	120	15	5	12	8	3	JTBR/L3...	1.2
JSTBR/L1616X3	16	16	120	15	5	16	12	-	JTBR/L3...	1.2

Torque*: Recommended clamping torque (N·m)

SPARE PARTS

Designation	Clamping screw	Wrench 1	Wrench 2 (Optional)
JSTBR/L...	CSTB-4SD	T-8F	(T-8L)

Reference pages : QC12-JSVVXR-CHP: Inserts → **B155**, Shank, Accessory → **G095**, **G096**
 Standard cutting conditions → **G094**
 JSTBR/L: Inserts → **G084**, **G085**, Standard cutting conditions → **G085**

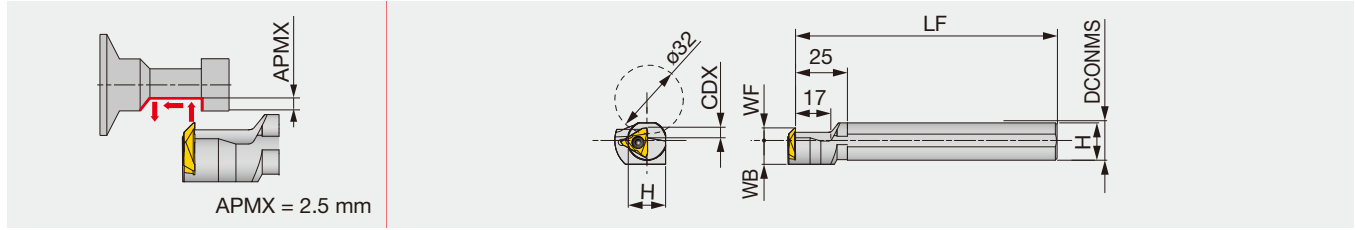

Designation	DCONMS	H	LF	CDX	WF	WB	Insert	Torque*
JS19K-TBL3	19.05	18	125	4.5	6	11.5	JTBR3...	3
JS20K-TBL3	20	19	125	4.5	6	11.5	JTBR3...	3
JS22K-TBL3	22	21	125	4.5	6	11.5	JTBR3...	3
JS25K-TBL3	25.4	24	125	4.5	10	12.7	JTBR3...	3

Torque*: Recommended clamping torque (N-m)

SPARE PARTS

Designation	Clamping screw	Wrench
JS**-TBL3	CSTB-4S	T-15F

INSERT

JTB (Sharp edge)

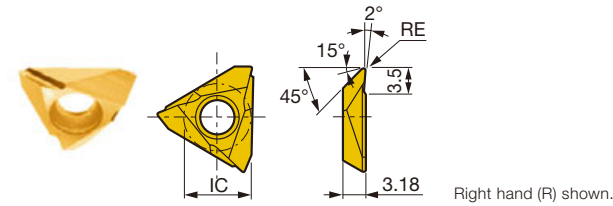

	P	M	K	N	S	H
Steel	★ ☆					
Stainless	★ ☆					
Cast iron	★		☆	☆		
Non-ferrous				★		
Superalloys	☆	☆		★		
Hard materials				★		

★ : First choice
☆ : Second choice

Designation	HAND	RE	Coated		Cermet	Uncoated	IC	Max. depth of cut
			SH725	J740	NS9530	TH10		
JTBR3000F	R	0.03	●	●		●	9.438	2.5
JTBL3000F	L	0.03	●	●		●	9.438	2.5
JTBR3005F	R	0.05	●	●		●	9.438	2.5
JTBL3005F	L	0.05	●	●		●	9.438	2.5
JTBR3010F	R	0.1	●	●	●	●	9.438	2.5
JTBL3010F	L	0.1	●	●	●	●	9.438	2.5
JTBR3015F	R	0.15	●	●			9.438	2.5
JTBL3015F	L	0.15	●	●			9.438	2.5

● : Line up

INSERT

JTBR/L (Honed edge)

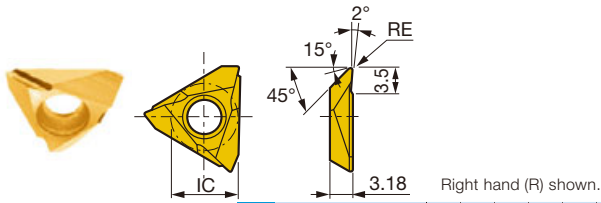

P	Steel	★		★					
M	Stainless	★							
K	Cast iron	★		☆					
N	Non-ferrous								
S	Superalloys	☆							
H	Hard materials								

★ : First choice
☆ : Second choice

Designation	HAND	RE	Coated		Coated cermet						IC	Max. depth of cut	
			J740	J9530									
JTBR3005	R	0.05	●	●								9.438	2.5
JTBL3005	L	0.05	●									9.438	2.5
JTBR3010	R	0.1	●	●								9.438	2.5
JTBL3010	L	0.1	●									9.438	2.5

● : Line up

STANDARD CUTTING CONDITIONS (JTB type insert)

ISO	Workpiece material	Grade	Cutting speed Vc (m/min)	Feed f (mm/rev)
P	Steel (S45C, etc. C45, etc.)	SH725	50 - 200	0.01 - 0.1
		J740	10 - 100	0.01 - 0.1
		NS9530	50 - 150	0.01 - 0.1
		J9530	50 - 150	0.01 - 0.1
M	Free-cutting steel (SUM22, etc. 11SMn28, etc.)	SH725	50 - 200	0.01 - 0.1
		J740	10 - 100	0.01 - 0.1
		NS9530	50 - 150	0.01 - 0.1
		J9530	50 - 150	0.01 - 0.1
N	Stainless steel (SUS304, etc. X5CrNi18-9, etc.)	SH725	50 - 200	0.01 - 0.1
		J740	10 - 100	0.01 - 0.1
		NS9530	50 - 150	0.01 - 0.1
S	Aluminium alloys, Brass (Si < 12%, C3604B, etc. CW614N, etc.)	TH10	10 - 200	0.01 - 0.1
		TH10	10 - 30	0.01 - 0.1
S	Difficult-to-machine material, Titanium alloys (Ti-6Al-4V, etc.)	TH10	10 - 200	0.01 - 0.1
		TH10	10 - 30	0.01 - 0.1

Grade
Insert
Ext. Toolholder
Int. Toolholder
Threading
Grooving
Miniature tool
Milling cutter
Endmill
Drilling tool
Tooling System
User's Guide
Index

A
B
C
D
E
F
G
H
I
J
K
L
M

Parting-off and front turning toolholders

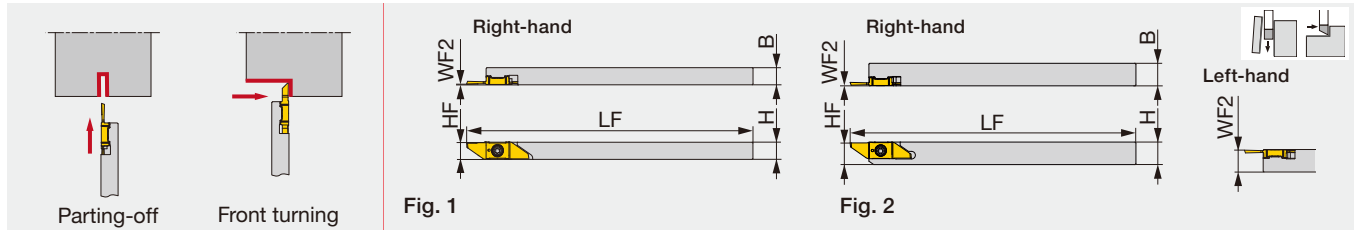

Designation	H	B	LF	HF	WF2 ⁽¹⁾	Insert	Torque*	Fig.
JSXXL0606X05	6	6	120	5.6	5.8	JV*N..., JVN...	1.3	1
JSXXR/L0707X05	7	7	120	6.6	0.2/6.8	JV*N..., JVN...	1.3	1
JSXXR/L0808F05	8	8	85	7.7	0.2/7.8	JV*N..., JVN...	1.3	2
JSXXR/L0808H05	8	8	100	7.7	0.2/7.8	JV*N..., JVN...	1.3	2
JSXXR/L1010H05	10	10	100	9.7	0.2/9.8	JV*N..., JVN...	1.3	2

Torque*: Recommended clamping torque (N-m)

(1) The first value before "/" indicates the WF for the right-hand holder and the second value after "/" for the left-hand holder.

Use the right-hand insert (JV****R...) for a right-hand holder (JSXXR...); the left-hand insert (JV****L...) for a left-hand holder (JSXXL...).

SPARE PARTS

Designation	Clamping screw	Wrench
JSXXR...05	CSTB-2.5L054DL	T-7F
JSXXL...05	CSTB-2.5L054DR	T-7F

INSERT

JVFN45R/L (For front turning)

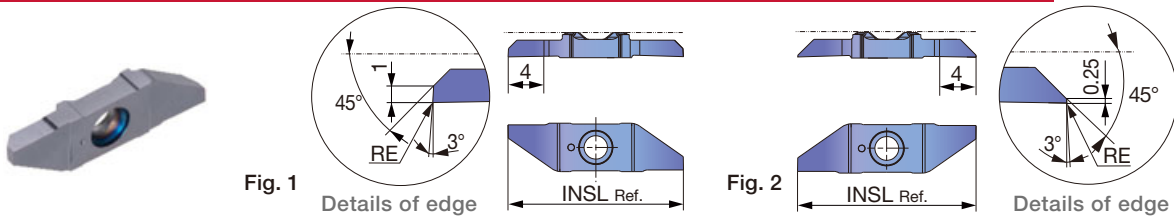

	Steel	Stainless	Cast iron	Non-ferrous	Superalloys	Hard materials
P	★					
M		★				
K			★			
N				★		
S					★	
H						★

★ : First choice

Designation	HAND	RE	Coated				INSL	Fig.
			SH725					
JVFN45R0310F	R	0	●				21	1
JVFN45L0302FL	L	0	●				21	2

● : Line up

INSERT

JVNR/L (Semi-finished blanks)

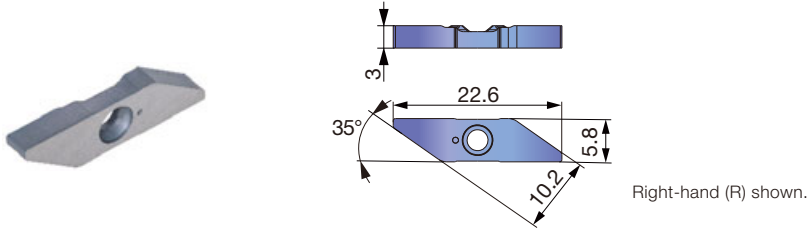

P	Steel	★					
M	Stainless	★					
K	Cast iron						
N	Non-ferrous	★					
S	Superalloys	★					
H	Hard materials						

★ : First choice

Designation	HAND	Uncoated				
		KS15F				
JVNR30	R	●				
JVNL30	L	●				

● : Line up

STANDARD CUTTING CONDITIONS

ISO	Workpiece materials	Grade	Cutting speed V _c (m/min)	Feed f (mm/rev)
P	Low carbon steels S15C, SS400, etc. C15E4, E275A, etc.	SH725	50 - 180	0.01 - 0.03
	Carbon steels, Alloy steels S55C, SCM440, etc. C55, 42CrMo4, etc.	SH725	50 - 180	0.01 - 0.03
	Free cutting steels SUH22, SUH23, etc.	SH725	50 - 180	0.01 - 0.03
M	Stainless steels SUS304, X5CrNi18-9, etc.	SH725	50 - 120	0.01 - 0.03
N	Aluminium alloys A5056, A6061, etc.	SH725	150 - 200	0.01 - 0.03
	Copper alloys C2600, C280C, etc.	SH725	100 - 200	0.01 - 0.03
S	Titanium alloys Ti-6Al-4V, etc.	SH725	30 - 80	0.01 - 0.03
	Superalloys Inconel718, etc.	SH725	30 - 80	0.01 - 0.03

Grade
Insert
Ext. Toolholder
Int. Toolholder
Threading
Grooving
Miniature tool
Milling cutter
Endmill
Drilling tool
Tooling System
User's Guide
Index

A
B
C
D
E
F
G
H
I
J
K
L
M

Screw-on toolholder for front/reverse turning and external grooving

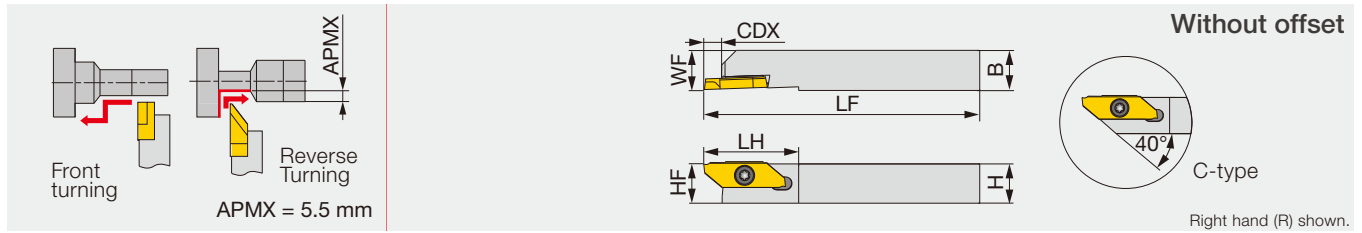

Designation	H	B	LF	LH	CDX	HF	WF	Insert
JSXGR/L1010K8-C	10	10	125	29	6.7	10	10	JXFR/L8..., JXRR/L8...
JSXGR/L1212K8-C	12	12	125	29	6.7	12	12	JXFR/L8..., JXRR/L8...
JSXGR/L1616K8	16	16	125	29	6.5	16	16	JXFR/L8..., JXRR/L8...
JSXGR/L2020K8	20	20	125	29	6.5	20	20	JXFR/L8..., JXRR/L8...
JSXGR/L2525K8	25	25	125	29	6.5	25	25	JXFR/L8..., JXRR/L8...

Can be used with JXG insert for parting and grooving.
Can be wrenched also from the back with a double-head screw.

SPARE PARTS

Designation	Clamping screw	Wrench 1	Wrench 2 (Optional)
JSXGR/L...	CSTB-4SD	T-8F	(T-8L)

INSERT

JXF (For front turning)

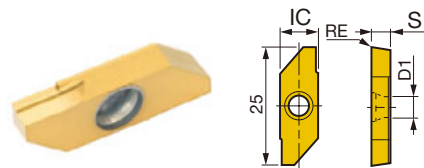

P Steel	★					
M Stainless	★					
K Cast iron						
N Non-ferrous	★					
S Superalloys	★					
H Hard materials						

★ : First choice

Designation	HAND	RE	Coated		Uncoated		IC	S	D1
			J740	TH10	J740	TH10			
JXFR8000F	R	0.03	●		●		8	3.97	4.4
JXFR8010F	R	0.1	●		●		8	3.97	4.4

● : Line up

JXR (For reverse turning)

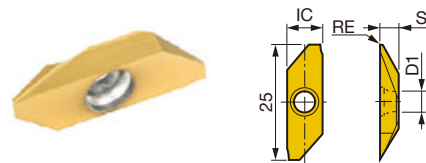

P Steel	★					
M Stainless	★					
K Cast iron						
N Non-ferrous	★					
S Superalloys	★					
H Hard materials						

★ : First choice

Designation	HAND	RE	Coated		Uncoated		IC	S	D1
			J740	TH10	J740	TH10			
JXRR8000F	R	0.03	●		●		8	3.97	4.4
JXRR8010F	R	0.1	●		●		8	3.97	4.4

● : Line up

QC12-JSEGR

Screw-on modular head for back turning

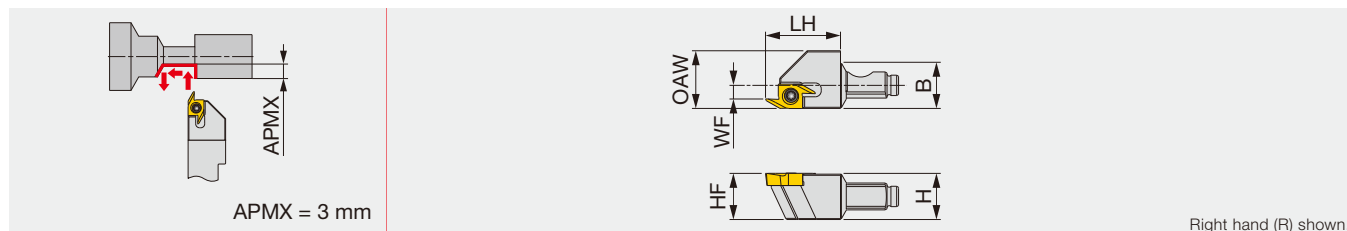

Designation	H	B	LH	HF	WF	OAW	Insert	Torque*
QC12-JSEGR10	12	12	19.5	12	3.5	15	J10ER...	1.2

Torque*: Recommended clamping torque (N-m)

QC12-JSEGR-CHP

Screw-on modular head for back turning, with high pressure coolant capability

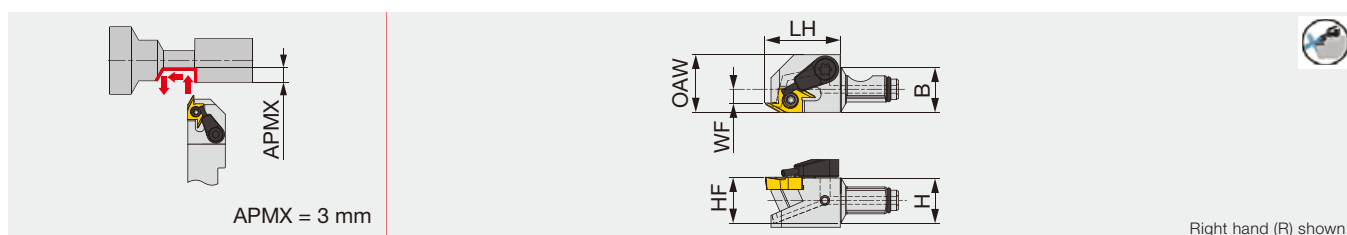

Designation	H	B	LH	HF	WF	OAW	Insert	Torque*
QC12-JSEGR10-CHP	12	12	19.5	12	3.5	15	J10ER...	1.2

Torque*: Recommended clamping torque (N-m)

JSEGR/L

Screw-on toolholder for back turning

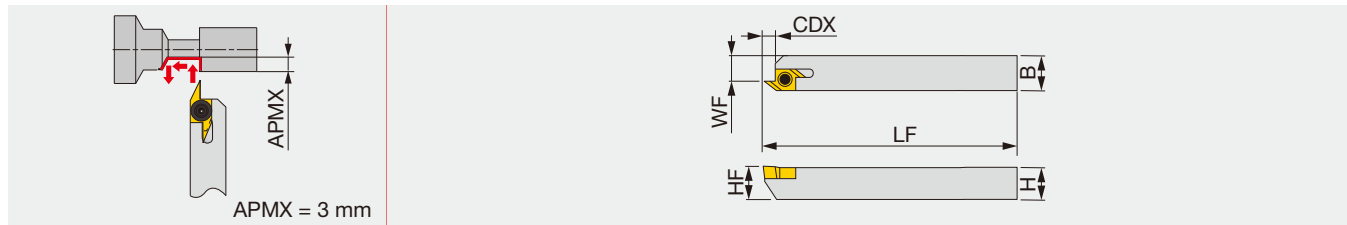

Designation	H	B	LF	CDX	HF	WF	Insert	Torque*
JSEGR/L1010K10	10	10	125	3.3	10	7.5	J10ER/L...	1.2
JSEGR/L1212K10	12	12	125	3.3	12	9.5	J10ER/L...	1.2
JSEGR/L1616K10	16	16	125	3.3	16	13.5	J10ER/L...	1.2

Torque*: Recommended clamping torque (N-m)

SPARE PARTS

Designation	Clamping screw	Coolant unit	Wrench	Wrench 2 (Optional)	O-ring
QC12-JSEGR10	CSTB-2.5		T-8F		
QC12-JSEGR10-CHP	CSTB-2.5	S-CU-CHP	T-8F		ORSS-0454.5X1.0NBR70
JSEGR/L...	CSTB-2.5		T-8F	(T-8L)	

Reference pages : QC12-JSEGR, QC12-JSEGR-CHP, JSEGR/L: Inserts → **G090**
Shank, Accessory → **G095, G096**, Standard cutting conditions → **G091**

INSERT

J10E (Sharp edge)

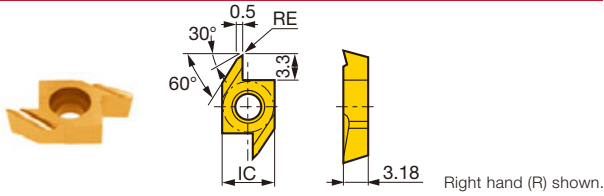

P	Steel	★	☆		★							
M	Stainless	★	☆									
K	Cast iron	★			☆			☆				
N	Non-ferrous							★				
S	Superalloys	☆						★				
H	Hard materials							★				

★ : First choice
☆ : Second choice

Designation	HAND	RE	Coated		Cermet	Uncoated		IC	Max. depth of cut
			SH725	J740	NS9530	TH10			
J10ER/L005BF	R	0.05	●	●			●	6.35	3
J10ER/L005BF	L	0.05	●	●			●	6.35	3
J10ER/L010BF	R	0.1	●	●			●	6.35	3
J10ER/L010BF	L	0.1	●	●			●	6.35	3
J10ER/L015BF	R	0.15	●		●			6.35	3
J10ER/L015BF	L	0.15	●		●			6.35	3

● : Line up

J10E (Honed edge)

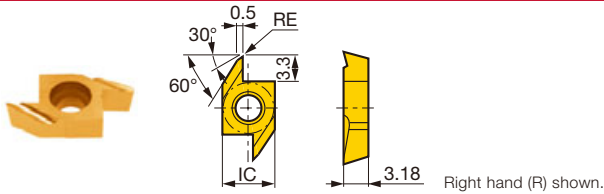

P	Steel	★			★							
M	Stainless	★										
K	Cast iron	★			☆							
N	Non-ferrous											
S	Superalloys	☆										
H	Hard materials											

★ : First choice
☆ : Second choice

Designation	HAND	RE	Coated	Coated cermet			IC	Max. depth of cut
			J740	J9530				
J10ER005B	R	0.05	●	●			6.35	3
J10EL005B	L	0.05	●				6.35	3
J10ER010B	R	0.1	●	●			6.35	3
J10EL010B	L	0.1	●				6.35	3

● : Line up

Reference pages : Toolholder → **G089**

STANDARD CUTTING CONDITIONS (J10E type insert)

ISO	Workpiece material	Grade	Cutting speed Vc (m/min)	Feed f (mm/rev)
P	Steel S45C, etc. C45, etc.	SH725	50 - 200	0.01 - 0.1
		J740	10 - 100	0.01 - 0.1
		NS9530	50 - 150	0.01 - 0.1
		J9530	50 - 150	0.01 - 0.1
	Free-cutting steel SUM22, etc. 11SMn28, etc.	SH725	50 - 200	0.01 - 0.1
		J740	10 - 100	0.01 - 0.1
M	Stainless steel SUS303, SUS304 etc. X10CrNiS18-9, etc.	SH725	50 - 200	0.01 - 0.1
		J740	10 - 100	0.01 - 0.1
		NS9530	50 - 150	0.01 - 0.1
		J9530	50 - 150	0.01 - 0.1
N	Aluminium alloys, Brass Si < 12% C3604B, etc. CW614N, etc.	TH10	10 - 200	0.01 - 0.1
S	Difficult-to-machine material, Titanium alloys Ti-6Al-4V, etc.	TH10	10 - 30	0.01 - 0.1

INSERT

10E (Insert blank)

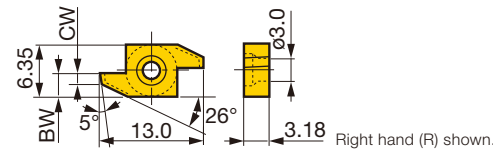

Designation	HAND	Uncoated	
		TH10	
10ER100B	R	●	
10EL100B	L	●	
10ER150B	R	●	
10EL150B	L	●	

● : Line up

Note: Right hand holder (JSEGR...) use right hand insert (10ER...) and left hand holder (JSEGL...) use left hand insert (10EL...)

10E (Insert blank)

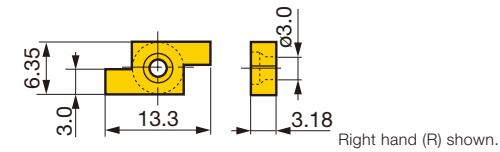

Designation	HAND	Uncoated	
		TH10	
10ER300	R	●	
10EL300	L	●	

● : Line up

Note: Right hand holder (JSEGR...) use right hand insert (10ER...) and left hand holder (JSEGL...) use left hand insert (10EL...)

Formed examples of insert blanks

Front turning

Back turning

Threading

Grooving

Parting-off

Notes:

- Front relief angle, side relief angle, edge width can be ground depending on the application.
- Insert blanks can be formed to a profiling tool which has a width up to 3 mm

Standard cutting conditions

Operations		Workpiece material			
		Carbon steels	Stainless steels	Brass	
Lateral feed (external turning)	Cutting speed (m/min)	~ 100	~ 50	~ 200	
	Feed (mm/rev)	Roughing	~ 0.06	~ 0.03	~ 0.1
		Medium	~ 0.03	~ 0.025	~ 0.06
	Finishing	~ 0.02	~ 0.015	~ 0.04	
Parting-off Grooving Forming	Cutting speed (m/min)	~ 80	~ 30	~ 150	
	Feed (mm/rev)	Roughing	~ 0.02	~ 0.015	~ 0.05
		Medium	~ 0.015	~ 0.01	~ 0.03
	Finishing	~ 0.01	~ 0.008	~ 0.015	

Screw-on toolholder for back turning and threading

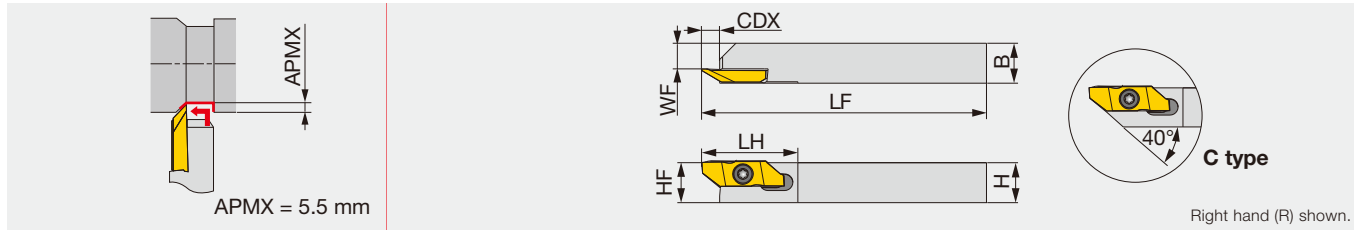

Designation	H	B	LF	LH	CDX	HF	WF	Insert
JSXBR/L1010K8-C	10	10	125	29	6.7	10	5.7	JXBR/L8..., JXT*R...
JSXBR/L1212K8-C	12	12	125	29	6.7	12	7.7	JXBR/L8..., JXT*R...
JSXBR/L1616K8	16	16	125	29	6.4	16	11.7	JXBR/L8..., JXT*R...
JSXBR/L2020K8	20	20	125	29	6.4	20	15.7	JXBR/L8..., JXT*R...
JSXBR/L2525K8	25	25	125	29	6.4	25	20.7	JXBR/L8..., JXT*R...

Can be used with JXT insert for threading.
Can be wrenched also from the back with a double-head screw.

SPARE PARTS

Designation	Clamping screw	Wrench 1	Wrench 2 (Optional)
JSXBR/L...	CSTB-4SD	T-8F	(T-8L)

INSERT

JXB (Sharp edge)

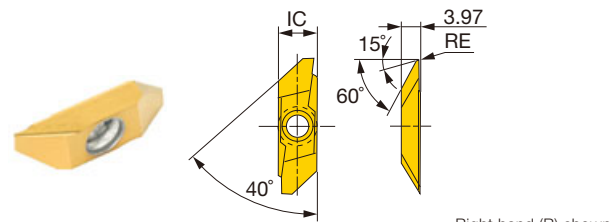

P	Steel	★							
M	Stainless	★							
K	Cast iron	★		☆					
N	Non-ferrous		★						
S	Superalloys	☆	★						
H	Hard materials		★						

★ : First choice
☆ : Second choice

Designation	HAND	RE	Coated		Uncoated		IC	Max. depth of cut
			J740	TH10				
JXBR8000F	R	0.03	●	●			8	5.5
JXBL8000F	L	0.03	●	●			8	5.5
JXBR8005F	R	0.05	●	●			8	5.5
JXBL8005F	L	0.05	●	●			8	5.5
JXBR8010F	R	0.1	●	●			8	5.5
JXBL8010F	L	0.1	●	●			8	5.5
JXBR8015F	R	0.15	●	●			8	5.5
JXBL8015F	L	0.15	●	●			8	5.5

● : Line up

JXB (Honed edge)

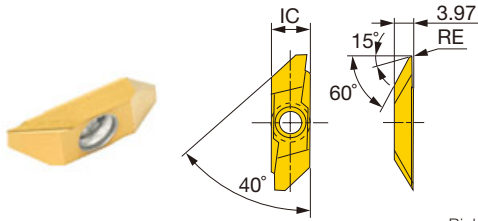

Right hand (R) shown.

P	Steel	★								
M	Stainless	★								
K	Cast iron	★								
N	Non-ferrous									
S	Superalloys	☆								
H	Hard materials									

★ : First choice
☆ : Second choice

Designation	HAND	RE	Coated								IC	Max. depth of cut
			J740									
JXBR/L8005	R	0.05	●								8	5.5
JXBR/L8005	L	0.05	●								8	5.5
JXBR/L8010	R	0.1	●								8	5.5
JXBR/L8010	L	0.1	●								8	5.5
JXBR/L8015	R	0.15	●								8	5.5
JXBR/L8015	L	0.15	●								8	5.5

● : Line up

STANDARD CUTTING CONDITIONS (JXB type insert)

ISO	Workpiece material	Grade	Cutting speed Vc (m/min)	Feed: f (mm/rev)	
				Grooving	Turning
P	General steel S45C, etc. C45, etc.	J740	10 - 100	0.01 - 0.03	0.02 - 0.1
	Free-cutting steel SUM22, etc. 11SMn28, etc.	J740	10 - 100	0.01 - 0.03	0.02 - 0.1
M	Stainless steel SUS303, etc. X10CrNiS18-9, etc.	J740	10 - 100	0.01 - 0.02	0.02 - 0.08
N	Aluminium alloys, Brass Si < 12% C3604B, etc. CW614N, etc	TH10	50 - 200	0.01 - 0.05	0.02 - 0.1
S	Difficult-to-machine material, Titanium alloys Ti-6Al-4V, etc.	TH10	10 - 30	0.01 - 0.02	0.02 - 0.05

Grade
Insert
Ext. Toolholder
Int. Toolholder
Threading
Grooving
Miniature tool
Milling cutter
Endmill
Drilling tool
Tooling System
User's Guide
Index

A
B
C
D
E
F
G
H
I
J
K
L
M

Technical Guide

MINIFORCE STANDARD CUTTING CONDITIONS FOR EXTERNAL TURNING

Applications	ISO	Workpiece material	Priority	Chip breaker	Grade	Cutting speed Vc (m/min)	Depth of cut ap (mm)	Feed f (mm/rev)
For swiss type automatic lathes	P	Low carbon steel SS400, etc. E275A, etc. Carbon steel S45C, etc. C45, etc. Low alloy steel SCM415, etc. 18CrMo4, etc. Alloy steel SCM440, etc. 42CrMo4, etc.	First choice	JS	SH725	50 - 180	0.1 - 3	0.03 - 0.1
			With high sharpness	JSS	SH725	50 - 180	0.1 - 1.5	0.03 - 0.1
	M	Stainless steel (Austenitic) SUS304, etc. X5CrNi18-9, etc. Stainless steel (Martensitic and ferritic) SUS430, etc. X6Cr17, etc. Stainless steel (Precipitation hardened) SUS630, etc. X5CrNiCuNb16-4, etc.	First choice	JS	SH725	50 - 180	0.1 - 1.25	0.03 - 0.1
			With high sharpness	JSS	SH725	50 - 180	0.1 - 1.5	0.03 - 0.1
For small size CNC lathes	P	Low carbon steel SS400, etc. E275A, etc. Carbon steel S45C, etc. C45, etc. Low alloy steel SCM415, etc. 18CrMo4, etc. Alloy steel SCM440, etc. 42CrMo4, etc.	First choice	SS	AH725	50 - 180	0.15 - 1.5	0.05 - 0.2
				TS	AH725	50 - 180	0.3 - 2	0.08 - 0.3
			For improved surface finish	SS	NS9530	50 - 200	0.15 - 1.5	0.05 - 0.2
				TS	NS9530	50 - 200	0.3 - 2	0.08 - 0.3
		For wear resistance	SS	GT9530	50 - 250	0.15 - 1.5	0.05 - 0.2	
		TS	GT9530	50 - 250	0.3 - 2	0.08 - 0.3		
M	Stainless steel (Austenitic) SUS304, etc. X5CrNi18-9, etc. Stainless steel (Martensitic and ferritic) SUS430, etc. X6Cr17, etc. Stainless steel (Precipitation hardened) SUS630, etc. X5CrNiCuNb16-4, etc.	First choice	SS	AH8015	50 - 150	0.15 - 1.5	0.05 - 0.2	
		For impact resistance	TS	AH8015	50 - 150	0.3 - 2	0.08 - 0.3	

J-SERIES STANDARD CUTTING CONDITIONS

ISO	Workpiece material	Priority	Grade	Cutting speed Vc (m/min)	Feed f (mm/rev)
P	Low carbon steel SS400, etc. E275A, etc. Carbon steel S45C, etc. C45, etc. Low alloy steel SCM415, etc. 18CrMo4, etc. Alloy steel SCM440, etc. 42CrMo4, etc.	First choice	SH725	50 - 200	0.01 - 0.2
		For impact resistance	AH725	50 - 200	0.01 - 0.2
M	Stainless steel (Austenitic) SUS304, etc. X5CrNi18-9, etc. Stainless steel (Martensitic and ferritic) SUS430, etc. X6Cr17, etc. Stainless steel (Precipitation hardened) SUS630, etc. X5CrNiCuNb16-4, etc.	First choice	SH725	50 - 200	0.01 - 0.2
		For impact resistance	AH725	50 - 200	0.01 - 0.2
S	Titanium alloys Ti-6Al-4V, etc. Superalloys Inconel718, etc.	First choice	SH725	20 - 80	0.01 - 0.2
		For impact resistance	AH725	20 - 80	0.01 - 0.2

ACCESSORY

MODUM^{INI}TURN QC-1212

Shank for modular heads

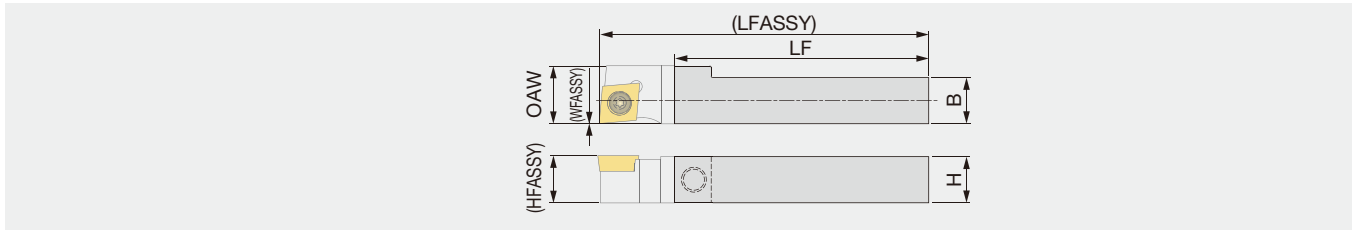

Designation	H	B	WFASSY	LF	OAW	HFASSY	LFASSY ⁽¹⁾	Torque*
QC-1212F	12	12	0	65	15	12	85	3
QC-1212X	12	12	0	100	15	12	120	3

Torque* : Recommended clamping torque (N·m)
(1) The size is true when the modular head with LH = 19.5 mm is mounted.

QC-1212-CHP

Shank for modular heads, with high pressure coolant capability

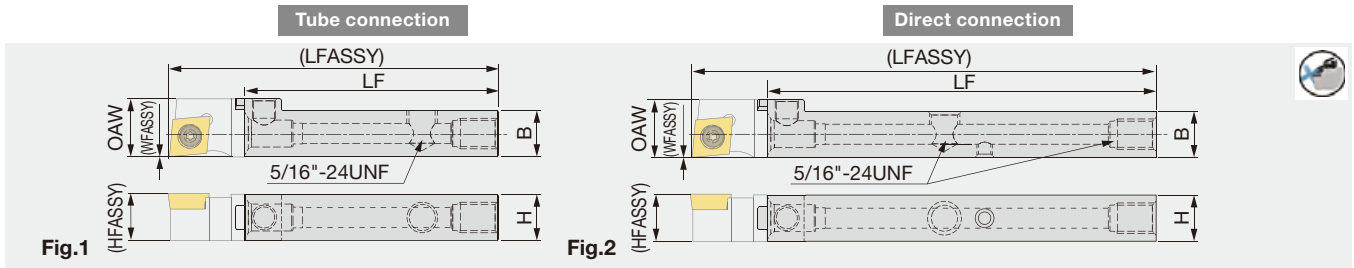

Designation	H	B	LF	WFASSY	OAW	HFASSY	LFASSY ⁽¹⁾	Torque*	Fig.
QC-1212F-CHP	12	12	65	0	15	12	85	3	1
QC-1212X-CHP ^(*)	12	12	100	0	15	12	120	3	2

Torque* : Recommended clamping torque (N·m)
Through-coolant shank
(*) : Compatible to the direct internal coolant supply system without the use of external coolant hose.
(1) The size is true when the modular head with LH = 19.5 mm is mounted.

QC-1216-F15-CHP

Stepped-head shank for modular heads, with high pressure coolant capability

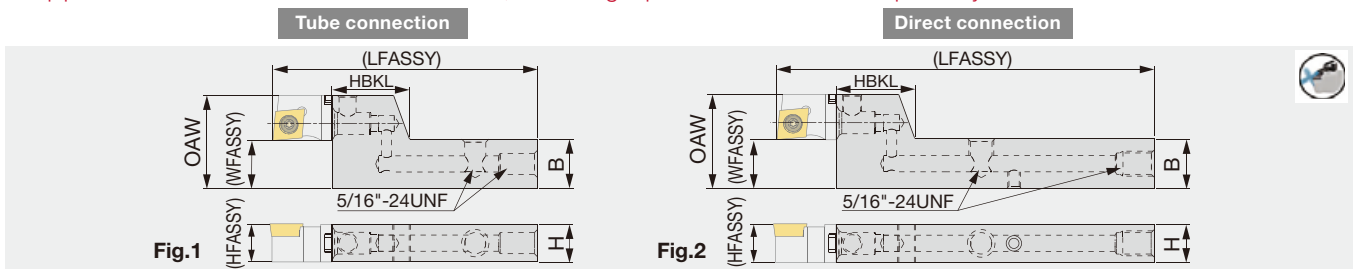

Designation	H	B	LF	OAW	WFASSY	HFASSY	LFASSY ⁽¹⁾	HBKL	Torque*	Fig.
QC-1216F-F15-CHP	12	16	65	30	15	12	85	25	3	1
QC-1216X-F15-CHP ⁽¹⁾	12	16	100	30	15	12	120	25	3	2

Torque* : Recommended clamping torque (N·m)
QC12 heads only can be mounted on these shanks.
(*) : Compatible to the direct internal coolant supply system without the use of external coolant hose.
(1) The size is true when the modular head with LH = 19.5 mm is mounted.

SPARE PARTS

Designation	Clamping screw	Wrench	Coolant plug	Wrench	DirectJet plug	Wrench
QC-1212*	SRM6X0.5-26977	P-3	-	-	-	-
QC-1212F-CHP, QC-1216F-F15-CHP	SRM6X0.5-26977	P-3	SR5/16UNFTL360	P-4	-	-
QC-1212X-CHP, QC-1216X-F15-CHP	SRM6X0.5-26977	P-3	SR5/16UNFTL360	P-4	SSHM4-6-TB	P-2

Grade
Insert
Ext. Toolholder
Int. Toolholder
Threading
Grooving
Miniature tool
Milling cutter
Endmill
Drilling tool
Tooling System
User's Guide
Index



Modular head holder for insert change

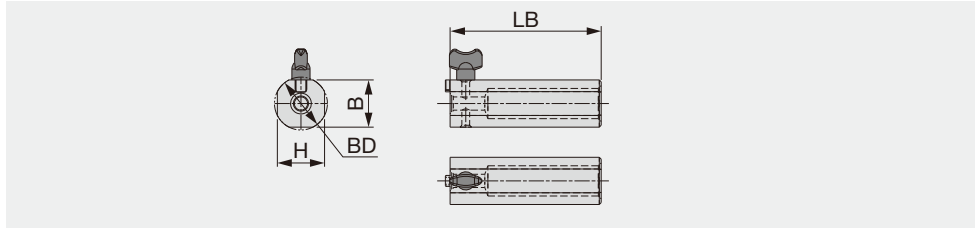

Designation	BD	LB	H	B
QC-12D28EXC	28	80	25	25

Note: This is a dedicated modular-head holder designed to facilitate insert changes. Do not use this holder for machining as it may cause damages to tool, workpiece, machine, and possible human injury.

SPARE PARTS



Designation	Fixing screw
QC-12D28EXC	KNOBM5X10



ModuMini-Turn modular heads are small. When it is difficult to change inserts while holding the modular head with fingers, use the dedicated holder to facilitate insert changes.

QC12-STOPPER

Protective plug for shank

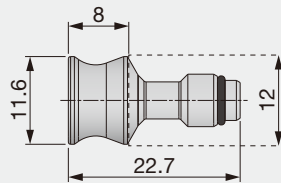

Designation

QC12-STOPPER

SPARE PARTS



Designation	O-ring
QC12-STOPPER	ORSS-0454.5X1.0NBR70

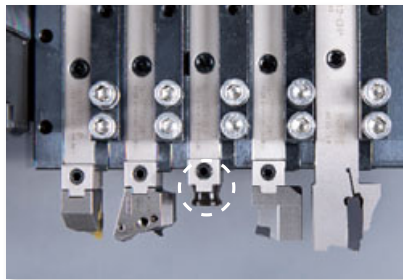

The cutting head located in the feed direction of the Y-axis tool can be removed to make room for machining larger-sized barstock. If this is the case, attach the plug to the shank to protect the coupling surface from chips, as well as prevent coolant leakage during machining.

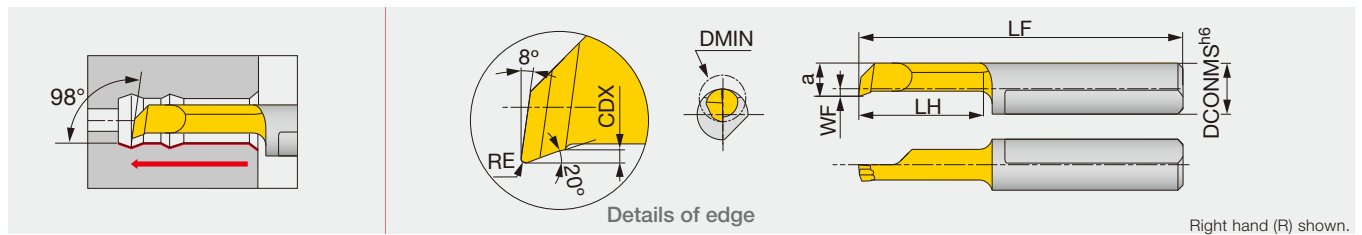

Designation	SH725	DMIN	DCONMS	WF	a	LF	LH	CDX	RE ^{+0.05} ₀
TBTR04045005-D010	●	1	4	-1.1	0.9	21	4.5	0.1	0.05
TBTR04065005-D010	●	1	4	-1.1	0.9	23	6.5	0.1	0.05
TBTR04040005-D020	●	2	4	-0.3	1.7	20.5	4	0.1	0.05
TBTR04090005-D020	●	2	4	-0.3	1.7	25.5	9	0.1	0.05
TBTR04140005-D020	●	2	4	-0.3	1.7	30.5	14	0.1	0.05
TBTR/L04090010-D028	●	2.8	4	0.9	2.6	25.5	9	0.2	0.1
TBTR04150010-D028	●	2.8	4	0.9	2.6	31.5	15	0.2	0.1
TBTR04190010-D028	●	2.8	4	0.9	2.6	35.5	19	0.2	0.1
TBTR04090010-D040	●	4	4	1.5	3.5	25.5	9	0.3	0.1
TBTR04150010-D040	●	4	4	1.5	3.5	31.5	15	0.3	0.1
TBTR04190010-D040	●	4	4	1.5	3.5	35.5	19	0.3	0.1
TBTR04230010-D040	●	4	4	1.5	3.5	39.5	23	0.3	0.1
TBTR04270010-D040	●	4	4	1.5	3.5	43.5	27	0.3	0.1
TBTR07090015-D050	●	5	7	0.9	4.4	25	9	0.5	0.15
TBTR07140015-D050	●	5	7	0.9	4.4	30	14	0.5	0.15
TBTR07190015-D050	●	5	7	0.9	4.4	35	19	0.5	0.15
TBTR07240015-D050	●	5	7	0.9	4.4	40	24	0.5	0.15
TBTR07290015-D050	●	5	7	0.9	4.4	45	29	0.5	0.15
TBTR07340015-D050	●	5	7	0.9	4.4	50	34	0.5	0.15
TBTR07140015-D060	●	6	7	1.8	5.3	30	14	0.5	0.15
TBTR/L07210015-D060	●	6	7	1.8	5.3	37	21	0.5	0.15
TBTR07240015-D060	●	6	7	1.8	5.3	40	24	0.5	0.15
TBTR07290015-D060	●	6	7	1.8	5.3	45	29	0.5	0.15
TBTR07340015-D060	●	6	7	1.8	5.3	50	34	0.5	0.15
TBTR07410015-D060	●	6	7	1.8	5.3	57	41	0.5	0.15
TBTR07190015-D068	●	6.8	7	2.8	6.3	35	19	0.6	0.15
TBTR07240015-D068	●	6.8	7	2.8	6.3	40	24	0.6	0.15
TBTR07290015-D068	●	6.8	7	2.8	6.3	45	29	0.6	0.15
TBTR07340015-D070	●	7	7	2.8	6.3	50	34	0.6	0.15
TBTR07390015-D070	●	7	7	2.8	6.3	55	39	0.6	0.15
TBTR07440015-D070	●	7	7	2.8	6.3	60	44	0.6	0.15
TBTR07490015-D070	●	7	7	2.8	6.3	65	49	0.6	0.15

● : Line up



Solid boring bar for boring, profiling, and chamfering

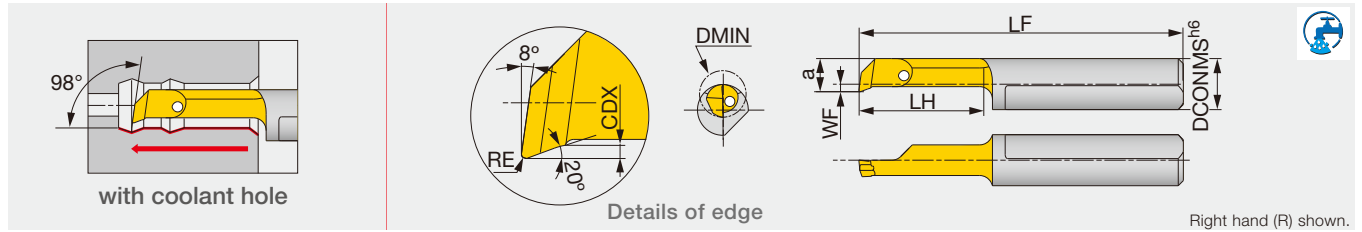

Right hand (R) shown.

Designation	SH730	DMIN	DCONMS	WF	a	LF	LH	CDX	RE ^{+0.05} ₀
JBTR04020004-D006	●	0.6	4	-	0.5	18.5	2	0.08	0.04
JBTR04030004-D006	●	0.6	4	-	0.5	19.5	3	0.08	0.04
JBTR04045005-D010	●	1	4	-	0.9	21	4.5	0.1	0.05
JBTR04065005-D010	●	1	4	-	0.9	23	6.5	0.1	0.05
JBTR04040005-D020	●	2	4	-	1.7	20.5	4	0.1	0.05
JBTR04090005-D020	●	2	4	-	1.7	25.5	9	0.1	0.05
JBTR04140005-D020	●	2	4	-	1.7	30.5	14	0.1	0.05
JBTR/L04090010-D028	●	2.8	4	0.6	2.6	25.5	9	0.2	0.1
JBTR/L04150010-D028	●	2.8	4	0.6	2.6	31.5	15	0.2	0.1
JBTR/L04190010-D028	●	2.8	4	0.6	2.6	35.5	19	0.2	0.1
JBTR/L04090010-D040	●	4	4	1.5	3.5	25.5	9	0.3	0.1
JBTR/L04150010-D040	●	4	4	1.5	3.5	31.5	15	0.3	0.1
JBTR/L04190010-D040	●	4	4	1.5	3.5	35.5	19	0.3	0.1
JBTR04230010-D040	●	4	4	1.5	3.5	39.5	23	0.3	0.1
JBTR04270010-D040	●	4	4	1.5	3.5	43.5	27	0.3	0.1
JBTR/L07090015-D050	●	5	7	0.9	4.4	25	9	0.5	0.15
JBTR/L07140015-D050	●	5	7	0.9	4.4	30	14	0.5	0.15
JBTR/L07190015-D050	●	5	7	0.9	4.4	35	19	0.5	0.15
JBTR/L07240015-D050	●	5	7	0.9	4.4	40	24	0.5	0.15
JBTR/L07290015-D050	●	5	7	0.9	4.4	45	29	0.5	0.15
JBTR07340015-D050	●	5	7	0.9	4.4	50	34	0.5	0.15
JBTR/L07140015-D060	●	6	7	1.8	5.3	30	14	0.5	0.15
JBTR/L07210015-D060	●	6	7	1.8	5.3	37	21	0.5	0.15
JBTR/L07240015-D060	●	6	7	1.8	5.3	40	24	0.5	0.15
JBTR/L07290015-D060	●	6	7	1.8	5.3	45	29	0.5	0.15
JBTR07340015-D060	●	6	7	1.8	5.3	50	34	0.5	0.15
JBTR07410015-D060	●	6	7	1.8	5.3	57	41	0.5	0.15
JBTR/L07190015-D068	●	6.8	7	2.8	6.3	35	19	0.6	0.15
JBTR07240015-D068	●	6.8	7	2.8	6.3	40	24	0.6	0.15
JBTR/L07290015-D068	●	6.8	7	2.8	6.3	45	29	0.6	0.15
JBTR/L07340015-D070	●	7	7	2.8	6.3	50	34	0.6	0.15
JBTR07390015-D070	●	7	7	2.8	6.3	55	39	0.6	0.15
JBTR07440015-D070	●	7	7	2.8	6.3	60	44	0.6	0.15
JBTR07490015-D070	●	7	7	2.8	6.3	65	49	0.6	0.15

● : Line up

Reference pages : JBTR/L: Standard cutting conditions → **G109**

TBPR

Solid boring bar for boring and chamfering

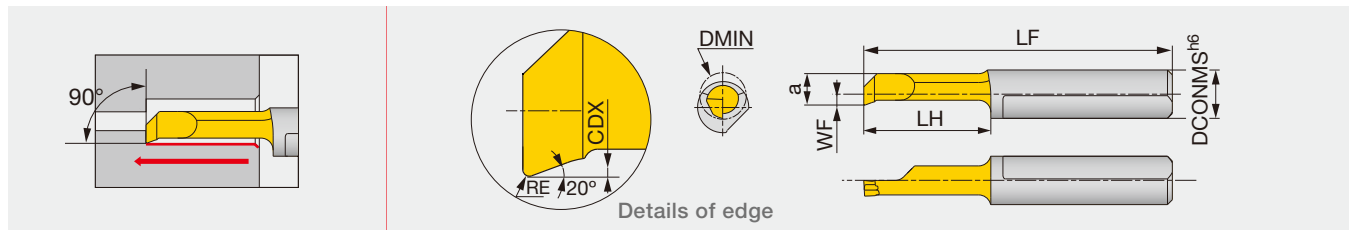

Designation	SH725	DMIN	DCONMS	WF	a	LF	LH	CDX	RE ^{+0.05} ₀
TBPR04090010-D028	●	2.8	4	0.9	2.6	25.5	9	0.2	0.1
TBPR04150010-D040	●	4	4	1.5	3.5	31.5	15	0.3	0.1
TBPR07140015-D050	●	5	7	0.9	4.4	30	14	0.5	0.15
TBPR07190015-D050	●	5	7	0.9	4.4	35	19	0.5	0.15

● : Line up

JBPR

Solid boring bar for boring and chamfering

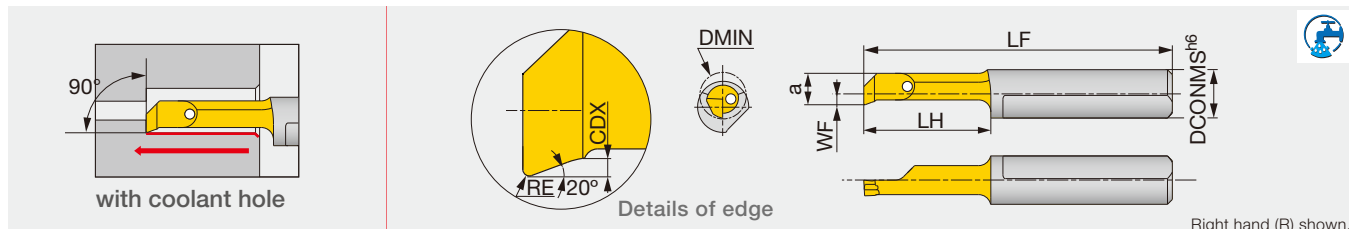

Designation	SH730	DMIN	DCONMS	WF	a	LF	LH	CDX	RE ^{+0.05} ₀
JBPR04090010-D028	●	2.8	4	0.9	2.6	25.5	9	0.2	0.1
JBPR04150010-D028	●	2.8	4	0.9	2.6	31.5	15	0.2	0.1
JBPR04090010-D040	●	4	4	1.5	3.5	25.5	9	0.3	0.1
JBPR04150010-D040	●	4	4	1.5	3.5	31.5	15	0.3	0.1
JBPR07140015-D050	●	5	7	0.9	4.4	30	14	0.5	0.15
JBPR07190015-D050	●	5	7	0.9	4.4	35	19	0.5	0.15

● : Line up

TBUR

Solid boring bar for back boring and chamfering

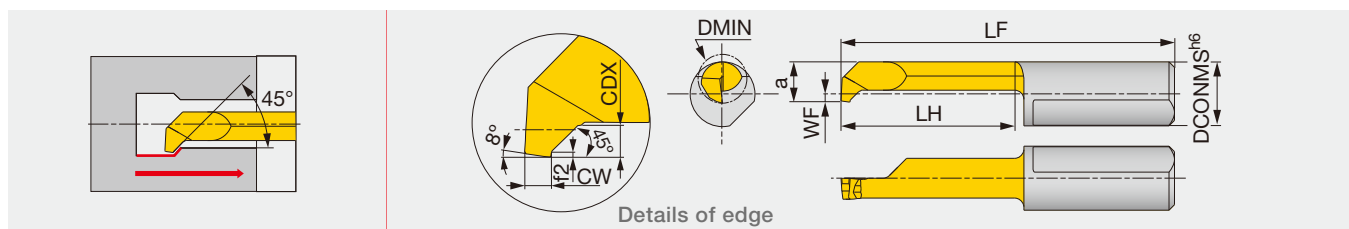

Designation	SH725	DMIN	DCONMS	WF	a	LF	LH	f2	CDX	CW ^{+0.05} ₀
TBUR07140010-D050	●	5	7	0.9	4.4	30	14	0.2	1	1
TBUR07190010-D050	●	5	7	0.9	4.4	35	19	0.2	1	1

● : Line up

Solid boring bar for back boring and chamfering

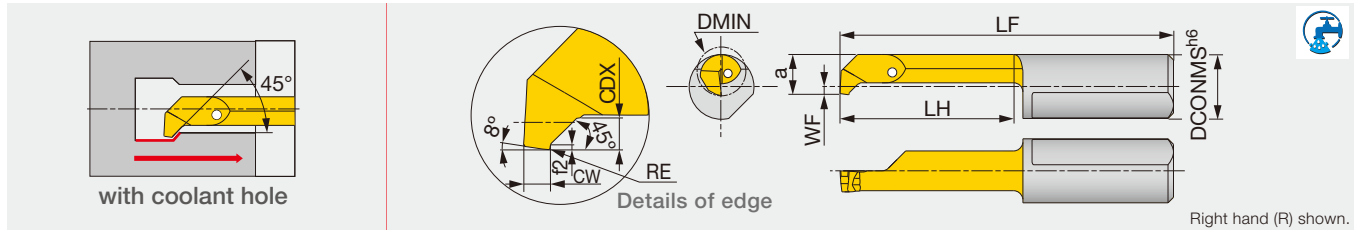

Designation	SH730	DMIN	DCONMS	WF	a	LF	LH	f2	CDX	CW ^{+0.05} ₀	RE
JBUR07140010-D050	●	5	7	0.9	4.4	30	14	0.2	1	1	0.1
JBUR07190010-D050	●	5	7	0.9	4.4	35	19	0.2	1	1	0.1

● : Line up



TBCR

Solid boring bar for boring and 45° chamfering

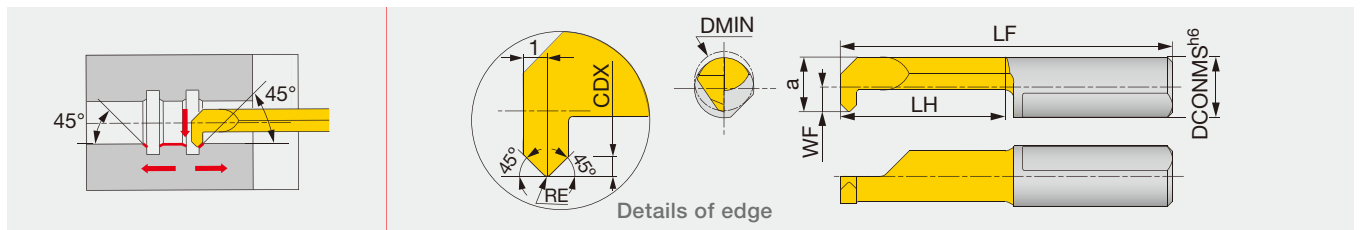

Designation	SH725	DMIN	DCONMS	WF	a	LF	LH	CDX	RE ^{+0.05} ₀
TBCR07140020-D050	●	5	7	0.9	4.4	30	14	0.7	0.2
TBCR07190020-D068	●	6.8	7	2.8	6.3	35	19	0.7	0.2

● : Line up



JBCR

Solid boring bar for boring and 45° chamfering

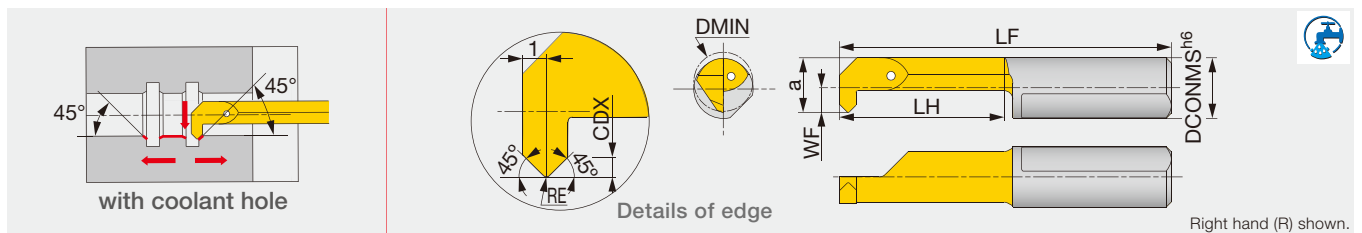

Designation	SH730	DMIN	DCONMS	WF	a	LF	LH	CDX	RE ^{+0.05} ₀
JBCR07140020-D050	●	5	7	0.9	4.4	30	14	0.7	0.2
JBCR07190020-D050	●	5	7	0.9	4.4	35	19	0.7	0.2
JBCR07190020-D068	●	6.8	7	2.8	6.3	35	19	0.7	0.2

● : Line up

TBBR

Solid boring bar for back boring

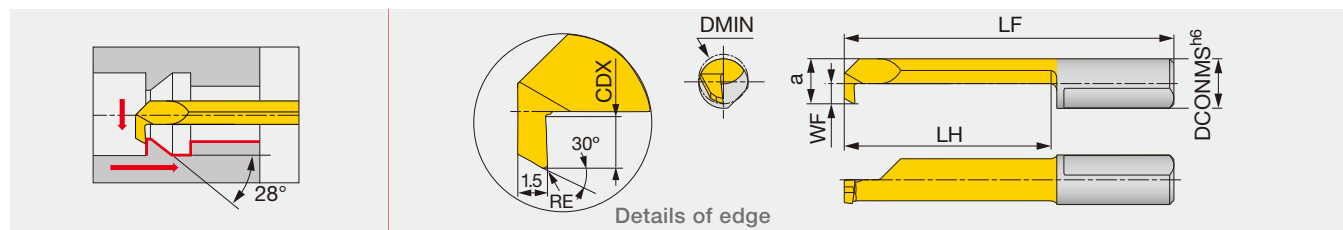

Designation	SH725	DMIN	DCONMS	WF	a	LF	LH	CDX	RE ^{+0.05} ₀
TBBR04140020-D030	●	3	4	0.6	2.6	30	14	0.5	0.2
TBBR04140015-D040	●	4	4	1.5	3.5	30	14	0.8	0.15
TBBR07190020-D050	●	5	7	0.9	4.4	35	19	1	0.2

● : Line up

JBBR

Solid boring bar for back boring

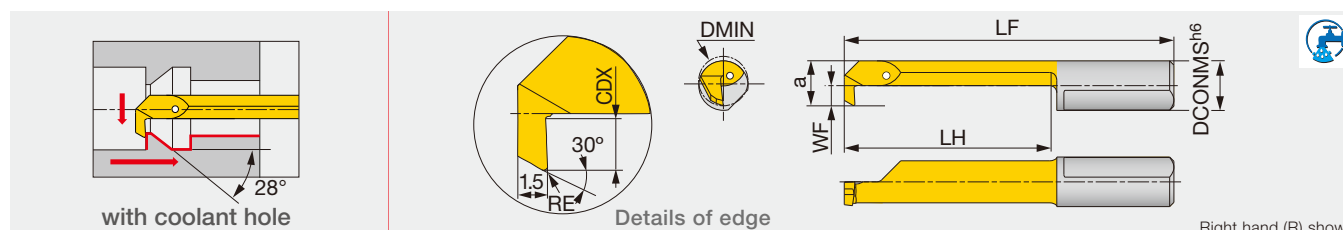

Right hand (R) shown.

Designation	SH730	DMIN	DCONMS	WF	a	LF	LH	CDX	RE ^{+0.05} ₀
JBBR04140020-D030	●	3	4	0.6	2.6	30	14	0.5	0.2
JBBR04190020-D030	●	3	4	0.6	2.6	35	19	0.5	0.2
JBBR04140015-D040	●	4	4	1.5	3.5	30	14	0.8	0.15
JBBR04240015-D040	●	4	4	1.5	3.5	40	24	0.8	0.15
JBBR07190020-D050	●	5	7	0.9	4.4	35	19	1	0.2
JBBR07290020-D050	●	5	7	0.9	4.4	45	29	1	0.2
JBBR07190020-D060	●	6	7	1.8	5.3	35	19	1.8	0.2
JBBR07290020-D060	●	6	7	1.8	5.3	45	29	1.8	0.2
JBBR07190020-D070	●	7	7	2.8	6.3	35	19	2.5	0.2
JBBR07290020-D070	●	7	7	2.8	6.3	45	29	2.5	0.2

● : Line up

TBIR

Solid boring bar for threading (metric)

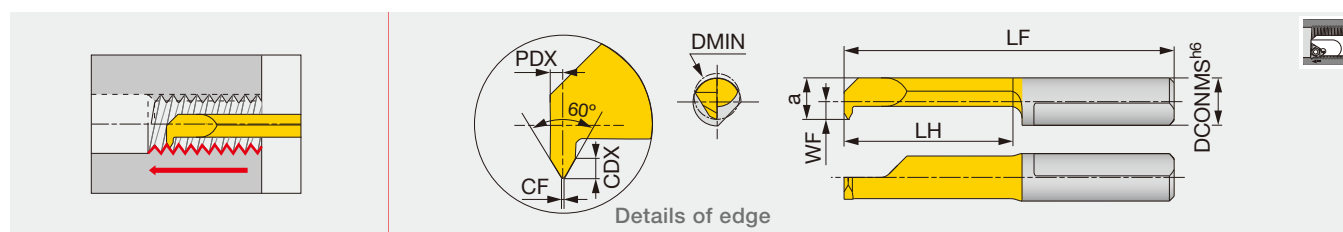

Designation	SH725	Pitch	DMIN	CF ⁰ _{-0.02}	DCONMS	WF	a	LF	LH	CDX	PDX
TBIR04140050-D040	●	0.5	4	0.06	4	1.5	3.5	30	14	0.3	0.35
TBIR07140050-D050	●	0.5	5	0.06	7	0.9	4.4	30	14	0.3	0.35
TBIR07140075-D050	●	0.75	5	0.09	7	0.9	4.4	30	14	0.4	0.45
TBIR07140100-D048	●	1	4.8	0.12	7	0.9	4.4	30	14	0.6	0.55
TBIR07140100-D060	●	1	6	0.12	7	1.8	5.3	30	14	0.6	0.55
TBIR07140150-D060	●	1.5	6	0.18	7	1.8	5.3	30	14	0.8	0.75

● : Line up

Reference pages : TBBR, JBBR, TBIR: Standard cutting conditions → **G109**

Solid boring bar for threading (metric)

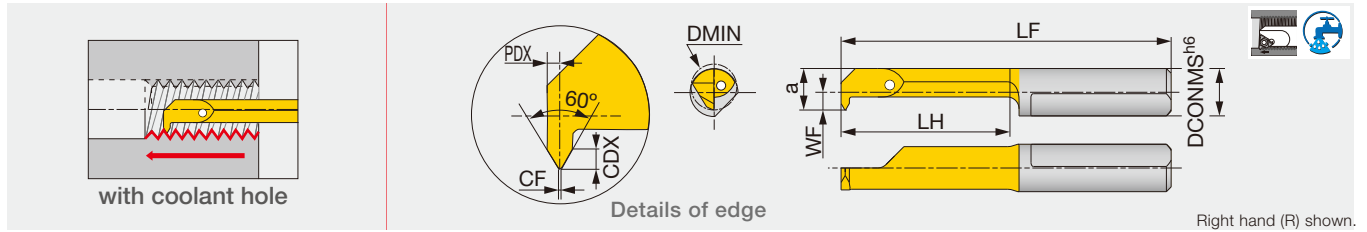

Right hand (R) shown.

Designation	SH730	Pitch	DMIN	CF _{0.02}	DCONMS	WF	a	LF	LH	CDX	PDX
JBIR04140050-D040	●	0.5	4	0.06	4	1.5	3.5	30	14	0.3	0.35
JBIR07140050-D050	●	0.5	5	0.06	7	0.9	4.4	30	14	0.3	0.35
JBIR07140075-D050	●	0.75	5	0.09	7	0.9	4.4	30	14	0.4	0.45
JBIR07140100-D048	●	1	4.8	0.12	7	0.9	4.4	30	14	0.6	0.55
JBIR07140100-D060	●	1	6	0.12	7	1.8	5.3	30	14	0.6	0.55
JBIR07140125-D060	●	1.25	6	0.15	7	1.8	5.3	30	14	0.7	0.65
JBIR07140150-D060	●	1.5	6	0.18	7	1.8	5.3	30	14	0.8	0.75
JBIR07140150-D070	●	1.5	7	0.18	7	2.8	6.3	30	14	0.8	0.75

● : Line up



TBGR

Solid boring bar for internal grooving

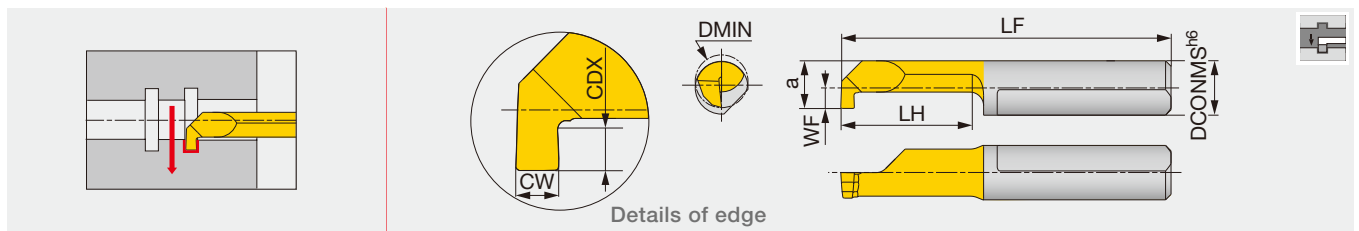

Designation	SH725	CW ^{+0.05} ₀	DMIN	DCONMS	WF	a	LF	LH	CDX
TBGR04100050-D020	●	0.5	2	4	-0.2	1.8	26	10	0.4
TBGR04090100-D040	●	1	4	4	1.5	3.5	25.5	9	0.8
TBGR04150100-D040	●	1	4	4	1.5	3.5	31.5	15	0.8
TBGR07090200-D050	●	2	5	7	0.9	4.4	25	9	1
TBGR07090100-D060	●	1	6	7	1.8	5.3	25	9	1.8
TBGR07140100-D060	●	1	6	7	1.8	5.3	30	14	1.8
TBGR07090150-D060	●	1.5	6	7	1.8	5.3	25	9	1.8
TBGR07090200-D060	●	2	6	7	1.8	5.3	25	9	1.8
TBGR07140200-D060	●	2	6	7	1.8	5.3	30	14	1.8
TBGR07090100-D068	●	1	6.8	7	2.7	6.2	25	9	2.5
TBGR07090150-D068	●	1.5	6.8	7	2.7	6.2	25	9	2.5
TBGR07140150-D068	●	1.5	6.8	7	2.7	6.2	30	14	2.5
TBGR07090200-D068	●	2	6.8	7	2.7	6.2	25	9	2.5
TBGR07140200-D068	●	2	6.8	7	2.7	6.2	30	14	2.5
TBGR07210200-D068	●	2	6.8	7	2.7	6.2	37	21	2.5
TBGR07290200-D068	●	2	6.8	7	2.7	6.2	45	29	2.5

Corner radius : less than 0.1 mm.

● : Line up

JBGR/L

Solid boring bar for internal grooving

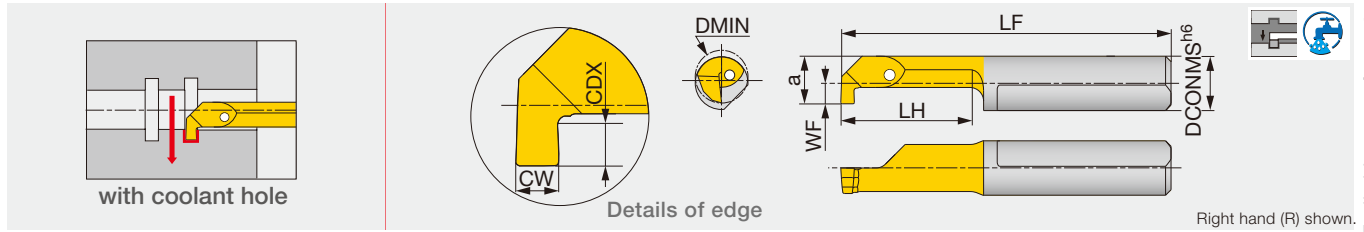

Designation	SH730	CW ^{+0.05} ₀	DMIN	DCONMS	WF	a	LF	LH	CDX
JBGR04050050-D020	●	0.5	2	4	0.2	1.8	21	5	0.4
JBGR04100050-D020	●	0.5	2	4	0.2	1.8	26	10	0.4
JBGR04050070-D030	●	0.7	3	4	0.7	2.7	21	5	0.6
JBGR04100070-D030	●	0.7	3	4	0.7	2.7	26	10	0.6
JBGR04090100-D040	●	1	4	4	1.5	3.5	25.5	9	0.8
JBGR04150100-D040	●	1	4	4	1.5	3.5	31.5	15	0.8
JBGR07090100-D050	●	1	5	7	0.9	4.4	25	9	1
JBGR07140100-D050	●	1	5	7	0.9	4.4	30	14	1
JBGR07090150-D050	●	1.5	5	7	0.9	4.4	25	9	1
JBGR07140150-D050	●	1.5	5	7	0.9	4.4	30	14	1
JBGR07090200-D050	●	2	5	7	0.9	4.4	25	9	1
JBGR07190200-D050	●	2	5	7	0.9	4.4	35	19	1
JBGR/L07090100-D060	●	1	6	7	1.8	5.3	25	9	1.8
JBGR07140100-D060	●	1	6	7	1.8	5.3	30	14	1.8
JBGR07210100-D060	●	1	6	7	1.8	5.3	37	21	1.8
JBGR07290100-D060	●	1	6	7	1.8	5.3	45	29	1.8
JBGR/L07090150-D060	●	1.5	6	7	1.8	5.3	25	9	1.8
JBGR07140150-D060	●	1.5	6	7	1.8	5.3	30	14	1.8
JBGR07210150-D060	●	1.5	6	7	1.8	5.3	37	21	1.8
JBGR07240150-D060	●	1.5	6	7	1.8	5.3	40	24	1.8
JBGR07290150-D060	●	1.5	6	7	1.8	5.3	45	29	1.8
JBGR07090200-D060	●	2	6	7	1.8	5.3	25	9	1.8
JBGR07140200-D060	●	2	6	7	1.8	5.3	30	14	1.8
JBGR07210200-D060	●	2	6	7	1.8	5.3	37	21	1.8
JBGR07240200-D060	●	2	6	7	1.8	5.3	40	24	1.8
JBGR07290200-D060	●	2	6	7	1.8	5.3	45	29	1.8
JBGR07090100-D068	●	1	6.8	7	2.7	6.2	25	9	2.5
JBGR07140100-D068	●	1	6.8	7	2.7	6.2	30	14	2.5
JBGR07210100-D068	●	1	6.8	7	2.7	6.2	37	21	2.5
JBGR07090150-D068	●	1.5	6.8	7	2.7	6.2	25	9	2.5
JBGR07140150-D068	●	1.5	6.8	7	2.7	6.2	30	14	2.5
JBGR07210150-D068	●	1.5	6.8	7	2.7	6.2	37	21	2.5
JBGR07290150-D068	●	1.5	6.8	7	2.7	6.2	45	29	2.5
JBGR07090200-D068	●	2	6.8	7	2.7	6.2	25	9	2.5
JBGR/L07140200-D068	●	2	6.8	7	2.7	6.2	30	14	2.5
JBGR07210200-D068	●	2	6.8	7	2.7	6.2	37	21	2.5
JBGR07250200-D068	●	2	6.8	7	2.7	6.2	40	25	2.5
JBGR07290200-D068	●	2	6.8	7	2.7	6.2	45	29	2.5

Corner radius: less than 0.1 mm

● : Line up



Solid boring bar for face grooving

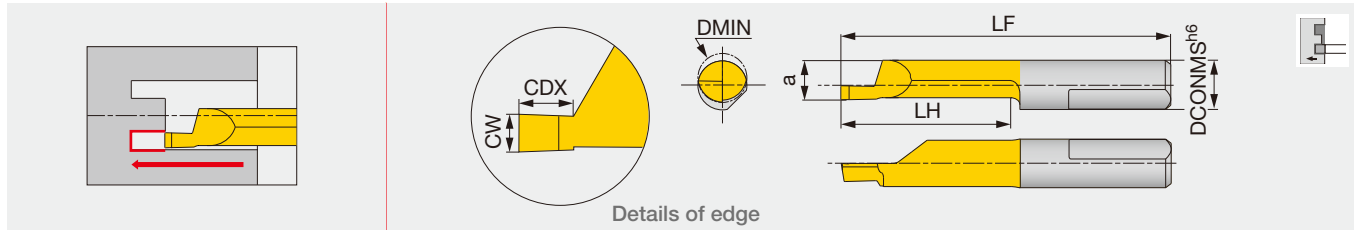

Designation	SH725	CW ^{+0.05} ₀	DMIN	DCONMS	a	LF	LH	CDX
TBFR07110100-D060	●	1	6	7	5.2	26	10	1.5
TBFR07110200-D060	●	2	6	7	5.2	26	10	3
TBFR07110100-D080	●	1	8	7	5.9	27	11	1.5
TBFR07110250-D080	●	2.5	8	7	5.9	27	11	3.5
TBFR07300300-D080	●	3	8	7	5.9	46	30	3.5
TBFR07200250-D150	●	2.5	15	7	5.9	36	20	20
TBFR07200300-D150	●	3	15	7	5.9	36	20	20
TBFR07300300-D150	●	3	15	7	5.9	46	30	30

Corner radius : less than 0.1 mm.

● : Line up



JBFR/L

Solid boring bar for face grooving

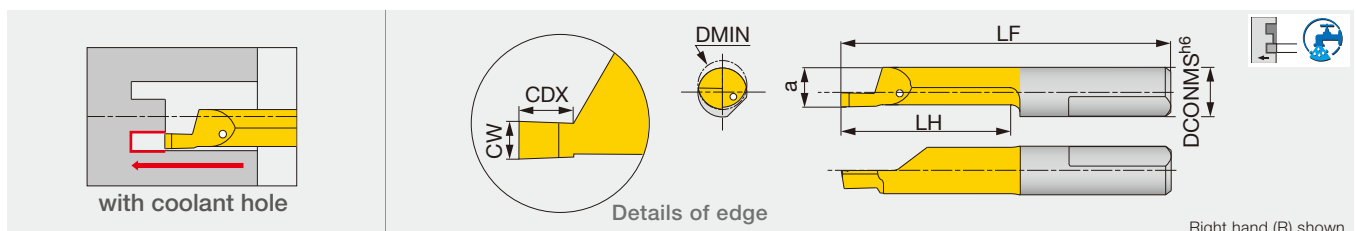

Designation	SH730	CW ^{+0.05} ₀	DMIN	DCONMS	a	LF	LH	CDX
JBFR07110100-D060	●	1	6	7	5.2	26	10	1.5
JBFR07110150-D060	●	1.5	6	7	5.2	26	10	2
JBFR07110200-D060	●	2	6	7	5.2	26	10	3
JBFR07110100-D080	●	1	8	7	5.9	27	11	1.5
JBFR07110150-D080	●	1.5	8	7	5.9	27	11	2.5
JBFR07110200-D080	●	2	8	7	5.9	27	11	3
JBFR07110250-D080	●	2.5	8	7	5.9	27	11	3.5
JBFR07110300-D080	●	3	8	7	5.9	27	11	3.5
JBFR/L07210150-D080	●	1.5	8	7	5.9	36	21	2.5
JBFR07210200-D080	●	2	8	7	5.9	36	21	3
JBFR07210250-D080	●	2.5	8	7	5.9	36	21	3.5
JBFR07210300-D080	●	3	8	7	5.9	36	21	3.5
JBFR/L07300200-D080	●	2	8	7	5.9	46	30	3
JBFR07300300-D080	●	3	8	7	5.9	46	30	3.5
JBFR07200200-D080	●	2	8	7	5.9	36	20	3
JBFR07200250-D150	●	2.5	15	7	5.9	36	20	20
JBFR07200300-D150	●	3	15	7	5.9	36	20	20
JBFR07300300-D150	●	3	15	7	5.9	46	30	30

Corner radius: less than 0.1 mm

● : Line up

Reference pages : TBFR, JBFR/L: Standard cutting conditions → **G109**

TBSR

Solid boring bar for face grooving (for shaft)

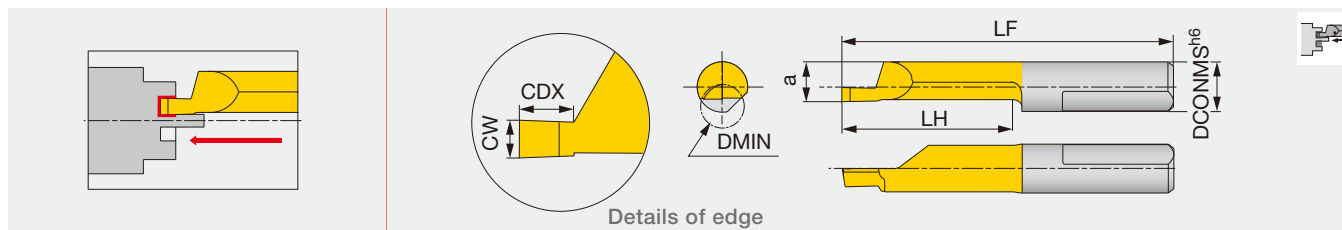

Designation	SH725	$CW^{+0.05}_0$	DMIN	DCONMS	a	LF	LH	CDX
TBSR07200200-D060	●	2	6	7	5.2	36	20	4

Corner radius : less than 0.1 mm.

● : Line up

JBSR

Solid boring bar for face grooving (for shaft)

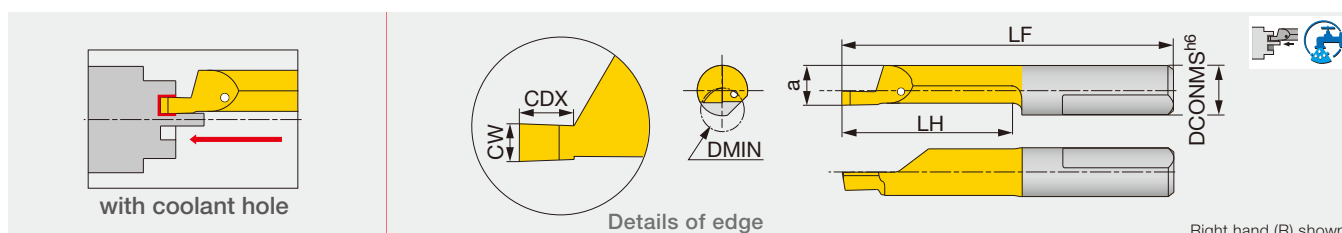

Designation	SH730	$CW^{+0.05}_0$	DMIN	DCONMS	a	LF	LH	CDX
JBSR07200200-D060	●	2	6	7	5.2	36	20	4

Corner radius: less than 0.1 mm

● : Line up

TBRR

Solid boring bar for boring and profiling

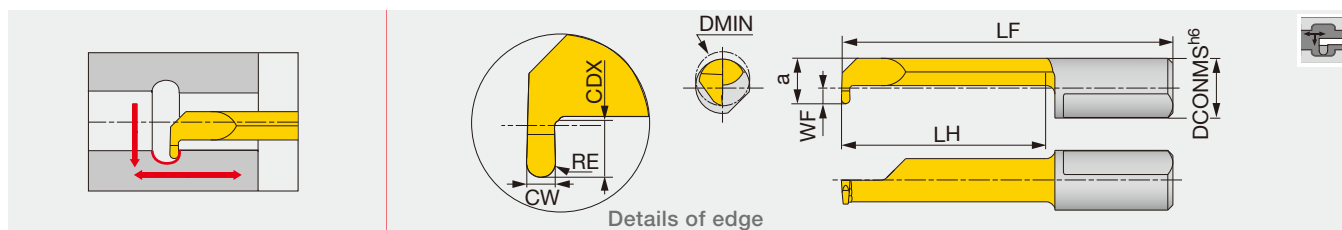

Designation	SH725	$CW^{+0.05}_0$	DMIN	DCONMS	WF	a	LF	LH	CDX	RE
TBRR07190050-D050	●	1	5	7	0.9	4.4	35	19	1	0.5
TBRR07240050-D060	●	1	6	7	1.8	5.3	40	24	1.8	0.5
TBRR07290050-D068	●	1	6.8	7	2.8	6.3	45	29	2.5	0.5

● : Line up

JBRR

Solid boring bar for boring and profiling

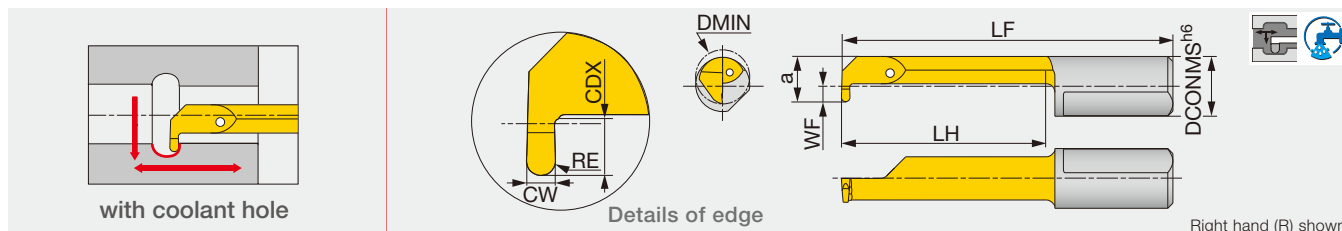

Designation	SH730	$CW^{+0.05}_0$	DMIN	DCONMS	WF	a	LF	LH	CDX	RE
JBRR07190050-D050	●	1	5	7	0.9	4.4	35	19	1	0.5
JBRR07240050-D060	●	1	6	7	1.8	5.3	40	24	1.8	0.5
JBRR07290050-D068	●	1	6.8	7	2.8	6.3	45	29	2.5	0.5

● : Line up

Reference pages : TBSR, JBSR, TBRR, JBRR: Standard cutting conditions → **G109**

Screw-on boring bar, for positive 75° rhombic inserts

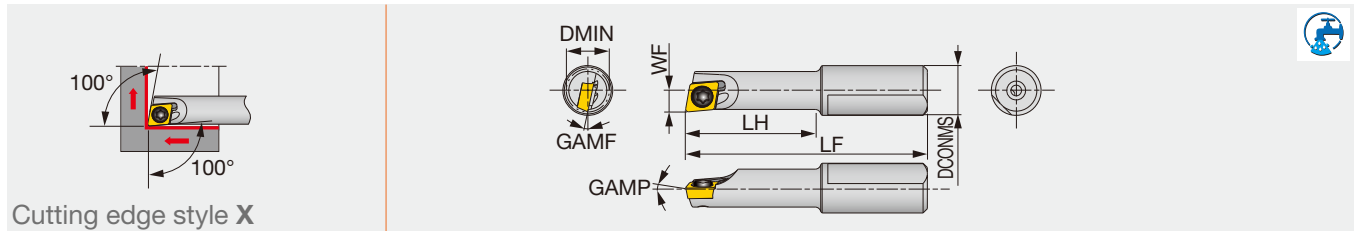

Designation	Material	DMIN	DCONMS	WF	LF	LH	GAMP	GAMF	RE**	Insert	Torque*
A07050-SEXPR03-3	Steel	5	7	2.5	31	15	0°	-13°	0.2	EPGT03X1...	0.6
A07060-SEXPR04-3	Steel	6	7	3.1	34	18	0°	-12°	0.2	EPGT0401...	0.6
E07050-SEXPR03-4	Carbide	5	7	2.5	37	20	0°	-13°	0.2	EPGT03X1...	0.6
E07050-SEXPR03-5	Carbide	5	7	2.5	42	25	0°	-13°	0.2	EPGT03X1...	0.6
E07060-SEXPR04-5	Carbide	6	7	3.1	46	30	0°	-12°	0.2	EPGT0401...	0.6

*Torque: Recommended clamping torque (N·m)
 **RE : Standard corner radius
 Note: Use right-hand toolholders (SEXPR**) with left-hand inserts (L).

A/E-SEZPR

Screw-on boring bar, for positive 75° rhombic inserts

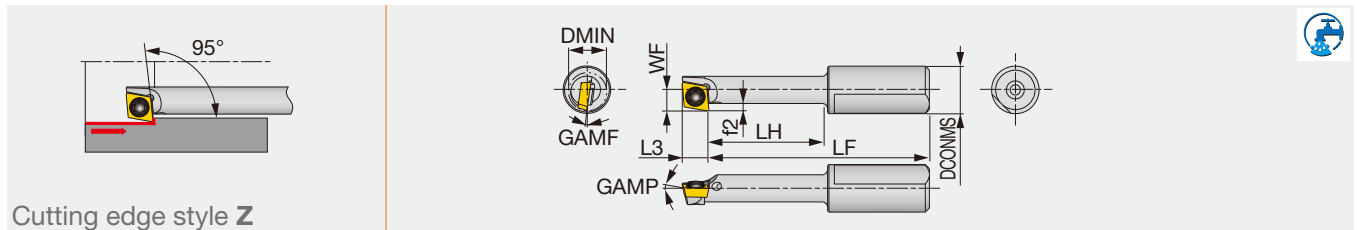

Designation	Material	DMIN	DCONMS	WF	LF	LH	f2	L3	GAMP	GAMF	RE**	Insert	Torque*
A07055-SEZPR03-3	Steel	5.5	7	3.2	32.5	16.5	1.2	3.9	0°	-8°	0.2	EPGT03X1...	0.6
E07055-SEZPR03-5	Carbide	5.5	7	3.2	44.7	27.5	1.2	3.9	0°	-8°	0.2	EPGT03X1...	0.6

*Torque: Recommended clamping torque (N·m)
 **RE : Standard corner radius
 Note: Use right-hand toolholders (SEZPR**) with right-hand inserts (R).

SPARE PARTS

Designation	Clamping screw	Wrench
A/E070**03-...	CSTA-1.6	T-6F
A/E070**04-...	CSTB-2	T-6F

INSERT SELECTION

P	Application	Finishing	M	Application	Finishing	K	Application	Finishing	S	Application	Finishing
	Grade	SH725		Grade	SH725		Grade	SH725		Grade	SH725
	Breaker Shape	JS		Breaker Shape	JS		Breaker Shape	JS		Breaker Shape	JS
	Cutting conditions	B016		Cutting conditions	B018		Cutting conditions	B020		Cutting conditions	B024
N	Application	Precision finishing	Finishing	H	Application	Precision finishing					
	Grade	DX140	SH725		Grade	CBN	BX310				
	Breaker Shape	DIA	JS		Breaker Shape	CBN					
	Cutting conditions	B022			Cutting conditions	B026					

Reference pages: A/E-SEXPR, A/E-SEZPR: Insert → **B128 -**, CBN → **B195**, PCD → **B214**

JBBS-4N

Sleeve for internal coolant supply with 4 coolant holes

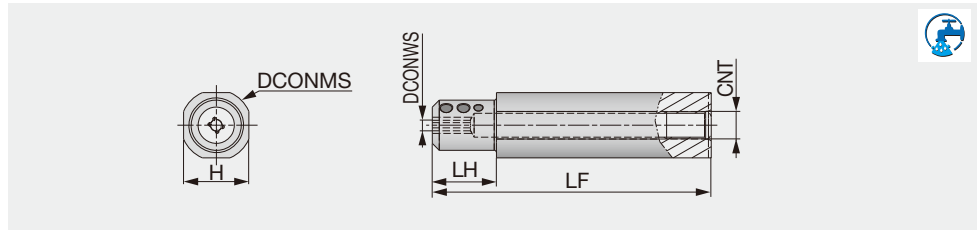

Designation	DCONMS	DCONWS	LF	LH	H	CNT
JBBS12-4-L80C-4N	12	4	80	10	10.3	Rc1/16
JBBS127-4-L80C-4N	12.7	4	80	10	11.6	Rc1/16
JBBS14-4-L80C-4N	14	4	80	10	12	Rc1/8
JBBS159-4-L100C-4N	15.875	4	100	10	14.58	Rc1/8
JBBS159-7-L100C-4N	15.875	7	100	10	14.58	Rc1/8
JBBS16-4-L100C-4N	16	4	100	10	15	Rc1/8
JBBS16-7-L100C-4N	16	7	100	10	15	Rc1/8
JBBS19-4-L100C-4N	19.05	4	100	20	17.2	Rc1/8
JBBS19-7-L100C-4N	19.05	7	100	20	17.2	Rc1/8
JBBS20-4-L100C-4N	20	4	100	20	18	Rc1/8
JBBS20-7-L100C-4N	20	7	100	20	18	Rc1/8
JBBS22-4-L100C-4N	22	4	100	20	20	Rc1/8
JBBS22-7-L100C-4N	22	7	100	20	20	Rc1/8
JBBS25-4-L100C-4N	25	4	100	23	23	Rc1/8
JBBS25-7-L100C-4N	25	7	100	23	23	Rc1/8
JBBS254-4-L100C-4N	25.4	4	100	23	23.4	Rc1/8
JBBS254-7-L100C-4N	25.4	7	100	23	23.4	Rc1/8

JBBS

Sleeve for external coolant supply

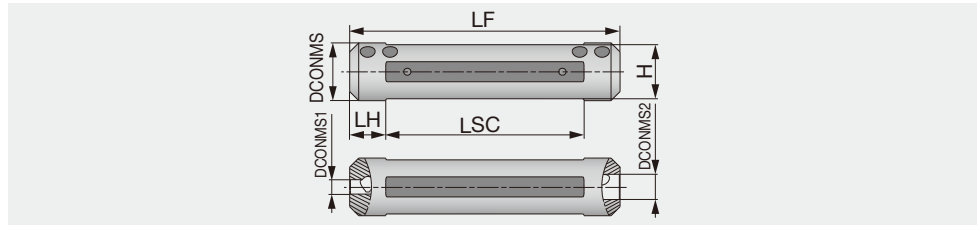

Designation	DCONMS	DCONWS1	DCONWS2	LF	LH	LSC	H
JBBS12-4-4	12	4	4	75	10	55	10.3
JBBS127-4-4	12.7	4	4	76.2	10	56.2	11.6
JBBS14-4-4	14	4	4	75	10	55	12
JBBS159-4-7	15.875	4	7	76.2	10	56.2	14
JBBS16-4-7	16	4	7	75	10	55	15
JBBS19-4-7	19.05	4	7	89	10	69	17.2
JBBS20-4-7	20	4	7	90	10	70	18
JBBS22-4-7	22	4	7	90	10	70	20
JBBS25-4-7	25	4	7	100	10	80	23
JBBS254-4-7	25.4	4	7	90	10	70	23.4

SPARE PARTS



Designation	Clamping screw	Wrench
JBBS**-4-L**C-4N, JBBS127-4-4, JBBS**-4-7	SSHM5-6PF-S	P-2.5
JBBS**-7-L**C-4N, JBBS12-4-4, JBBS14-4-4	SSHM5-4PF-S	P-2.5

Grade
Insert
Ext. Toolholder
Int. Toolholder
Threading
Grooving
Miniature tool
Milling cutter
Endmill
Drilling tool
Tooling System
User's Guide
Index

A
B
C
D
E
F
G
H
I
J
K
L
M

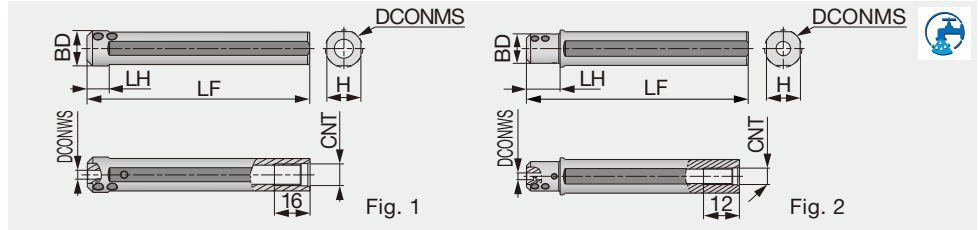

Designation	DCONMS	BD	DCONWS	LF	LH	H	CNT	Fig.
JBBS159-4-L100C	15.875	15.875	4	100	10	14.58	Rc1/8	1
JBBS159-7-L100C	15.875	15.875	7	100	10	14.58	Rc1/8	1
JBBS16-4-L100C	16	16	4	100	10	15	Rc1/8	1
JBBS16-7-L100C	16	16	7	100	10	15	Rc1/8	1
JBBS19-4-L100C	19.05	17.5	4	100	20	17.2	Rc1/8	2
JBBS19-7-L100C	19.05	17.5	7	100	20	17.2	Rc1/8	2
JBBS20-4-L100C	20	17.5	4	100	20	18	Rc1/8	2
JBBS20-7-L100C	20	17.5	7	100	20	18	Rc1/8	2
JBBS22-4-L100C	22	17.5	4	100	20	20	Rc1/8	2
JBBS22-7-L100C	22	17.5	7	100	20	20	Rc1/8	2
JBBS25-4-L100C	25	18	4	100	23	23	Rc1/8	2
JBBS25-7-L100C	25	18	7	100	23	23	Rc1/8	2
JBBS254-4-L100C	25.4	18	4	100	23	23.4	Rc1/8	2
JBBS254-7-L100C	25.4	18	7	100	23	23.4	Rc1/8	2

JBBSA-C

Collet chuck sleeve for solid carbide bars

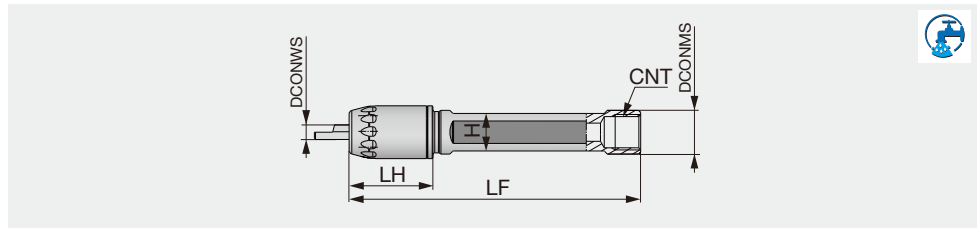

Designation	DCONMS	DCONWS	LF	LH	H	CNT
JBBSA16-4-L100C	16	4	100	23	14	Rc1/8
JBBSA16-7-L100C	16	7	100	23	14	Rc1/8
JBBSA20-4-L120C	20	4	120	23	18	Rc1/8
JBBSA20-7-L120C	20	7	120	23	18	Rc1/8

SPARE PARTS

Designation	Clamping screw	Cap	Wrench	Wrench 1
JBBS**-4-L100C	SSHM5-6PF-S	-	P-2.5	-
JBBS**-7-L100C	SSHM5-4PF-S	-	P-2.5	-
JBBSA**-4-L100C	-	CAP-A-4	-	WRENCH-A-4
JBBSA**-7-L100C	-	CAP-A-7	-	WRENCH-A-7

STANDARD CUTTING CONDITIONS

Boring, profiling, chamfering, back boring

ISO	Workpiece material	Grade	Cutting speed Vc (m/min)	Feed f (mm/rev)	
				Internal grooving	Face grooving
P	Low carbon steels S15C, S25C, etc. C15E, C15E4, etc.	SH730, SH725	40 - 140	0.01 - 0.08	
	Carbon steels, Alloy steels S55C, SCM440, etc. C55, 42CrMo4, etc.	SH730, SH725	40 - 140	0.01 - 0.08	
	Prehardened steels NAK80, PX5, etc.	SH730, SH725	40 - 140	0.01 - 0.08	
M	Stainless steels SUS304, SUS316, etc. X5CrNi18-9, X5CrNiMo17-12-3, etc.	SH730, SH725	40 - 140	0.01 - 0.08	
K	Grey cast irons FC250, FCD300, etc. GG25, 250, GG30, 300, etc.	SH730, SH725	30 - 100	0.01 - 0.08	
	Ductile cast irons FC450, FCD600, etc. GGG60, 600-3, etc.	SH730, SH725	30 - 100	0.01 - 0.08	
N	Aluminium alloys, Copper alloys Si < 12%	SH730, SH725	90 - 200	0.01 - 0.08	
S	Titanium alloys Ti-6Al-4V, etc.	SH730, SH725	30 - 100	0.01 - 0.08	
	Superalloys Inconel718, etc.	SH730, SH725	30 - 100	0.01 - 0.08	

Threading (metric thread)

ISO	Workpiece material	Grade	Cutting speed Vc (m/min)	Number of passes Pitch (mm)				
				0.5	0.75	1	1.25	1.5
P	Low carbon steels S15C, S25C, etc. C15E, C15E4, etc.	SH730, SH725	40 - 140	6 - 8	8 - 10	10 - 12	12 - 15	15 - 18
	Carbon steels, Alloy steels S55C, SCM440, etc. C55, 42CrMo4, etc.	SH730, SH725	40 - 140	6 - 8	8 - 10	10 - 12	12 - 15	15 - 18
	Prehardened steels NAK80, PX5, etc.	SH730, SH725	40 - 140	6 - 8	8 - 10	10 - 12	12 - 15	15 - 18
M	Stainless steels SUS304, SUS316, etc. X5CrNi18-9, X5CrNiMo17-12-3, etc.	SH730, SH725	40 - 140	8	10	12	15	18
K	Grey cast irons FC250, FCD300, etc. GG25, 250, GG30, 300, etc.	SH730, SH725	30 - 100	7	9	12	14	17
	Ductile cast irons FC450, FCD600, etc. GGG60, 600-3, etc.	SH730, SH725	30 - 100	7	9	12	14	17
N	Aluminium alloys, Copper alloys Si < 12%	SH730, SH725	90 - 200	6	8	10	12	15

Internal and face grooving

ISO	Workpiece material	Grade	Cutting speed Vc (m/min)	Feed: f (mm/rev)	
				Internal grooving	Face grooving
P	Low carbon steels S15C, S25C, etc. C15E, C15E4, etc.	SH730, SH725	40 - 140	0.01 - 0.03	0.01 - 0.05
	Carbon steels, Alloy steels S55C, SCM440, etc. C55, 42CrMo4, etc.	SH730, SH725	40 - 140	0.01 - 0.03	0.01 - 0.05
	Prehardened steels NAK80, PX5, etc.	SH730, SH725	40 - 140	0.01 - 0.03	0.01 - 0.05
M	Stainless steels SUS304, SUS316, etc. X5CrNi18-9, X5CrNiMo17-12-3, etc.	SH730, SH725	40 - 140	0.01 - 0.03	0.01 - 0.05
K	Grey cast irons FC250, FCD300, etc. GG25, 250, GG30, 300, etc.	SH730, SH725	30 - 100	0.01 - 0.03	0.01 - 0.05
	Ductile cast irons FC450, FCD600, etc. GGG60, 600-3, etc.	SH730, SH725	30 - 100	0.01 - 0.03	0.01 - 0.05
N	Aluminium alloys, Copper alloys Si < 12%	SH730, SH725	90 - 200	0.01 - 0.03	0.01 - 0.05
S	Titanium alloys Ti-6Al-4V, etc.	SH730, SH725	30 - 100	0.01 - 0.03	0.01 - 0.05
	Superalloys Inconel718, etc.	SH730, SH725	30 - 100	0.01 - 0.03	0.01 - 0.05

MINI V LOCK GROOVE QC12-SVER/L-CHP

Modular head for external grooving and threading, with high pressure coolant capability

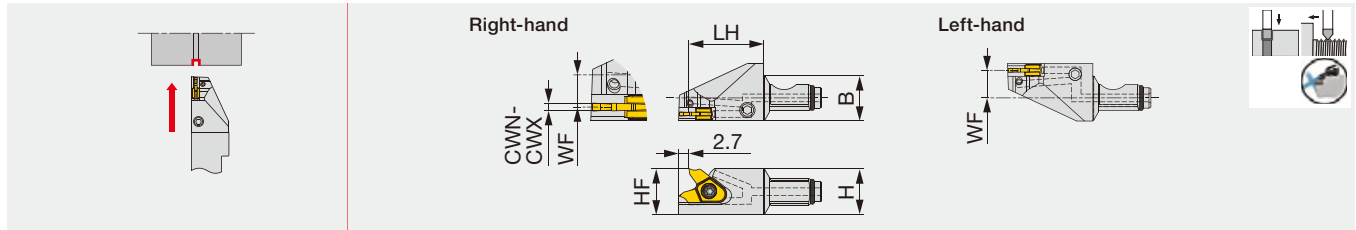

Designation	CWN	CWX	H	B	LH	HF	WF (1)	Insert	Torque*
QC12-SVER/L10-CHP	0.5	1	12	12	19.5	12	4.19/7.19	VG*10...	1.3

Torque*: Recommended clamping torque (N-m)

(1) "WF" indicates the distance from the reference position to the center of the cutting edge width. The first value before "/" indicates the WF for the right-hand holder and the second value after "/" for the left-hand holder.

SVER/L

External grooving and threading toolholder

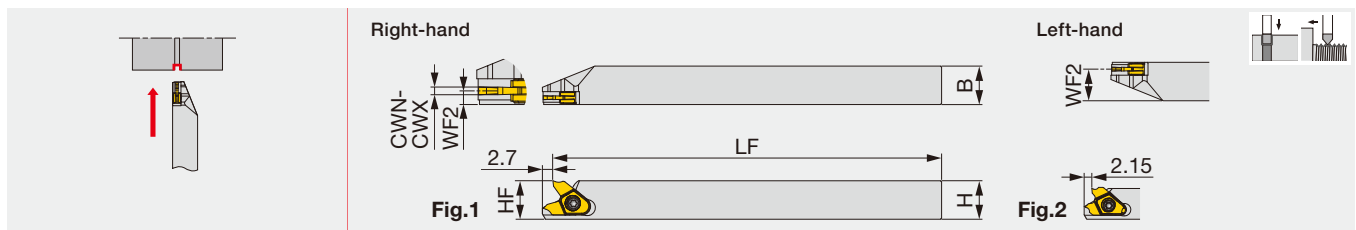

Designation	CWN	CWX	H	B	LF	HF	WF2(1)	Insert	Torque*	Fig.
SVER/L0808H08	0.33	1	8	8	100	8	1.23/6.78	VGP08...	1.1	2
SVER/L1010H10	0.5	1	10	10	100	10	1.78/8.23	VG*10...	1.3	1
SVER/L1212X10	0.5	1	12	12	120	12	1.78/10.23	VG*10...	1.3	1

Torque*: Recommended clamping torque (N-m)

(1) "WF" indicates the distance from the reference position to the center of the cutting edge width. The first value before "/" indicates the WF for the right-hand holder and the second value after "/" for the left-hand holder.

SVER/L-CHP

External grooving and threading toolholder, with high pressure coolant capability

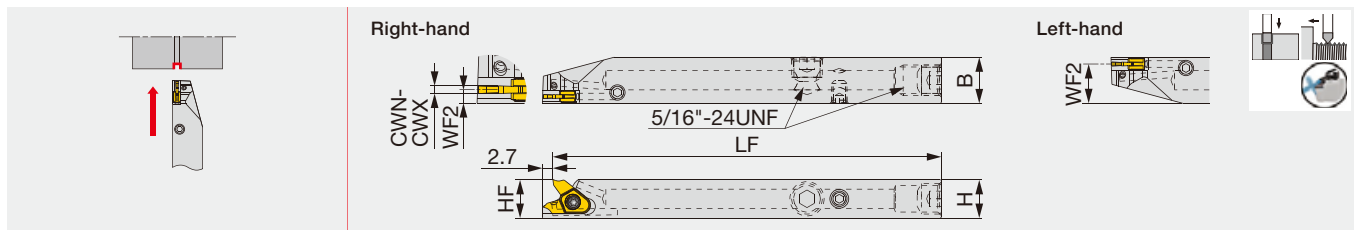

Designation	CWN	CWX	H	B	LF	HF	WF2 (1)	Insert	Torque*
SVER/L1012H10-CHP	0.5	1	10	12	100	10	1.78/10.23	VG*10...	1.3
SVER/L1212X10-CHP	0.5	1	12	12	120	12	1.78/10.23	VG*10...	1.3

Compatible to the direct internal coolant supply system without the use of external coolant hose.

Torque*: Recommended clamping torque (N-m)

(1) "WF" indicates the distance from the reference position to the center of the cutting edge width. The first value before "/" indicates the WF for the right-hand holder and the second value after "/" for the left-hand holder.

SPARE PARTS

Designation	Clamping screw	Coolant plug	DirectJet plug	Wrench	Wrench 1	Wrench 2	O-ring
QC12-SVER10-CHP	CSTB-2.5L054DL	-	-	-	-	-	ORSS-0454.5X1.0NBR70
QC12-SVEL10-CHP	CSTB-2.5L054DR	-	-	-	-	-	ORSS-0454.5X1.0NBR70
SVER0808...	CSTB-2.2L053DL	-	-	T-7F	-	-	-
SVEL0808...	CSTB-2.2L053DR	-	-	T-7F	-	-	-
SVER1012/1212...	CSTB-2.5L054DL	SR5/16UNFTL360	SSHM4-6-TB	T-7F	P-4	P-2	-
SVEL1012/1212...	CSTB-2.5L054DR	SR5/16UNFTL360	SSHM4-6-TB	T-7F	P-4	P-2	-

Reference pages : QC12-SVER/L-CHP, SVER/L, SVER/L-CHP:

Shank, accessory → **G095, G096**, Standard cutting condition → **G112**

INSERTS

VGP08/10 (For grooving / sharp edge)

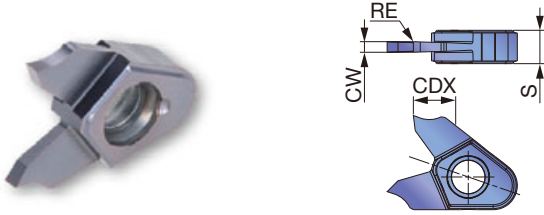

P	Steel	★						
M	Stainless	★						
K	Cast iron							
N	Non-ferrous	★						
S	Superalloys	★						
H	Hard materials							

★ : First choice

Designation	CW±0.025	RE	Coated					CDX*	CUTDIA	S
			SH725							
VGP08-033F-000	0.33	0	●					2	4	2.2
VGP08-050F-000	0.5	0	●					2	4	2.2
VGP08-075F-000	0.75	0	●					2.5	5	2.2
VGP08-100F-000	1	0	●					2.5	5	2.2
VGP10-050F-000	0.5	0	●					2.5	5	3.15
VGP10-050F-005	0.5	0.05	●					2.5	5	3.15
VGP10-075F-000	0.75	0	●					3	6	3.15
VGP10-075F-005	0.75	0.05	●					3	6	3.15
VGP10-100F-000	1	0	●					4	8	3.15
VGP10-100F-005	1	0.05	●					4	8	3.15

*Max grooving depth varies depending on workpiece diameters. See below for details.

● : Line up

Note: Max grooving depths vs workpiece diameters

To avoid tool interference with the workpiece, max grooving depths (T max) for the insert used may be smaller than the CDX values listed above depending on the workpiece diameter.

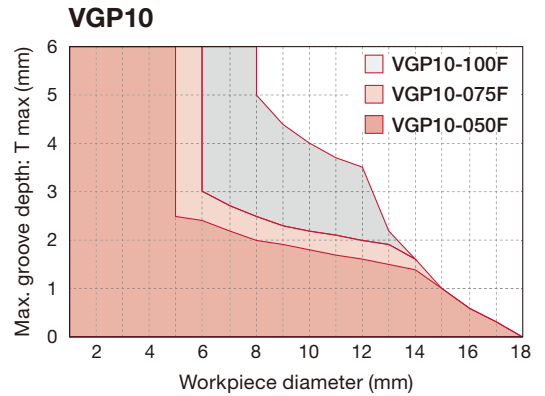
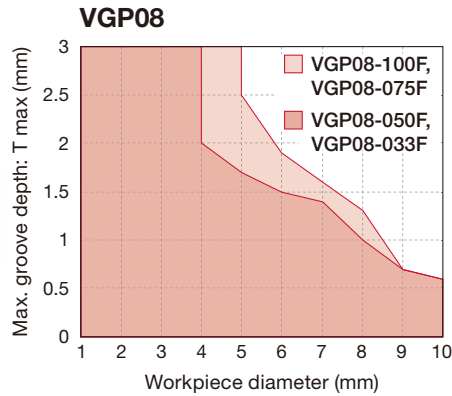
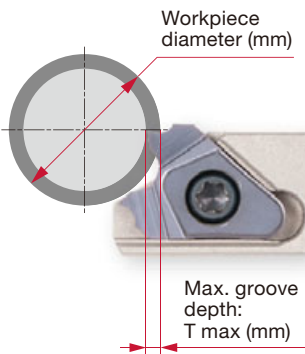

Grade
Insert
Ext. Toolholder
Int. Toolholder
Threading
Grooving
Miniature tool
Milling cutter
Endmill
Drilling tool
Tooling System
User's Guide
Index

A
B
C
D
E
F
G
H
I
J
K
L
M

STANDARD CUTTING CONDITIONS

Grooving

ISO	Workpiece materials	Grade	Cutting speed Vc (m/min)	Feed f (mm/rev)
P	Low carbon steels S15C, SS400, etc. C15E4, E275A, etc.	SH725	50 - 150	0.005 - 0.1
	Carbon steels, Alloy steels S55C, SCM440, etc. C55, 42CrMo4, etc.	SH725	50 - 150	0.005 - 0.1
	Free cutting steels SUH22, SUH23, etc.	SH725	50 - 150	0.005 - 0.1
M	Stainless steels SUS304, X5CrNi18-9, etc.	SH725	50 - 100	0.005 - 0.1
N	Aluminium alloys A5056, A6061, etc.	SH725	150 - 200	0.005 - 0.1
	Copper alloy C2600, C280C, etc.	SH725	100 - 200	0.005 - 0.1
S	Titanium alloys Ti-6Al-4V, etc.	SH725	30 - 80	0.005 - 0.1
	Superalloys Inconel718, etc.	SH725	30 - 80	0.005 - 0.1



External



Internal



Grooving



Threading



Parting-off

Y-axis turning modular head for external grooving and threading

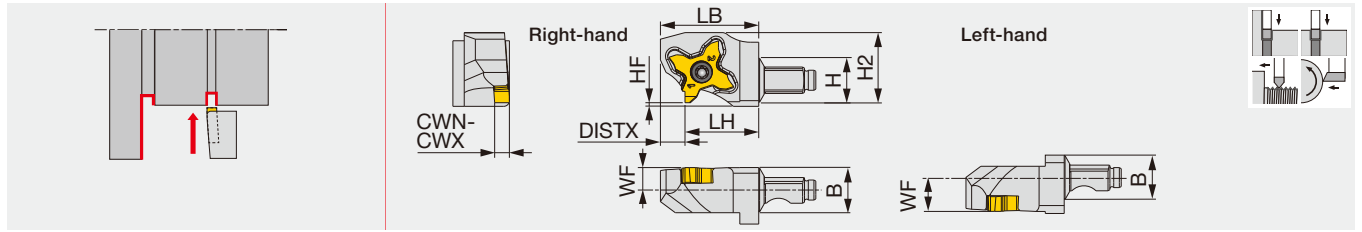

Designation	CWN	CWX	H	B	LH	HF	WF	LB	H2	DISTX	Insert	Torque*
QC12-STCR/L18-Y	0.33	3.18	12	12	19.5	0	6	26	18.6	6.5	TC*18R/L...	1.2

Torque*: Recommended clamping torque (N-m)

The right hand insert (R) is used for the right hand toolholders (R), and the left hand insert (L) is used for the left hand toolholders (L).

QC12-STCR/L-Y-CHP

Y-axis turning modular head for external grooving and threading, with high pressure coolant capability

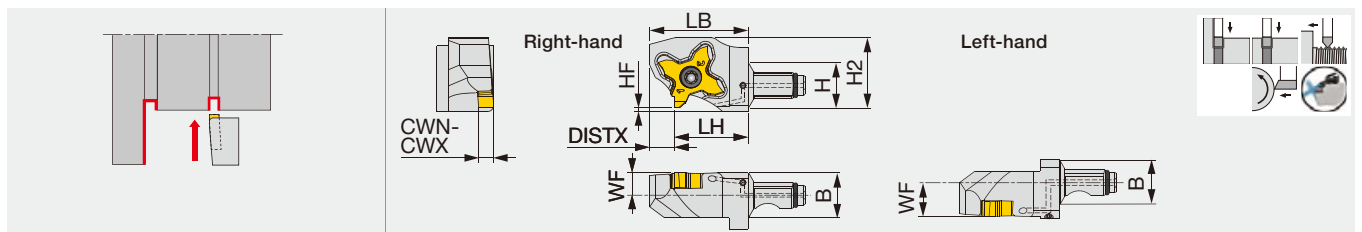

Designation	CWN	CWX	H	B	LH	HF	WF	LB	H2	DISTX	Insert	Torque*
QC12-STCR/L18-Y-CHP	0.33	3.18	12	12	19.5	0	6	26	18.6	6.5	TC*18R/L...	1.2

Torque*: Recommended clamping torque (N-m)

The right hand insert (R) is used for the right hand toolholders (R), and the left hand insert (L) is used for the left hand toolholders (L).

Through-coolant head

SPARE PARTS

Designation	Clamping screw	Wrench	O-ring
QC12-STCR18-Y, QC12-STCR18	CSTC-4L100DL	T-1008/5	-
QC12-STCL18-Y, QC12-STCL18	CSTC-4L100DR	T-1008/5	-
QC12-STCR18-Y-CHP	CSTC-4L100DL	T-1008/5	ORSS-0454.5X1.0NBR70
QC12-STCL18-Y-CHP	CSTC-4L100DR	T-1008/5	ORSS-0454.5X1.0NBR70

TETRAMCUT

QC12-STCR/L

Modular head for external grooving and threading

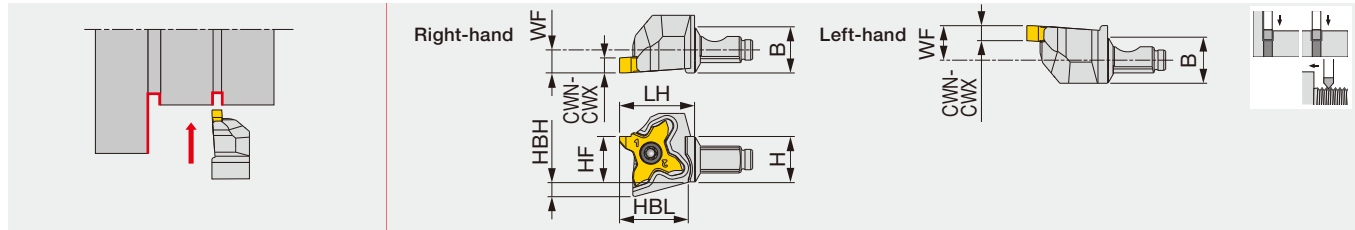

Designation	CWN	CWX	H	B	LH	HF	HBH	HBL	WF	Insert	Torque*
QC12-STCR18	0.33	3.18	12	12	19.5	12	3.9	17.9	6	TC*18R...	1.2
QC12-STCL18	0.33	3.18	12	12	21	12	3.9	18.3	9	TC*18L...	1.2

Torque*: Recommended clamping torque (N-m)

The right hand insert (R) is used for the right hand toolholders (R), and the left hand insert (L) is used for the left hand toolholders (L).

QC12-STCR/L-CHP

Modular head for external grooving and threading, with high pressure coolant capability

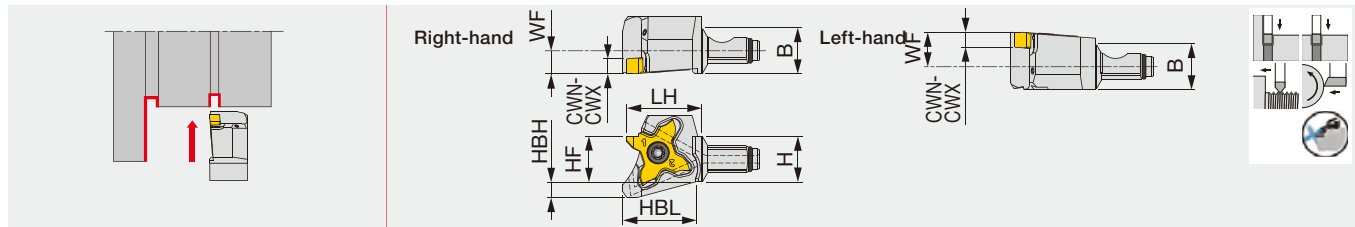

Designation	CWN	CWX	H	B	LH	HF	HBH	HBL	WF	Insert	Torque*
QC12-STCR/L18-CHP	0.33	3.18	12	12	21	12	4.2	19.3	9	TC*18R/L...	1.2

Torque*: Recommended clamping torque (N-m)

The right hand insert (R) is used for the right hand toolholders (R), and the left hand insert (L) is used for the left hand toolholders (L).

SPARE PARTS

Designation	Clamping screw	Wrench	O-ring
QC12-STCR18	CSTC-4L100DL	T-1008/5	-
QC12-STCL18	CSTC-4L100DR	T-1008/5	-
QC12-STCR18-CHP	CSTC-4L100DL	T-1008/5	ORSS-0454.5X1.0NBR70
QC12-STCL18-CHP	CSTC-4L100DR	T-1008/5	ORSS-0454.5X1.0NBR70

Reference pages : QC12-STCR/L, QC12-STCR/L-CHP: Inserts → [G117](#) -
Shank, Accessory → [G095](#), [G096](#), Standard cutting conditions → [G124](#)

STCR/L-18

External grooving and threading toolholder

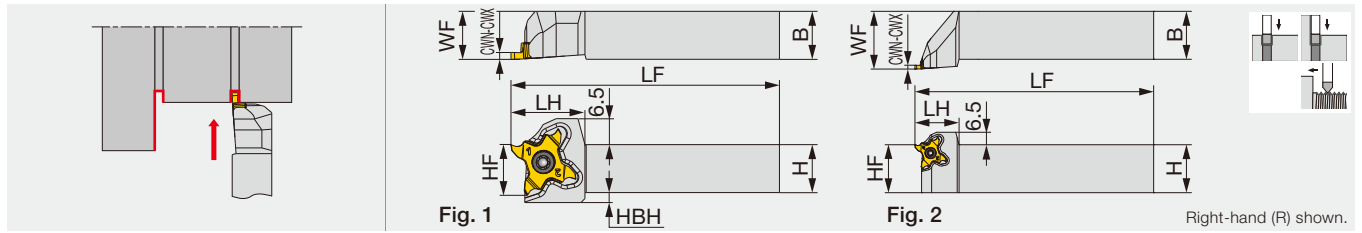

Designation	CWN	CWX	H	B	LF	LH	HF	WF	HBH	Insert	Torque*	Fig.
STCR/L1010X18	0.33	3.18	10	10	120	18.5	10	10	4.5	TC*18...	1.2	1
STCR/L1212F18	0.33	3.18	12	12	85	18.5	12	12	2.5	TC*18...	1.2	1
STCR/L1212X18	0.33	3.18	12	12	120	18.5	12	12	2.5	TC*18...	1.2	1
STCR/L1616X18	0.33	3.18	16	16	120	18.5	16	16	-	TC*18...	1.2	1
STCR/L2020H18	0.33	3.18	20	20	100	18.5	20	20	-	TC*18...	1.2	1
STCR/L2020X18	0.33	3.18	20	20	120	23	20	25	-	TC*18...	1.2	2

The right hand insert (TC*18R...) is used for the right hand toolholders (STCR...), and the left hand insert is used for the left hand toolholders
 *Torque: Recommended clamping torque: N·m

STCR/L-H/X18-CHP

Direct connection

External grooving and threading toolholder, with high pressure coolant capability

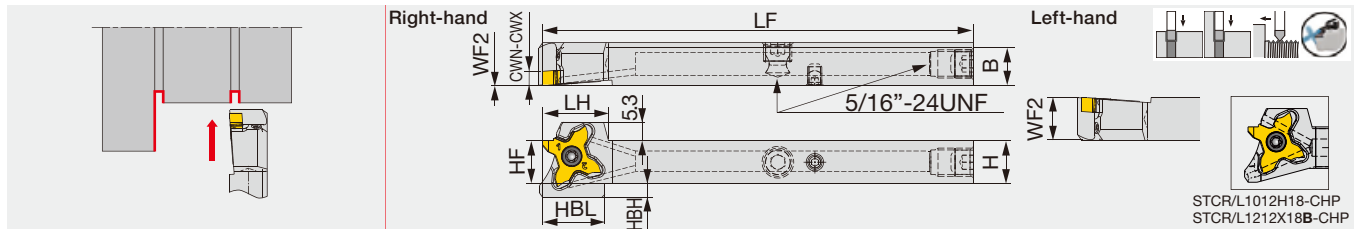

Designation	CWN	CWX	H	B	LF	LH	HBL	HF	WF2	HBH	Insert	Torque*
STCR/L1012H18-CHP	0.33	3.18	10	12	100	17.1	17.1	10	0/12	4	TC**18	1.2
STCR/L1212X18B-CHP	0.33	3.18	12	12	120	18.5	17.5	12	0/12	4	TC**18	1.2
STCR/L1616X18-CHP	0.33	3.18	16	16	120	18.5	-	16	0/16	0	TC**18	1.2

The right hand insert (TC*18R...) is used for the right hand toolholders (STCR...), and the left hand insert (TC*18L...) is used for the left hand toolholders (STCL...)
 *Torque: Recommended torque (N·m) for clamping

SPARE PARTS

Designation	Clamping screw	Wrench	Coolant plug	Wrench	DirectJet plug	Wrench
STCR**18	CSTC-4L100DL	T-1008/5	-	-	-	-
STCL**18	CSTC-4L100DR	T-1008/5	-	-	-	-
STCL**18-CHP	CSTC-4L100DR	T-1008/5	SR5/16UNFTL360	P-4	SSHM4-6-TB	P-2
STCR**18-CHP	CSTC-4L100DL	T-1008/5	SR5/16UNFTL360	P-4	SSHM4-6-TB	P-2

Threading pitch range: 0.8 - 3.0 mm

Grade
Insert
Ext. Toolholder
Int. Toolholder
Threading
Grooving
Miniature tool
Milling cutter
Endmill
Drilling tool
Tooling System
User's Guide
Index

A
B
C
D
E
F
G
H
I
J
K
L
M

External grooving and threading toolholder, with high pressure coolant capability

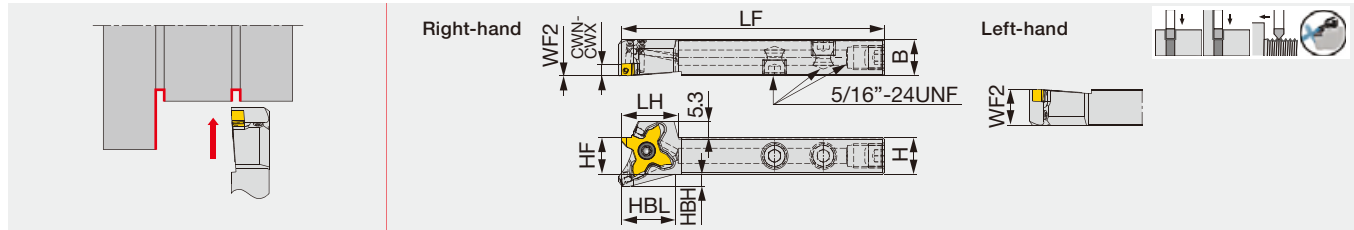

Designation	CWN	CWX	H	B	LF	LH	HBL	HF	WF2 ⁽¹⁾	HBH	Insert	Torque*
STCR/L1212F18B-CHP	0.33	3.18	12	12	85	18.5	17.5	12	0/12	4	TC**18	1.2

The right hand insert (TC*18R**) is used for the right hand toolholders (STCR**), and the left hand insert (TC*18L**) is used for the left hand toolholders (STCL**).
 (1) *0/12" for the WF dimension indicates WF = 0 for the right handed tool, WF = 12 for the left handed tool.
 *Torque: Recommended torque (N-m) for clamping

JS-STCL18

External grooving and threading toolholder with round shank, for Swiss lathes

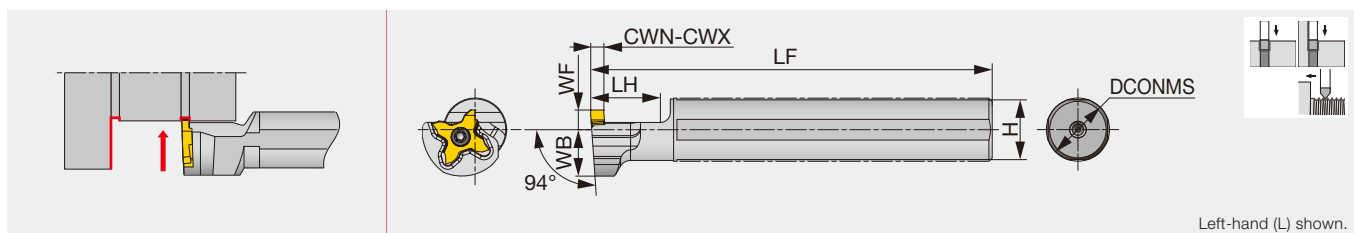

Designation	CWN	CWX	DCONMS	LF	LH	H	WB	WF	Insert	Torque*
JS14H-STCL18	0.33	3.18	14	100	20	13	14	6	TC*18R...	1.2
JS159F-STCL18	0.33	3.18	15.875	85	20	15	14	6	TC*18R...	1.2
JS16F-STCL18	0.33	3.18	16	85	20	15	14	6	TC*18R...	1.2
JS19G-STCL18	0.33	3.18	19.05	90	20	18	14	6	TC*18R...	1.2
JS19X-STCL18	0.33	3.18	19.05	120	20	18	14	6	TC*18R...	1.2
JS20G-STCL18	0.33	3.18	20	90	20	19	14	6	TC*18R...	1.2
JS20X-STCL18	0.33	3.18	20	120	20	19	14	6	TC*18R...	1.2
JS22X-STCL18	0.33	3.18	22	120	20	21	12.25	10	TC*18R...	1.2
JS25H-STCL18	0.33	3.18	25	100	20	24	12.25	10	TC*18R...	1.2
JS254X-STCL18	0.33	3.18	25.4	120	20	24	12.25	10	TC*18R...	1.2

The left hand toolholder (STCL...) is used with the right hand inserts (TC*18R...)
 *Torque: Recommended clamping torque: N-m

SPARE PARTS

Designation	Clamping screw	Wrench	Coolant plug	Wrench
STCL**F18B-CHP	CSTC-4L100DR	T-1008/5	SR5/16UNFTL360	P-4
STCR**F18B-CHP	CSTC-4L100DL	T-1008/5	SR5/16UNFTL360	P-4
JS...STCL18	CSTC-4L100DL	T-1008/5	-	-

Threading pitch range: 0.8 - 3.0 mm

Selection guide for TetraMini-Cut inserts

Groove width CW (mm)	Corner rad. RE (mm)	TCL18R/L (G118 page)	TCS18R/L (G118 page -)	TCG18R/L (G120 page -)	TCP18R/L (G122 page)	TCP18R/L-F (G123 page)
		AH7025	AH7025	AH7025	AH725	SH725
0.33	0.05				●	●
0.43	0.05				●	●
0.50	0.05				●	●
0.75	0.05				●	●
0.95	0.05				●	●
1.00	0.05					●
	0.1		●	●	●	●
1.20	0.5			●		
	0.05					●
1.25	0.1		●	●	●	●
	0.2		●	●	●	●
1.30	0.2		●	●		
1.40	0.1		●	●	●	●
	0.2		●	●		
1.45	0.05					●
	0.1		●	●	●	●
	0.2			●		
1.50	0.05					●
	0.1	●	●	●	●	●
	0.2	●	●	●		
1.58	0.79			●		
1.60	0.2		●	●		
1.70	0.2		●	●		
1.75	0.05					●
	0.1		●	●	●	●
	0.2	●	●	●		
1.85	0.2		●	●		
1.95	0.2		●	●		
2.00	0.05					●
	0.1	●	●	●	●	●
	0.2	●	●	●		
2.25	1.0			●		
	0.2		●	●		
2.30	0.2		●	●		
2.39	1.2			●		
2.50	0.1		●	●	●	●
	0.2		●	●		
	0.3	●	●	●		
2.65	0.3		●	●		
2.80	0.3		●	●		
3.00	0.1	●	●	●	●	●
	0.2	●	●	●		
	0.3	●	●	●		
	1.5			●		
3.18	1.59			●		

● : Line up

Grade
Insert
Ext. Toolholder
Int. Toolholder
Threading
Grooving
Miniature tool
Milling cutter
Endmill
Drilling tool
Tooling System
User's Guide
Index

A
B
C
D
E
F
G
H
I
J
K
L
M

INSERT

TCL18R/L (3D chipbreaker, honed edge)

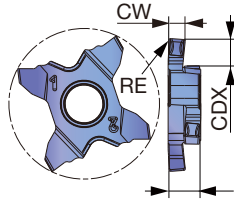

Right-hand (R) shown.

P	Steel	★								
M	Stainless	★								
K	Cast iron	★								
N	Non-ferrous									
S	Superalloys	★								
H	Hard materials									

★ : First choice

Designation	HAND	CW±0.02	RE	Coated							CDX	
				AH7025								
TCL18R150-010	R	1.5	0.1	●								3.5
TCL18L150-010	L	1.5	0.1	●								3.5
TCL18R150-020	R	1.5	0.2	●								3.5
TCL18L150-020	L	1.5	0.2	●								3.5
TCL18R175-020	R	1.75	0.2	●								3.5
TCL18L175-020	L	1.75	0.2	●								3.5
TCL18R200-010	R	2	0.1	●								3.5
TCL18L200-010	L	2	0.1	●								3.5
TCL18R200-020	R	2	0.2	●								3.5
TCL18L200-020	L	2	0.2	●								3.5
TCL18R250-030	R	2.5	0.3	●								3.5
TCL18L250-030	L	2.5	0.3	●								3.5
TCL18R300-010	R	3	0.1	●								3.5
TCL18L300-010	L	3	0.1	●								3.5
TCL18R300-020	R	3	0.2	●								3.5
TCL18L300-020	L	3	0.2	●								3.5
TCL18R300-030	R	3	0.3	●								3.5
TCL18L300-030	L	3	0.3	●								3.5

Please see page G125 for precautions of processing.

5 pieces per package

● : Line up

TCS18R (honed edge) (3D chipbreaker, honed edge)

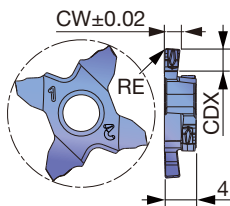

P	Steel	★								
M	Stainless	★								
K	Cast iron	★								
N	Non-ferrous									
S	Superalloys	★								
H	Hard materials									

★ : First choice

☆ : Second choice

Designation	HAND	CW±0.02	RE	Coated							CDX	
				AH7025								
TCS18R100-010	R	1	0.1	●								2
TCS18L100-010	L	1	0.1	●								2
TCS18R120-010	R	1.2	0.1	●								2
TCS18L120-010	L	1.2	0.1	●								2
TCS18R125-010	R	1.25	0.1	●								2
TCS18L125-010	L	1.25	0.1	●								2

Please see page G125 for precautions of processing.

5 pieces per package

● : Line up

P	Steel	★							
M	Stainless	★							
K	Cast iron	★							
N	Non-ferrous								
S	Superalloys	★							
H	Hard materials								

★ : First choice
☆ : Second choice

Designation	HAND	CW±0.02	RE	Coated					CDX
				AH7025					
TCS18R125-020	R	1.25	0.2	●					2
TCS18L125-020	L	1.25	0.2	●					2
TCS18R130-020	R	1.3	0.2	●					3.5
TCS18L130-020	L	1.3	0.2	●					3.5
TCS18R140-010	R	1.4	0.1	●					3.5
TCS18L140-010	L	1.4	0.1	●					3.5
TCS18R140-020	R	1.4	0.2	●					3.5
TCS18L140-020	L	1.4	0.2	●					3.5
TCS18R145-010	R	1.45	0.1	●					3.5
TCS18L145-010	L	1.45	0.1	●					3.5
TCS18R150-010	R	1.5	0.1	●					3.5
TCS18L150-010	L	1.5	0.1	●					3.5
TCS18R150-020	R	1.5	0.2	●					3.5
TCS18L150-020	L	1.5	0.2	●					3.5
TCS18R160-020	R	1.6	0.2	●					3.5
TCS18L160-020	L	1.6	0.2	●					3.5
TCS18R170-020	R	1.7	0.2	●					3.5
TCS18L170-020	L	1.7	0.2	●					3.5
TCS18R175-010	R	1.75	0.1	●					3.5
TCS18L175-010	L	1.75	0.1	●					3.5
TCS18R175-020	R	1.75	0.2	●					3.5
TCS18L175-020	L	1.75	0.2	●					3.5
TCS18R185-020	R	1.85	0.2	●					3.5
TCS18L185-020	L	1.85	0.2	●					3.5
TCS18R195-020	R	1.95	0.2	●					3.5
TCS18L195-020	L	1.95	0.2	●					3.5
TCS18R200-010	R	2	0.1	●					3.5
TCS18L200-010	L	2	0.1	●					3.5
TCS18R200-020	R	2	0.2	●					3.5
TCS18L200-020	L	2	0.2	●					3.5
TCS18R225-020	R	2.25	0.2	●					3.5
TCS18L225-020	L	2.25	0.2	●					3.5
TCS18R230-020	R	2.3	0.2	●					3.5
TCS18L230-020	L	2.3	0.2	●					3.5
TCS18R250-010	R	2.5	0.1	●					3.5
TCS18L250-010	L	2.5	0.1	●					3.5
TCS18R250-020	R	2.5	0.2	●					3.5
TCS18L250-020	L	2.5	0.2	●					3.5
TCS18R250-030	R	2.5	0.3	●					3.5
TCS18L250-030	L	2.5	0.3	●					3.5
TCS18R265-030	R	2.65	0.3	●					3.5
TCS18L265-030	L	2.65	0.3	●					3.5
TCS18R280-030	R	2.8	0.3	●					3.5
TCS18L280-030	L	2.8	0.3	●					3.5
TCS18R300-010	R	3	0.1	●					3.5
TCS18L300-010	L	3	0.1	●					3.5
TCS18R300-020	R	3	0.2	●					3.5
TCS18L300-020	L	3	0.2	●					3.5
TCS18R300-030	R	3	0.3	●					3.5
TCS18L300-030	L	3	0.3	●					3.5

Please see page G125 for precautions of processing.

5 pieces per package

● : Line up

Reference pages : Toolholders → G113 - G116, Standard cutting conditions → G124

Grade
Insert
Ext. Toolholder
Int. Toolholder
Threading
Grooving
Miniature tool
Milling cutter
Endmill
Drilling tool
Tooling System
User's Guide
Index



INSERT

TCG18R/L (honed edge)

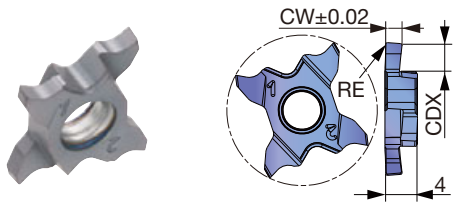

P	Steel	★
M	Stainless	★
K	Cast iron	★
N	Non-ferrous	
S	Superalloys	★
H	Hard materials	

★ : First choice
☆ : Second choice

Designation	HAND	CW±0.02	RE	Coated		CDX
				AH7025		
TCG18R100-010	R	1	0.1	●		2
TCG18L100-010	L	1	0.1	●		2
TCG18R120-010	R	1.2	0.1	●		2
TCG18L120-010	L	1.2	0.1	●		2
TCG18R125-010	R	1.25	0.1	●		2
TCG18L125-010	L	1.25	0.1	●		2
TCG18R125-020	R	1.25	0.2	●		2
TCG18L125-020	L	1.25	0.2	●		2
TCG18R130-020	R	1.3	0.2	●		2
TCG18L130-020	L	1.3	0.2	●		2
TCG18R140-010	R	1.4	0.1	●		3.5
TCG18L140-010	L	1.4	0.1	●		3.5
TCG18R140-020	R	1.4	0.2	●		3.5
TCG18L140-020	L	1.4	0.2	●		3.5
TCG18R145-010	R	1.45	0.1	●		3.5
TCG18L145-010	L	1.45	0.1	●		3.5
TCG18R145-020	R	1.45	0.2	●		3.5
TCG18L145-020	L	1.45	0.2	●		3.5
TCG18R150-010	R	1.5	0.1	●		3.5
TCG18L150-010	L	1.5	0.1	●		3.5
TCG18R150-020	R	1.5	0.2	●		3.5
TCG18L150-020	L	1.5	0.2	●		3.5
TCG18R160-020	R	1.6	0.2	●		3.5
TCG18L160-020	L	1.6	0.2	●		3.5
TCG18R170-020	R	1.7	0.2	●		3.5
TCG18L170-020	L	1.7	0.2	●		3.5
TCG18R175-010	R	1.75	0.1	●		3.5
TCG18L175-010	L	1.75	0.1	●		3.5
TCG18R175-020	R	1.75	0.2	●		3.5
TCG18L175-020	L	1.75	0.2	●		3.5
TCG18R185-020	R	1.85	0.2	●		3.5
TCG18L185-020	L	1.85	0.2	●		3.5
TCG18R195-020	R	1.95	0.2	●		3.5
TCG18L195-020	L	1.95	0.2	●		3.5
TCG18R200-010	R	2	0.1	●		3.5
TCG18L200-010	L	2	0.1	●		3.5
TCG18R200-020	R	2	0.2	●		3.5
TCG18L200-020	L	2	0.2	●		3.5
TCG18R225-020	R	2.25	0.2	●		3.5
TCG18L225-020	L	2.25	0.2	●		3.5
TCG18R230-020	R	2.3	0.2	●		3.5
TCG18L230-020	L	2.3	0.2	●		3.5
TCG18R250-010	R	2.5	0.1	●		3.5
TCG18L250-010	L	2.5	0.1	●		3.5

Please see page G125 for precautions of processing.

5 pieces per package

● : Line up

Reference pages : Toolholders → G113 - G116, Standard cutting conditions → G124

P	Steel	★							
M	Stainless	★							
K	Cast iron	★							
N	Non-ferrous								
S	Superalloys	★							
H	Hard materials								

★ : First choice
☆ : Second choice

Designation	HAND	CW±0.02	RE	Coated					CDX
				AH7025					
TCG18R250-020	R	2.5	0.2	●					3.5
TCG18L250-020	L	2.5	0.2	●					3.5
TCG18R250-030	R	2.5	0.3	●					3.5
TCG18L250-030	L	2.5	0.3	●					3.5
TCG18R265-030	R	2.65	0.3	●					3.5
TCG18L265-030	L	2.65	0.3	●					3.5
TCG18R280-030	R	2.8	0.3	●					3.5
TCG18L280-030	L	2.8	0.3	●					3.5
TCG18R300-010	R	3	0.1	●					3.5
TCG18L300-010	L	3	0.1	●					3.5
TCG18R300-020	R	3	0.2	●					3.5
TCG18L300-020	L	3	0.2	●					3.5
TCG18R300-030	R	3	0.3	●					3.5
TCG18L300-030	L	3	0.3	●					3.5

Please see page G125 for precautions of processing.

5 pieces per package

● : Line up

TCG18R/L (Full R, honed edge)

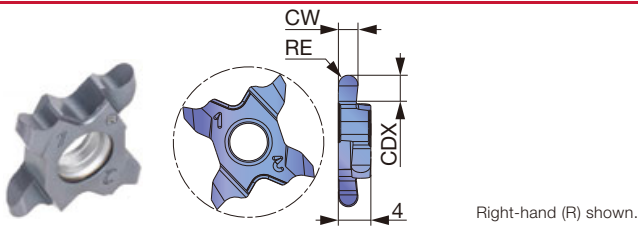

P	Steel	★							
M	Stainless	★							
K	Cast iron	★							
N	Non-ferrous								
S	Superalloys	★							
H	Hard materials								

★ : First choice
☆ : Second choice

Designation	HAND	CW±0.02	RE	Coated					CDX
				AH7025					
TCG18R100-050	R	1	0.5	●					2
TCG18L100-050	L	1	0.5	●					2
TCG18R158-079	R	1.58	0.79	●					3.5
TCG18L158-079	L	1.58	0.79	●					3.5
TCG18R200-100	R	2	1	●					3.5
TCG18L200-100	L	2	1	●					3.5
TCG18R239-120	R	2.39	1.2	●					3.5
TCG18L239-120	L	2.39	1.2	●					3.5
TCG18R300-150	R	3	1.5	●					3.5
TCG18L300-150	L	3	1.5	●					3.5
TCG18R318-159	R	3.18	1.59	●					3.5
TCG18L318-159	L	3.18	1.59	●					3.5

Please see page G125 for precautions of processing.

5 pieces per package

● : Line up

Reference pages : Toolholders → G113 - G116, Standard cutting conditions → G124



INSERT

TCP18R/L (lightly honed edge)

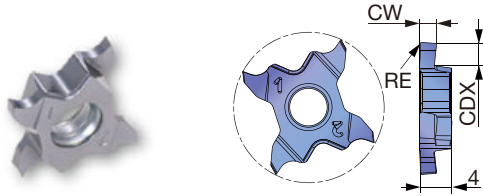

P	Steel	★
M	Stainless	★
K	Cast iron	★
N	Non-ferrous	
S	Superalloys	★
H	Hard materials	

★ : First choice
☆ : Second choice

Designation	HAND	CW±0.02	RE	Coated		CDX
				AH725		
TCP18R033-005	R	0.33	0.05	●		0.8
TCP18L033-005	L	0.33	0.05	●		0.8
TCP18R043-005	R	0.43	0.05	●		1.2
TCP18L043-005	L	0.43	0.05	●		1.2
TCP18R050-005	R	0.50	0.05	●		1.2
TCP18L050-005	L	0.50	0.05	●		1.2
TCP18R075-005	R	0.75	0.05	●		2
TCP18L075-005	L	0.75	0.05	●		2
TCP18R095-005	R	0.95	0.05	●		2
TCP18L095-005	L	0.95	0.05	●		2
TCP18R100-010	R	1	0.1	●		2
TCP18L100-010	L	1	0.1	●		2
TCP18R120-010	R	1.2	0.1	●		2
TCP18L120-010	L	1.2	0.1	●		2
TCP18R125-010	R	1.25	0.1	●		2
TCP18L125-010	L	1.25	0.1	●		2
TCP18R140-010-35	R	1.4	0.1	●		3.5
TCP18L140-010-35	L	1.4	0.1	●		3.5
TCP18R145-010	R	1.45	0.1	●		2
TCP18L145-010	L	1.45	0.1	●		2
TCP18R145-010-35	R	1.45	0.1	●		3.5
TCP18L145-010-35	L	1.45	0.1	●		3.5
TCP18R150-010	R	1.5	0.1	●		2
TCP18L150-010	L	1.5	0.1	●		2
TCP18R150-010-35	R	1.5	0.1	●		3.5
TCP18L150-010-35	L	1.5	0.1	●		3.5
TCP18R175-010	R	1.75	0.1	●		2
TCP18L175-010	L	1.75	0.1	●		2
TCP18R175-010-35	R	1.75	0.1	●		3.5
TCP18L175-010-35	L	1.75	0.1	●		3.5
TCP18R200-010	R	2	0.1	●		2.5
TCP18L200-010	L	2	0.1	●		2.5
TCP18R200-010-35	R	2	0.1	●		3.5
TCP18L200-010-35	L	2	0.1	●		3.5
TCP18R250-010	R	2.5	0.1	●		2.5
TCP18L250-010	L	2.5	0.1	●		2.5
TCP18R250-010-35	R	2.5	0.1	●		3.5
TCP18L250-010-35	L	2.5	0.1	●		3.5
TCP18R300-010	R	3	0.1	●		2.5
TCP18L300-010	L	3	0.1	●		2.5
TCP18R300-010-35	R	3	0.1	●		3.5
TCP18L300-010-35	L	3	0.1	●		3.5

Please see page G125 for precautions of processing.

5 pieces per package

● : Line up

Reference pages : Toolholders → G113 - G116, Standard cutting conditions → G124

TCP18R/L-F (sharp edge)

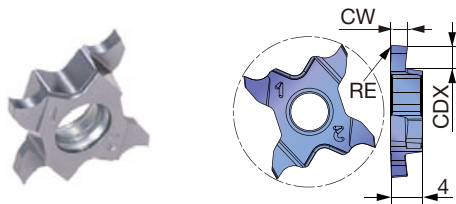

P	Steel	★							
M	Stainless	★							
K	Cast iron	★							
N	Non-ferrous								
S	Superalloys	★							
H	Hard materials								

★ : First choice
☆ : Second choice

Designation	HAND	CW±0.02	RE	Coated						CDX
				SH725						
TCP18R033F-005	R	0.33	0.05	●						0.8
TCP18L033F-005	L	0.33	0.05	●						0.8
TCP18R043F-005	R	0.43	0.05	●						1.2
TCP18L043F-005	L	0.43	0.05	●						1.2
TCP18R050F-005	R	0.5	0.05	●						1.2
TCP18L050F-005	L	0.5	0.05	●						1.2
TCP18R075F-005	R	0.75	0.05	●						2
TCP18L075F-005	L	0.75	0.05	●						2
TCP18R095F-005	R	0.95	0.05	●						2
TCP18L095F-005	L	0.95	0.05	●						2
TCP18R100F-005	R	1	0.05	●						2
TCP18R100F-010	R	1	0.1	●						2
TCP18L100F-010	L	1	0.1	●						2
TCP18R120F-005	R	1.2	0.05	●						2
TCP18R120F-010	R	1.2	0.1	●						2
TCP18L120F-010	L	1.2	0.1	●						2
TCP18R125F-005	R	1.25	0.05	●						2
TCP18R125F-010	R	1.25	0.1	●						2
TCP18L125F-010	L	1.25	0.1	●						2
TCP18R140F-010-35	R	1.4	0.1	●						3.5
TCP18R145F-005-35	R	1.45	0.05	●						3.5
TCP18R145F-010	R	1.45	0.1	●						2
TCP18L145F-010	L	1.45	0.1	●						2
TCP18R145F-010-35	R	1.45	0.1	●						3.5
TCP18L145F-010-35	L	1.45	0.1	●						3.5
TCP18R150F-005-35	R	1.5	0.05	●						3.5
TCP18R150F-010	R	1.5	0.1	●						2
TCP18L150F-010	L	1.5	0.1	●						2
TCP18R150F-010-35	R	1.5	0.1	●						3.5
TCP18L150F-010-35	L	1.5	0.1	●						3.5
TCP18R175F-005-35	R	1.75	0.05	●						3.5
TCP18R175F-010	R	1.75	0.1	●						2
TCP18L175F-010	L	1.75	0.1	●						2
TCP18R175F-010-35	R	1.75	0.1	●						3.5
TCP18L175F-010-35	L	1.75	0.1	●						3.5
TCP18R200F-005-35	R	2	0.05	●						3.5
TCP18R200F-010	R	2	0.1	●						2.5
TCP18L200F-010	L	2	0.1	●						2.5
TCP18R200F-010-35	R	2	0.1	●						3.5
TCP18L200F-010-35	L	2	0.1	●						3.5
TCP18R250F-010	R	2.5	0.1	●						2.5
TCP18L250F-010	L	2.5	0.1	●						2.5
TCP18R250F-010-35	R	2.5	0.1	●						3.5
TCP18L250F-010-35	L	2.5	0.1	●						3.5
TCP18R300F-010	R	3	0.1	●						2.5
TCP18L300F-010	L	3	0.1	●						2.5
TCP18R300F-010-35	R	3	0.1	●						3.5
TCP18L300F-010-35	L	3	0.1	●						3.5

Please see page G125 for precautions of processing.

5 pieces per package

● : Line up

Reference pages : Toolholders → G113 - G116, Standard cutting conditions → G124

Grade
Insert
Ext. Toolholder
Int. Toolholder
Threading
Grooving
Miniature tool
Milling cutter
Endmill
Drilling tool
Tooling System
User's Guide
Index

A
B
C
D
E
F
G
H
I
J
K
L
M

STANDARD CUTTING CONDITIONS

TCS18R (3D chipbreaker) , TCG18R/L (honed edge)

ISO	Workpiece materials	Grades	Cutting speed Vc (m/min)	Feed: f (mm/rev)	
				TCG	TCS
P	Low carbon steel S15C, S20C, etc. C15, C20, etc.	AH7025	80 - 180	0.03 - 0.12	0.03 - 0.15
	Carbon steels, Alloy steel S55C, SCM440, etc. C55, 42CrMoS4, etc.	AH7025	80 - 180	0.03 - 0.12	0.03 - 0.15
	Prehardened steel NAK80, PX5, etc.	AH7025	80 - 180	0.03 - 0.12	0.03 - 0.15
M	Stainless steel SUS304, SUS316, etc. X5CrNi18-9, X5CrNiMo17-12-3, etc.	AH7025	50 - 120	0.03 - 0.12	0.03 - 0.15
K	Grey cast iron FC250, FC300, etc. 250, 300, etc.	AH7025	50 - 180	0.03 - 0.12	0.03 - 0.15
	Ductile cast iron FCD400, FCD600, etc. 400-15, 600-3, etc.	AH7025	50 - 180	0.03 - 0.12	0.03 - 0.15
S	Titanium alloys Ti-6Al-4V, etc.	AH7025	30 - 80	0.03 - 0.12	0.03 - 0.15
	Superalloys Inconel718, etc.	AH7025	20 - 60	0.03 - 0.12	0.03 - 0.15



TCL18R (3D chipbreaker), TCG18R/L (Full R, honed edge)

ISO	Workpiece materials	Grades	Cutting speed Vc (m/min)	Feed: f (mm/rev)	
				TCL18	TCG18
P	Low carbon steel S15C, S20C, etc. C15, C20, etc.	AH7025	80 - 180	0.03 - 0.12	0.04 - 0.14
	Carbon steels, Alloy steel S55C, SCM440, etc. C55, 42CrMoS4, etc.	AH7025	80 - 180	0.03 - 0.12	0.04 - 0.14
	Prehardened steel NAK80, PX5, etc.	AH7025	80 - 180	0.03 - 0.12	0.04 - 0.14
M	Stainless steel SUS304, SUS316, etc. X5CrNi18-9, X5CrNiMo17-12-3, etc.	AH7025	50 - 120	0.03 - 0.12	0.04 - 0.14
K	Grey cast iron FC250, FC300, etc. 250, 300, etc.	AH7025	50 - 180	0.03 - 0.12	0.04 - 0.14
	Ductile cast iron FCD400, FCD600, etc. 400-15, 600-3, etc.	AH7025	50 - 180	0.03 - 0.12	0.04 - 0.14
S	Titanium alloys Ti-6Al-4V, etc.	AH7025	30 - 80	0.03 - 0.12	0.04 - 0.14
	Superalloys Inconel718, etc.	AH7025	20 - 60	0.03 - 0.12	0.04 - 0.14



TCP18R/L (lightly honed edge) / TCP18R/L-F (sharp edge)

ISO	Workpiece materials	Priority	Grades	Cutting speed Vc (m/min)	Feed f (mm/rev)
P	Low carbon steel S15C, S20C, etc. C15, C20, etc.	First choice	SH725	80 - 180	0.03 - 0.1
		Toughness	AH725	80 - 180	0.03 - 0.1
	Carbon steels, Alloy steel S55C, SCM440, etc. C55, 42CrMoS4, etc.	First choice	SH725	80 - 180	0.03 - 0.1
		Toughness	AH725	80 - 180	0.03 - 0.1
	Prehardened steel NAK80, PX5, etc.	First choice	SH725	80 - 180	0.03 - 0.1
		Toughness	AH725	80 - 180	0.03 - 0.1
M	Stainless steel SUS304, SUS316, etc. X5CrNi18-9, X5CrNiMo17-12-3, etc.	First choice	SH725	50 - 120	0.03 - 0.1
		Toughness	AH725	50 - 120	0.03 - 0.1
K	Grey cast iron FC250, FC300, etc. 250, 300, etc.	First choice	AH725	50 - 180	0.03 - 0.1
		Sharpness	SH725	50 - 180	0.03 - 0.1
	Ductile cast iron FCD400, FCD600, etc. 400-15, 600-3, etc.	First choice	AH725	50 - 180	0.03 - 0.1
		Sharpness	SH725	50 - 180	0.03 - 0.1
S	Titanium alloys Ti-6Al-4V, etc.	First choice	SH725	30 - 80	0.03 - 0.1
		Toughness	AH725	30 - 80	0.03 - 0.1
	Superalloys Inconel718, etc.	First choice	SH725	20 - 60	0.03 - 0.1
		Toughness	AH725	20 - 60	0.03 - 0.1

PRECAUTIONS OF PROCESSING

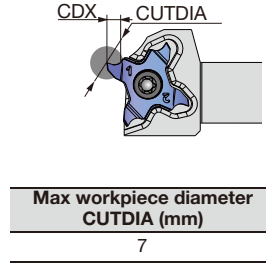
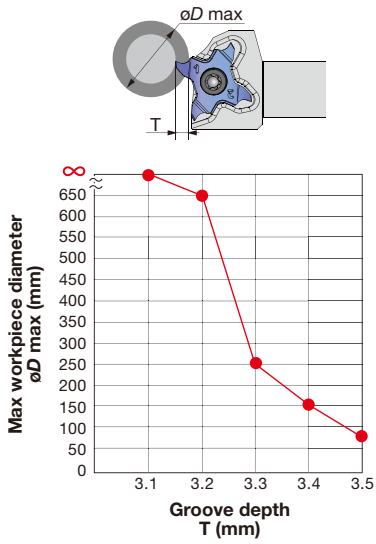

*Groove depth and max workpiece diameter (ϕD_{max})

Maximum workpiece diameter is limited relative to depth of cut in order to avoid collision between insert and workpiece.

Grade	A
Insert	B
Ext. Toolholder	C
Int. Toolholder	D
Threading	E
Grooving	F
Miniature tool	G
Milling cutter	H
Endmill	I
Drilling tool	J
Tooling System	K
User's Guide	L
Index	M

External grooving toolholder

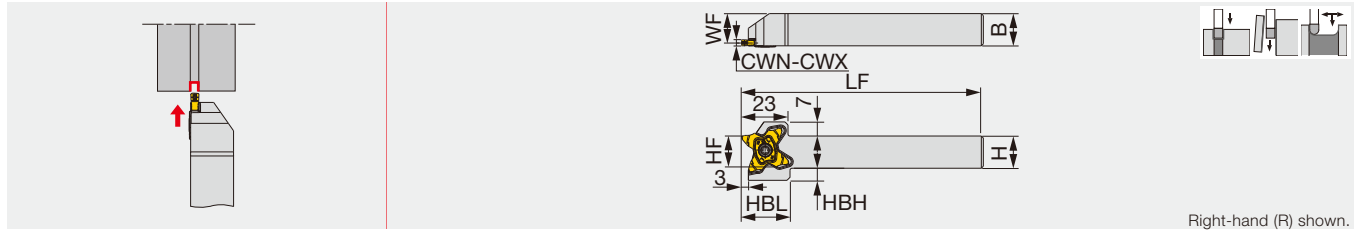

Right-hand (R) shown.

Designation	CWN	CWX	H	B	LF	HF	WF	HBH	HBL	Insert	Torque*
STCR/L1010-27	0.5	3.18	10	10	120	10	8.5	9.5	24	TC*27...	2.5
STCR/L1212-27	0.5	3.18	12	12	120	12	10.5	8	24	TC*27...	2.5
STCR/L1616-27	0.5	3.18	16	16	120	16	14.5	6	24	TC*27...	2.5
STCR/L2020-27	0.5	3.18	20	20	120	20	18.5	2	24	TC*27...	2.5

Torque*: Recommended clamping torque (N-m)



STCR/L1212-27-CHP

Direct connection

Grooving and parting-off toolholder. High pressure coolant capability.

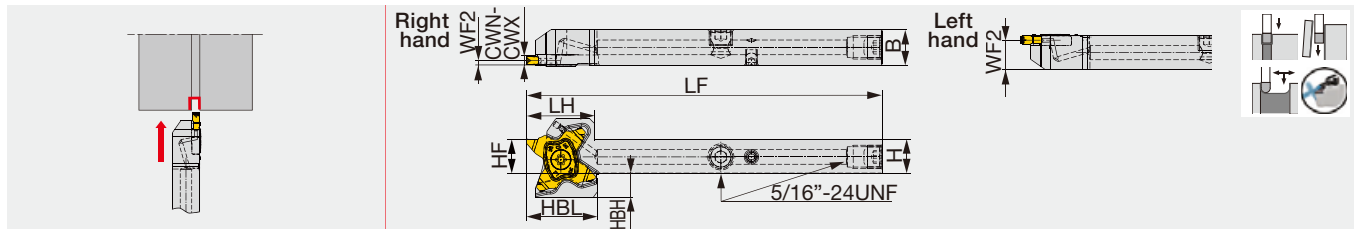

Designation	CWN	CWX	H	B	LF	LH	HF	WF2 ⁽¹⁾	HBH	HBL	Insert	Torque*
STCR/L1212-27-CHP	0.5	3.18	12	12	120	23	12	1.5/10.5	8	24	TC*27...	2.5

(1) The above WF value is valid when an insert width of CW=3 is mounted.

*Torque: Recommended torque (N-m) for clamping

Make sure to avoid tool interferences when used on Swiss machines

STCR/L2020-27-CHP

Tube connection

External grooving and parthing-off toolholder with high pressure coolant supply

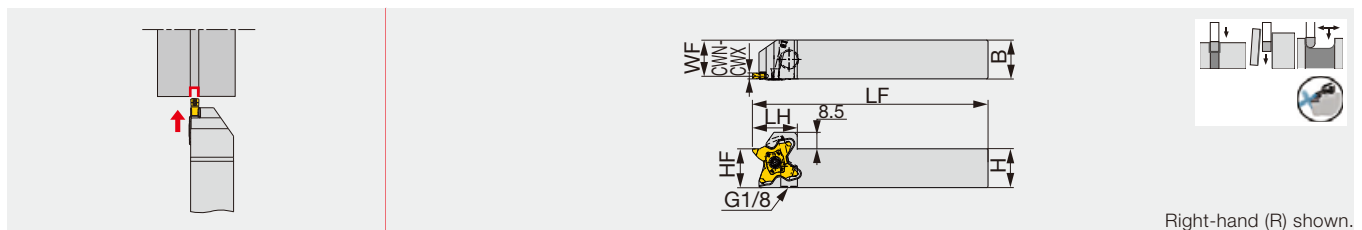

Right-hand (R) shown.

Designation	CWN	CWX	H	B	LF	LH	HF	WF	Insert	Torque*
STCR/L2020-27-CHP	0.5	3.18	20	20	120	23	20	18.5	TC*27...	2.5

Torque*: Recommended clamping torque (N-m)

SPARE PARTS

Designation	Screw	Wrench
STCR****-27, STCR...-27-CHP	SR16-212-01397L	T-2010/5
STCL****-27, STCL...-27-CHP	SR16-212-01397	T-2010/5

Reference pages : STCR/L-27, STCR/L1212-27-CHP, STCR/L2020-27-CHP:

Inserts → **G125 - G131**, Standard cutting conditions → **G131**

INSERT - FOR GROOVING AND PARTING OFF

TCL27

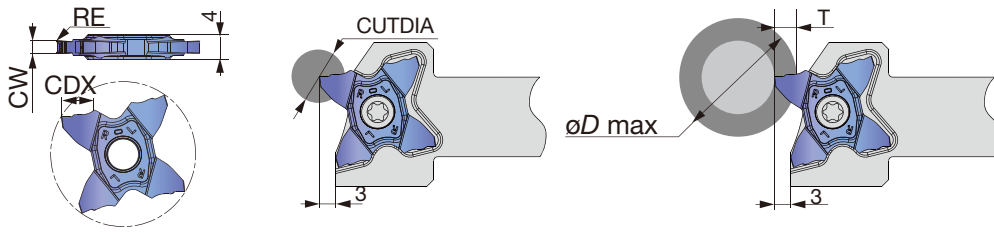

P	Steel	★	
M	Stainless	★	
K	Cast iron	★	
N	Non-ferrous		
S	Superalloys	★	
H	Hard materials		

★ : First choice
☆ : Second choice

Designation	CW±0.02	RE	Coated		CDX	CUTDIA	Relation of groove depth (T) and Max. diameter (øD max)									
			AH725				T ≤ 3	T ≤ 3.5	T ≤ 4	T ≤ 4.5	T ≤ 5	T ≤ 5.5	T ≤ 5.7	T ≤ 6	T ≤ 6.2	T ≤ 6.4
							●	☆	∞	600	280	180	130	50	35	-
TCL27-150-015	1.5	0.15	●	☆	5.7	11.4	∞	600	280	180	130	50	35	-	-	-
TCL27-200-020	2	0.2	●	☆	6.4	12.8	∞	600	280	180	130	105	85	60	50	30
TCL27-250-020	2.5	0.2	●	☆	6.4	12.8	∞	600	280	180	130	105	85	60	50	30
TCL27-300-020	3	0.2	●	☆	6.4	12.8	∞	600	280	180	135	105	95	85	78	55

5 pieces per package

● : Line up

HOW TO INDEX INSERTS

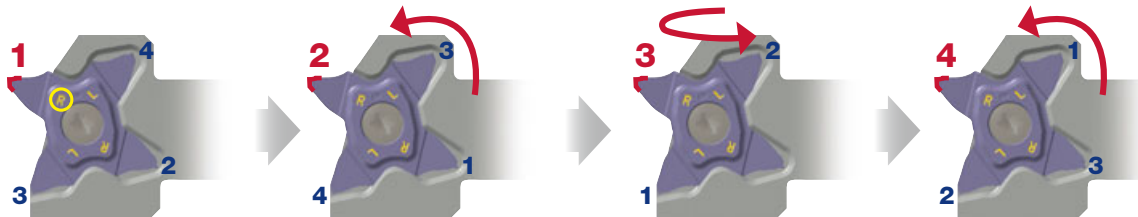

1. Right-hand edge (R) is used for the right-hand toolholders.

2. Rotate the insert

3. Flip over the insert

4. Rotate the insert

Grade
Insert
Ext. Toolholder
Int. Toolholder
Threading
Grooving
Miniature tool
Milling cutter
Endmill
Drilling tool
Tooling System
User's Guide
Index

A
B
C
D
E
F
G
H
I
J
K
L
M

INSERT - FOR GROOVING AND PARTING OFF

TCS27

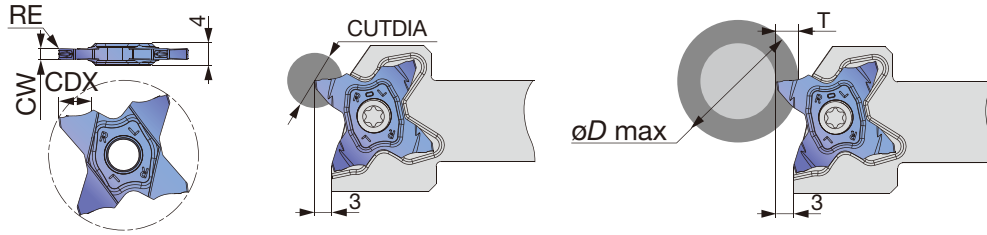

P	Steel	★	
M	Stainless	★	
K	Cast iron	★	
N	Non-ferrous		
S	Superalloys	★	
H	Hard materials		

★ : First choice
☆ : Second choice

Designation	CW±0.02	RE	Coated		CDX	CUTDIA	Relation of groove depth (T) and Max. diameter (øD max)												
			AH725				T≤1	T≤2	T≤3	T≤3.5	T≤4	T≤4.5	T≤5	T≤5.5	T≤5.7	T≤6	T≤6.2	T≤6.4	
TCS27-050-000	0.5	0	●		1	2	∞	-	-	-	-	-	-	-	-	-	-	-	-
TCS27-050-004	0.5	0.04	●		2.5	5	∞	∞	-	-	-	-	-	-	-	-	-	-	-
TCS27-075-010	0.75	0.1	●		2.5	5	∞	∞	-	-	-	-	-	-	-	-	-	-	-
TCS27-080-000	0.8	0	●		1.6	3.2	∞	-	-	-	-	-	-	-	-	-	-	-	-
TCS27-100-006	1	0.06	●		3.5	7	∞	∞	∞	600	-	-	-	-	-	-	-	-	-
TCS27-100-010	1	0.1	●		3.5	7	∞	∞	∞	600	-	-	-	-	-	-	-	-	-
TCS27-104-000	1.04	0	●		2	4	∞	∞	-	-	-	-	-	-	-	-	-	-	-
TCS27-120-000	1.2	0	●		2	4	∞	∞	-	-	-	-	-	-	-	-	-	-	-
TCS27-125-010	1.25	0.1	●		3.5	7	∞	∞	∞	600	-	-	-	-	-	-	-	-	-
TCS27-125-020	1.25	0.2	●		3.5	7	∞	∞	∞	600	-	-	-	-	-	-	-	-	-
TCS27-140-000	1.4	0	●		2	4	∞	∞	-	-	-	-	-	-	-	-	-	-	-
TCS27-147-000	1.47	0	●		2.5	5	∞	∞	-	-	-	-	-	-	-	-	-	-	-
TCS27-150-010	1.5	0.1	●		5.7	11.4	∞	∞	∞	600	280	180	130	50	35	-	-	-	-
TCS27-150-020	1.5	0.2	●		5.7	11.4	∞	∞	∞	600	280	180	130	50	35	-	-	-	-
TCS27-157-015	1.57	0.15	●		3	6	∞	∞	∞	-	-	-	-	-	-	-	-	-	-
TCS27-170-010	1.7	0.1	●		3	6	∞	∞	∞	-	-	-	-	-	-	-	-	-	-
TCS27-175-010	1.75	0.1	●		3	6	∞	∞	∞	-	-	-	-	-	-	-	-	-	-
TCS27-175-020	1.75	0.2	●		3	6	∞	∞	∞	-	-	-	-	-	-	-	-	-	-
TCS27-178-018	1.78	0.18	●		3	6	∞	∞	∞	-	-	-	-	-	-	-	-	-	-
TCS27-185-020	1.85	0.2	●		3	6	∞	∞	∞	-	-	-	-	-	-	-	-	-	-
TCS27-196-015	1.96	0.15	●		3	6	∞	∞	∞	-	-	-	-	-	-	-	-	-	-
TCS27-200-010	2	0.1	●		6.4	12.8	∞	∞	∞	600	280	180	130	105	85	60	50	30	
TCS27-200-020	2	0.2	●		6.4	12.8	∞	∞	∞	600	280	180	130	105	85	60	50	30	
TCS27-222-015	2.22	0.15	●		3.5	7	∞	∞	∞	600	-	-	-	-	-	-	-	-	-
TCS27-230-020	2.3	0.2	●		3.5	7	∞	∞	∞	600	-	-	-	-	-	-	-	-	-
TCS27-239-015	2.39	0.15	●		5.7	11.4	∞	∞	∞	600	280	180	130	50	35	-	-	-	-
TCS27-247-020	2.47	0.2	●		5.7	11.4	∞	∞	∞	600	280	180	130	50	35	-	-	-	-
TCS27-250-010	2.5	0.1	●		5.7	11.4	∞	∞	∞	600	280	180	130	50	35	-	-	-	-
TCS27-250-030	2.5	0.3	●		5.7	11.4	∞	∞	∞	600	280	180	130	50	35	-	-	-	-
TCS27-270-010	2.7	0.1	●		6.2	12.4	∞	∞	∞	600	280	180	135	105	95	85	78	-	-
TCS27-287-020	2.87	0.2	●		6.2	12.4	∞	∞	∞	600	280	180	135	105	95	85	78	-	-
TCS27-300-000	3	0	●		6.4	12.8	∞	∞	∞	600	280	180	135	105	95	85	78	55	
TCS27-300-020	3	0.2	●		6.4	12.8	∞	∞	∞	600	280	180	135	105	95	85	78	55	
TCS27-300-030	3	0.3	●		6.4	12.8	∞	∞	∞	600	280	180	135	105	95	85	78	55	
TCS27-300-040	3	0.4	●		6.4	12.8	∞	∞	∞	600	280	180	135	105	95	85	78	55	
TCS27-315-015	3.15	0.15	●		6.4	12.8	∞	∞	∞	600	280	180	135	105	95	85	78	68	
TCS27-318-020	3.18	0.2	●		6.4	12.8	∞	∞	∞	600	280	180	135	105	95	85	78	68	

5 pieces per package
● : Line up

Reference pages : Toolholders → **G126**, Standard cutting conditions → **G131**

INSERT- FOR PARTING OFF

TCS27-R/L

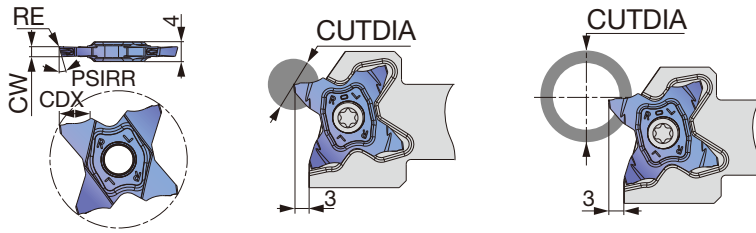

P	Steel	★		
M	Stainless	★		
K	Cast iron	★		
N	Non-ferrous			
S	Superalloys	★		
H	Hard materials			

★ : First choice
☆ : Second choice

Designation	HAND	CW±0.02	RE	Coated		CDX	PSIRL	PSIRR	Max. parting off dia. CUTDIA	
				AH725					Solid bar	Tube
TCS27-100-15R	R	1	0.06	●		3.5	0°	15°	7	600
TCS27-100-15L	L	1	0.06	●		3.5	15°	0°	7	600
TCS27-150-6R	R	1.5	0.06	●		5.7	0°	6°	11.4	35
TCS27-150-6L	L	1.5	0.06	●		5.7	6°	0°	11.4	35
TCS27-150-15R	R	1.5	0.06	●		5.7	0°	15°	11.4	35
TCS27-150-15L	L	1.5	0.06	●		5.7	15°	0°	11.4	35
TCS27-200-6R	R	2	0.1	●		6.4	0°	6°	12.8	30
TCS27-200-6L	L	2	0.1	●		6.4	6°	0°	12.8	30
TCS27-200-15R	R	2	0.1	●		6.4	0°	15°	12.8	30
TCS27-200-15L	L	2	0.1	●		6.4	15°	0°	12.8	30

5 pieces per package

● : Line up

INSERT- FOR GROOVING AND PROFILING

TCS27 (Full R)

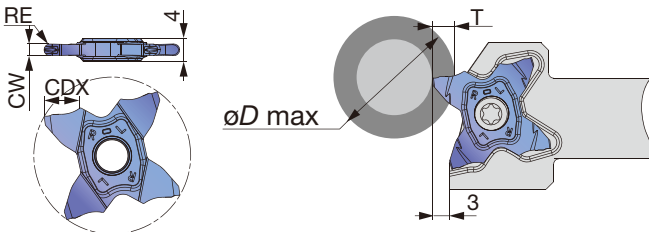

P	Steel	★		
M	Stainless	★		
K	Cast iron	★		
N	Non-ferrous			
S	Superalloys	★		
H	Hard materials			

★ : First choice
☆ : Second choice

Designation	CW±0.02	RE	Coated		CDX	Relation of groove depth (T) and Max. diameter (øD max)										
			AH725			T ≤ 3	T ≤ 3.5	T ≤ 4	T ≤ 4.5	T ≤ 5	T ≤ 5.5	T ≤ 5.7	T ≤ 6	T ≤ 6.2	T ≤ 6.4	
TCS27-157-079	1.57	0.79	●		3	∞	-	-	-	-	-	-	-	-	-	-
TCS27-200-100	2	1	●		3	∞	-	-	-	-	-	-	-	-	-	-
TCS27-239-120	2.39	1.2	●		5.7	∞	600	280	180	130	50	35	-	-	-	-
TCS27-300-150	3	1.5	●		6.4	∞	600	280	180	135	105	95	85	78	55	-

5 pieces per package

● : Line up

Reference pages : Toolholders → **G126**, Standard cutting conditions → **G131**



INSERT- FOR GROOVING AND PARTING OFF

TCM27

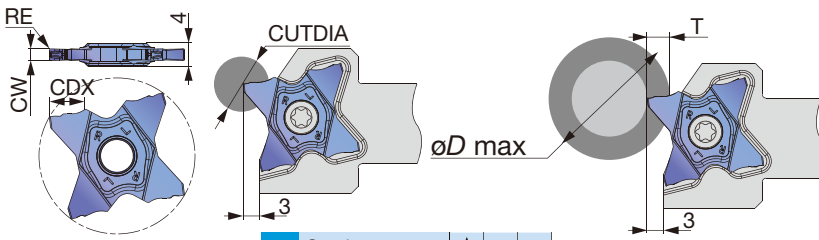

P	Steel	★		
M	Stainless	★		
K	Cast iron	★		
N	Non-ferrous			
S	Superalloys	★		
H	Hard materials			

★ : First choice
☆ : Second choice

Designation	CW±0.02	RE	Coated		CDX	CUTDIA	Relation of groove depth (T) and Max. diameter (øD max)									
			AH725				T ≤ 3	T ≤ 3.5	T ≤ 4	T ≤ 4.5	T ≤ 5	T ≤ 5.5	T ≤ 5.7	T ≤ 6	T ≤ 6.2	T ≤ 6.4
TCM27-150-010	1.5	0.1	●		5.7	11.4	∞	600	280	180	130	50	35	-	-	-
TCM27-150-020	1.5	0.2	●		5.7	11.4	∞	600	280	180	130	50	35	-	-	-
TCM27-157-015	1.57	0.15	●		3	6	∞	-	-	-	-	-	-	-	-	-
TCM27-170-010	1.7	0.1	●		3	6	∞	-	-	-	-	-	-	-	-	-
TCM27-175-010	1.75	0.1	●		3	6	∞	-	-	-	-	-	-	-	-	-
TCM27-175-020	1.75	0.2	●		3	6	∞	-	-	-	-	-	-	-	-	-
TCM27-178-018	1.78	0.18	●		3	6	∞	-	-	-	-	-	-	-	-	-
TCM27-185-020	1.85	0.2	●		3	6	∞	-	-	-	-	-	-	-	-	-
TCM27-196-015	1.96	0.15	●		3	6	∞	-	-	-	-	-	-	-	-	-
TCM27-200-010	2	0.1	●		6.4	12.8	∞	600	280	180	130	105	85	60	50	30
TCM27-200-020	2	0.2	●		6.4	12.8	∞	600	280	180	130	105	85	60	50	30
TCM27-222-015	2.22	0.15	●		3.5	7	∞	600	-	-	-	-	-	-	-	-
TCM27-230-020	2.3	0.2	●		3.5	7	∞	600	-	-	-	-	-	-	-	-
TCM27-239-015	2.39	0.15	●		5.7	11.4	∞	600	280	180	130	50	35	-	-	-
TCM27-247-020	2.47	0.2	●		5.7	11.4	∞	600	280	180	130	50	35	-	-	-
TCM27-250-010	2.5	0.1	●		5.7	11.4	∞	600	280	180	130	50	35	-	-	-
TCM27-250-030	2.5	0.3	●		5.7	11.4	∞	600	280	180	130	50	35	-	-	-
TCM27-270-010	2.7	0.1	●		6.2	12.4	∞	600	280	180	135	105	95	85	78	-
TCM27-287-020	2.87	0.2	●		6.2	12.4	∞	600	280	180	135	105	95	85	78	-
TCM27-300-000	3	0	●		6.4	12.8	∞	600	280	180	135	105	95	85	78	55
TCM27-300-020	3	0.2	●		6.4	12.8	∞	600	280	180	135	105	95	85	78	55
TCM27-300-030	3	0.3	●		6.4	12.8	∞	600	280	180	135	105	95	85	78	55
TCM27-300-040	3	0.4	●		6.4	12.8	∞	600	280	180	135	105	95	85	78	55
TCM27-315-015	3.15	0.15	●		6.4	12.8	∞	600	280	180	135	105	95	85	78	68
TCM27-318-020	3.18	0.02	●		6.4	12.8	∞	600	280	180	135	105	95	85	78	68

5 pieces per package
● : Line up

INSERT - FOR GROOVING AND PROFILING

TCM27 (Full R)

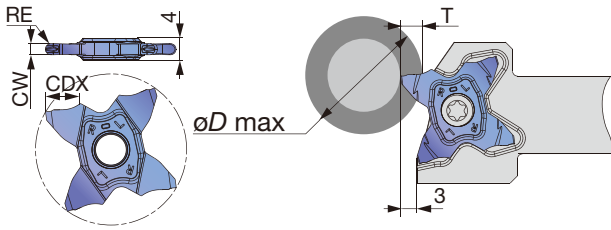

P	Steel	★		
M	Stainless	★		
K	Cast iron	★		
N	Non-ferrous			
S	Superalloys	★		
H	Hard materials			

★ : First choice
☆ : Second choice

Designation	CW±0.02	RE	Coated AH725	CDX	CUTDIA	Relation of groove depth (T) and Max. diameter (øD max)									
						T≤3	T≤3.5	T≤4	T≤4.5	T≤5	T≤5.5	T≤5.7	T≤6	T≤6.2	T≤6.4
						TCM27-157-079	1.57	0.79	●	3	6	∞	-	-	-
TCM27-200-100	2	1	●	3	6	∞	-	-	-	-	-	-	-	-	-
TCM27-239-120	2.39	1.2	●	5.7	11.4	∞	600	280	180	130	50	35	-	-	-
TCM27-300-150	3	0.02	●	6.4	12.8	∞	600	280	180	135	105	95	85	78	55

5 pieces per package

● : Line up

STANDARD CUTTING CONDITIONS

ISO	Workpiece material	Grades	Cutting speed Vc (m/min)	Feed: f (mm/rev)						Depth of cut for profiling (with full radius insert)
				Grooving, parting-off		Parting-off (with hand)		Profiling (with full radius insert)		
				TCL27	TCS27	TCM27	TCS27	TCS27	TCM27	
P	Carbon steel S45C, etc. C45, etc.	AH725	100 - 200	0.03 - 0.12	0.05 - 0.15	0.05 - 0.25	0.04 - 0.12	0.05 - 0.10	0.05 - 0.15	0.5
	Alloy steel SCM435, etc. 34CrMo4, etc.	AH725	50 - 180	0.03 - 0.12	0.05 - 0.15	0.05 - 0.25	0.04 - 0.12	0.05 - 0.10	0.05 - 0.15	0.5
M	Stainless steel SUS304, etc. X5CrNi18-9, etc.	AH725	100 - 150	0.03 - 0.12	0.05 - 0.15	0.05 - 0.20	0.04 - 0.12	0.05 - 0.10	0.05 - 0.15	0.5
K	Grey cast iron FC250, etc. 250, etc.	AH725	50 - 180	0.03 - 0.12	0.05 - 0.15	0.05 - 0.25	0.04 - 0.12	0.05 - 0.10	0.05 - 0.15	0.5
	Ductile cast iron FCD400, etc. 400-15, etc.	AH725	50 - 120	0.03 - 0.12	0.05 - 0.15	0.05 - 0.20	0.04 - 0.12	0.05 - 0.10	0.05 - 0.15	0.5
S	Titanium alloys Ti-6Al-4V, etc.	AH725	30 - 60	0.03 - 0.12	0.05 - 0.15	0.05 - 0.15	0.04 - 0.12	0.05 - 0.10	0.05 - 0.10	0.5
	Superalloys Inconel718, etc.	AH725	20 - 50	0.03 - 0.12	0.05 - 0.15	0.05 - 0.15	0.04 - 0.12	0.05 - 0.10	0.05 - 0.10	0.5

Reference pages : Toolholders → **G126**, Standard cutting conditions → **G131**

Grade
Insert
Ext. Toolholder
Int. Toolholder
Threading
Grooving
Miniature tool
Milling cutter
Endmill
Drilling tool
Tooling System
User's Guide
Index



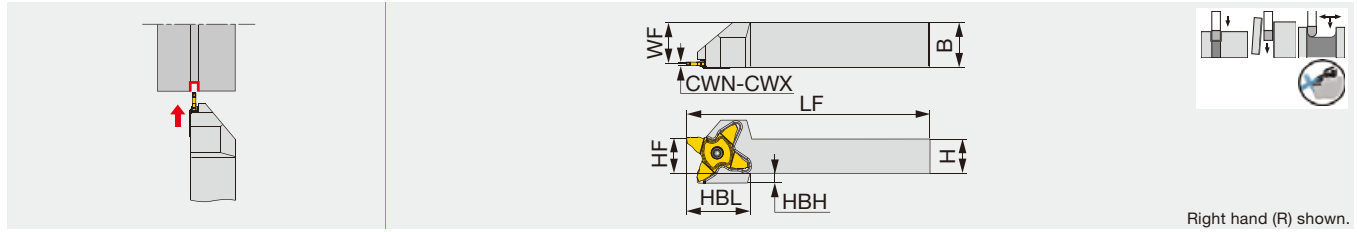

Right hand (R) shown.

Designation	CWN	CWX	H	B	LF	HF	WF	HBH	HBL	Insert	Torque*
STCR/L2020-38	1.5	4	20	20	120	20	18.1	5	35	TCL38...	2.5

Torque*: Recommended clamping torque (N-m)

SPARE PARTS

Designation	Screw	Wrench
STCR****-38 (-CHP)	SR16-212-01397L	T-2010/5
STCL****-38 (-CHP)	SR16-212-01397	T-2010/5

INSERT - FOR GROOVING AND PARTING OFF

TCL38 (for grooving and parting off)

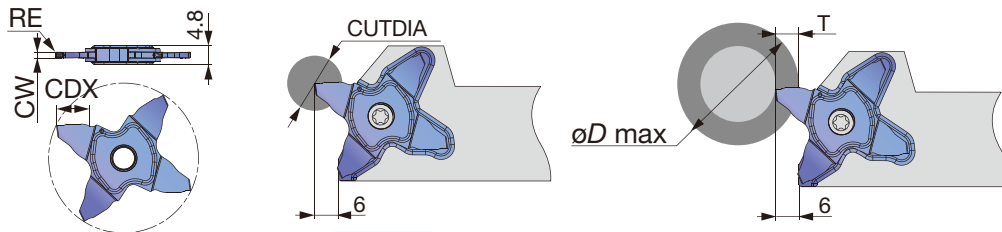

P	Steel	★		
M	Stainless	★		
K	Cast iron	★		
N	Non-ferrous			
S	Superalloys	★		
H	Hard materials			

★ : First choice

Designation	CW±0.02	RE	Coated AH7025	CDX	CUTDIA	Relation of groove depth (T) and Max. diameter (øD max)					
						T ≤ 5	T ≤ 6	T ≤ 7	T ≤ 8	T ≤ 9	T ≤ 10
TCL38-150-020	1.5	0.2	●	9	18	∞	950	315	190	45	-
TCL38-200-020	2	0.2	●	9	18	∞	950	315	190	45	-
TCL38-300-020	3	0.2	●	10	20	∞	950	315	190	130	50
TCL38-400-030	4	0.3	●	10	20	∞	950	315	190	130	50

5 pieces per package

● : Line up

STANDARD CUTTING CONDITIONS

ISO	Workpiece materials	Grades	Cutting speed Vc (m/min)	Feed: f (mm/rev)	
				Grooving, Parting	TCL38
P	Carbon steel (S45C / C45, etc.)	AH7025	80 - 180	0.03 - 0.18	
	Alloy steel (SCM435 / 34CrMo4, etc.)	AH7025	50 - 180	0.03 - 0.18	
M	Alloy steel (SCM435 / 34CrMo4, etc.)	AH7025	50 - 150	0.03 - 0.14	
K	Grey cast iron (FC250 / 250 / GG25, etc.)	AH7025	50 - 180	0.03 - 0.14	
	Ductile cast iron (FCD400 / 400-15 / GGG400, etc.)	AH7025	50 - 120	0.03 - 0.14	
S	Titanium alloys (Ti-6Al-4V, etc.)	AH7025	30 - 60	0.03 - 0.14	
	Superalloys (Inconel718, etc.)	AH7025	20 - 50	0.03 - 0.14	

Screw-on external grooving toolholder, for Swiss lathes

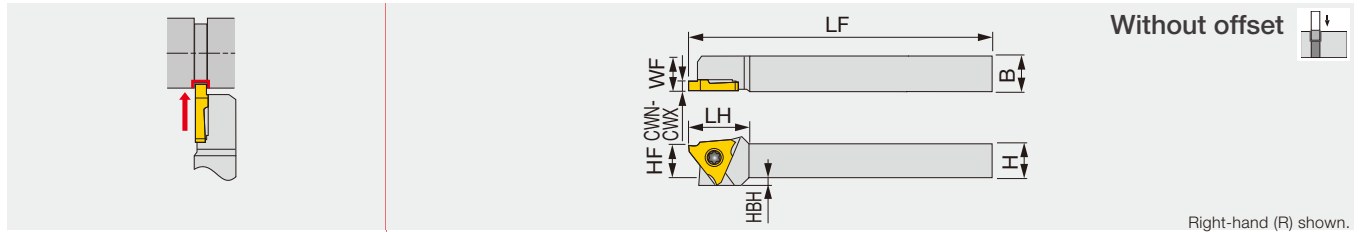

Designation	CWN	CWX	H	B	LF	LH	HF	WF	HBH	Insert	Torque*
JSTGR/L1010X3	0.33	3	10	10	120	18.5	10	10	2	JTGR/L3...	1.2
JSTGR/L1212F3	0.33	3	12	12	85	18.5	12	12	-	JTGR/L3...	1.2
JSTGR/L1212X3	0.33	3	12	12	120	18.5	12	12	-	JTGR/L3...	1.2
JSTGR/L1616X3	0.33	3	16	16	120	18.5	16	16	-	JTGR/L3...	1.2
JSTGL1616K3	0.33	3	16	16	125	18.5	16	16	-	JTGR/L3...	1.2

Torque*: Recommended clamping torque (N·m)

JS-TGL3

Screw-on external grooving toolholder, for Swiss lathes

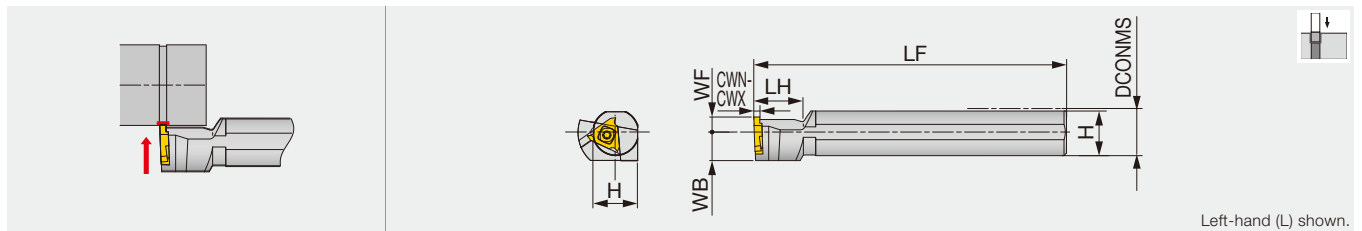

Designation	CWN	CWX	DCONMS	WF	LF	LH	H	WB	Insert	Torque*
JS19K-TGL3	0.33	3	19.05	6	125	20	18	11.5	JTGR3...	3.0
JS20K-TGL3	0.33	3	20	6	125	20	19	11.5	JTGR3...	3.0
JS22K-TGL3	0.33	3	22	6	125	20	21	11.5	JTGR3...	3.0
JS25K-TGL3	0.33	3	25.4	10	125	20	24	12.7	JTGR3...	3.0

Torque*: Recommended clamping torque (N·m)

Use left-hand toolholders (L) with right-hand inserts (R).

SPARE PARTS

Designation	Clamping screw	Wrench 1	Wrench 2 (Optional)
JSTGR/L...	CSTB-4SD	T-8F	(T-8L)
JS**-TGL3	CSTB-4S	T-15F	-

Reference pages : JSTGR/L, JS-TGL3: Inserts → **G134 - G135**,
Standard cutting conditions → **G135**

INSERT

JTG (Sharp edge)

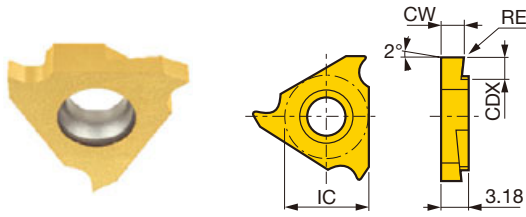

Right hand (R) shown.

P	Steel	★	★		★		☆			
M	Stainless	★	★							
K	Cast iron					☆		★		
N	Non-ferrous							★		
S	Superalloys							★		
H	Hard materials									

★ : First choice
☆ : Second choice

Designation	HAND	CW ^{+0.05}	RE	Coated		Cermet	Uncoated		CDX	IC	Max. groove depth
				SH725	J740	NS9530	TH10				
JTGR3033F	R	0.33	0.03	●	●			●	0.7	9.53	0.7
JTGL3033F	L	0.33	0.03	●	●			●	0.7	9.53	0.7
JTGR3033F-005	R	0.33	0.05	●					0.7	9.53	0.7
JTGR3043F	R	0.43	0.03	●	●				1.1	9.53	0.7
JTGR3050F	R	0.5	0.03	●	●	●		●	1.1	9.53	1.1
JTGL3050F	L	0.5	0.03	●	●			●	1.1	9.53	1.1
JTGR3050F-005	R	0.5	0.05	●					1.1	9.53	1.1
JTGL3050F-005	L	0.5	0.05	●					1.1	9.53	1.1
JTGR3065F	R	0.65	0.03	●	●				1.9	9.53	1.1
JTGR3065F-010	R	0.65	0.1	●					1.9	9.53	1.1
JTGR3075F	R	0.75	0.03	●	●	●		●	1.9	9.53	1.9
JTGL3075F	L	0.75	0.03	●	●	●		●	1.9	9.53	1.9
JTGR3075F-010	R	0.75	0.1	●					1.9	9.53	1.9
JTGL3075F-010	L	0.75	0.1	●					1.9	9.53	1.9
JTGR3080F	R	0.8	0.03	●	●				1.9	9.53	1.9
JTGR3080F-010	R	0.8	0.1	●					1.9	9.53	1.9
JTGR3085F	R	0.85	0.03	●	●				1.9	9.53	1.9
JTGR3095F	R	0.95	0.03	●	●	●		●	1.9	9.53	1.9
JTGL3095F	L	0.95	0.03	●	●			●	1.9	9.53	1.9
JTGR3095F-010	R	0.95	0.1	●					1.9	9.53	1.9
JTGL3095F-010	L	0.95	0.1	●					1.9	9.53	1.9
JTGR3100F	R	1	0.05	●	●	●		●	2.1	9.53	1.9
JTGL3100F	L	1	0.05	●	●			●	2.1	9.53	1.9
JTGR3100F-010	R	1	0.1	●					2.1	9.53	1.9
JTGL3100F-010	L	1	0.1	●					2.1	9.53	1.9
JTGR3110F	R	1.1	0.05	●	●				2.1	9.53	1.9
JTGR3120F	R	1.2	0.05	●	●				2.1	9.53	1.9
JTGR3120F-010	R	1.2	0.1	●					2.1	9.53	1.9
JTGR3125F	R	1.25	0.05	●	●	●		●	2.1	9.53	2.1
JTGL3125F	L	1.25	0.05	●	●			●	2.1	9.53	2.1
JTGR3125F-010	R	1.25	0.1	●					2.1	9.53	2.1
JTGL3125F-010	L	1.25	0.1	●					2.1	9.53	2.1
JTGR3130F	R	1.3	0.05	●	●				2.1	9.53	2.1
JTGR3140F	R	1.4	0.05	●	●				2.1	9.53	2.1
JTGR3140F-010	R	1.4	0.1	●					2.1	9.53	2.1
JTGR3145F	R	1.45	0.05	●	●	●		●	2.1	9.53	2.1
JTGL3145F	L	1.45	0.05	●	●			●	2.1	9.53	2.1
JTGR3145F-010	R	1.45	0.1	●					2.1	9.53	2.1
JTGR3150F	R	1.5	0.05	●	●	●		●	2.1	9.53	2.1
JTGL3150F	L	1.5	0.05	●	●			●	2.1	9.53	2.1
JTGR3150F-010	R	1.5	0.1	●					2.1	9.53	2.1
JTGL3150F-010	L	1.5	0.1	●					2.1	9.53	2.1
JTGR3175F	R	1.75	0.05	●	●	●		●	2.1	9.53	2.1
JTGL3175F	L	1.75	0.05	●	●	●		●	2.1	9.53	2.1
JTGR3175F-010	R	1.75	0.1	●					2.1	9.53	2.1

Reference pages: Toolholder → **G133**

●: Line up

P	Steel	★	★		★		☆				
M	Stainless	★	★								
K	Cast iron				☆		★				
N	Non-ferrous						★				
S	Superalloys						★				
H	Hard materials										

★ : First choice
☆ : Second choice

Designation	HAND	CW ₀ ^{+0.05}	RE	Coated		Cermet	Uncoated		CDX	IC	Max. groove depth
				SH725	J740	NS9530	TH10				
JTGR3180F	R	1.8	0.05	●	●				2.1	9.53	2.1
JTGR3200F	R	2	0.05	●	●	●		●	2.6	9.53	2.6
JTGL3200F	L	2	0.05	●	●			●	2.6	9.53	2.6
JTGR3200F-010	R	2	0.1	●					2.6	9.53	2.6
JTGL3200F-010	L	2	0.1	●					2.6	9.53	2.6
JTGR3225F	R	2.25	0.05	●	●				2.6	9.53	2.6
JTGR3250F	R	2.5	0.05	●	●	●		●	2.6	9.53	2.6
JTGL3250F	L	2.5	0.05	●	●			●	2.6	9.53	2.6
JTGR3250F-010	R	2.5	0.1	●					2.6	9.53	2.6
JTGL3250F-010	L	2.5	0.1	●					2.6	9.53	2.6
JTGR3275F	R	2.75	0.05		●				2.6	9.53	2.6
JTGR3300F	R	3	0.05	●	●				2.6	9.53	2.6
JTGR3300F-010	R	3	0.1	●					2.6	9.53	2.6

● : Line up

JTG (honed edge)

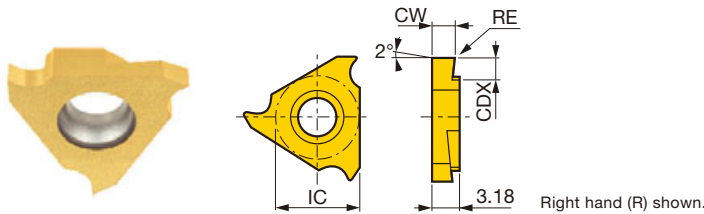

P	Steel	★									
M	Stainless										
K	Cast iron	☆									
N	Non-ferrous										
S	Superalloys	☆									
H	Hard materials										

★ : First choice
☆ : Second choice

Designation	HAND	CW ₀ ^{+0.05}	RE	Coated				CDX	IC	Max. groove depth	
				J9530							
JTGR3100	R	1	0.05	●					2.2	9.525	2.1
JTGL3100	L	1	0.05	●					2.2	9.525	2.1
JTGR3125	R	1.25	0.05	●					2.2	9.525	2.1
JTGL3125	L	1.25	0.05	●					2.2	9.525	2.1
JTGR3150	R	1.5	0.05	●					2.2	9.525	2.1
JTGL3150	L	1.5	0.05	●					2.2	9.525	2.1
JTGR3200	R	2	0.05	●					2.7	9.525	2.6
JTGL3200	L	2	0.05	●					2.7	9.525	2.6

● : Line up

STANDARD CUTTING CONDITIONS (J-Series grooving tool)

ISO	Workpiece material	Grade	Cutting Speed V _c (m/min)	Feed f (mm/rev)
P	General steels S45C, etc. C45, etc.	SH725	50 - 200	0.01 - 0.1
		J740	10 - 100	0.01 - 0.1
		NS9530	50 - 150	0.01 - 0.1
	Free-cutting steels SUM22, etc.	J9530	50 - 150	0.03 - 0.13
		SH725	50 - 200	0.01 - 0.1
M	Stainless steels SUS303, SUS304, etc.	J740	10 - 100	0.01 - 0.1
		NS9530	50 - 150	0.01 - 0.1
		J9530	50 - 150	0.03 - 0.13
N	Aluminium alloys, copper alloys Si < 12%, C3604B, etc.	TH10	10 - 200	0.01 - 0.1
S	Difficult-to-cut materials, titanium alloys Ti-6Al-4V, etc.	TH10	10 - 30	0.01 - 0.1

Screw-on toolholder without offset for front / reverse turning & external grooving

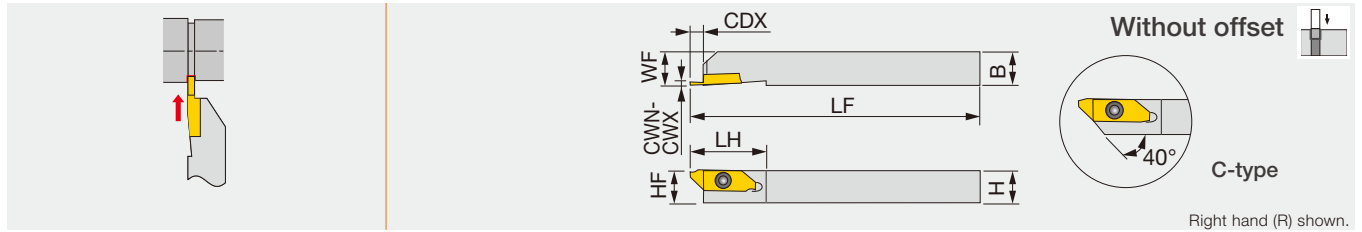

Designation	CWN	CWX	CDX	H	B	LF	LH	HF	WF	Insert
JSXGR/L1010K8-C	0.7	2	6.7	10	10	125	29	10	10	JX*R/L8...
JSXGR/L1212K8-C	0.7	2	6.7	12	12	125	29	12	12	JX*R/L8...
JSXGR/L1616K8	0.7	2	6.5	16	16	125	29	16	16	JX*R/L8...
JSXGR/L2020K8	0.7	2	6.5	20	20	125	29	20	20	JX*R/L8...

Can be wrenched also from the back with a double-head screw.

This toolholders can be used for JXG insert (grooving), JFX insert (front-turning), JXK insert (reverse-turning)

SPARE PARTS

Designation	Clamping screw	Wrench 1	Wrench 2 (Optional)
JSXGR/L	CSTB-4SD	T-8F	(T-8L)

INSERT

JXG (handed insert with sharp edge)

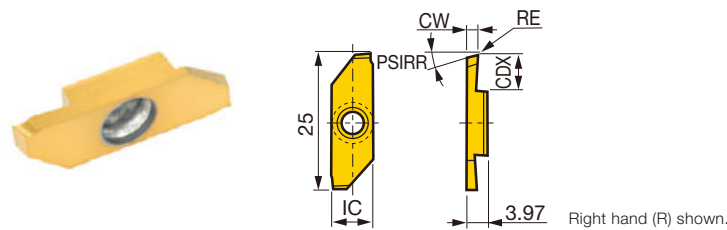

P	Steel	★		☆					
M	Stainless	★							
K	Cast iron			★					
N	Non-ferrous			★					
S	Superalloys	☆		★					
H	Hard materials								

★ : First choice
☆ : Second choice

Designation	HAND	CW±0.025	RE	Coated		Uncoated		CDX	IC	PSIRR
				J740	TH10					
JXGR8070FA	R	0.7	0	●				4.5	8	15
JXGL8070FA	L	0.7	0	●	●			4.5	8	15
JXGR8070FA-005	R	0.7	0.05	●	●			4.5	8	15
JXGR8100FA	R	1	0	●				6	8	15
JXGL8100FA	L	1	0	●	●			6	8	15
JXGR8100FA-005	R	1	0.05	●	●			6	8	15
JXGR8100FA45	R	1	0	●				4.5	8	15
JXGR8100FA45-005	R	1	0.05	●	●			4.5	8	15
JXGR8150FA	R	1.5	0	●				6	8	15
JXGL8150FA	L	1.5	0	●	●			6	8	15
JXGR8150FA-005	R	1.5	0.05	●	●			6	8	15
JXGR8150FA50	R	1.5	0	●				5	8	15
JXGR8150FA50-005	R	1.5	0.05	●	●			5	8	15
JXGR8180FA	R	1.8	0	●				6	8	15
JXGR8180FA-005	R	1.8	0.05	●	●			6	8	15
JXGR8200FA	R	2	0	●				6	8	15
JXGL8200FA	L	2	0	●	●			6	8	15
JXGR8200FA-005	R	2	0.05	●	●			6	8	0
JXGR8200FN	R	2	0	●				6	8	0
JXGL8200FN	L	2	0	●	●			6	8	0
JXGR8200FN-005	R	2	0.05	●	●			6	8	0

● : Line up

Reference pages: JSXGR/L: Standard cutting conditions → G138

JSVGR/L

Screw-on external grooving toolholder, for Swiss lathes

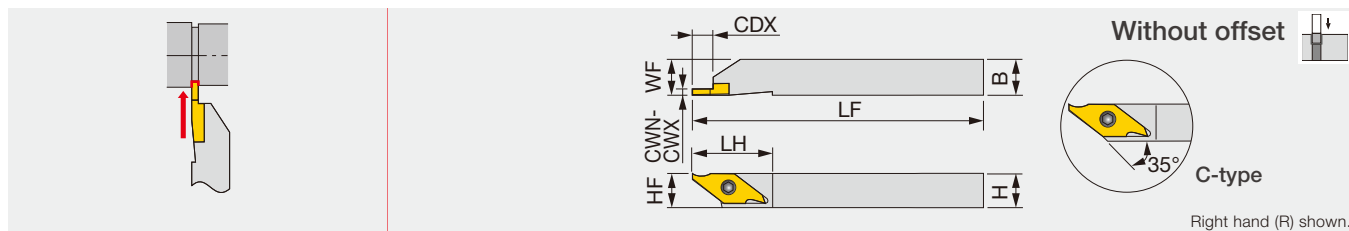

Designation	CWN	CWX	CDX	H	B	LF	LH	HF	WF	Insert	Torque*
JSVGR/L1010K-C	0.33	2	6.2	10	10	125	23	10	10	JVGR/L...	2.3
JSVGR/L1212K-C	0.33	2	6.2	12	12	125	23	12	12	JVGR/L...	2.3
JSVGR/L1616K	0.33	2	6.2	16	16	125	23	16	16	JVGR/L...	2.3

* Torque: Recommended torque (N-m) for clamping

SPARE PARTS

Designation	Clamping screw	Wrench 1	Wrench 2 (Optional)
JSVGR/L	CSTB-3S	T-9F	(T-9L)

INSERT

JVG (with hand, sharp edge)

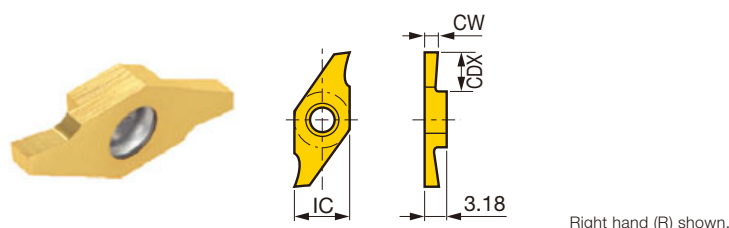

P	Steel	★	★		★		☆				
M	Stainless	★	★								
K	Cast iron					☆		★			
N	Non-ferrous							★			
S	Superalloys		☆					★			
H	Hard materials										

★ : First choice
☆ : Second choice

Designation	HAND	CW ^{+0,05}	RE	Coated		Cermet	Uncoated		CDX	IC
				SH725	J740	NS9530	TH10			
JVGR033F	R	0.33	0	●	●				0.7	7.94
JVGL033F	L	0.33	0	●			●		0.7	7.94
JVGR050F	R	0.5	0	●	●				1.1	7.94
JVGL050F	L	0.5	0	●			●		1.1	7.94
JVGR075F	R	0.75	0	●	●				1.9	7.94
JVGL075F	L	0.75	0	●			●		1.9	7.94
JVGR095F	R	0.95	0	●	●				1.9	7.94
JVGL095F	L	0.95	0	●			●		1.9	7.94
JVGR100F	R	1	0	●	●	●			5.5	7.94
JVGL100F	L	1	0	●		●	●		5.5	7.94
JVGR125F	R	1.25	0	●	●		●		5	7.94
JVGL125F	L	1.25	0	●			●		5	7.94
JVGR150F	R	1.5	0	●	●	●			5.5	7.94
JVGL150F	L	1.5	0	●		●	●		5.5	7.94
JVGR200F	R	2	0	●	●	●	●		5.5	7.94
JVGL200F	L	2	0	●		●	●		5.5	7.94

● : Line up

Reference pages: JSVGR/L: Standard cutting conditions → G138

STANDARD CUTTING CONDITIONS (JXG and JVG inserts)

ISO	Workpiece material	Grade	Cutting speed Vc (m/min)	Feed f (mm/rev)
P	Steel S45C, etc. C45, etc.	SH725	50 - 200	0.01 - 0.1
		J740	10 - 100	0.01 - 0.1
		NS9530	50 - 150	0.01 - 0.1
		Free-cutting steel SUM22, etc. 11SMn28, etc.	SH725	50 - 200
J740			10 - 100	0.01 - 0.1
M	Stainless steel SUS303, etc. X5CrNi18-9, etc.	SH725	50 - 200	0.01 - 0.1
		J740	10 - 100	0.01 - 0.1
		NS9530	50 - 150	0.01 - 0.1
N	Aluminium alloys, Brass Si < 12%, C3604B, etc. CW614N, etc.	TH10	10 - 200	0.01 - 0.1
S	Difficult-to-machine material, Titanium alloys Ti-6Al-4V, etc.	TH10	10 - 30	0.01 - 0.1



TUNG H ^{HEAVY}GROOVE

FPGN

Lever-lock toolholder for external wide grooving and profiling

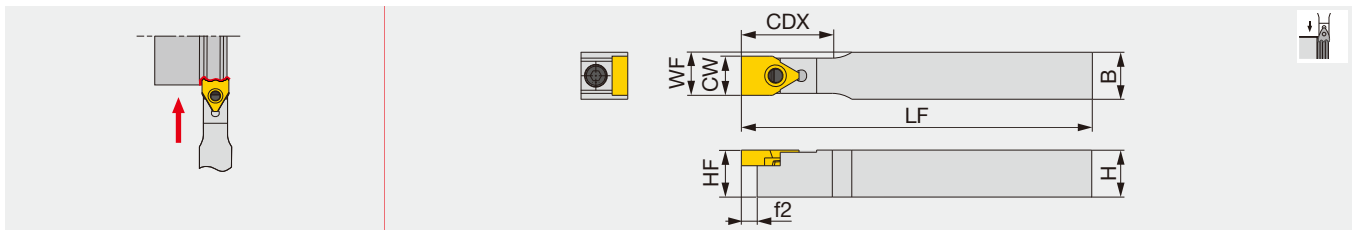

Designation	CW	CDX	H	B	LF	HF	WF	f2	Insert
FPGN1212X-10T20	10	25	12	12	125	12	11	5.5	PSGB10...
FPGN1616X-10T20	10	25	16	16	125	16	13	5.5	PSGB10...
FPGN2020K-10T20	10	25	20	20	130	20	15	5.5	PSGB10...
FPGN1616X-15T25	15	30	16	16	125	16	15.5	5.5	PSGB15...
FPGN2020K-15T25	15	30	20	20	130	20	17.5	5.5	PSGB15...
FPGN2020K-20T32	20	37	20	20	130	20	20	5.5	PSGB20...

PSGB insert blank is available for tailored inserts.

SPARE PARTS



Designation	Lever	Clamping screw	Spring	Wrench
FPGN*****-10T..., 15T...	FCL4	FCS3	BP-5	P-2.5
FPGN*****-20T..., 25T...	FCL8	FCS6	BP-9	P-5

Reference pages: FPGN: Standard cutting conditions → **G140**

SPGN

Screw-on toolholder for external wide grooving and profiling

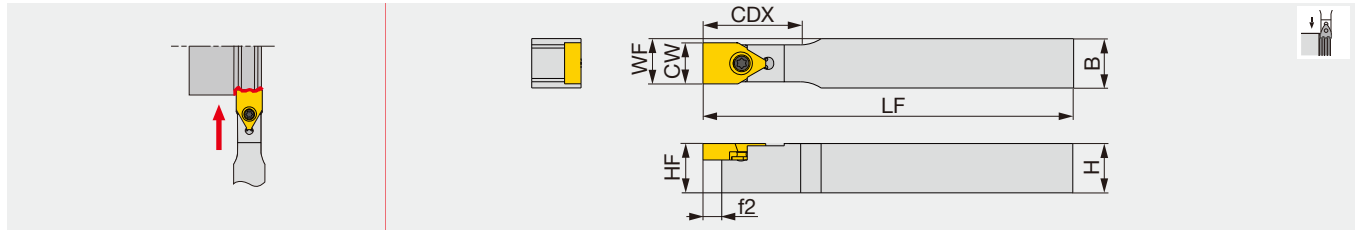

Designation	CW	CDX	H	B	LF	HF	WF	f2	Insert
SPGN1212X-10T20	10	25	12	12	125	12	11	5.5	PSGB10
SPGN1616X-10T20	10	25	16	16	125	16	13	5.5	PSGB10
SPGN2020K-10T20	10	25	20	20	130	20	15	5.5	PSGB10
SPGN1616X-15T25	15	30	16	16	125	16	15.5	5.5	PSGB15
SPGN2020K-15T25	15	30	20	20	130	20	17.5	5.5	PSGB15
SPGN2020K-20T32	20	37	20	20	130	20	20	5.5	PSGB20

PSGB insert blank is available for tailored inserts. Can be used with profile grooving inserts, only

SPARE PARTS

Designation	Clamping screw	Wrench
SPGN*****-10T20	CSTB-3L081	T-8F
SPGN*****-15T25	CSTB-4	T-15F
SPGN*****-20T..., 25T...	CSTB-5	T-20F

INSERT

PSGB (Blank for wide profile grooving inserts*)

Specially tailored profile insert

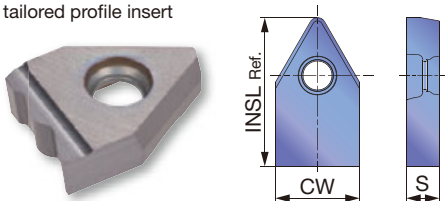

	P	M	K	N	S	H
Steel	☆	★				
Stainless		★				
Cast iron	★					
Non-ferrous	★					
Superalloys	☆					
Hard materials						

★ : First choice
☆ : Second choice

Designation	CW±0.025	Uncoated								INSL	S
		TH10	UX30								
PSGB10	10.2	●	●							18	4
PSGB15	15.2	●	●							20	5
PSGB20	20.2	●	●							27	6.5
PSGB25	25.2	●	●							27	6.5

These are blanks (semi-finished products) for wide profile grooving inserts that can be tailored.

Package quantity = 5pcs.
● : Line up

Reference pages: SPGN: Standard cutting conditions → G140

STANDARD CUTTING CONDITIONS

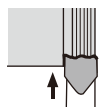

Wide profile grooving

ISO	Workpiece material	Hardness (HB)	Grade	Cutting speed Vc (m/min)
P	Steel S45C, etc. C45, etc.	< 200	UX30	50 - 150
	Alloy steel SCM440, etc. 42CrMo4, etc.	< 300	UX30	50 - 120
M	Stainless steel SUS303, etc. X5CrNi18-9, etc.	< 200	UX30	50 - 120
K	Grey cast iron FC250, etc. 250, etc.	-	TH10	50 - 150
	Ductile cast iron FCD450, etc. 450-10S, etc.	-	TH10	50 - 120
N	Aluminium alloy Si < 12%, etc.	-	TH10	100 - 500

- Custom shaped inserts can be supplied on customer's request, according to the designated final shape on part drawing.
- Semi-finished blanks PSGB types are offered for purchase.

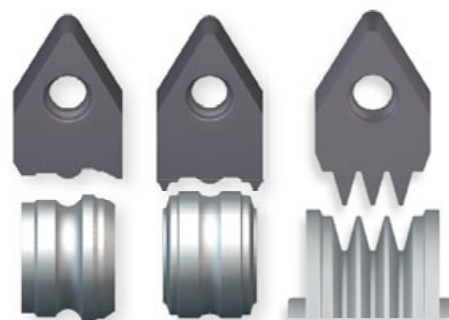

ADDICUT^{INTERNAL} A/E-STCIR/L

Internal grooving toolholder

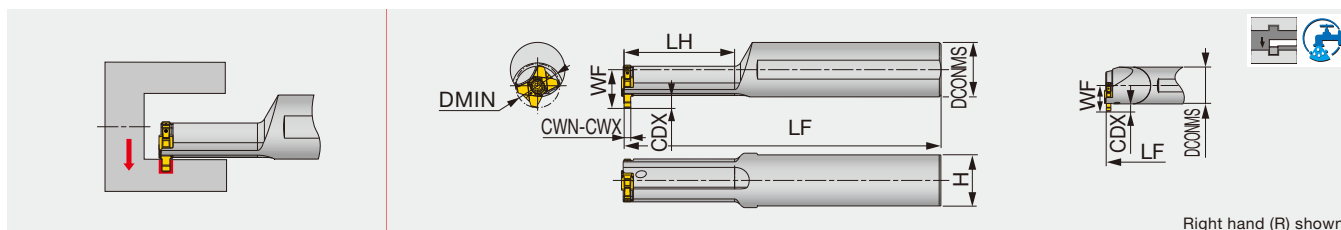

Designation	Material	CWN	CWX	DMIN	DCONMS	LH	LF	WF	H	Insert	Torque*
A12H-STCIR/L10-D105	Steel	1.5	3	10.5	12	25	100	8.3	11	TCIG10...	1
A12H-STCIR/L10-D120	Steel	1.5	3	12	12	31	100	8.3	11	TCIG10...	1
E12K-STCIR/L10-D150	Carbide	1.5	3	15	12	-	125	8.3	11	TCIG10...	1
A16J-STCIR/L12-D130	Steel	1.5	3	13	16	33	110	11.3	15	TCIG12...	1.3
A16J-STCIR/L12-D160	Steel	1.5	3	16	16	41	110	11.3	15	TCIG12...	1.3
E16M-STCIR/L12-D200	Carbide	1.5	3	20	16	-	150	11.3	15	TCIG12...	1.3

Torque*: Recommended clamping torque (N·m)

SPARE PARTS



Designation	Clamping screw
A/E-STCIR10-...	CSTB-2.2L053DR
A/E-STCIR10-...	CSTB-2.2L053DL
A/E-STCIR12-...	CSTB-2.5L054DR
A/E-STCIR12-...	CSTB-2.5L054DL

INSERTS

TCIG

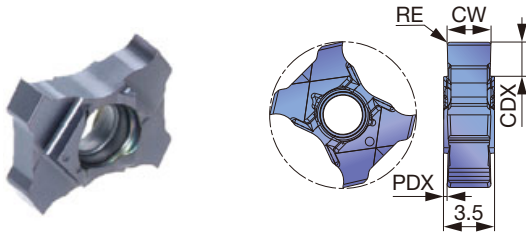

P Steel	★					
M Stainless	★					
K Cast iron	★					
N Non-ferrous						
S Superalloys	★					
H Hard materials						

★ : First choice

Designation	CW±0.025	RE	Coated				CDX	PDX
			AH725					
TCIG10-050-005	0.5	0.05	●				1	1.5
TCIG10-122-008	1.22	0.08	●				2	1.14
TCIG10-142-008	1.42	0.08	●				2	1.04
TCIG10-150-010	1.5	0.1	●				2	1
TCIG10-172-008	1.72	0.08	●				2	0.89
TCIG10-200-010	2	0.1	●				2	0.75
TCIG10-250-020	2.5	0.2	●				2	0.5
TCIG10-300-020	3	0.2	●				2	0.25
TCIG12-100-010	1	0.1	●				2.5	1.25
TCIG12-150-010	1.5	0.1	●				3	1
TCIG12-197-008	1.97	0.08	●				3	0.77
TCIG12-200-020	2	0.2	●				3	0.75
TCIG12-224-008	2.24	0.08	●				3	0.63
TCIG12-250-020	2.5	0.2	●				3	0.5
TCIG12-277-015	2.77	0.15	●				3	0.37
TCIG12-300-020	3	0.2	●				3	0.25

● : Line up

Shallower groove depths (T max) for smaller bores

Maximum groove depths (T max) for TCIG10 inserts are smaller than the CDX value shown above when the grooving bore diameter is < 12 mm; and for TCIG12, when the bore diameter is < 16 mm.

See the chart below for T max values in relation to the given bore diameter.

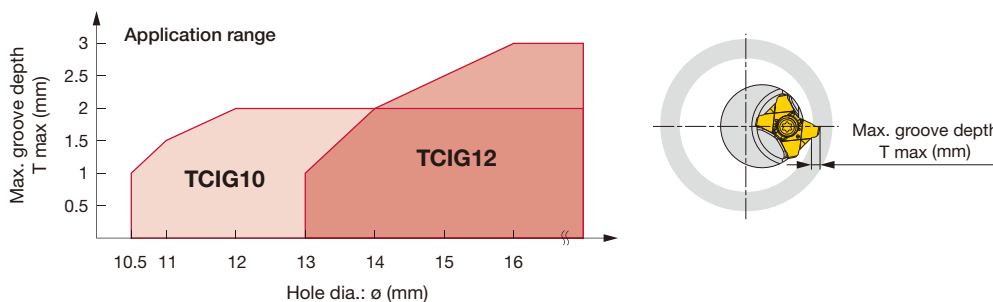

STANDARD CUTTING CONDITIONS

ISO	Workpiece material	Hardness	Priority	Cutting speed Vc (m/min)	Feed f (mm/rev)
P	Steel S45C, C45, SCM435, 34CrMo4, etc.	< 300 HB	First choice	30 - 80	0.01 - 0.05
M	Stainless steel SUS303, X10CrNiS18-9, etc.	< 200 HB	First choice	30 - 50	0.01 - 0.05
S	Titanium alloys Ti-6Al-4V, etc.	< HRC 40	First choice	10 - 50	0.01 - 0.05

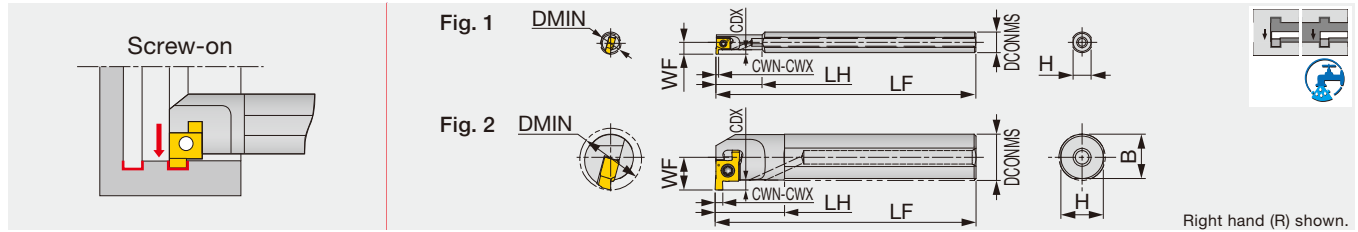

Right hand (R) shown.

Designation	Material	CWN	CWX	DMIN	CDX	DCONMS	H	B	LF	LH	WF	Insert	Torque*	Fig.
A08H-SNGR06-D080	Steel	1	2	8	1.5	8	7	-	100	18	4.73	6GMR..., 6GR...	0.7	1
A08H-SNGR07-D100	Steel	1	2	10	1.5	8	7	-	100	23	5.8	7GMR..., 7GR...	1.0	1
A10K-SNGR07-D120	Steel	1	2	12	1.5	10	9	-	125	29	6.8	7GMR..., 7GR...	1.0	1
A10K-SNGR08-D140	Steel	1.5	3.5	14	2	10	9	-	125	15	7.6	8GMR..., 8GR...	1.0	2
A12M-SNGR08-D160	Steel	1.5	3.5	16	2	12	11	11.5	150	18	8.6	8GMR..., 8GR...	1.0	2
A16Q-SNGR09-D200	Steel	1.5	3.5	20	3	16	15	15.5	180	20	11.6	9GMR..., 9GR...	1.3	2
A20R-SNGR09-D240	Steel	1.5	3.5	24	3	20	18	19	200	25	13.6	9GMR..., 9GR...	1.3	2
E08X-SNGR07-D100	Carbide	1	2	10	1.5	8	7.5	-	120.5	35	5.8	7GMR..., 7GR...	1.0	1
E10X-SNGR07-D120	Carbide	1	2	12	1.5	10	9	-	143.5	45	6.8	7GMR..., 7GR...	1.0	1
E10X-SNGR08-D140	Carbide	1.5	3.5	14	2	10	9	-	146	-	7.6	8GMR..., 8GR...	1.0	2
E12X-SNGR08-D160	Carbide	1.5	3.5	16	2	12	11	-	174.8	-	8.6	8GMR..., 8GR...	1.0	2
E16X-SNGR09-D200	Carbide	1.5	3.5	20	3	16	15	-	194.6	-	11.6	9GMR..., 9GR...	1.5	2

Note: Use the right-hand insert (□GR) with the right-hand holder (□NGR).
Torque*: Recommended clamping torque (N·m)

SPARE PARTS

Designation	Clamping screw	Wrench
A**-SNGR06-D...	CSTB-2L040	T-6F
A**-SNGR07-D...	CSTB-2.2S	T-7F
A**-SNGR08-D...	CSTB-2.2	T-7F
A**-SNGR09-D...	CSTB-2.5L080	T-8F
E**-SNGR07-D...	CSTB-2.2S	T-7F
E**-SNGR08-D...	CSTB-2.2	T-7F
E**-SNGR09-D...	CSTB-2.5L080	T-8F

SNGR/L

Toolholders for internal grooving

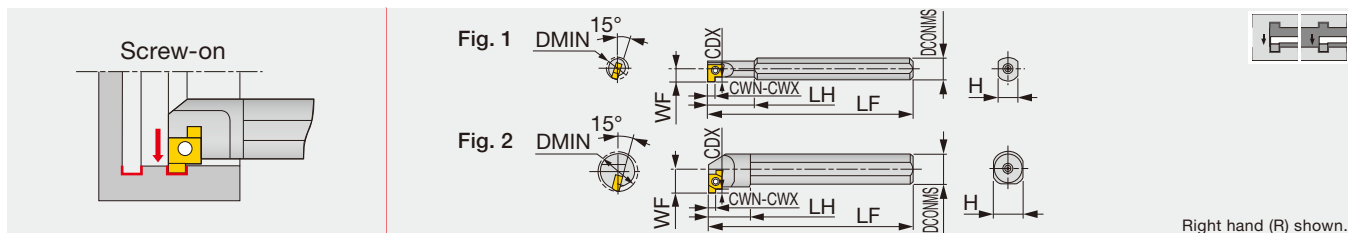

Designation	Material	CWN	CWX	DMIN	CDX	DCONMS	H	LF	LH	WF	Insert	Torque* Fig.
SNGR/L08H06	Steel	1	2	8	1.5	8	7	100	18	4.7	6GMR..., 6GR/L...	0.7 1
SNGR/L08H07	Steel	1	2	10	1.5	8	7	100	23	5.8	7GMR..., 7GR/L...	1.0 1
SNGR/L10K07	Steel	1	2	12	1.5	10	9	125	29	6.8	7GMR..., 7GR/L...	1.0 1
SNGR/L10K08	Steel	1.5	3.5	14	2	10	9	125	15	7.6	8GMR..., 8GR/L...	1.0 2
SNGR/L12M08	Steel	1.5	3.5	16	2	12	11	150	18	8.6	8GMR..., 8GR/L...	1.0 2
SNGR/L16Q09	Steel	1.5	3.5	20	3	16	15	180	20	11.6	9GMR..., 9GR/L...	1.3 2
SNGR/L20R09	Steel	1.5	3.5	24	3	20	18	200	25	13.6	9GMR..., 9GR/L...	1.3 2
SNGR/L08K06SC	Carbide	1	2	8	1.5	8	7	125	28	4.7	6GMR..., 6GR/L...	0.7 1
SNGR/L08K07SC	Carbide	1	2	10	1.5	8	7	125	35	5.8	7GMR..., 7GR/L...	1.0 1
SNGR/L10M07SC	Carbide	1	2	12	1.5	10	9	150	45	6.8	7GMR..., 7GR/L...	1.0 1
SNGR/L10M08SC	Carbide	1.5	3.5	14	2	10	9	150	45	7.6	8GMR..., 8GR/L...	1.0 2
SNGR/L12Q08SC	Carbide	1.5	3.5	16	2	12	11	180	-	8.6	8GMR..., 8GR/L...	1.0 2
SNGR/L16R09SC	Carbide	1.5	3.5	20	3	16	15	200	-	11.6	9GMR..., 9GR/L...	1.5 2

Note: Use the right-hand insert (□GR) with the right-hand holder (□NGR), and use the left-hand insert (□GL) with the left-hand holder (□NGL).
Torque*: Recommended clamping torque (N·m)

SPARE PARTS

Designation	Clamping screw	Wrench
SNGR/L***06	CSTB-2L040	T-6F
SNGR/L***07	CSTB-2.2S	T-7F
SNGR/L***08	CSTB-2.2	T-7F
SNGR/L***09	CSTB-2.5L080	T-8F
SNGR/L***06SC	CSTB-2L040	T-6F
SNGR/L***07SC	CSTB-2.2S	T-7F
SNGR/L***08SC	CSTB-2.2	T-7F
SNGR/L***09SC	CSTB-2.5L080	T-8F

CNGR/L

Toolholders for internal grooving

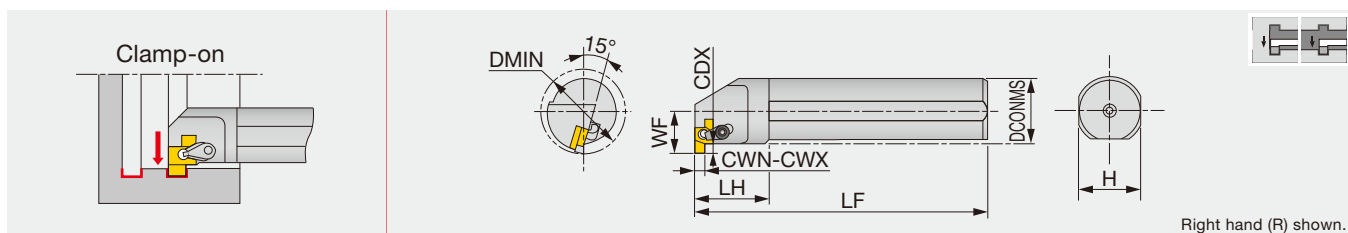

Designation	CWN	CWX	DMIN	CDX	DCONMS	H	LF	LH	WF	Insert	Torque*
CNGR/L25S15	2	5	32	5	25	23	250	30	18.1	15GR/L...	7
CNGR/L32T15	2	5	40	5	32	30	300	35	22.1	15GR/L...	7
CNGR/L40U15	2	5	48	5	40	38	350	45	26.1	15GR/L...	7

Note: Use the right-hand insert (□GR) with the right-hand holder (□NGR), and use the left-hand insert (□GL) with the left-hand holder (□NGL).
Torque*: Recommended clamping torque (N·m)

Optional parts for CNG holders

Use the following parts for screw clamp options.

SPARE PARTS

Designation	Clamp set	Screw	Shim	Wrench
CNGR...	CSP22	DTS5-3.5	SGSR151	T-20F
CNGL...	CSP22	DTS5-3.5	SGSL151	T-20F

Designation	Clamping screw	Wrench
CNGR/L...	CSTB-3.5L	T-15F

Reference pages: SNGR/L, CNGR/L: Inserts → **G144, G145**, Standard cutting conditions → **G146**

INSERTS

**GMR/L

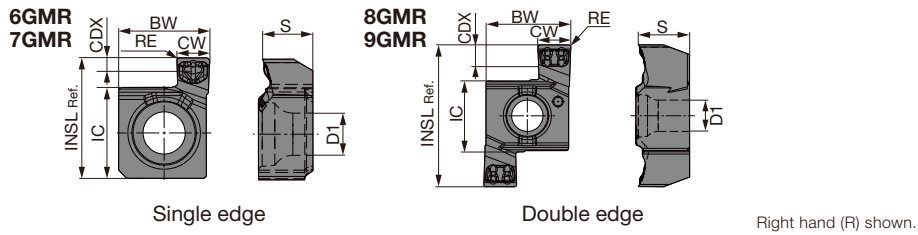

P	Steel	★								
M	Stainless	★								
K	Cast iron	★								
N	Non-ferrous									
S	Superalloys	★								
H	Hard materials									

★ : First choice
☆ : Second choice

Designation	HAND	CW±0.025	RE	Coated					CDX	BW	S	IC	INSL	D1
				AH7025										
6GMR100-015	R	1	0.15	●					1.5	5.56	2.34	4.76	6.44	2.3
7GMR200-020	R	2	0.2	●					1.5	5.56	3.08	5.56	7.36	2.58
8GMR150-020	R	1.5	0.2	●					2	6.15	3.87	5.56	10.16	2.58
9GMR200-020	R	2	0.2	●					3	7.74	4.66	6.35	12.95	2.86
9GMR300-020	R	3	0.2	●					3	7.74	4.66	6.35	12.95	2.86

● : Line up



Reference pages: Toolholder → [G142](#), [G143](#), Standard cutting conditions → [G146](#)

****GR/L**

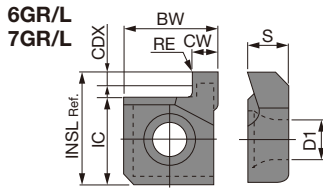

Single edge

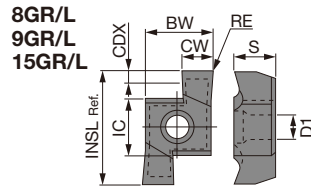

Double edge

Right hand (R) shown.

P Steel	★			★		
M Stainless				★		
K Cast iron	☆		★			
N Non-ferrous			★			
S Superalloys			☆			
H Hard materials						

★ : First choice
☆ : Second choice

Designation	HAND	CW±0.025	RE	Cermet		Uncoated		CDX	BW	S	IC	INSL	D1
				NS9530		TH10	UX30						
6GR100	R	1	0.2	●		●		1.5	5.6	2.34	4.76	6.44	2.3
6GL100	L	1	0.2				●	1.5	5.6	2.34	4.76	6.44	2.3
6GR150	R	1.5	0.2	●		●	●	1.5	5.6	2.34	4.76	6.44	2.3
6GL150	L	1.5	0.2			●	●	1.5	5.6	2.34	4.76	6.44	2.3
6GR200	R	2	0.2	●		●	●	1.5	5.6	2.34	4.76	6.44	2.3
6GL200	L	2	0.2			●	●	1.5	5.6	2.34	4.76	6.44	2.3
7GR100	R	1	0.2	●		●	●	1.5	5.6	3.08	5.56	7.36	2.58
7GR150	R	1.5	0.2	●		●	●	1.5	5.6	3.08	5.56	7.36	2.58
7GR200	R	2	0.2	●		●	●	1.5	5.6	3.08	5.56	7.36	2.58
7GL200	L	2	0.2			●	●	1.5	5.6	3.08	5.56	7.36	2.58
8GR150	R	1.5	0.2	●		●	●	2	6.2	3.87	5.56	10.16	2.58
8GR200	R	2	0.2	●		●	●	2	6.2	3.87	5.56	10.16	2.58
8GL200	L	2	0.2			●		2	6.2	3.87	5.56	10.16	2.58
8GR250	R	2.5	0.2	●		●	●	2	6.2	3.87	5.56	10.16	2.58
8GL250	L	2.5	0.2			●	●	2	6.2	3.87	5.56	10.16	2.58
8GR300	R	3	0.2	●		●	●	2	6.2	3.87	5.56	10.16	2.58
8GL300	L	3	0.2			●	●	2	6.2	3.87	5.56	10.16	2.58
8GR350	R	3.5	0.2	●		●	●	2	6.2	3.87	5.56	10.16	2.58
9GR150	R	1.5	0.2	●		●	●	2	7.7	4.66	6.35	12.95	2.86
9GL150	L	1.5	0.2	●			●	2	7.7	4.66	6.35	12.95	2.86
9GR200	R	2	0.2	●		●	●	3	7.7	4.66	6.35	12.95	2.86
9GL200	L	2	0.2	●		●	●	3	7.7	4.66	6.35	12.95	2.86
9GR250	R	2.5	0.2	●		●	●	3	7.7	4.66	6.35	12.95	2.86
9GL250	L	2.5	0.2	●			●	3	7.7	4.66	6.35	12.95	2.86
9GR300	R	3	0.2	●		●	●	3	7.7	4.66	6.35	12.95	2.86
9GL300	L	3	0.2	●		●	●	3	7.7	4.66	6.35	12.95	2.86
9GR350	R	3.5	0.2	●		●	●	3	7.7	4.66	6.35	12.95	2.86
9GL350	L	3.5	0.2	●			●	3	7.7	4.66	6.35	12.95	2.86
15GR200	R	2	0.2	●		●	●	3	10.8	5.1	9.2	20.8	4.8
15GR250	R	2.5	0.2	●		●	●	3	10.8	5.1	9.2	20.8	4.8
15GR300	R	3	0.2	●		●	●	3	10.8	5.1	9.2	20.8	4.8
15GL300	L	3	0.2				●	3	10.8	5.1	9.2	20.8	4.8
15GR350	R	3.5	0.2	●		●	●	3	10.8	5.1	9.2	20.8	4.8
15GR400	R	4	0.2	●		●	●	4	10.8	5.1	9.2	20.8	4.8
15GR450	R	4.5	0.2	●		●	●	4	10.8	5.1	9.2	20.8	4.8
15GL450	L	4.5	0.2			●		4	10.8	5.1	9.2	20.8	4.8
15GR500	R	5	0.2	●		●	●	5	10.8	5.1	9.2	20.8	4.8

Note: Use the right-hand insert (□GR) with the right-hand holder (□NGR), and use the left-hand insert (□GL) with the left-hand holder (□NGL).

● : Line up

Reference pages: Toolholder → **G142, G143**, Standard cutting conditions → **G146**



STANDARD CUTTING CONDITIONS

ISO	Workpiece material	Grade	Cutting speed Vc (m/min)	Feed rate: <i>f</i> (mm/rev)	
				**GMR...	**GR/L...
P	Carbon steel S45C, C45, etc.	AH7025	80 - 180	0.03 - 0.12	-
		NS9530	80 - 200	-	0.05 - 0.15
		UX30	40 - 150	-	0.05 - 0.15
	Alloy steel SCM435, 34CrMo4, etc.	AH7025	80 - 180	0.03 - 0.12	-
		NS9530	80 - 200	-	0.05 - 0.15
		UX30	40 - 150	-	0.05 - 0.15
M	Stainless steel SUS304, X5CrNi18-9, etc.	AH7025	50 - 120	0.03 - 0.12	-
		UX30	40 - 100	-	0.03 - 0.10
K	Grey cast irons F250, GG25, 250, etc.	AH7025	50 - 220	0.03 - 0.12	-
		TH10	60 - 200	-	0.05 - 0.15
	Ductile cast irons FCD400, etc.	AH7025	50 - 180	0.03 - 0.12	-
		TH10	40 - 160	-	0.05 - 0.15
S	Titanium alloys Ti-6Al-4V, etc.	AH7025	30 - 80	0.03 - 0.12	-
		TH10	20 - 50	-	0.05 - 0.08
	Superalloys Inconel718, etc.	AH7025	20 - 60	0.03 - 0.12	-
		TH10	10 - 30	-	0.03 - 0.08



External



Internal



Grooving



Threading



Parting-off

Face grooving toolholder with round shank

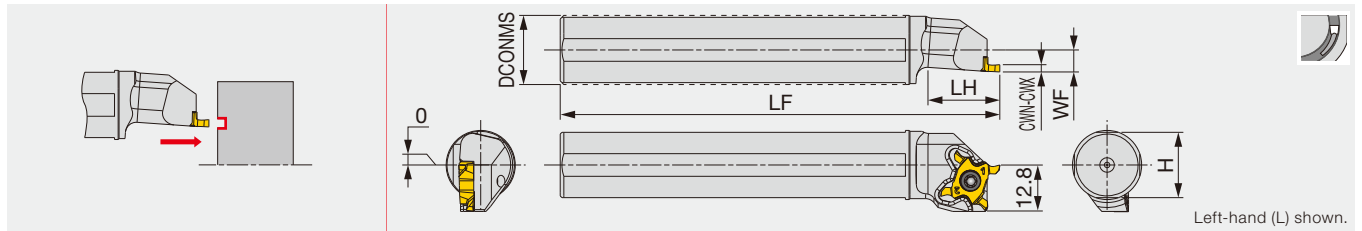

Designation	CWN	CWX	DCONMS	LF	LH	H	WF	Insert	Torque*
JS16F-STCFL18	0.5	2.5	16	85	20	15	6	TCF18L...	1.2
JS19G-STCFL18	0.5	2.5	19.05	90	20	18	6	TCF18L...	1.2
JS19X-STCFL18	0.5	2.5	19.05	120	20	18	6	TCF18L...	1.2
JS20G-STCFL18	0.5	2.5	20	90	20	19	6	TCF18L...	1.2
JS20X-STCFL18	0.5	2.5	20	120	20	19	6	TCF18L...	1.2
JS22X-STCFL18	0.5	2.5	22	120	20	21	6	TCF18L...	1.2
JS25H-STCFL18	0.5	2.5	25	100	20	24	6	TCF18L...	1.2
JS254X-STCFL18	0.5	2.5	25.4	120	20	24.5	6	TCF18L...	1.2

Note: The left hand insert (L) is used for the left hand toolholders (L).
Torque*: Recommended clamping torque: N·m

STCFVR-18

Face grooving toolholder with square shank, for Swiss lathes

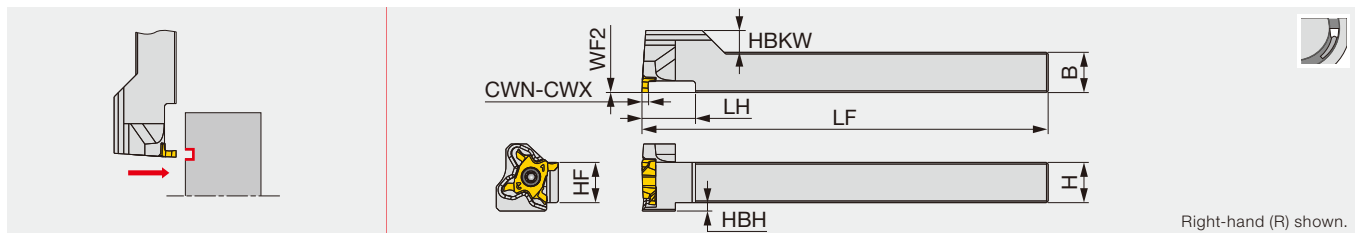

Designation	CWN	CWX	H	B	LF	LH	HF	WF2	HBKW	HBH	Insert	Torque*
STCFVR1010H18	0.5	2.5	10	10	100	12	10	0	8.5	4.5	TCF18L...	1.2
STCFVR1212F18	0.5	2.5	12	12	85	16	12	0	6.5	2.5	TCF18L...	1.2
STCFVR1212X18	0.5	2.5	12	12	120	16	12	0	6.5	2.5	TCF18L...	1.2
STCFVR1616X18	0.5	2.5	16	16	120	20	16	0	2.5	0	TCF18L...	1.2

Note: The left hand insert (L) is used for the right hand toolholders (R).
Torque*: Recommended clamping torque: N·m

STCR/L-18

Precision grooving tools with uniquely shaped insert for swiss type machine and general lathes

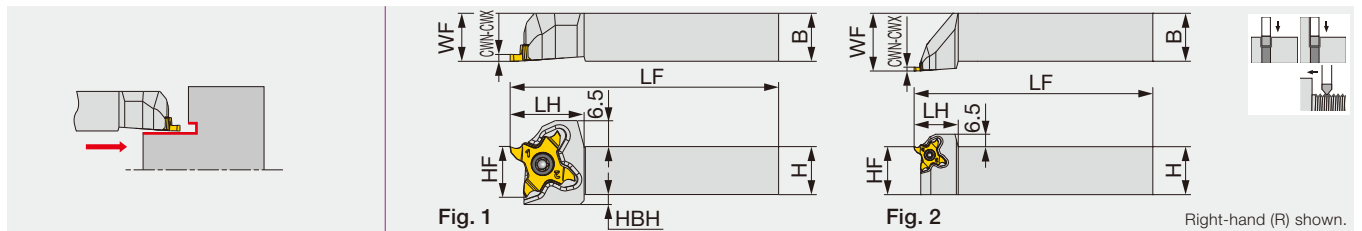

Designation	CWN	CWX	H	B	LF	LH	HF	WF	HBH	Insert	Torque*	Fig.
STCR/L1010X18	0.33	3.18	10	10	120	18.5	10	10	4.5	TC*18...	1.2	1
STCR/L1212F18	0.33	3.18	12	12	85	18.5	12	12	2.5	TC*18...	1.2	1
STCR/L1212X18	0.33	3.18	12	12	120	18.5	12	12	2.5	TC*18...	1.2	1
STCR/L1616X18	0.33	3.18	16	16	120	18.5	16	16	-	TC*18...	1.2	1
STCR/L2020H18	0.33	3.18	20	20	100	18.5	20	20	-	TC*18...	1.2	1
STCR/L2020X18	0.33	3.18	20	20	120	23	20	25	-	TC*18...	1.2	2

The right hand insert (TC*18R...) is used for the right hand toolholders (STCR...), and the left hand insert is used for the left hand toolholders
*Torque: Recommended clamping torque: N·m

SPARE PARTS

Designation	Clamping screw	Wrench
JS**-STCFL18, STCFVR**18, STCL**18	CSTC-4L100DR	T-1008/5
STCR**18	CSTC-4L100DL	T-1008/5

Threading pitch range: 0.8 - 3 mm

Reference pages :
JS-STCFL18, STCFVR-18, STCR/L-18:
Inserts, Standard cutting conditions → **G149**

External grooving and threading toolholder, high pressure coolant compatible

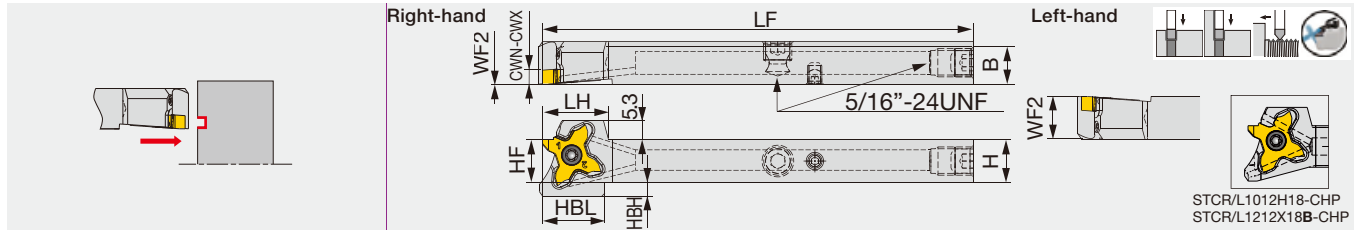

Designation	CWN	CWX	H	B	LF	LH	HBL	HF	WF2	HBH	Insert	Torque*
STCR/L1012H18-CHP	0.33	3.18	10	12	100	17.1	17.1	10	0/12	4	TC**18	1.2
STCR/L1212X18B-CHP	0.33	3.18	12	12	120	18.5	17.5	12	0/12	4	TC**18	1.2
STCR/L1616X18-CHP	0.33	3.18	16	16	120	18.5	-	16	0/16	0	TC**18	1.2

STCR/L-18-CHP

External grooving and threading toolholder. High pressure coolant capability.

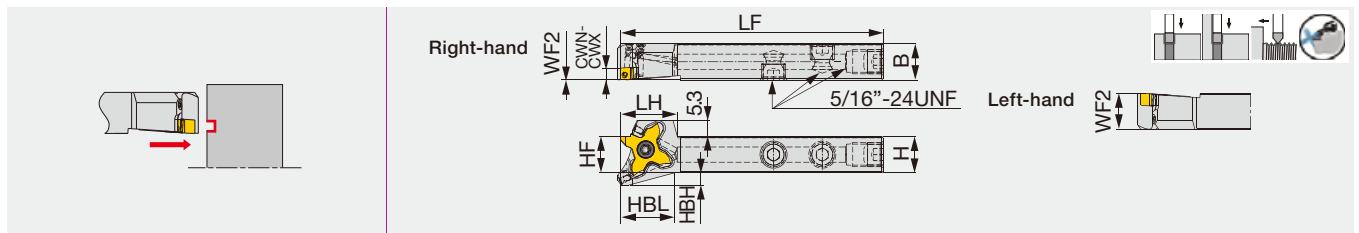

Designation	CWN	CWX	H	B	LF	LH	HBL	HF	WF2 ⁽¹⁾	HBH	Insert	Torque*
STCR/L1212F18B-CHP	0.33	3.18	12	12	85	18.5	17.5	12	0/12	4	TC**18	1.2

The right hand insert (TC*18R**) is used for the right hand toolholders (STCR**), and the left hand insert (TC*18L**) is used for the left hand toolholders (STCL**).
 (1) "0/12" for the WF dimension indicates WF = 0 for the right handed tool, WF = 12 for the left handed tool.
 *Torque: Recommended torque (N·m) for clamping

SPARE PARTS

Designation	Clamping screw	Wrench	Coolant plug	Wrench	DirectJet plug	Wrench
STCL**18-CHP	CSTC-4L100DR	T-1008/5	SR5/16UNFTL360	P-4	SSHM4-6-TB	P-2
STCR**18-CHP	CSTC-4L100DL	T-1008/5	SR5/16UNFTL360	P-4	SSHM4-6-TB	P-2
STCL**F18B-CHP	CSTC-4L100DR	T-1008/5	SR5/16UNFTL360	P-4	-	-
STCR**F18B-CHP	CSTC-4L100DL	T-1008/5	SR5/16UNFTL360	P-4	-	-

Threading pitch range: 0.8 - 3.0 mm

INSERT

TCF18L (Face grooving)

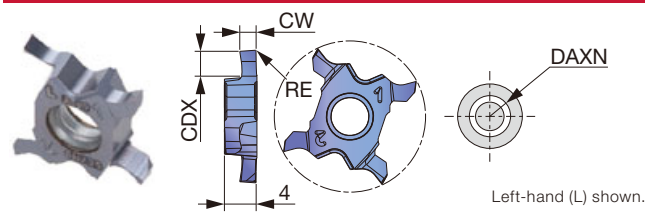

P	Steel	★									
M	Stainless	★									
K	Cast iron	★									
N	Non-ferrous										
S	Superalloys	★									
H	Hard materials										

★: First choice

Designation	HAND	CW±0.02	RE	Coated								CDX	DAXN
				SH725									
TCF18L050F-005	L	0.5	0.05	●								1	6
TCF18L100F-005	L	1	0.05	●								2.5	6
TCF18L150F-005	L	1.5	0.05	●								2.5	6
TCF18L200F-005	L	2	0.05	●								3	6
TCF18L250F-005	L	2.5	0.05	●								3	6

5 pieces per package
● : Line up

STANDARD CUTTING CONDITIONS

TCF18L (Face grooving)

ISO	Workpiece materials	Grades	Cutting speed Vc (m/min)	Feed f (mm/rev)
P	Low carbon steel S15C, C15E, C15E4, S20C, C20, etc.	SH725	30 - 100	0.01 - 0.04
	Carbon steels, Alloy steel S55C, C55, SCM440, 42CrMoS4, etc.	SH725	30 - 100	0.01 - 0.04
	Prehardened steel NAK80, PX5, etc.	SH725	30 - 100	0.01 - 0.04
M	Stainless steel SUS304, X5CrNi18-9, X5CrNiMo17-12-2, etc.	SH725	30 - 100	0.01 - 0.04
K	Grey cast iron FC250, GG25, 250, FC300, GG30, 300, etc.	SH725	30 - 100	0.01 - 0.04
	Ductile cast iron FCD400, 400-15, FCD600, GGG60, 600-3, etc.	SH725	30 - 100	0.01 - 0.04
S	Titanium alloys Ti-6Al-4V, etc.	SH725	20 - 40	0.01 - 0.04
	Superalloys Inconel718, etc.	SH725	10 - 30	0.01 - 0.04

PRECAUTIONS OF PROCESSING

Minimum diameter for face grooving

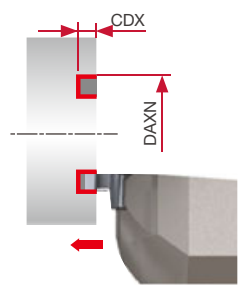

Minimum face diameter DAXN (mm)	Maximum groove depth CDX (mm)
65	3

MINI V LOCK QC12-SVER/L-CHP

Modular head for external grooving and threading, with high pressure coolant capability

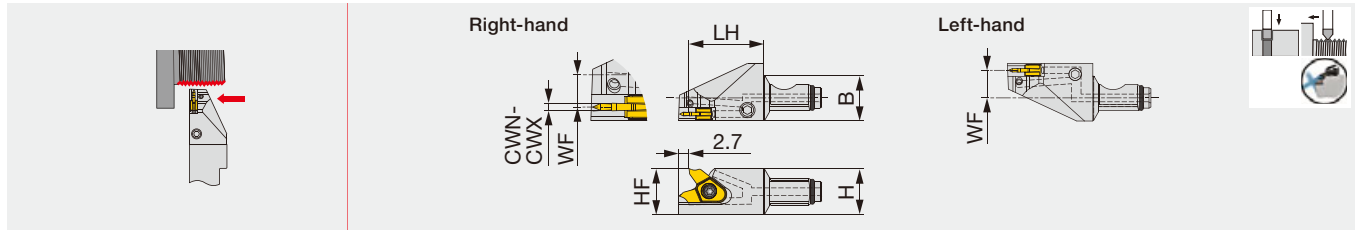

Designation	Pitch	TPI	H	B	LH	HF	WF (1)	Insert	Torque*
QC12-SVER/L10-CHP	0.4 - 1.5	64 - 12	12	12	19.5	12	4.19/7.19	VG*10...	1.3

Torque*: Recommended clamping torque (N-m)

(1) "WF" indicates the distance from the reference position to the center of the cutting edge width.

The first value before "/" indicates the WF for the right-hand holder and the second value after "/" for the left-hand holder.

SVER/L

External grooving and threading toolholder

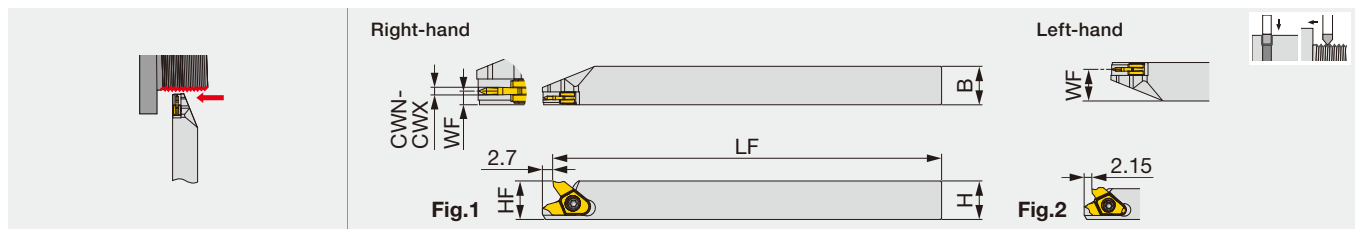

Designation	Pitch	TPI	H	B	LF	HF	WF (1)	Insert	Torque*	Fig.
SVER/L1010H10	0.4 - 1.5	64 - 12	10	10	100	10	1.78/8.23	VG*10...	1.3	1
SVER/L1212X10	0.4 - 1.5	64 - 12	12	12	120	12	1.78/10.23	VG*10...	1.3	1

Torque*: Recommended clamping torque (N-m)

(1) "WF" indicates the distance from the reference position to the center of the cutting edge width.

The first value before "/" indicates the WF for the right-hand holder and the second value after "/" for the left-hand holder.

SVER/L-CHP

External grooving and threading toolholder, with high pressure coolant capability

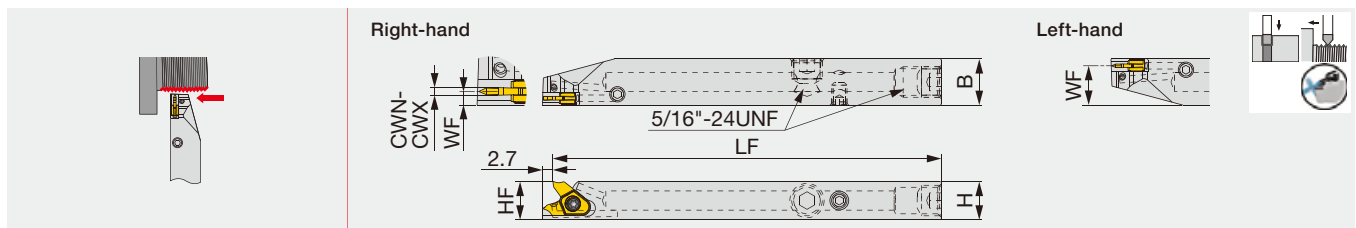

Designation	Pitch	TPI	H	B	LF	HF	WF (1)	Insert	Torque*
SVER/L1012H10-CHP	0.4 - 1.5	64 - 12	10	12	100	10	1.78/10.23	VG*10...	1.3
SVER/L1212X10-CHP	0.4 - 1.5	64 - 12	12	12	120	12	1.78/10.23	VG*10...	1.3

Compatible to the direct internal coolant supply system without the use of external coolant hose.

Torque*: Recommended clamping torque (N-m)

(1) "WF" indicates the distance from the reference position to the center of the cutting edge width. The first value before "/" indicates the WF for the right-hand holder and the second value after "/" for the left-hand holder.

SPARE PARTS

Designation	Clamping screw	Wrench 1	O-ring	Coolant plug	Wrench 2	DirectJet plug	Wrench 3
QC12-SVER...	CSTB-2.5L054DL	T-7F	ORSS-0454.5X1.0NBR70	-	-	-	-
QC12-SVEL...	CSTB-2.5L054DR	T-7F	ORSS-0454.5X1.0NBR70	-	-	-	-
SVER1012/1212...	CSTB-2.5L054DL	T-7F	-	SR5/16UNFTL360	P-4	SSHM4-6-TB	P-2
SVEL1012/1212...	CSTB-2.5L054DR	T-7F	-	SR5/16UNFTL360	P-4	SSHM4-6-TB	P-2
SVER0808...	CSTB-2.2L053DL	T-7F	-	-	-	-	-
SVEL0808...	CSTB-2.2L053DR	T-7F	-	-	-	-	-
SVER1010/1212...	CSTB-2.5L054DL	T-7F	-	-	-	-	-
SVEL1010/1212...	CSTB-2.5L054DR	T-7F	-	-	-	-	-

Reference pages: QC12-SVER/L-CHP, SVER/L, SVER/L-CHP: Shank, Accessory → [G095](#), [G096](#)

INSERT

VGT10 (For threading / sharp edge)

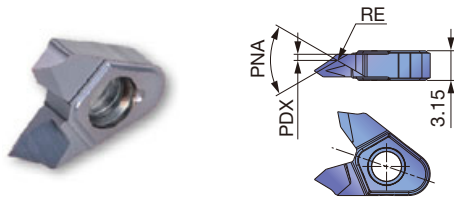

P	Steel	★					
M	Stainless	★					
K	Cast iron						
N	Non-ferrous	★					
S	Superalloys	★					
H	Hard materials						

★ : First choice

Designation	RE	Coated					Pitch	TPI	PDX	PNA
		SH725								
VGT10F-60A-005	0.05	●					0.4 - 1	64 - 25	0.66	60°
VGT10F-60A-010	0.1	●					1 - 2	25 - 12	0.96	60°
VGT10F-55A-005	0.05	●					0.6 - 1.5	40 - 16	0.85	55°

● : Line up

STANDARD CUTTING CONDITIONS

Threading

ISO	Workpiece materials	Grade	Cutting speed Vc (m/min)	Pitch (mm)	TPI
P	Low carbon steels S15C, SS400, etc. C15E4, E275A, etc.	SH725	50 - 150	0.4 - 2	64 - 12
	Carbon steels, Alloy steels S55C, SCM440, etc. C55, 42CrMo4, etc.	SH725	50 - 150	0.4 - 2	64 - 12
	Free cutting steels SUH22, SUH23, etc.	SH725	50 - 150	0.4 - 2	64 - 12
M	Stainless steels SUS304, X5CrNi18-9, etc.	SH725	50 - 100	0.4 - 2	64 - 12
N	Aluminium alloys A5056, A6061, etc.	SH725	150 - 200	0.4 - 2	64 - 12
	Copper alloy C2600, C280C, etc.	SH725	100 - 200	0.4 - 2	64 - 12
S	Titanium alloys Ti-6Al-4V, etc.	SH725	30 - 80	0.4 - 2	64 - 12
	Superalloys Inconel718, etc.	SH725	30 - 80	0.4 - 2	64 - 12

Grade
Insert
Ext. Toolholder
Int. Toolholder
Threading
Grooving
Miniature tool
Milling cutter
Endmill
Drilling tool
Tooling System
User's Guide
Index

A
B
C
D
E
F
G
H
I
J
K
L
M

Y-axis turning modular head for external grooving and threading

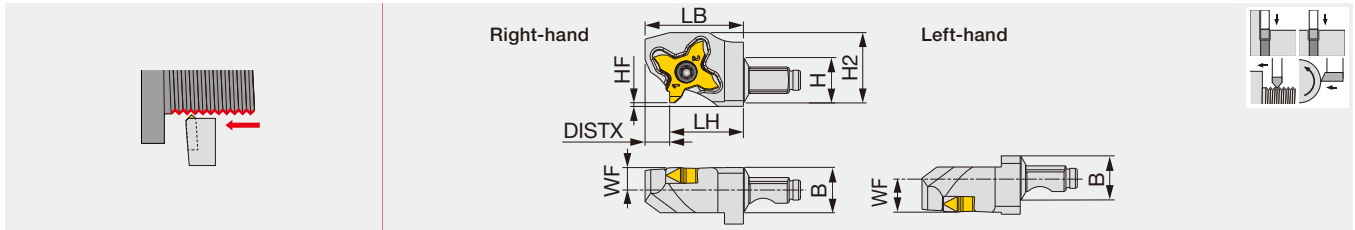

Designation	Pitch	H	B	LH	HF	WF	LB	H2	DISTX	Insert	Torque*
QC12-STCR/L18-Y	0.4 - 3	12	12	19.5	0	6	26	18.6	6.5	TC*18R/L...	1.2

Torque*: Recommended clamping torque (N-m)

The right hand insert (R) is used for the right hand toolholders (R), and the left hand insert (L) is used for the left hand toolholders (L).

QC12-STCR/L-Y-CHP

Y-axis turning modular head for external grooving and threading, with high pressure coolant capability

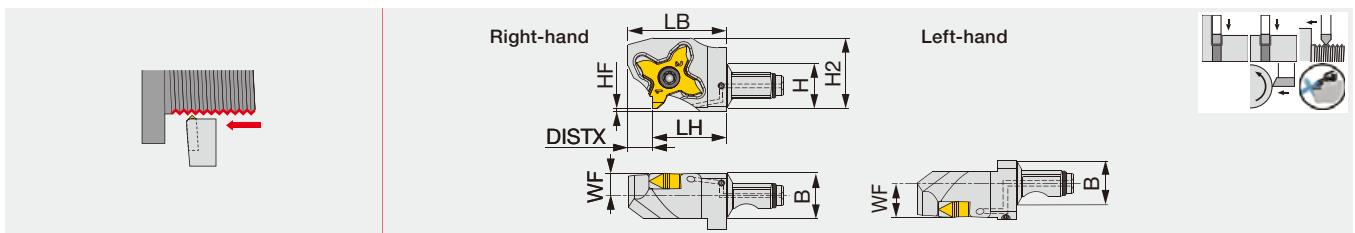

Designation	Pitch	H	B	LH	HF	WF	LB	H2	DISTX	Insert	Torque*
QC12-STCR/L18-Y-CHP	0.4 - 3	12	12	19.5	0	6	26	18.6	6.5	TC*18R/L...	1.2

Torque*: Recommended clamping torque (N-m)

The right hand insert (R) is used for the right hand toolholders (R), and the left hand insert (L) is used for the left hand toolholders (L).
Through-coolant head

SPARE PARTS

Designation	Clamping screw	Wrench	O-ring
QC12-STCR18-Y	CSTC-4L100DL	T-1008/5	-
QC12-STCL18-Y	CSTC-4L100DR	T-1008/5	-
QC12-STCR18-Y-CHP	CSTC-4L100DL	T-1008/5	ORSS-0454.5X1.0NBR70
QC12-STCL18-Y-CHP	CSTC-4L100DR	T-1008/5	ORSS-0454.5X1.0NBR70

Reference pages: QC12-STC/LR-Y, QC12-STCR/L-Y-CHP: Inserts → [G156](#), [G157](#)
Shank, Accessory → [G095](#), [G096](#), Standard cutting conditions → [G157](#)

QC12-STCR/L

Modular head for external grooving and threading

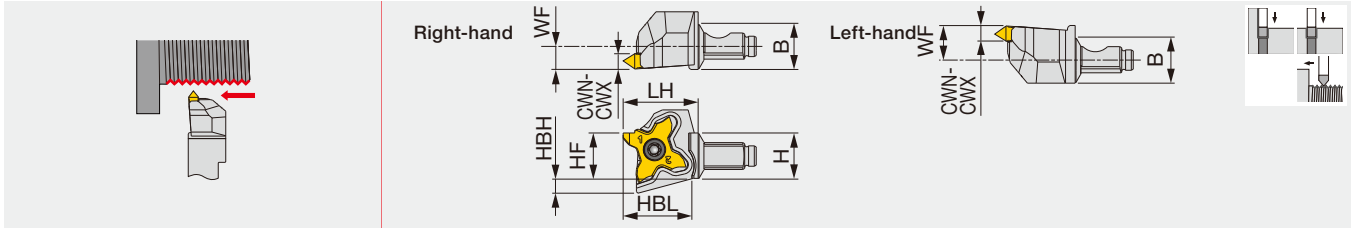

Designation	Pitch	H	B	LH	HF	HBH	HBL	WF	Insert	Torque*
QC12-STCR/L18	0.4 - 3	12	12	21	12	3.9	18.3	9	TC*18R/L...	1.2

Torque*: Recommended clamping torque (N-m)

The right hand insert (R) is used for the right hand toolholders (R), and the left hand insert (L) is used for the left hand toolholders (L).

QC12-STCR/L-CHP

Modular head for external grooving and threading, with high pressure coolant capability

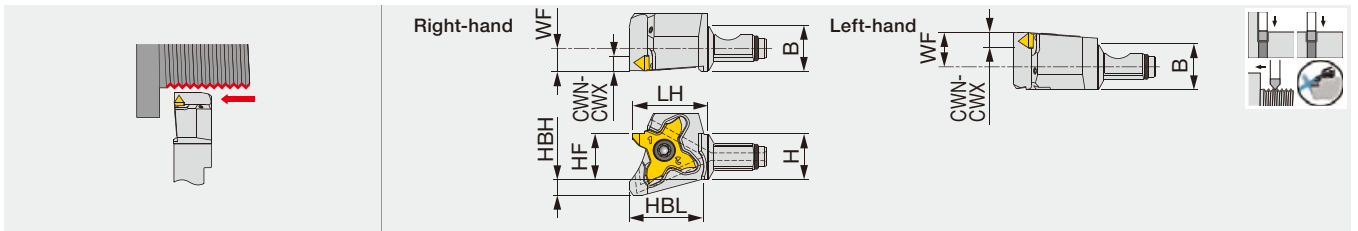

Designation	Pitch	H	B	LH	HF	HBH	HBL	WF	Insert	Torque*
QC12-STCR/L18-CHP	0.4 - 3	12	12	21	12	4.2	19.3	9	TC*18R/L...	1.2

Torque*: Recommended clamping torque (N-m)

The right hand insert (R) is used for the right hand toolholders (R), and the left hand insert (L) is used for the left hand toolholders (L).

Through-coolant head

SPARE PARTS

Designation	Clamping screw	Wrench	O-ring
QC12-STCR18-CHP	CSTC-4L100DL	T-1008/5	ORSS-0454.5X1.0NBR70
QC12-STCL18-CHP	CSTC-4L100DR	T-1008/5	ORSS-0454.5X1.0NBR70
QC12-STCR18	CSTC-4L100DL	T-1008/5	-
QC12-STCL18	CSTC-4L100DR	T-1008/5	-

Reference pages: QC12-STCR/L, QC12-STCR/L-CHP: Inserts → [G156](#), [G157](#)

Shank, Accessory → [G095](#), [G096](#), Standard cutting conditions → [G157](#)

External grooving and threading toolholder

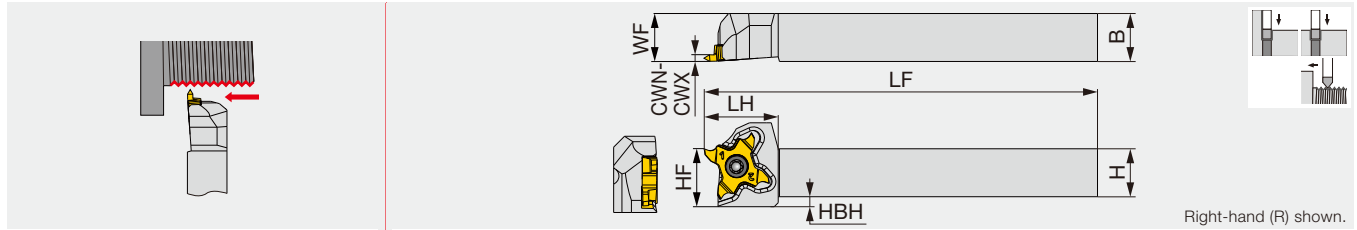

Right-hand (R) shown.

Designation	Pitch	H	B	LF	LH	HF	WF	HBH	Insert	Torque*
STCR/L1010X18	0.4 - 3	10	10	120	18.5	10	10	4.5	TC*18...	1.2
STCR/L1212F18	0.4 - 3	12	12	85	18.5	12	12	2.5	TC*18...	1.2
STCR/L1212X18	0.4 - 3	12	12	120	18.5	12	12	2.5	TC*18...	1.2
STCR/L1616X18	0.4 - 3	16	16	120	18.5	16	16	-	TC*18...	1.2
STCR/L2020H18	0.4 - 3	20	20	100	18.5	20	20	-	TC*18...	1.2
STCR/L2020X18	0.4 - 3	20	20	120	23.0	20	25	-	TC*18...	1.2

Torque*: Recommended torque (N-m) for clamping

The right hand insert (TC*18R...) is used for the right hand toolholders (STCR...), and the left hand insert (TC*18L...) is used for the left hand toolholders (STCL...).



STCR/L-H/X18-CHP

Direct connection

External grooving and threading toolholder, high pressure coolant compatible

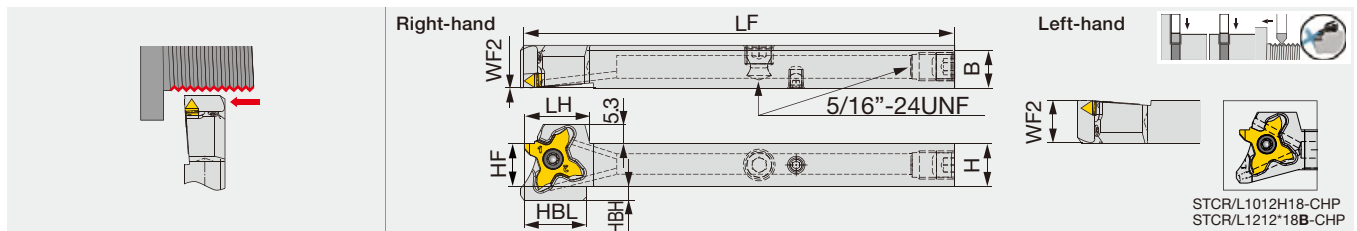

STCR/L1012H18-CHP
STCR/L1212*18B-CHP

Designation	Pitch	H	B	LF	LH	HBL	HF	WF	HBH	Insert	Torque*
STCR/L1012H18-CHP	0.4 - 3	10	12	100	17.1	17.1	10	0/12	4	TC**18	1.2
STCR/L1212X18B-CHP	0.4 - 3	12	12	120	18.5	17.5	12	0/12	4	TC**18	1.2
STCR/L1616X18-CHP	0.4 - 3	16	16	120	18.5	-	16	0/16	0	TC**18	1.2

Torque*: Recommended torque (N-m) for clamping

The right hand insert (TC*18R...) is used for the right hand toolholders (STCR...), and the left hand insert (TC*18L...) is used for the left hand toolholders (STCL...).

SPARE PARTS

Designation	Clamping screw	Wrench	Coolant plug	Wrench	DirectJet plug	Wrench
STCR...18	CSTC-4L100DL	T-1008/5	-	-	-	-
STCL...18	CSTC-4L100DR	T-1008/5	-	-	-	-
STCL**18-CHP	CSTC-4L100DR	T-1008/5	SR5/16UNFTL360	P-4	SSHM4-6-TB	P-2
STCR**18-CHP	CSTC-4L100DL	T-1008/5	SR5/16UNFTL360	P-4	SSHM4-6-TB	P-2

Reference pages : STCR/L-18, STCR/L-H/X18-CHP: Inserts → **G156, G157**, Standard cutting conditions → **G157**

External grooving and threading toolholder. High pressure coolant capability.

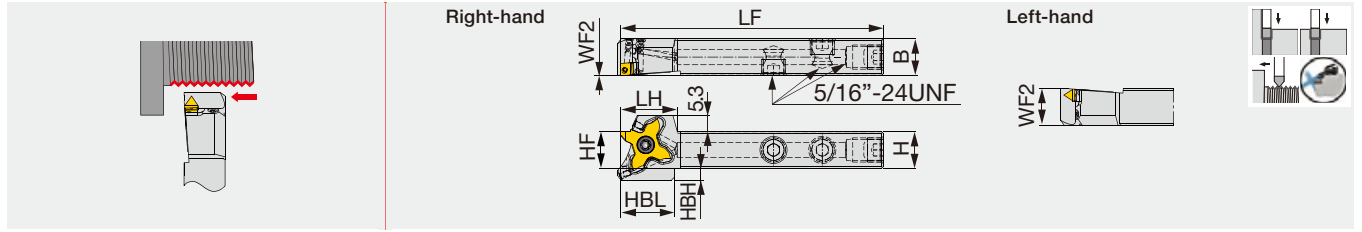

Designation	Pitch	H	B	LF	LH	HBL	HF	WF	HBH	Insert	Torque*
STCR/L1212F18B-CHP	0.4 - 3	12	12	85	18.5	17.5	12	0/12	4	TC**18	1.2

• The right hand insert (TC*18R***) is used for the right hand toolholders (STCR***), and the left hand insert (TC*18L***) is used for the left hand toolholders (STCL***).
 (1) *0/12" for the WF dimension indicates WF = 0 for the right handed tool, WF = 12 for the left handed tool.
 Torque*: Recommended torque (N-m) for clamping
 ***: To be replaced with the new design

JS-STCL18

External grooving and threading toolholder with round shank, for Swiss lathes

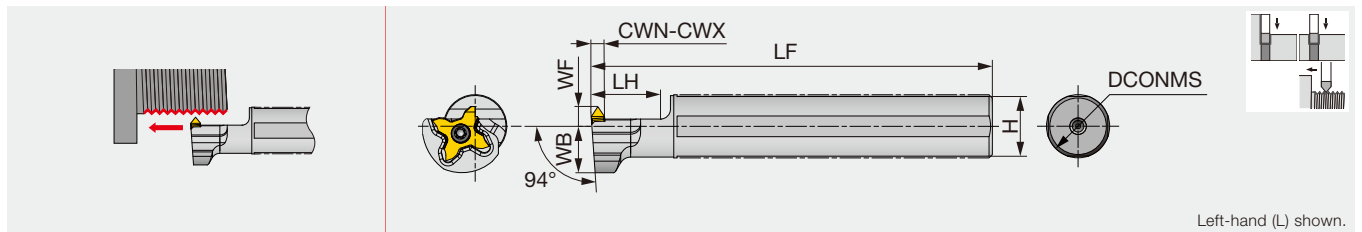

Designation	Pitch	DCONMS	H	LF	LH	WB	WF	Insert	Torque*
JS14H-STCL18	0.4 - 3	14	13	100	20	14	6	TC*18R...	1.2
JS159F-STCL18	0.4 - 3	15.875	15	85	20	14	6	TC*18R...	1.2
JS16F-STCL18	0.4 - 3	16	15	85	20	14	6	TC*18R...	1.2
JS19G-STCL18	0.4 - 3	19.05	18	90	20	14	6	TC*18R...	1.2
JS19X-STCL18	0.4 - 3	19.05	18	120	20	14	6	TC*18R...	1.2
JS20G-STCL18	0.4 - 3	20	19	90	20	14	6	TC*18R...	1.2
JS20X-STCL18	0.4 - 3	20	19	120	20	14	6	TC*18R...	1.2
JS22X-STCL18	0.4 - 3	22	21	120	20	12.25	10	TC*18R...	1.2
JS25H-STCL18	0.4 - 3	25	24	100	20	12.25	10	TC*18R...	1.2
JS254X-STCL18	0.4 - 3	25.4	24	120	20	12.25	10	TC*18R...	1.2

- The left hand toolholder (STCL...) is used with the right hand inserts (TC*18R...)
 Torque*: Recommended torque (N-m) for clamping

SPARE PARTS

Designation	Clamping screw	Wrench	Coolant plug	Wrench
STCL**18-CHP	CSTC-4L100DR	T-1008/5	SR5/16UNFTL360	P-4
STCR**18-CHP	CSTC-4L100DL	T-1008/5	SR5/16UNFTL360	P-4
JS...STCL18	CSTC-4L100DL	T-1008/5	-	-

Grade
Insert
Ext. Toolholder
Int. Toolholder
Threading
Grooving
Miniature tool
Milling cutter
Endmill
Drilling tool
Tooling System
User's Guide
Index

A
B
C
D
E
F
G
H
I
J
K
L
M

INSERT

TCT18FR/R-ISO (Full profile threading insert)

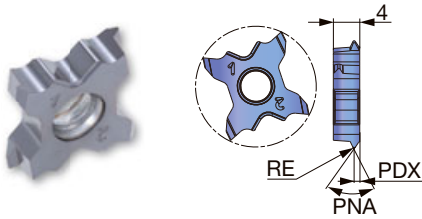

Right-hand (R) shown.

P	Steel	★	★					
M	Stainless	★	★					
K	Cast iron	★	★					
N	Non-ferrous							
S	Superalloys	★	★					
H	Hard materials							

★ : First choice
☆ : Second choice

Designation	HAND	RE	Coated		Pitch min	Pitch max	PDX	PNA
			SH725	AH725				
TCT18FR-05ISO	R	0.06	●		0.5		0.35	60°
TCT18FR-07ISO	R	0.09	●		0.7		0.45	60°
TCT18FR-075ISO	R	0.09	●		0.75		0.5	60°
TCT18FR-08ISO	R	0.1	●		0.8		0.5	60°
TCT18R-10ISO	R	0.13		●	1		0.6	60°
TCT18R-125ISO	R	0.17		●	1.25		0.7	60°
TCT18R-15ISO	R	0.2		●	1.5		0.8	60°

● : Line up

TCT18R/L (for threading)

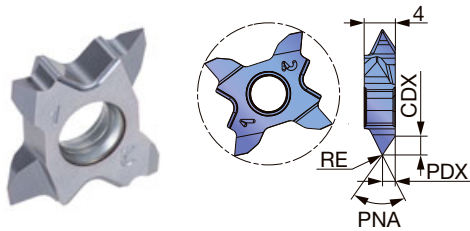

P	Steel	★						
M	Stainless	★						
K	Cast iron	★						
N	Non-ferrous							
S	Superalloys	★						
H	Hard materials							

★ : First choice
☆ : Second choice

Designation	HAND	RE	Coated		Pitch min	Pitch max	PDX	CDX	PNA
			AH725						
TCT18R-60N-010	R	0.1	●		0.8	3	1.6	2.67	60°
TCT18L-60N-010	L	0.1	●		0.8	3	1.6	2.67	60°
TCT18R-60N-020	R	0.2	●		1.5	3	1.6	2.57	60°
TCT18L-60N-020	L	0.2	●		1.5	3	1.6	2.57	60°

● : Line up

Reference pages: Toolholder → [G152 - G155](#)

TCT18FR (sharp edge for threading)

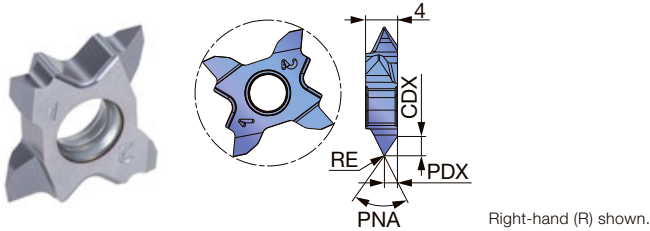

P	Steel	★							
M	Stainless	★							
K	Cast iron	★							
N	Non-ferrous								
S	Superalloys	★							
H	Hard materials								

★ : First choice
☆ : Second choice

Designation	HAND	RE	Coated							Pitch min	Pitch max	PDX	CDX	PNA
			SH725											
TCT18FR-60A-005	R	0.05	●							0.4	1	0.6	0.99	60°
TCT18FR-60A-010	R	0.1	●							1	2	1	1.63	60°

● : Line up

STANDARD CUTTING CONDITIONS

TCT18FR/R-ISO (Full profile threading insert) / TCT18FR (Threading insert)

ISO	Workpiece materials	Priority	Grades	Cutting speed Vc (m/min)	Pitch (mm)	TPI
P	Low carbon steel S15C, S20C, etc. C15, C20, etc.	First choice	SH725	60 - 150	0.4 - 2.0	64 - 18
		Toughness	AH725	60 - 150	0.8 - 3.0	32 - 8
	Carbon steels, Alloy steel S55C, SCM440, etc. C55, 42CrMoS4, etc.	First choice	SH725	60 - 150	0.4 - 2.0	64 - 18
		Toughness	AH725	60 - 150	0.8 - 3.0	32 - 8
M	Prehardened steel NAK80, PX5, etc.	First choice	SH725	60 - 150	0.4 - 2.0	64 - 18
		Toughness	AH725	60 - 150	0.8 - 3.0	32 - 8
	Stainless steel SUS304, etc. X5CrNi18-9, etc.	First choice	SH725	50 - 80	0.4 - 2.0	64 - 18
		Toughness	AH725	50 - 80	0.8 - 3.0	32 - 8
K	Grey cast iron FC250, FC300, etc. 250, 300, etc.	First choice	AH725	50 - 100	0.8 - 3.0	32 - 8
		Sharpness	SH725	50 - 100	0.4 - 2.0	64 - 18
	Ductile cast iron FCD400, FCD600, etc. 400-15, 600-3, etc.	First choice	AH725	50 - 100	0.8 - 3.0	32 - 8
		Sharpness	SH725	50 - 100	0.4 - 2.0	64 - 18
S	Titanium alloys Ti-6Al-4V, etc.	First choice	SH725	30 - 100	0.4 - 2.0	64 - 18
		Toughness	AH725	30 - 100	0.8 - 3.0	32 - 8
	Superalloys Inconel718, etc.	First choice	SH725	30 - 100	0.4 - 2.0	64 - 18
		Toughness	AH725	30 - 100	0.8 - 3.0	32 - 8



Parting toolholder, for Swiss lathes

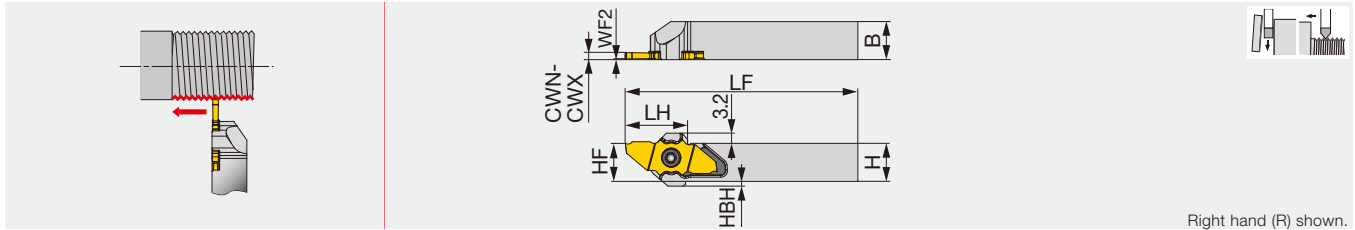

Designation	CWN	CWX	H	B	LF**	LH**	HF	WF2	HBL**	HBH	Insert	Torque*
JSXXR/L1010X09	0.6	2.5	10	10	120	19.65	10	0.2	19	3	JX**06...,12...,16...,20...	1.2
JSXXR/L1212F09	0.6	2.5	12	12	85	19.65	12	0.2	19	1.5	JX**06...,12...,16...,20...	1.2
JSXXR/L1212X09	0.6	2.5	12	12	120	19.65	12	0.2	19	1.5	JX**06...,12...,16...,20...	1.2
JSXXR/L1616X09	0.6	2.5	16	16	120	19.65	16	0.2	-	-	JX**06...,12...,16...,20...	1.2
JSXXR/L2020H09	0.6	2.5	20	20	100	22.5	20	0.2	-	-	JX**06...,12...,16...,20...	1.2

Torque*: Recommended torque (N-m) for clamping

**LF (Functional Length) LH (Head Length), and HBL (Head-bottom Offset Length) values shown above are true with JXPG16... insert. LF, LH, and HBL will all be 2 mm shorter than the above values with JX*G12... and JXPG20... inserts, and 4 mm shorter for JXPG06... insert.

Note: Use the right-hand insert (JX***R...) for a right-hand holder (JSXXR...); the left-hand insert (JX***L...) for a left-hand holder (JSXXL...).



JSXXR/L-S

Parting toolholder, for Swiss lathes (for sub spindle)

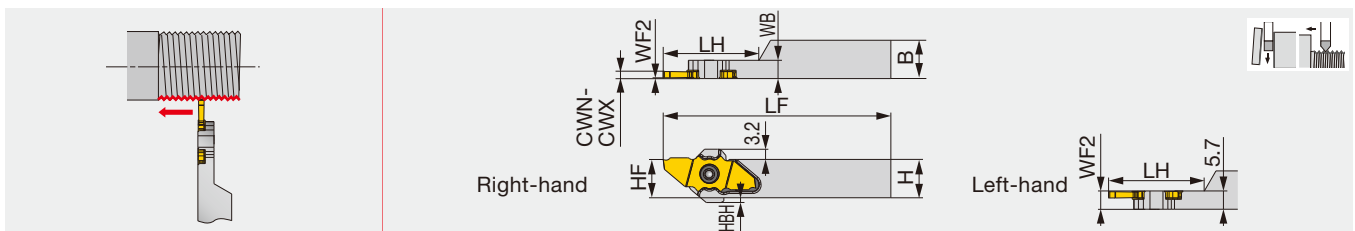

Designation	CWN	CWX	H	B	LF**	LH**	HF	WF2	HBH	Insert	Torque*
JSXXR/L1010X09-S	0.6	2.5	10	10	120	26	10	0.2/5.5	3	JX**06...,12...,16...	1.2
JSXXR/L1212F09-S	0.6	2.5	12	12	85	26	12	0.2/5.5	1.5	JX**06...,12...,16...	1.2
JSXXR/L1212X09-S	0.6	2.5	12	12	120	30	12	0.2/5.5	1.5	JX**06...,12...,16...	1.2
JSXXR/L1616X09-S	0.6	2.5	16	16	120	30	16	0.2/5.5	-	JX**06...,12...,16...,20...	1.2

Torque*: Recommended torque (N-m) for clamping

**LF (Functional Length) and LH (Head Length) values shown above are true with JXPG16... insert. LF and LH will be 2 mm shorter than the above values with JX*G12... insert, and 4 mm shorter for JXPG06... insert. LF, LH, and HBL will all be 2 mm shorter with JXPG20... insert.

***JXPG20... insert will not fit.

Note: Use the right-hand insert (JX***R...) for a right-hand holder (JSXXR...); the left-hand insert (JX***L...) for a left-hand holder (JSXXL...).

SPARE PARTS



Designation	Clamping screw	Wrench
JSXXR..., JSXXR****09-S	CSTC-4L055DL	T-1008/5
JSXXL..., JSXXL****09-S	CSTC-4L055DR	T-1008/5

JSXXR/L-F/H/X-CHP

Parting-off toolholders with high pressure coolant capability, for swiss lathes

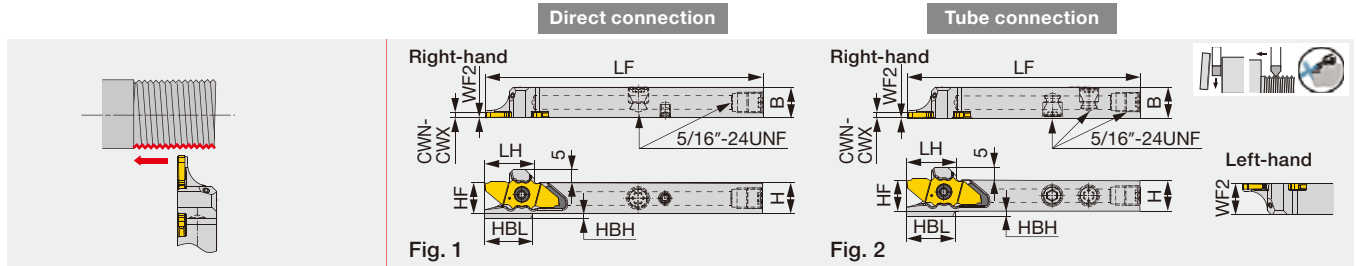

Designation	CWN	CWX	H	B	LF ⁽¹⁾	LH ⁽¹⁾	HF	WF2 ⁽²⁾	HBL ⁽¹⁾	HBH	Insert	Torque*	Fig.
JSXXR/L1012H09-CHP ⁽³⁾	0.6	2.5	10	12	102	19.2	10	0.2/11.8	18.7	3	JX**06...,12...,16..., 20...	1.2	1
JSXXR/L1212F09-CHP	0.6	2.5	12	12	85	19.4	12	0.2/11.8	18.8	2	JX**06...,12...,16..., 20...	1.2	2
JSXXR/L1212X09-CHP ⁽³⁾	0.6	2.5	12	12	120	19.4	12	0.2/11.8	18.8	2	JX**06...,12...,16..., 20...	1.2	1
JSXXR/L1616X09B-CHP ⁽³⁾	0.6	2.5	16	16	120	19.4	16	0.2/15.8	18.7	-	JX**06...,12...,16..., 20...	1.2	1

Torque*: Recommended clamping torque (N·m)
 (1) LF (Functional Length) LH (Head Length), and HBL (Head-bottom Offset Length) values shown above are true with JX**16... insert. LF, LH, and HBL will all be 2 mm shorter than the above values with JX**12... and JX**20... inserts, and 4 mm shorter for JX**06... insert.
 (2) The first value before "/" indicates the WF for the right-hand holder and the second value after "/" for the left-hand holder.
 (3) Compatible to the direct internal coolant supply system without the use of external coolant hose.
 (4) To be replaced with the new design
 Note: Use the right-hand insert (JX**R...) for a right-hand holder (JSXXR...); the left-hand insert (JX**L...) for a left-hand holder (JSXXL...).

JSXXR/L-F/X-S-CHP

Parting-off toolholders with high pressure coolant capability, for swiss lathes (for sub spindle)

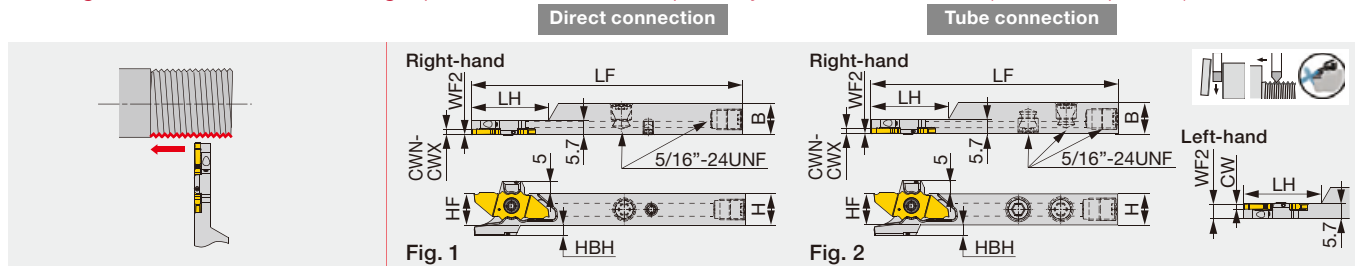

Designation	CWN	CWX	H	B	LF ⁽¹⁾	LH ⁽¹⁾	HF	WF2 ⁽²⁾	HBH	Insert	Torque*	Fig.
JSXXR/L1212F09-S-CHP ⁽⁴⁾	0.6	2.5	12	12	85	26	12	0.2	4	JX**06...,12...,16..., 20...	1.2	2
JSXXR/L1212F09B-S-CHP	0.6	2.5	12	12	85	30	12	0.2/5.5	2	JX**06...,12...,16..., 20...	1.2	2
JSXXR/L1212X09-S-CHP ^{(3),(4)}	0.6	2.5	12	12	120	30	12	0.2/5.5	4	JX**06...,12...,16..., 20...	1.2	1
JSXXR/L1212X09B-S-CHP ⁽³⁾	0.6	2.5	12	12	120	30	12	0.2/5.5	2	JX**06...,12...,16..., 20...	1.2	1
JSXXR/L1616X09-S-CHP ^{(3),(4)}	0.6	2.5	16	16	120	30	16	0.2	1.5	JX**06...,12...,16..., 20...	1.2	1
JSXXR/L1616X09B-S-CHP ⁽³⁾	0.6	2.5	16	16	120	30	16	0.2/5.5	-	JX**06...,12...,16..., 20...	1.2	1

Torque*: Recommended clamping torque (N·m)
 (1) LF (Functional Length) and LH (Head Length) values shown above are true with JX**16... insert. Both LF and LH will be 2 mm shorter than the above value with JX**12... and JX**20... inserts; 4 mm shorter with JX**06... insert.
 (2) The first value before "/" indicates the WF for the right-hand holder and the second value after "/" for the left-hand holder.
 (3) Compatible to the direct internal coolant supply system without the use of external coolant hose.
 (4) To be replaced with the new design
 Note: Use the right-hand insert (JX**R...) for a right-hand holder (JSXXR...); the left-hand insert (JX**L...) for a left-hand holder (JSXXL...).

SPARE PARTS						
Designation	Clamping screw	Wrench 1	Coolant plug	Wrench 2	DirectJet plug	Wrench 3
JSXXR**F...	CSTC-4L100DL	T-1008/5	SR5/16UNFTL360	P-4	-	-
JSXXL**F...	CSTC-4L100DR	T-1008/5	SR5/16UNFTL360	P-4	-	-
JSXXR**H/X...	CSTC-4L100DL	T-1008/5	SR5/16UNFTL360	P-4	SSHM4-6-TB	P-2
JSXXL**H/X...	CSTC-4L100DR	T-1008/5	SR5/16UNFTL360	P-4	SSHM4-6-TB	P-2

Reference pages: JSXXR/L-F/H/X-CHP, JSXXR/L-F/X-S-CHP:
 Inserts → **G160**, Standard cutting conditions → **G161**

Grade
 Insert
 Ext. Toolholder
 Int. Toolholder
 Threading
 Grooving
 Miniature tool
 Milling cutter
 Endmill
 Drilling tool
 Tooling System
 User's Guide
 Index

Round shanks, for threading

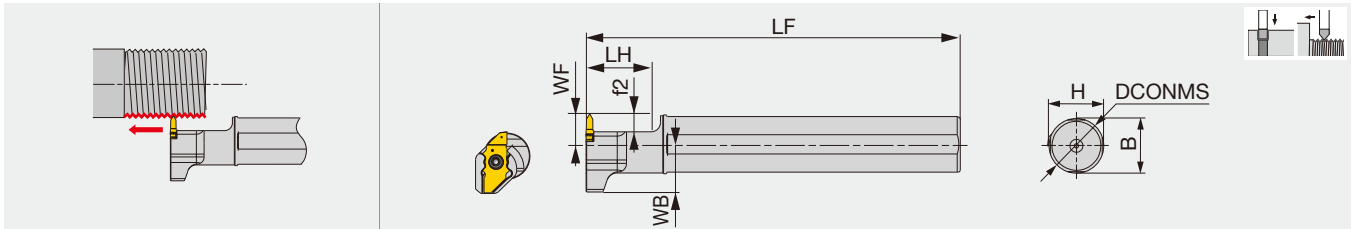

Designation	DCONMS	H	B	LF	LH	WB	WF ⁽¹⁾	f2 ⁽¹⁾	Insert	Torque*
JS19G-SXXL09	19.05	18	18	90	21	15.43	10	6	JX**06,12*R	1.2
JS19X-SXXL09	19.05	18	18	120	21	15.43	10	6	JX**06,12*R	1.2
JS20G-SXXL09	20	19	19	90	21	15.4	10	6	JX**06,12*R	1.2
JS20X-SXXL09	20	19	19	120	21	15.4	10	6	JX**06,12*R	1.2
JS22X-SXXL09	22	21	21	120	21	15.4	10	6	JX**06,12*R	1.2
JS25H-SXXL09	25	24	24	100	21	15.4	10	6	JX**06,12*R	1.2
JS254X-SXXL09	25.4	24	24	120	21	15.4	10	6	JX**06,12*R	1.2

Torque*: Recommended clamping torque (N·m)

(1) When using JX..06... insert, both WF and f2 sizes will be 2 mm shorter than the values provided above.

SPARE PARTS

Designation	Clamping screw	Wrench
JS***-SXXL09	CSTC-4L100DL	T-1008/5

INSERT

JXTG12FR/L-60 (For Threading / Sharp edge)

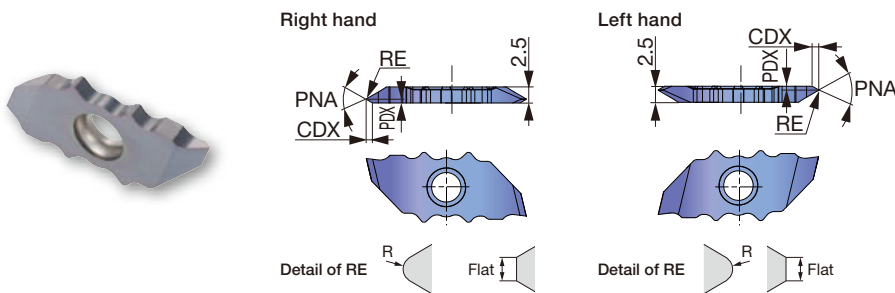

P Steel	★						
M Stainless	★						
K Cast iron	★						
N Non-ferrous	★						
S Superalloys	★						
H Hard materials	★						

★ : First choice

Designation	HAND	RE	Coated				Pitches	PDX	CDX	PNA
			SH725							
JXTG12FR-60A-000	R	Flat 0.05 max	●				0.2 - 0.4	0.25	0.4	60°
JXTG12FL-60A-000	L	Flat 0.05 max	●				0.2 - 0.4	0.25	0.4	60°
JXTG12FR-60B-000	R	Flat 0.05 max	●				0.2 - 0.4	0.25	0.4	60°
JXTG12FL-60B-000	L	Flat 0.05 max	●				0.2 - 0.4	0.25	0.4	60°
JXTG12FR-60A-005	R	R 0.05	●				0.4 - 1	0.6	0.99	60°
JXTG12FL-60A-005	L	R 0.05	●				0.4 - 1	0.6	0.99	60°
JXTG12FR-60B-005	R	R 0.05	●				0.4 - 1	1.9	0.99	60°
JXTG12FL-60B-005	L	R 0.05	●				0.4 - 1	1.9	0.99	60°
JXTG12FR-60N-010	R	R 0.1	●				1 - 1.5	1.25	2.07	60°
JXTG12FL-60N-010	L	R 0.1	●				1 - 1.5	1.25	2.07	60°

● : Line-up

Reference pages: Toolholder → **G158 - G160**

STANDARD CUTTING CONDITIONS

ISO	Workpiece materials	Grades	Cutting speed Vc (m/min)
P	Low carbon steels S15C, SS400, etc. C15E4, E275A, etc.	SH725	50 - 200
	Carbon steels, Alloy steels S55C, SCM440, etc. C55, 42CrMo4, etc.	SH725	50 - 200
	Free cutting steels SUH22, SUH23, etc.	SH725	50 - 200
M	Stainless steels SUS304, X5CrNi18-9, etc.	SH725	50 - 200
N	Aluminium alloys A5056, A6061, etc.	SH725	150 - 200
	Copper alloy C2600, C280C, etc.	SH725	100 - 200
S	Titanium alloys Ti-6Al-4V, etc.	SH725	30 - 80
	Superalloys Inconel718, etc.	SH725	30 - 80

Grade

A

Insert

B

Ext. Toolholder

C

Int. Toolholder

D

Threading

E

Grooving

F

Miniature tool

G

Milling cutter

H

Endmill

I

Drilling tool

J

Tooling System

K

User's Guide

L

Index

M

Screw-on external threading toolholders-High-pressure coolant capability with tube and direct connection

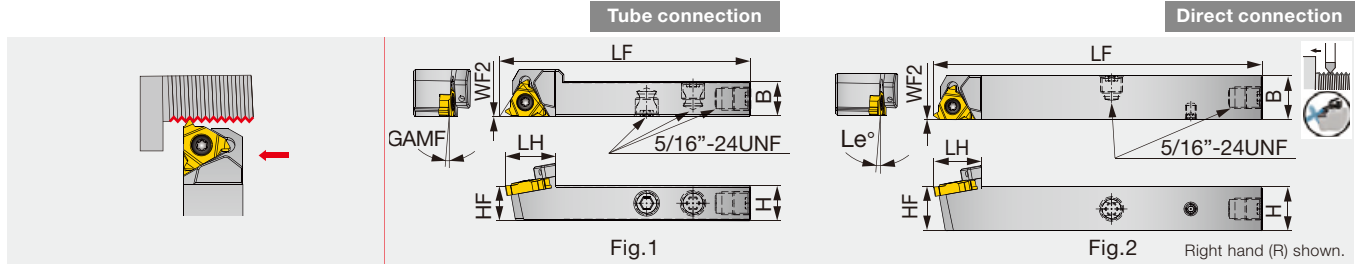

Designation	H	B	LF	LH	HF	WF2	GAMF	Insert	Fig.
JSE2R1212F16-CHP	12	12	85	19	12	0	1°	16ER...	1
JSE2R1212X16-CHP	12	12	120	19	12	0	1°	16ER...	2
JSE2R1616X16-CHP	16	16	120	19	16	0	1°	16ER...	2

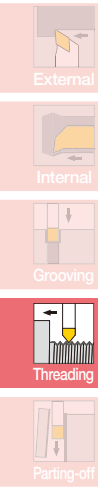

SER-X-CHP-MC

Screw-on external threading toolholders-High-pressure coolant capability with tube and direct connection

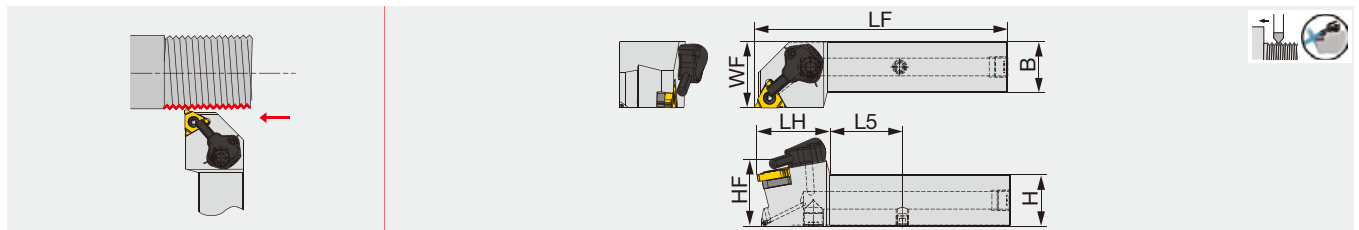

Designation	H	B	LF	LH	HF	WF	L5	Insert
SER2020X16-CHP-MC	20	20	107	36	20	25	27.9	16ER...

SPARE PARTS

Designation	Clamping screw	Wrench	Shim screw	Shim	Coolant unit	Coolant plug	Wrench
JSE2R**16-CHP	CSTB-3.5	T-15F	-	-	-	SR5/16UNFTL360	P-4
SER**X16-CHP-MC	CSTB-3.5ST	T-15F	DTS5-3.5	A16-1DT	CU-V-CHP	PLUGG1/8-6.5TL360	P-3.5
SER**X22-CHP-MC	CSTB-4ST	T-15F	DTS6-4	GX22-1DT	CU-CW-CHP	PLUGG1/8-6.5TL360	P-4

No need for coolant tube setup.
Eliminates chip entanglement on tubes and streamlines tool replacement.

Coolant is supplied from the tool post directly to the tools

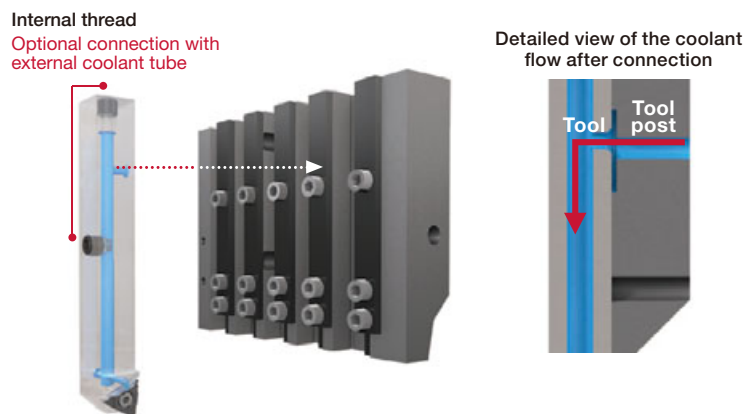

JS-SEL16

External threading toolholder, for Swiss lathes

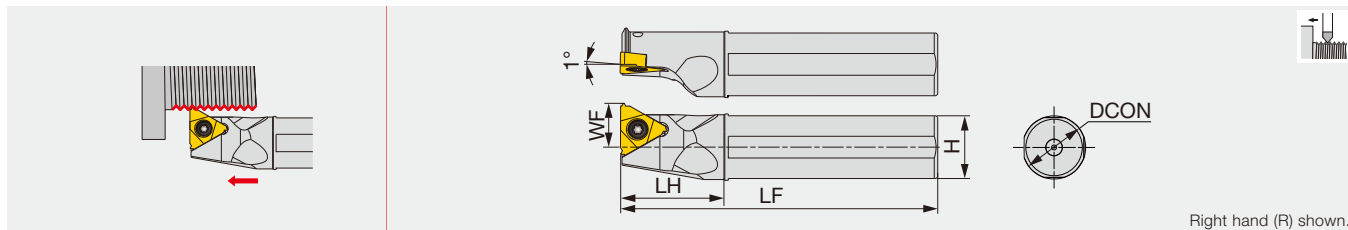

Designation	DCON	H	LF	LH	WF	Insert
JS16F-SEL16	16	15	85	25	11	16ER...
JS19G-SEL16	19.05	18	90	30	12.5	16ER...
JS19X-SEL16	19.05	18	120	30	12.5	16ER...
JS20G-SEL16	20	19	90	30	13	16ER...
JS20X-SEL16	20	19	120	30	13	16ER...
JS25H-SEL16	25	24	100	30	15.5	16ER...
JS254X-SEL16	25.4	24	120	30	15.7	16ER...

Note: Use left-hand toolholders (L) with right-hand inserts (R).

B-S/CER/L

External threading toolholder, for Swiss lathes

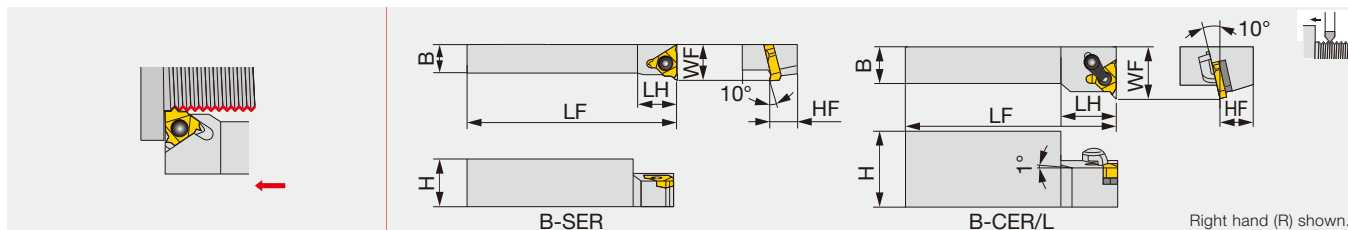

Designation	H	B	LF	LH	HF	WF	Insert
B-SER10H16	20	10	100	15	10	16	16ER...
B-SER12K16	24	12	125	18	12	18	16ER...
B-CER/L16M16	32	16	150	24	16	22	16ER/L...

BC-SER/L

External threading toolholder, for multi-functional Swiss lathes

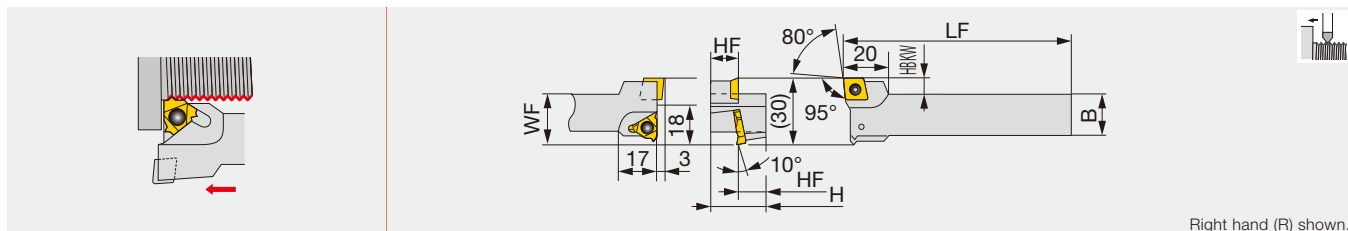

Designation	H	B	LF	HF	WF	HBKW	Insert
BC-SER12K16	24	16	125	12	23	7	16ER..., CC*T09T3...

SPARE PARTS

Designation	Clamp set	Shim set	Clamping screw	Wrench
JS***-SEL16, B-SER***16, BC-SER12K16	-	-	CSTB-3.5	T-15F
B-CER/L16M16	CSP16	A16-1	-	T-15F

Reference pages: JS-SEL16, B-S/CER/L: Inserts → **E010** -, Standard cutting conditions → **E067**
 BC-SER/L: Inserts → **B112** - (CC*T09T3...), **E010** - (16ER...),
 Standard cutting conditions → **E067**

SER

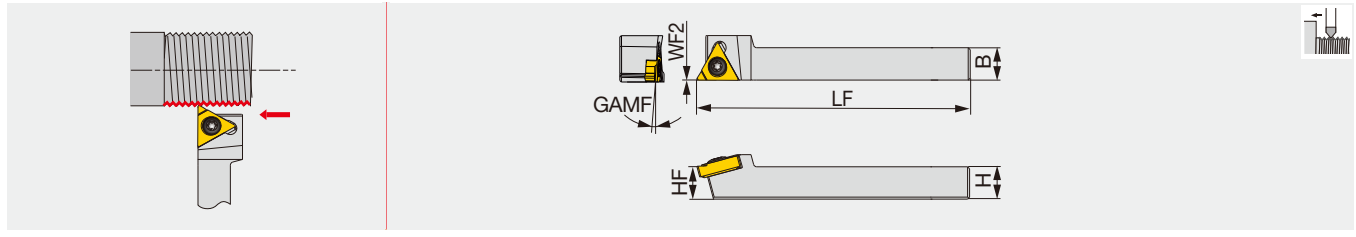

Designation	H	B	LF	HF	WF2	GAMF	Insert
SER0808H11	8	8	100	8	0	1.5°	11ER...
SER1010H11	10	10	100	10	0	1.5°	11ER...

J-SERIES

JSXBR/L

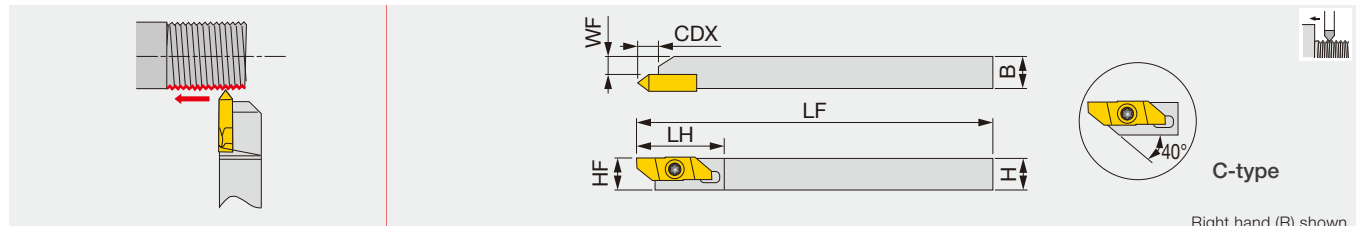

Designation	H	B	LF	LH	CDX	HF	WF	Insert
JSXBR/L1010K8-C	10	10	125	29	6.7	10	5.7	JXT*R...
JSXBR/L1212K8-C	12	12	125	29	6.7	12	7.7	JXT*R...
JSXBR/L1616K8	16	16	125	29	6.4	16	11.7	JXT*R...
JSXBR/L2020K8	20	20	125	29	6.4	20	15.7	JXT*R...
JSXBR/L2525K8	25	25	125	29	6.4	25	20.7	JXT*R...

Can be wrenched from back side with both end torx screw.
This toolholder is compatible with JXB-type inserts and JXT-type inserts.

Spare Parts	Clamping screw	Wrench 1	Wrench 2 (Optional)
SER**H11	SR M2.6-L6.7-S11	T-8/5	-
JSXBR...	CSTB-4SD	T-8F	(T-8L)

INSERT

JXT (sharp edge)

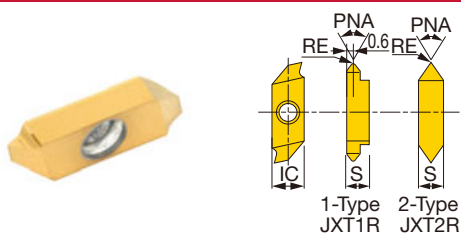

Material	1-Type JXT1R	2-Type JXT2R	Legend
P Steel	★		★ : First choice ☆ : Second choice
M Stainless	★		
K Cast iron			
N Non-ferrous		☆	
S Superalloys	☆	☆	
H Hard materials		☆	

Designation	RE	Coated		Uncoated		PNA	IC	S
		J740	TH10					
JXT1R6000F	0.03	●	●			60°	8	3.97
JXT2R6000F	0.03	●	●			60°	8	3.97

Machinable pitch range: 0.5 to 1 mm ● : Line up

Reference pages: SER: Inserts → E010 -, Standard cutting conditions → E067

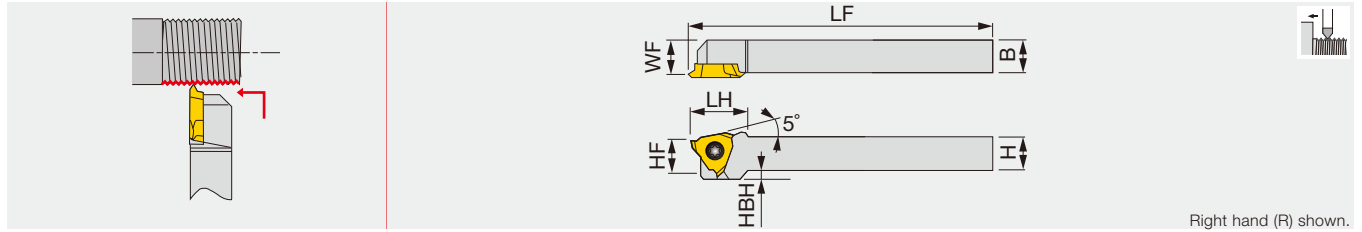

Right hand (R) shown.

Designation	H	B	LF	LH	HF	WF	HBH	Insert
JSTTR/L1010X3	10	10	120	18.5	10	9.5	2	JTTR/L3...
JSTTR/L1212F3	12	12	85	18.5	12	11.5	-	JTTR/L3...
JSTTR/L1212X3	12	12	120	18.5	12	11.5	-	JTTR/L3...
JSTTR/L1616X3	16	16	120	18.5	16	15.5	-	JTTR/L3...

Recommended clamping torque: 1.2 N·m

JS-TTL3

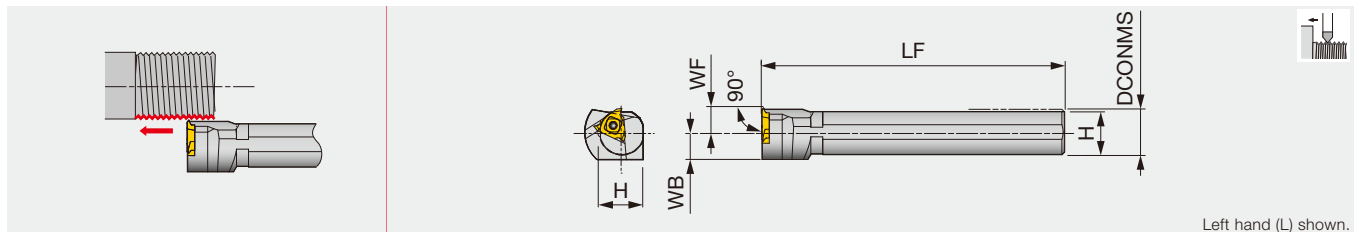

Left hand (L) shown.

Designation	DCONMS	WF	LF	H	WB	Insert
JS19K-TTL3	19.05	10	125	18	11.5	JTTR30...
JS20K-TTL3	20	10	125	19	11.5	JTTR30...
JS22K-TTL3	22	10	125	21	11.5	JTTR30...
JS25K-TTL3	25.4	10	125	24	12.7	JTTR30...

Recommended clamping torque: 3.5 N·m

SPARE PARTS

Designation	Clamping screw	Wrench 1	Wrench 2 (Optional)
JSTTR/L...	CSTB-4SD	T-8F	(T-8L)
JS**-TTL3	CSTB-4S	T-15F	-

INSERT

JTT (sharp edge)

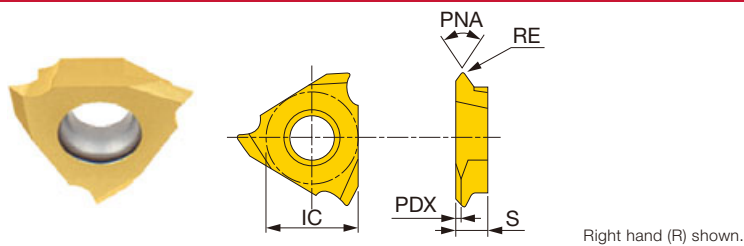

P	Steel	★	☆		★								
M	Stainless	★	☆										
K	Cast iron	★			☆		★						
N	Non-ferrous						★						
S	Superalloys	☆					★						
H	Hard materials	☆					★						

★ : First choice
☆ : Second choice

Designation	RE	Coated		Cermet	Uncoated	PNA	IC	S	PDX
		SH725	J740	NS9530	TH10				
JTTR3005F-55	0.05	●	●			55°	9.525	3.18	0.6
JTTL3005F-55	0.05					55°	9.525	3.18	0.6
JTTR3005F	0.05	●	●	●	●	60°	9.525	3.18	0.9
JTTL3005F	0.05	●	●		●	60°	9.525	3.18	0.9
JTTR3010F	0.1	●	●	●	●	60°	9.525	3.18	0.9
JTTL3010F	0.1	●				60°	9.525	3.18	0.9

Machinable pitch range: 0.5 to 1 mm

● : Line up

STANDARD CUTTING CONDITIONS

ISO	Workpiece material	Grade	Cutting speed Vc (m/min)	Pitch (mm)	TPI
P	Low carbon steel S15C, S25C, etc. C15, C25, etc.	SH725	60 - 150	0.5 - 1	50 - 25
	Carbon steel, Alloy steel S55C, SCM440 etc. C55, 42CrMoS4, etc.	SH725	60 - 150	0.5 - 1	50 - 25
	Pre-hardened steel NAK80, PX5 etc.	SH725	60 - 150	0.5 - 1	50 - 25
M	Stainless steel SUS304, SUS316 etc. X5CrNi18-9, X5CrNiMo17-12-2, etc.	SH725	50 - 80	0.5 - 1	50 - 25
K	Grey cast iron FC250, FC300, etc. 250, 300, etc.	TH10	50 - 100	0.5 - 1	50 - 25
	Ductile cast iron FCD400, etc. 400-15S, etc.	TH10	50 - 100	0.5 - 1	50 - 25
S	Titanium alloy Ti-6Al-4V, etc.	SH725	30 - 100	0.5 - 1	50 - 25
	Heat resistant alloy Inconel 718, etc.	SH725	30 - 100	0.5 - 1	50 - 25

Reference pages: Toolholder → **G165**

Parting-off and front turning toolholders

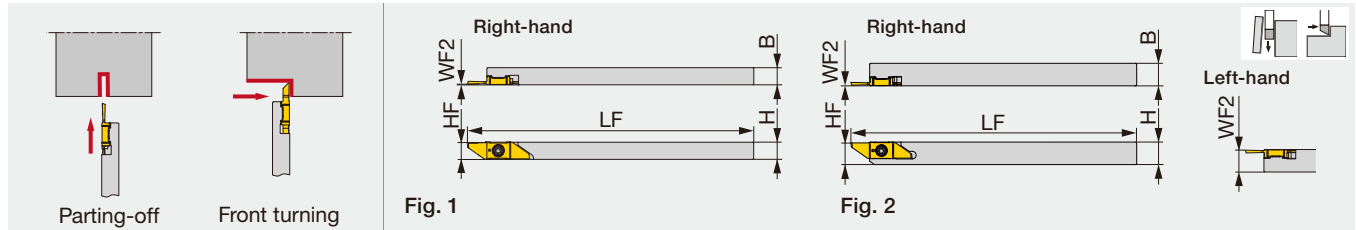

Designation	H	B	LF	HF	WF2 ⁽¹⁾	Insert	Torque*	Fig.
JSXXL0606X05	6	6	120	5.6	5.8	JV*N..., JVN...	1.3	1
JSXXR/L0707X05	7	7	120	6.6	0.2/6.8	JV*N..., JVN...	1.3	1
JSXXR/L0808F05	8	8	85	7.7	0.2/7.8	JV*N..., JVN...	1.3	2
JSXXR/L0808H05	8	8	100	7.7	0.2/7.8	JV*N..., JVN...	1.3	2
JSXXR/L1010H05	10	10	100	9.7	0.2/9.8	JV*N..., JVN...	1.3	2

Torque*: Recommended clamping torque (N·m)

(1) The first value before “/” indicates the WF for the right-hand holder and the second value after “/” for the left-hand holder.

Use the right-hand insert (JV****R...) for a right-hand holder (JSXXR...); the left-hand insert (JV****L...) for a left-hand holder (JSXXL...).

SPARE PARTS



Designation	Clamping screw	Wrench
JSXXR...05	CSTB-2.5L054DL	T-7F
JSXXL...05	CSTB-2.5L054DR	T-7F

INSERTS

JVPN**R/L (For parting-off)

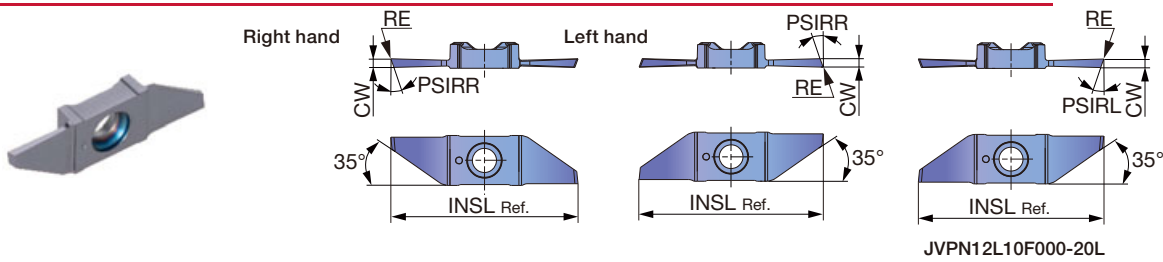

P	Steel	★					
M	Stainless	★					
K	Cast iron						
N	Non-ferrous	★					
S	Superalloys	★					
H	Hard materials						

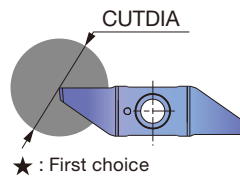

Designation	HAND	CW±0.025	RE	Coated				CUTDIA	INSL	PSIRR	PSIRL
				SH725							
JVPN04R05F000-20	R	0.5	0	●				4	42.8	20°	-
JVPN04L05F000-20	L	0.5	0	●				4	42.8	20°	-
JVPN04R05F005-20	R	0.5	0.05	●				4	42.6	20°	-
JVPN04L05F005-20	L	0.5	0.05	●				4	42.6	20°	-
JVPN07R06F000-20	R	0.6	0	●				7	42.8	20°	-
JVPN07L06F000-20	L	0.6	0	●				7	42.8	20°	-
JVPN07R06F005-20	R	0.6	0.05	●				7	42.8	20°	-
JVPN07L06F005-20	L	0.6	0.05	●				7	42.8	20°	-
JVPN12R08F000-20	R	0.8	0	●				12	43.2	20°	-
JVPN12L08F000-20	L	0.8	0	●				12	43.2	20°	-
JVPN12R08F005-20	R	0.8	0.05	●				12	43	20°	-
JVPN12L08F005-20	L	0.8	0.05	●				12	43	20°	-
JVPN12R10F000-20	R	1	0	●				12	43.4	20°	-
JVPN12L10F000-20	L	1	0	●				12	43.4	20°	-
JVPN12R10F005-20	R	1	0.05	●				12	43.4	20°	-
JVPN12L10F005-20	L	1	0.05	●				12	43.4	20°	-
JVPN12L10F000-20L	L	1	0	●				12	43.4	-	20°

● : Line up

Reference pages: JSXXR/L: Standard cutting conditions → G168



STANDARD CUTTING CONDITIONS

Parting-off

ISO	Workpiece materials	Grade	Cutting speed Vc (m/min)	Feed f (mm/rev)
P	Low carbon steels S15C, SS400, etc. C15E4, E275A, etc.	SH725	50 - 180	0.01 - 0.05
	Carbon steels, Alloy steels S55C, SCM440, etc. C55, 42CrMo4, etc.	SH725	50 - 180	0.01 - 0.05
	Free cutting steels SUH22, SUH23, etc.	SH725	50 - 180	0.01 - 0.05
M	Stainless steels SUS304, X5CrNi18-9, etc.	SH725	50 - 120	0.01 - 0.05
N	Aluminium alloys A5056, A6061, etc.	SH725	150 - 200	0.01 - 0.05
	Copper alloys C2600, C280C, etc.	SH725	100 - 200	0.01 - 0.05
S	Titanium alloys Ti-6Al-4V, etc.	SH725	30 - 80	0.01 - 0.05
	Superalloys Inconel718, etc.	SH725	30 - 80	0.01 - 0.05



External



Internal



Grooving



Threading



Parting-off

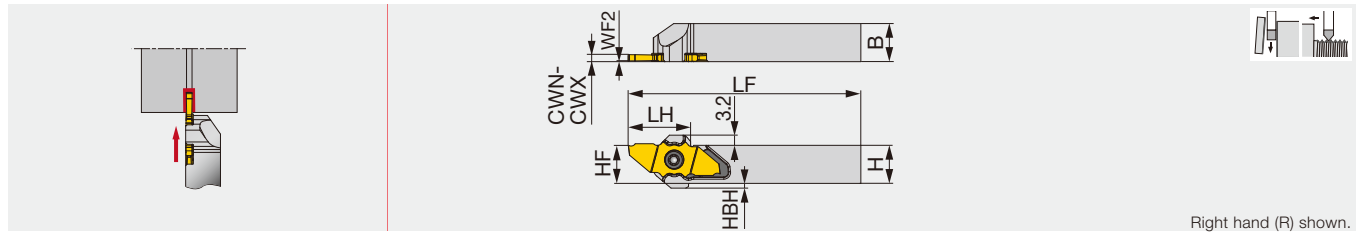

Designation	CWN	CWX	H	B	LF**	LH**	HF	WF2	HBL**	HBH	Insert	Torque*
JSXXR/L1010X09	0.6	2.5	10	10	120	19.65	10	0.2	19	3	JX**06...,12...,16...,20...	1.2
JSXXR/L1212F09	0.6	2.5	12	12	85	19.65	12	0.2	19	1.5	JX**06...,12...,16...,20...	1.2
JSXXR/L1212X09	0.6	2.5	12	12	120	19.65	12	0.2	19	1.5	JX**06...,12...,16...,20...	1.2
JSXXR/L1616X09	0.6	2.5	16	16	120	19.65	16	0.2	-	-	JX**06...,12...,16...,20...	1.2
JSXXR/L2020H09	0.6	2.5	20	20	100	22.5	20	0.2	-	-	JX**06...,12...,16...,20...	1.2

Torque*: Recommended torque (N-m) for clamping

**LF (Functional Length) LH (Head Length), and HBL (Head-bottom Offset Length) values shown above are true with JXPG16... insert. LF, LH, and HBL will all be 2 mm shorter than the above values with JX*G12... and JXPG20... inserts, and 4 mm shorter for JXPG06... insert.

Note: Use the right-hand insert (JX***R...) for a right-hand holder (JSXXR...); the left-hand insert (JX***L...) for a left-hand holder (JSXXL...).

JSXXR/L-S

Parting toolholder, for Swiss lathes (for sub spindle)

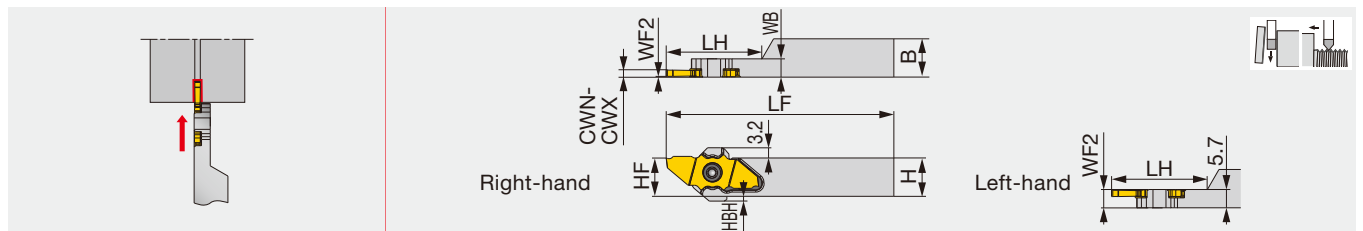

Designation	CWN	CWX	H	B	LF**	LH**	HF	WF2	HBH	Insert	Torque*
JSXXR/L1010X09-S	0.6	2.5	10	10	120	26	10	0.2/5.5	3	JX**06...,12...,16...	1.2
JSXXR/L1212F09-S	0.6	2.5	12	12	85	26	12	0.2/5.5	1.5	JX**06...,12...,16...	1.2
JSXXR/L1212X09-S	0.6	2.5	12	12	120	30	12	0.2/5.5	1.5	JX**06...,12...,16...	1.2
JSXXR/L1616X09-S	0.6	2.5	16	16	120	30	16	0.2/5.5	-	JX**06...,12...,16...,20...	1.2

Torque*: Recommended torque (N-m) for clamping

**LF (Functional Length) and LH (Head Length) values shown above are true with JXPG16... insert. LF and LH will be 2 mm shorter than the above values with JX*G12... insert, and 4 mm shorter for JXPG06... insert. LF, LH, and HBL will all be 2 mm shorter with JXPG20... insert.

***JXPG20... insert will not fit.

Note: Use the right-hand insert (JX***R...) for a right-hand holder (JSXXR...); the left-hand insert (JX***L...) for a left-hand holder (JSXXL...).

SPARE PARTS

Designation	Clamping screw	Wrench
JSXXR..., JSXXR****09-S	CSTC-4L055DL	T-1008/5
JSXXL..., JSXXL****09-S	CSTC-4L055DR	T-1008/5

Parting-off toolholders with high pressure coolant capability, for swiss lathes

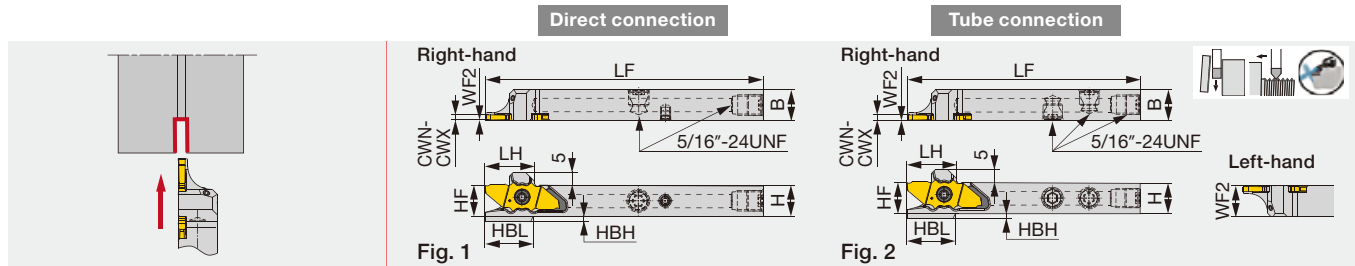

Designation	CWN	CWX	H	B	LF ⁽¹⁾	LH ⁽¹⁾	HF	WF2 ⁽²⁾	HBL ⁽¹⁾	HBH	Insert	Torque*	Fig.
JSXXR/L1012H09-CHP ⁽³⁾	0.6	2.5	10	12	102	19.2	10	0.2/11.8	18.7	3	JX**06...,12...,16..., 20...	1.2	1
JSXXR/L1212F09-CHP	0.6	2.5	12	12	85	19.4	12	0.2/11.8	18.8	2	JX**06...,12...,16..., 20...	1.2	2
JSXXR/L1212X09-CHP ⁽³⁾	0.6	2.5	12	12	120	19.4	12	0.2/11.8	18.8	2	JX**06...,12...,16..., 20...	1.2	1
JSXXR/L1616X09B-CHP ⁽³⁾	0.6	2.5	16	16	120	19.4	16	0.2/15.8	18.7	-	JX**06...,12...,16..., 20...	1.2	1

Torque*: Recommended clamping torque (N·m)
 (1) LF (Functional Length) LH (Head Length), and HBL (Head-bottom Offset Length) values shown above are true with JX**16... insert. LF, LH, and HBL will all be 2 mm shorter than the above values with JX**12... and JX**20... inserts, and 4 mm shorter for JX**06... insert.
 (2) The first value before "/" indicates the WF for the right-hand holder and the second value after "/" for the left-hand holder.
 (3) Compatible to the direct internal coolant supply system without the use of external coolant hose.
 (4) To be replaced with the new design
 Note: Use the right-hand insert (JX***R...) for a right-hand holder (JSXXR...); the left-hand insert (JX***L...) for a left-hand holder (JSXXL...).

JSXXR/L-F/X-S-CHP

Parting-off toolholders with high pressure coolant capability, for swiss lathes (for sub spindle)

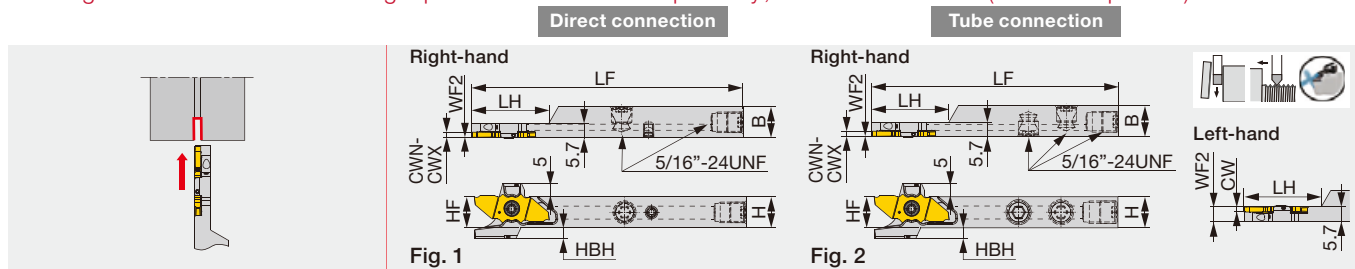

Designation	CWN	CWX	H	B	LF ⁽¹⁾	LH ⁽¹⁾	HF	W2F ⁽²⁾	HBH	Insert	Torque*	Fig.
JSXXR1212F09-S-CHP ⁽⁴⁾	0.6	2.5	12	12	85	26	12	0.2	4	JX**06...,12...,16..., 20...	1.2	2
JSXXR/L1212F09B-S-CHP	0.6	2.5	12	12	85	30	12	0.2/5.5	2	JX**06...,12...,16..., 20...	1.2	2
JSXXR/L1212X09-S-CHP ^{(3),(4)}	0.6	2.5	12	12	120	30	12	0.2/5.5	4	JX**06...,12...,16..., 20...	1.2	1
JSXXR/L1212X09B-S-CHP ⁽³⁾	0.6	2.5	12	12	120	30	12	0.2/5.5	2	JX**06...,12...,16..., 20...	1.2	1
JSXXR1616X09-S-CHP ^{(3),(4)}	0.6	2.5	16	16	120	30	16	0.2	1.5	JX**06...,12...,16..., 20...	1.2	1
JSXXR/L1616X09B-S-CHP ⁽³⁾	0.6	2.5	16	16	120	30	16	0.2/5.5	-	JX**06...,12...,16..., 20...	1.2	1

Torque*: Recommended clamping torque (N·m)
 (1) LF (Functional Length) and LH (Head Length) values shown above are true with JX**16... insert. Both LF and LH will be 2 mm shorter than the above value with JX**12... and JX**20... inserts; 4 mm shorter with JX**06... insert.
 (2) The first value before "/" indicates the WF for the right-hand holder and the second value after "/" for the left-hand holder.
 (3) Compatible to the direct internal coolant supply system without the use of external coolant hose.
 (4) To be replaced with the new design
 Note: Use the right-hand insert (JX***R...) for a right-hand holder (JSXXR...); the left-hand insert (JX***L...) for a left-hand holder (JSXXL...).

SPARE PARTS						
Designation	Clamping screw	Wrench 1	Coolant plug	Wrench 2	DirectJet plug	Wrench 3
JSXXR**F...	CSTC-4L100DL	T-1008/5	SR5/16UNFTL360	P-4	-	-
JSXXL**F...	CSTC-4L100DR	T-1008/5	SR5/16UNFTL360	P-4	-	-
JSXXR**H/X...	CSTC-4L100DL	T-1008/5	SR5/16UNFTL360	P-4	SSH4-6-TB	P-2
JSXXL**H/X...	CSTC-4L100DR	T-1008/5	SR5/16UNFTL360	P-4	SSH4-6-TB	P-2

Reference pages: JSXXR/L-F/H/X-CHP, JSXXR/L-F/X-S-CHP:
 Inserts → **G173 - G175**, Standard cutting conditions → **G176**

HOW TO SELECT TOOLS

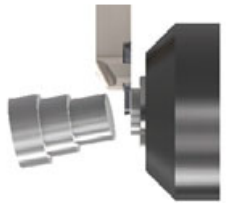
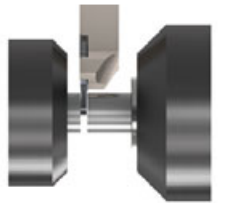
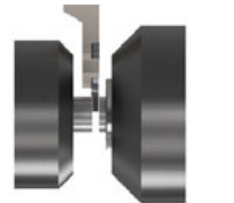
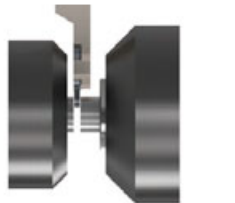
Application	Large-diameter machining of workpiece with rigidity		Small-diameter machining of workpiece with short overhang	
	Main-spindle tooling	Sub-spindle tooling	Sub-spindle tooling	
			Workpiece with long overhang at the side of sub-spindle for the process after parting-off	Short workpiece with low rigidity
				
Position of parting-off is at the side of the main spindle	Position of parting-off is at the side of the sub-spindle	Position of parting-off is at the side of the main spindle	Position of parting-off is at the side of the sub-spindle	
Toolholder	R-hand (JSXXR type)	L-hand (JSXXL type)	R-hand (JSXXR-S type)	L-hand (JSXXL-S type)
Insert	Right-hand insert with lead angle to remove center core (JXPG**R***-15 type)	Left-hand insert (JXPG**L*** type)	Right-hand insert (JXPG**R*** type)	Left-hand insert (JXPG**L*** type)

HOW TO SELECT TOOLHOLDERS FOR SUB-SPINDLE

Sub-spindle dia.	Parting-off dia.	B	LF	Insert	Toolholder
ø40	~ ø6	10	116	JXPG06*	JSXXR/L1010X09-S
ø40	~ ø6	12	81	JXPG06*	JSXXR/L1212F09-S
ø40	~ ø12	10	118	JXPG12*	JSXXR/L1010X09-S
ø40	~ ø12	12	83	JXPG12*	JSXXR/L1212F09-S
ø40	~ ø16	10	120	JXPG16*	JSXXR/L1010X09-S
ø40	~ ø16	12	85	JXPG16*	JSXXR/L1212F09-S
ø40	~ ø20	12	87	JXPG20*	JSXXR/L1212F09B-S-CHP
ø50	~ ø6	12	116	JXPG06*	JSXXR/L1212X09-S
ø50	~ ø6	16	116	JXPG06*	JSXXR/L1616X09-S
ø50	~ ø12	12	118	JXPG12*	JSXXR/L1212X09-S
ø50	~ ø12	16	118	JXPG12*	JSXXR/L1616X09-S
ø50	~ ø16	12	85	JXPG16*	JSXXR/L1212F09-S
ø50	~ ø16	12	120	JXPG16*	JSXXR/L1212X09-S
ø50	~ ø16	16	120	JXPG16*	JSXXR/L1616X09-S
ø50	~ ø20	12	87	JXPG20*	JSXXR/L1212F09B-S-CHP
ø50	~ ø20	12	122	JXPG20*	JSXXR/L1212X09B-S-CHP
ø50	~ ø20	16	122	JXPG20*	JSXXR/L1616X09-S

MAX. PARTING-OFF DIA. & DEPTH

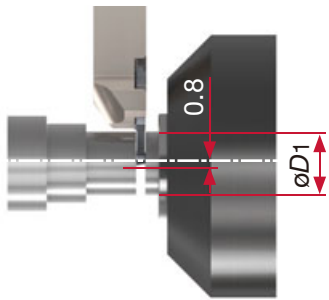
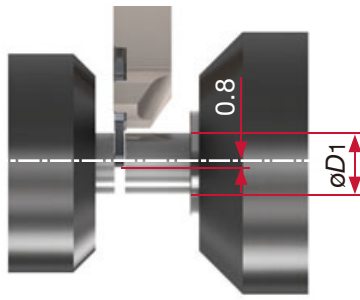
Main-spindle tooling	Sub-spindle tooling
	

There will be no tool-workpiece interference when parting off the workpiece with the cutting edge position apart from the workpiece center by 0.8 mm or more.

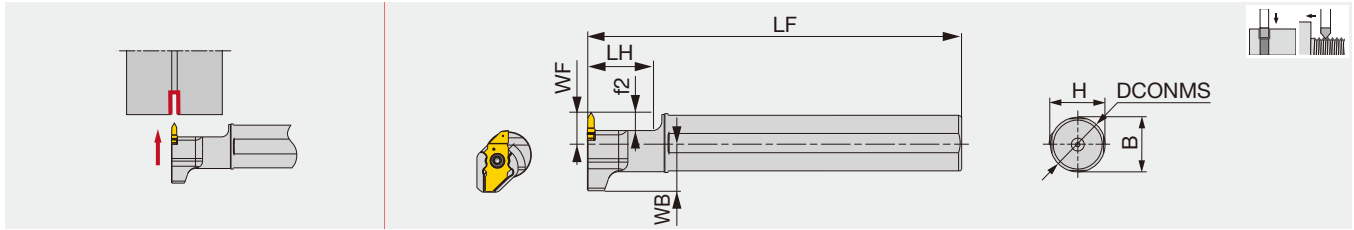

Designation	CWN	CWX	DCONMS	H	B	LF	LH	WB	WF	f2	Insert	Torque*
JS19G-SXXL09	0.6	2.5	19.05	18	18	90	21	15.43	10	6	JX**06,12*R	1.2
JS19X-SXXL09	0.6	2.5	19.05	18	18	120	21	15.43	10	6	JX**06,12*R	1.2
JS20G-SXXL09	0.6	2.5	20	19	19	90	21	15.4	10	6	JX**06,12*R	1.2
JS20X-SXXL09	0.6	2.5	20	19	19	120	21	15.4	10	6	JX**06,12*R	1.2
JS22X-SXXL09	0.6	2.5	22	21	21	120	21	15.4	10	6	JX**06,12*R	1.2
JS25H-SXXL09	0.6	2.5	25	24	24	100	21	15.4	10	6	JX**06,12*R	1.2
JS254X-SXXL09	0.6	2.5	25.4	24	24	120	21	15.4	10	6	JX**06,12*R	1.2

* Torque: Recommended torque (N-m) for clamping
Threading insert (JXTG12FR) and parting-off inserts (JXPG06R , 12R) fit this holder.

SPARE PARTS

Designation	Clamping screw	Wrench
JS***-SXXL09	CSTC-4L100DL	T-1008/5



INSERT

JXPS**R/L-F (with 3D chipbreaker, sharp edge)

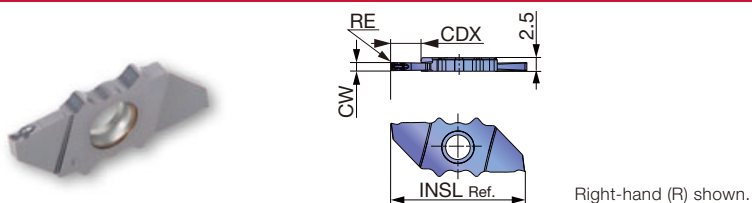

Right-hand (R) shown.

P	Steel	★					
M	Stainless	★					
K	Cast iron	★					
N	Non-ferrous						
S	Superalloys	★					
H	Hard materials						

★ : First choice

Designation	HAND	CW±0.025	RE	Coated				CUTDIA	CDX*	INSL
				SH725						
JXPS06R06F	R	0.6	0.05	●				6	3.5	21
JXPS06L06F	L	0.6	0.05	●				6	3.5	21
JXPS12R08F	R	0.8	0.05	●				12	6.5	25
JXPS12L08F	L	0.8	0.05	●				12	6.5	25
JXPS12R10F	R	1	0.05	●				12	6.5	25
JXPS12L10F	L	1	0.05	●				12	6.5	25
JXPS12R15F	R	1.5	0.05	●				12	6.5	25
JXPS12L15F	L	1.5	0.05	●				12	6.5	25
JXPS16R15F	R	1.5	0.05	●				16	8.5	29
JXPS16L15F	L	1.5	0.05	●				16	8.5	29
JXPS20R20F	R	2	0.05	●				20	10.5	33
JXPS20L20F	L	2	0.05	●				20	10.5	33

*Max grooving depth (CDX) varies depending on workpiece diameters.

● : Line up

JXDX**R-F (PCD insert)

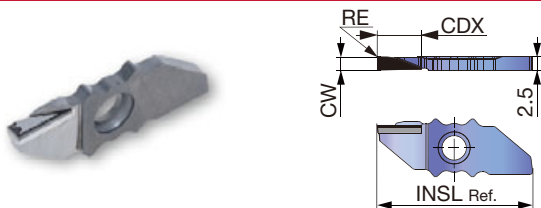

P	Steel						
M	Stainless						
K	Cast iron						
N	Non-ferrous	★					
S	Superalloys						
H	Hard materials						

★ : First choice

Designation	HAND	CW±0.05	RE	PCD				CDX	INSL
				DX110					
JXDX12R20F	R	2	< 0.1	●				6	25
JXDX12R25F	R	2.5	< 0.1	●				6.5	25
JXDX16R25F	R	2.5	< 0.1	●				7	29

● : Line up

JXPG**R/L-F (sharp edge)

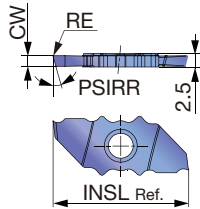

Right hand (R) shown.

P	Steel	★						
M	Stainless	★						
K	Cast iron	★						
N	Non-ferrous	★						
S	Superalloys	★						
H	Hard materials	★						

★ : First choice
☆ : Second choice



Designation	HAND	CW±0.025	RE	Coated					CUTDIA	INSL	PSIRR/L
				SH725							
JXPG06R10F	R	1	0.05	●					6	21	0°
JXPG06L10F	L	1	0.05	●					6	21	0°
JXPG06R15F	R	1.5	0.05	●					6	21	0°
JXPG06L15F	L	1.5	0.05	●					6	21	0°
JXPG06R10F-15	R	1	0.05	●					6	21	15°
JXPG06L10F-15	L	1	0.05	●					6	21	15°
JXPG06R15F-15	R	1.5	0.05	●					6	21	15°
JXPG06L15F-15	L	1.5	0.05	●					6	21	15°
JXPG12R15F	R	1.5	0.05	●					12	25	0°
JXPG12L15F	L	1.5	0.05	●					12	25	0°
JXPG12R20F	R	2	0.05	●					12	25	0°
JXPG12L20F	L	2	0.05	●					12	25	0°
JXPG12R15F-15	R	1.5	0.05	●					12	25	15°
JXPG12L15F-15	L	1.5	0.05	●					12	25	15°
JXPG12R20F-15	R	2	0.05	●					12	25	15°
JXPG12L20F-15	L	2	0.05	●					12	25	15°
JXPG16R15F	R	1.5	0.05	●					16	29	0°
JXPG16L15F	L	1.5	0.05	●					16	29	0°
JXPG16R20F	R	2	0.05	●					16	29	0°
JXPG16L20F	L	2	0.05	●					16	29	0°
JXPG16R15F-15	R	1.5	0.05	●					16	29	15°
JXPG16L15F-15	L	1.5	0.05	●					16	29	15°
JXPG16R20F-15	R	2	0.05	●					16	29	15°
JXPG16L20F-15	L	2	0.05	●					16	29	15°
JXPG20R15F	R	1.5	0.05	●					20	33	0°
JXPG20L15F	L	1.5	0.05	●					20	33	0°
JXPG20R20F	R	2	0.05	●					20	33	0°
JXPG20L20F	L	2	0.05	●					20	33	0°
JXPG20R15F-15	R	1.5	0.05	●					20	33	15°
JXPG20L15F-15	L	1.5	0.05	●					20	33	15°
JXPG20R20F-15	R	2	0.05	●					20	33	15°
JXPG20L20F-15	L	2	0.05	●					20	33	15°

● : Line-up
CUTDIA: Max. parting-off dia.
Packing quantity = 5 pcs.

Reference pages: Toolholders → [G086 - G088](#), [G090](#), Standard cutting conditions → [G176](#)

JXTG12FR/L-60 (For Threading / Sharp edge)

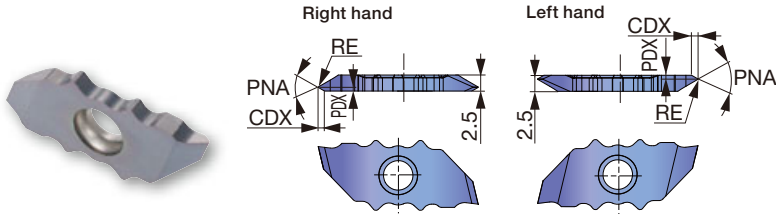

P	Steel	★						
M	Stainless	★						
K	Cast iron	★						
N	Non-ferrous	★						
S	Superalloys	★						
H	Hard materials	★						

★ : First choice
☆ : Second choice

Designation	HAND	RE	Coated														
			SH725						Pitches	PDX	CDX	PNA					
JXTG12FR-60A-000	R	Flat (0.05 max)	●										0.2 - 0.4	0.25	0.4	60°	
JXTG12FL-60A-000	L	Flat (0.05 max)	●											0.2 - 0.4	0.25	0.4	60°
JXTG12FR-60B-000	R	Flat (0.05 max)	●											0.2 - 0.4	2.25	0.4	60°
JXTG12FL-60B-000	L	Flat (0.05 max)	●											0.2 - 0.4	2.25	0.4	60°
JXTG12FR-60A-005	R	0.05	●											0.4 - 1	0.6	0.99	60°
JXTG12FL-60A-005	L	0.05	●											0.4 - 1	0.6	0.99	60°
JXTG12FR-60B-005	R	0.05	●											0.4 - 1	1.9	0.99	60°
JXTG12FL-60B-005	L	0.05	●											0.4 - 1	1.9	0.99	60°
JXTG12FR-60N-010	R	0.1	●											1 - 1.5	1.25	2.07	60°
JXTG12FL-60N-010	L	0.1	●											1 - 1.5	1.25	2.07	60°

● : Line-up
Packing quantity = 5 pcs.

Grade
Insert
Ext. Toolholder
Int. Toolholder
Threading
Grooving
Miniature tool
Milling cutter
Endmill
Drilling tool
Tooling System
User's Guide
Index

A
B
C
D
E
F
G
H
I
J
K
L
M

Parting, Grooving

ISO	Workpiece materials	Grades	Cutting speed Vc (m/min)	Feed f (mm/rev)
P	Low carbon steels S15C, SS400, etc. C15E4, E275A, etc.	SH725	50 - 200	0.01 - 0.05
	Carbon steels, Alloy steels S55C, SCM440, etc. C55, 42CrMo4, etc.	SH725	50 - 200	0.01 - 0.05
	Free cutting steels SUH22, SUH23, etc.	SH725	50 - 200	0.01 - 0.05
M	Stainless steels SUS304, X5CrNi18-9, etc.	SH725	50 - 200	0.01 - 0.05
N	Aluminium alloys A5056, A6061, etc.	SH725	150 - 200	0.01 - 0.05
	Copper alloy C2600, C280C, etc.	SH725	100 - 200	0.01 - 0.05
S	Titanium alloys Ti-6Al-4V, etc.	SH725	30 - 80	0.01 - 0.05
	Superalloys Inconel718, etc.	SH725	30 - 80	0.01 - 0.05



For aluminium and non-ferrous metal PCD insert

ISO	Workpiece materials	Grades	Operation	Cutting speed Vc (m/min)	Feed f (mm/rev)	Depth of cut ap (mm)
N	Aluminium alloys A5056, A6061, etc.	DX110	Grooving	100 - 300	0.03 - 0.15	-
		DX110	Turning	100 - 300	0.03 - 0.15	< 6

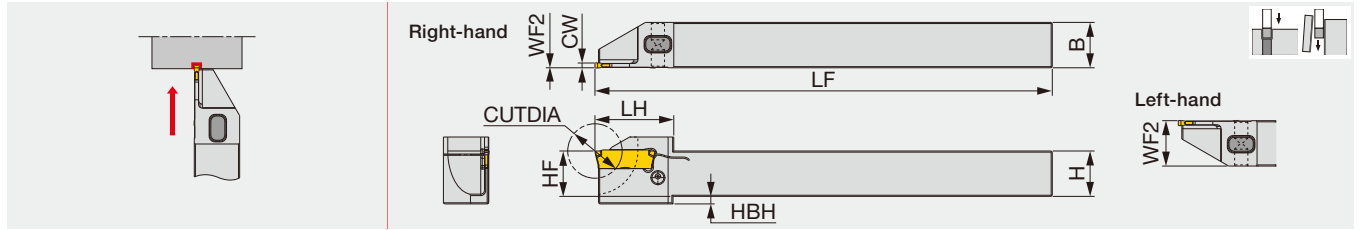

Designation	CW	Seat size	CUTDIA	H	B	LF	LH	HF	WF2 ⁽¹⁾	HBH	Torque*
JTTER/L1010H1.2D12	1.2	0.9	12	10	10	100	17	10	0/10	-	1.5
JTTER/L1212F1.2D16	1.2	0.9	16	12	12	85	19	12	0/12	-	1.5
JTTER/L1212X1.2D16	1.2	0.9	16	12	12	120	19	12	0/12	-	1.5
JTTER/L1212X1.2D20	1.2	0.9	20	12	12	120	21	12	0/12	2	1.5
JTTER/L1616X1.2D20	1.2	0.9	20	16	16	120	21	16	0/16	-	2

(1) "WF" value is calculated with groove width "CW" shown in the table. The first value before "/" indicates the WF for the right-hand holder and the second value after "/" for the left-hand holder.

Torque*: Recommended clamping torque (N-m)

JTTER/L-S

External grooving and parting toolholder, for Swiss lathes (for sub spindle)

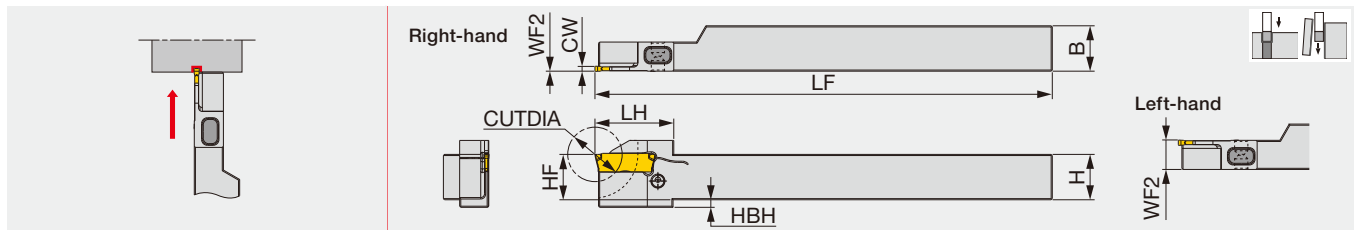

Designation	CW	Seat size	CUTDIA	H	B	LF	LH	HF	WF2 ⁽¹⁾	HBH	Torque*
JTTER/L1010H1.2D12-S	1.2	0.9	12	10	10	100	17	10	0/7.7	-	1.5
JTTER1212F1.2D16-S ⁽²⁾	1.2	0.9	16	12	12	85	19	12	0	-	1.5
JTTER/L1212X1.2D16-S	1.2	0.9	16	12	12	120	21	12	0/7.7	-	1.5
JTTER/L1212X1.2D20-S	1.2	0.9	20	12	12	120	21	12	0/7.7	2	1.5
JTTER/L1616X1.2D20-S	1.2	0.9	20	16	16	120	21	16	0/7.7	-	1.5

(1) "WF" value is calculated with groove width "CW" shown in the table. The first value before "/" indicates the WF for the right-hand holder and the second value after "/" for the left-hand holder.

(2) No clamping screw from the insert side.

Torque*: Recommended clamping torque (N-m)

SPARE PARTS

Designation	Clamping screw	Clamping pin	Wrench
JTTER/L1010, 1212..., JTTER/L*-S	SSM3.5x0.35	PIN-SL-TC	P-2F
JTTER/L1616...	SRM5-24145-RL	PIN-32121	P-2.5F

Modular head for external grooving and parting, with high pressure coolant capability

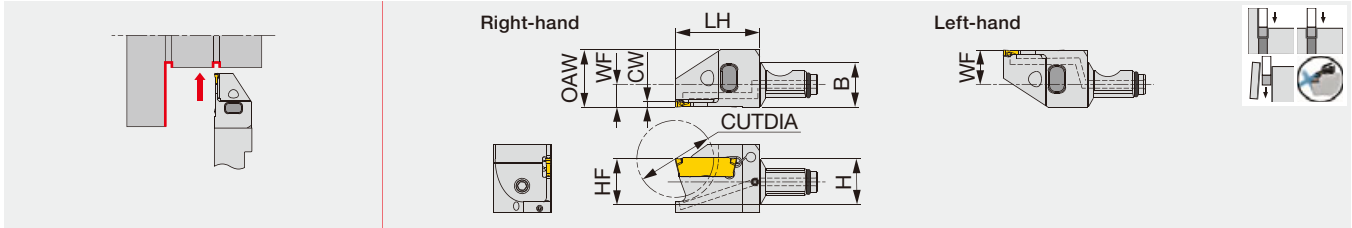

Designation	CW	Seat size	CUTDIA	H	B	LH	HF	WF ⁽¹⁾	OAW	Torque*
QC12-JTTER/L1.2D20-CHP	1.2	0.9	20	12	12	22	12	6/9	15	1.5
QC12-JTTER/L1.4D20-CHP	1.4	1	20	12	12	22	12	6/9	15	1.5
QC12-JTTER/L2D20-CHP	2	2	20	12	12	22	12	6/9	15	1.5

(1) "WF" value is calculated with groove width "CW" shown in the table. The first value before "/" indicates the WF for the right-hand holder and the second value after "/" for the left-hand holder.

Torque*: Recommended clamping torque (N·m)

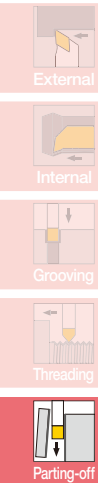

JCTER/L

External grooving and parting toolholder, for Swiss lathes

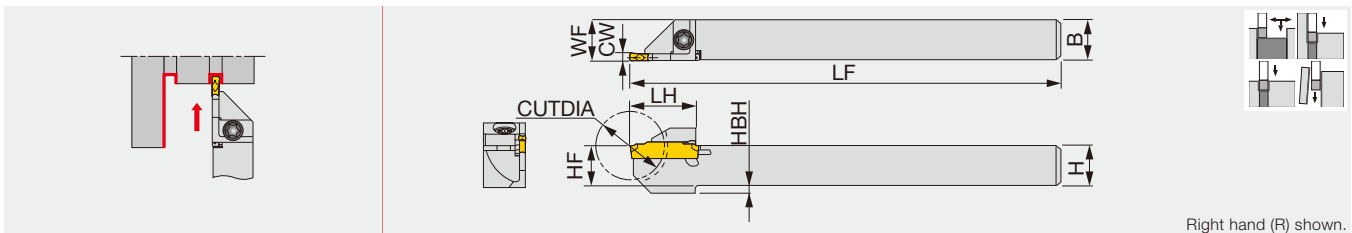

Right hand (R) shown.

Designation	CW	Seat size	CUTDIA	H	B	LF	LH	HF	WF ⁽¹⁾	HBH	Torque*
JCTER/L1010X1.4T10	1.4	1	20	10	10	120	18	10	10.2	-	3
JCTER/L1212F1.4T12	1.4	1	24	12	12	85	19.5	12	12.2	-	3
JCTER/L1212X1.4T12	1.4	1	24	12	12	120	19.5	12	12.2	-	3
JCTER/L1414-1.4T12	1.4	1	24	14	14	125	19.5	14	14.2	-	3
JCTER/L1616X1.4T16	1.4	1	32	16	16	120	24	16	16.2	-	3
JCTER/L1010X2T10	2	2	20	10	10	120	19	10	10.1	2	3
JCTER/L1212F2T12	2	2	24	12	12	85	19	12	12.1	2	3
JCTER/L1212X2T12	2	2	24	12	12	120	19	12	12.1	2	3
JCTER/L1414-2T12	2	2	24	14	14	125	19	14	14.1	-	3
JCTER/L1616X2T16	2	2	32	16	16	120	24	16	16.1	-	3
JCTER/L1212F3T12	3	3	24	12	12	85	19	12	12.3	2	3
JCTER/L1212X3T12	3	3	24	12	12	120	19	12	12.3	2	3
JCTER/L1616X3T16	3	3	32	16	16	120	24	16	16.3	-	3
JCTER/L2020H3T16	3	3	32	20	20	100	24	20	20.3	-	3

(1) The value for "WF" is true when the insert with the width, indicated in "CW" in the table is mounted. • CUTDIA: Maximum parting-off diameter
Torque*: Recommended torque (N·m) for clamping

SPARE PARTS

Designation	Clamping screw	Clamping screw 1	Clamping pin	Wrench	Wrench 1	O-ring
QC12-JTTER/L...	-	SSM3.5x0.35	PIN-SL-TC	-	P-2F	ORSS-0454.5X1.0NBR70
JCTER/L...	CSHB-4-A	-	-	T-15F	-	-

Reference pages: QC12-JTTER/L-CHP, JCTER/L: Inserts → **G182 - G189**
Shank, Accessory → **G095 - G096**, Standard cutting conditions → **G190**

JCTER/L2012

External grooving and parting toolholder, for Swiss lathes

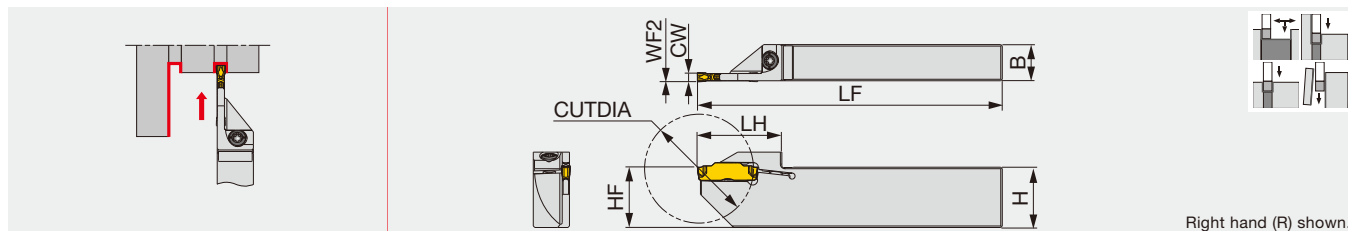

Designation	CW	Seat size	CUTDIA	H	B	LF	LH	HF	WF2 ⁽¹⁾	Torque*
JCTER/L2012H2T18	2	2	36	20	12	100	25	20	0.1	3
JCTER/L2012H3T21	3	3	42	20	12	100	28	20	0.3	3

(1) "WF" value is calculated with groove width "CW" shown in the table. • CUTDIA: Max. parting diameter
Torque*: Recommended clamping torque (N·m)

CGER/L

External deep grooving and parting toolholder, for Swiss lathes

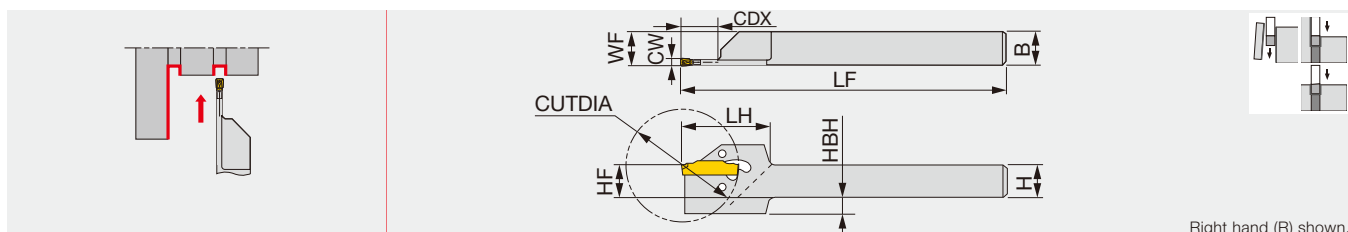

Designation	CW	Seat size	CUTDIA ⁽¹⁾	CDX	H	B	LF	LH	HF	WF ⁽²⁾	HBH
CGER/L2020-1.4T14	1.4	1	29/29	9.7	20	20	125	31	20	20.2	-
CGER/L1212-2T17	2	2	35/35	11.8	12	12	150	31	12	12.1	6
CGER/L1616-2T17	2	2	35/35	11.8	16	16	150	31	16	16.1	2
CGER/L2020-2T17	2	2	35/35	9.8	20	20	125	31	20	20.1	-
CGER/L1212-3T19	3	3	38/40	12	12	12	150	31	12	12.3	6
CGER/L1616-3T19	3	3	38/45	14.9	16	16	150	31	16	16.3	2
CGER/L2020-3T19	3	3	38/45	13.2	20	20	125	31	20	20.3	-
CGER/L2020-4T19	4	4	38/55	20.3	20	20	125	33	20	20.4	-

(1) DG*/SG* Maximum diameter of parting off Dmax, can be increased by using SG* insert for some toolholders. (2) "WF" value is calculated with groove width "CW" shown in the table. Wrench, CRW**, should be ordered separately. Insert is clamped by the elastic deformation of upper jaw.

SPARE PARTS

Designation	Clamping screw	Wrench	Wrench (Option)
JCTER/L2012...	CSHB-4-A	T-15F	-
CGER/L2020-1.4T14	-	-	CRW23
CGER/L****-2T17 - 4T19	-	-	CRW33

External grooving and parting-off toolholder, high pressure coolant compatible

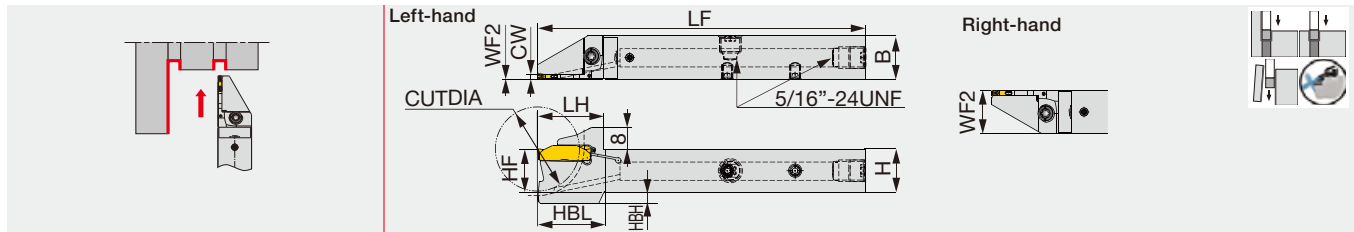

Designation	CW	Seat size	CUTDIA	H	B	LF	LH	HBL	HF	WF2 ⁽¹⁾	HBH	Torque*
JCTER/L1212X2T12-CHP	2	2	25	12	12	120	24.7	24.7	12	0/12	5	3.0
JCTER/L1616X2T12-CHP	2	2	25	16	16	120	24.7	24.5	16	0/16	1	3.0
JCTER/L1616X2T16-CHP	2	2	32	16	16	120	24.7	24.7	16	0/16	4	3.0
JCTER/L2020X2T16-CHP	2	2	32	20	20	120	24.7	-	20	0/20	0	3.0

(1) "WF" value is calculated with groove width "CW" shown in the table. • CUTDIA: Max. parting off dia.
Torque*: Recommended torque (N-m) for clamping

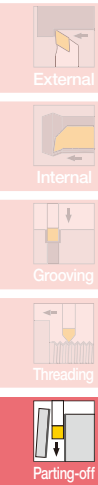

CHGP

Parting-off and external grooving blade

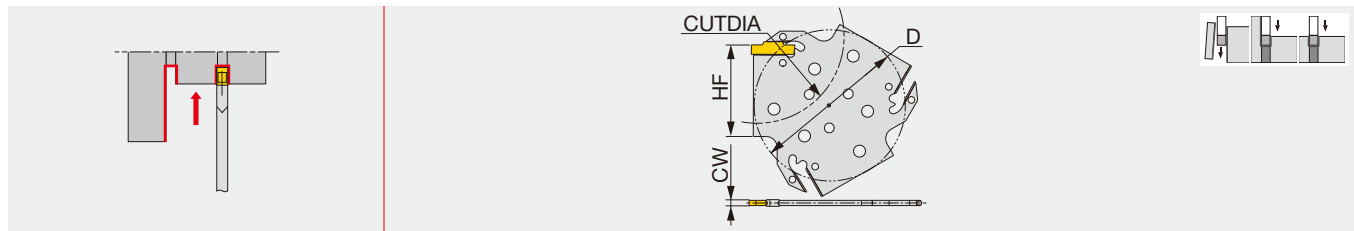

Designation	CW	Seat size	CUTDIA	HF	D
CHGP52-2T	2	2	52	27	48.3
CHGP52-3T	3	3	52	27	48.3
CHGP82-3T	3	3	82	42	69.3
CHGP82-4T	4	4	82	42	69.3

.When depth is deeper than insert length - 1.5mm, 1 corner type is recommended

SPARE PARTS

Designation	Clamping screw	Wrench	Coolant plug	Wrench	DirectJet plug	Wrench	Wrench (Option)
JCTER/L...	CSHB-4-A	T-15F	SR5/16UNFTL360	P-4	SSHM4-6-TB	P-2	-
CHGP...	-	-	-	-	-	-	CRW33

Reference pages: JCTER/L-CHP, CHGP: Inserts → [G182 - G189](#), Toolblock → [G192](#)
Standard cutting conditions → [G190](#)

CGP

External deep grooving and parting blade

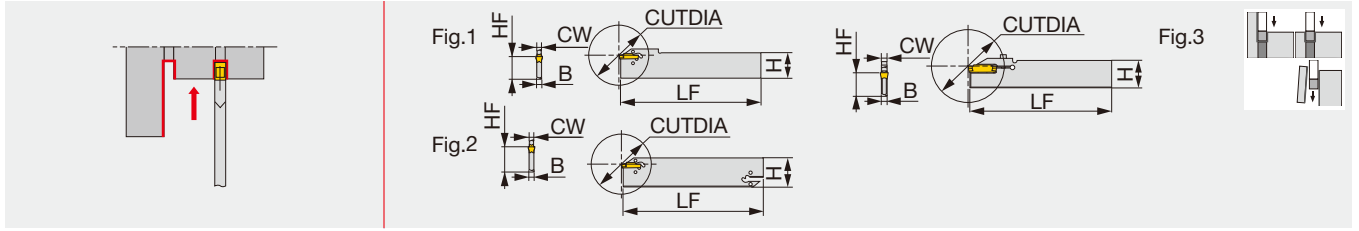

Designation	CW	Seat size	CUTDIA	H	B	LF	HF	Fig.	Torque*
CGP26-1.4S	1.4	1	26	26	1	150	21.4	1	-
CGP32-1.4D	1.4	1	26	32	1	150	24.8	2	-
CGP26-2S	2	2	40	26	1.8	150	21.4	1	-
CGP32-2D	2	2	50	32	1.8	150	24.8	2	-
CGP26-3S	3	3	50	26	2.4	150	21.4	1	-
CGP32-3D	3	3	100	32	2.4	150	24.8	2	-
CGP26-4S	4	4	80	26	3.2	150	21.4	1	-
CGP32-4D	4	4	100	32	3.2	150	24.9	2	-
CGP45-4D	4	4	120	45	3.2	150	38.1	2	-
CGP32-5D	5	5	120	32	4	150	24.9	2	-
CGP32-6D	6	6	120	32	5.2	150	24.9	2	-
CGP32-8S-CL	8	8	80	32	6.2	150	24.9	3	3

When depth is deeper than (insert length - 1.5mm), 1 corner type is recommended.
Wrench (CRW...) is not included. Please order it separately.
*Torque: Recommended clamping torque (N·m)

Caution

Newly developed clamp

.Insert is clamped by the elastic deformation of upper jaw
.Low clamping stress increases the stability and tool life

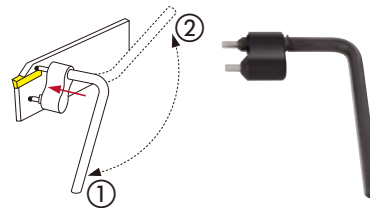

unclamp : ① → ②
clamp : ② → ①

CTBU

Tool blocks for CGP blade

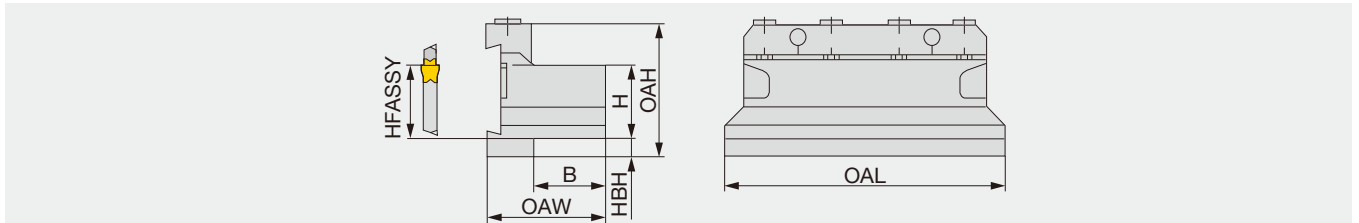

Designation	H	B	OAL	HFASSY	HBH	OAH	OAW	Blade (Optional)
CTBU20-26	20	21	86	20	9	43	38	CGP26...
CTBU25-26	25	23	110	25	5	45	43	CGP26...
CTBU20-32	20	19	100	20	13	50	38	CGP32...
CTBU25-32	25	23	110	25	8	50	42	CGP32...
CTBU32-32	32	29	110	32	5	54	48	CGP32...

SPARE PARTS

Designation	Clamp	Clamping screw	Wrench	Wrench (Optional)
CGP**-1.4*	-	-	-	CRW23
CGP**-2/3/4/5/6	-	-	-	CRW33
CGP32-8S-CL	-	CM4X0.7X20-M0-A	P-3	-
CTBU20-26	CT-86	CM6X30-S	P-5	-
CTBU25-26	CT-105	CM6X30-S	P-5	-
CTBU20-32	CT-100	CM6X30-S	P-5	-
CTBU25-32, CTBU32-32	CT-110	CM6X30-S	P-5	-

Reference pages: CGP: Inserts → **G182 - G189**, Standard cutting conditions → **G190**

CTBU-CHP

Tool block for CGP-CHP blade with high pressure internal coolant capacity

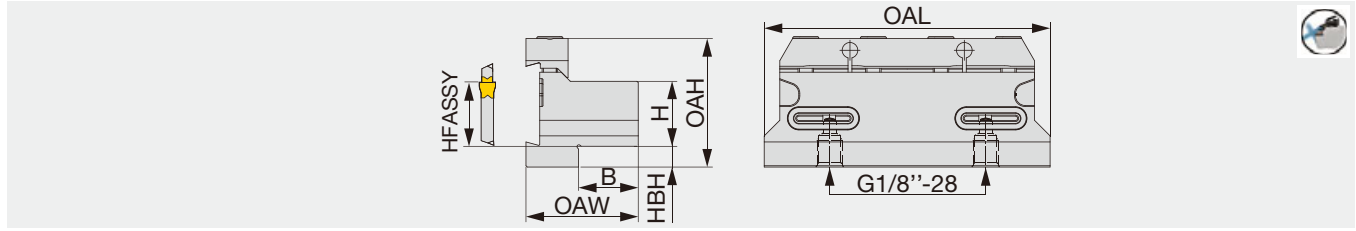

Designation	H	B	OAL	HFASSY	HBH	OAH	OAW	Blade (Optional)
CTBU25-32-CHP	25	23	110	25	8	50	43.2	CGP32-'D-CHP

Applicable for 14 MPa coolant





SPARE PARTS

Designation	Clamping screw	Clamp	Wrench	O-ring
CTBU25-32-CHP	12.9-SRM6X16DIN912	110-CT	5-P	OR14X2.5NN

TUNG CUT

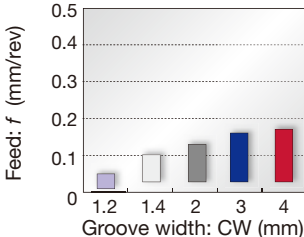
CHIPBREAKER GUIDE

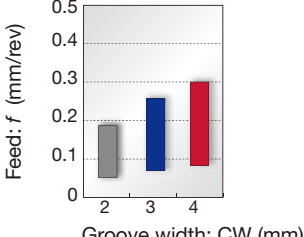

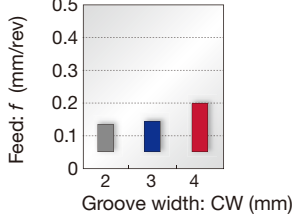
External grooving and parting



<p>DGS type (2 corners) SGS type (1 corner)</p>  <p>G184, G187</p>	<p>For Swiss lathes</p> <p>Unique-designed edge and chipbreaker</p> <p>Handed insert available</p> <p>CW = 1.2 - 4 mm</p>	<p>Standard feed</p>  <p>Feed: f (mm/rev)</p> <p>Groove width: CW (mm)</p>
<p>DGM type (2 corners) SGM type (1 corner)</p>  <p>G185, G186</p>	<p>High fracture resistance</p> <p>Smooth chip evacuation</p> <p>Well-designed edge with high strength</p> <p>Handed insert available</p> <p>CW = 2 - 4 mm</p>	<p>Standard feed</p>  <p>Feed: f (mm/rev)</p> <p>Groove width: CW (mm)</p>
<p>DGL type (2 corners)</p>  <p>G189</p>	<p>1st choice for mild steel</p> <p>Chipbreaker with excellent chip control at low feed</p> <p>Suitable for mild steel that often has difficulties in chip control</p> <p>CW = 2 - 4 mm</p>	<p>Standard feed</p>  <p>Feed: f (mm/rev)</p> <p>Groove width: CW (mm)</p>

Please see page G*** for the product details.

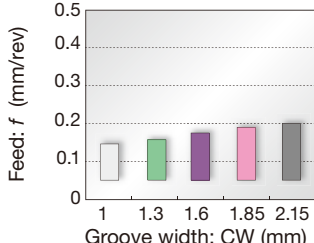

Reference pages: CTBU-CHP: Blade → F231

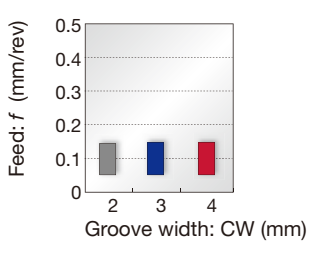
External grooving

<p>DGE type (2 corners)</p>  <p>G188</p>	<p>For shallow grooves with high accuracy</p> <p>Excellent chip control</p> <p>CW = 1 - 2.15 mm</p>	<p>■ Standard feed</p>  <p>Feed: f (mm/rev)</p> <p>Groove width: CW (mm)</p> 
--	--	---

<p>DGG type (2 corners)</p>  <p>G188</p>	<p>For non-ferrous materials and titanium alloys</p> <p>Chipbreaker with low cutting force</p> <p>Sharp cutting edge that prevents vibration and delivers fine surface finish</p> <p>CW = 2 - 4 mm</p>	<p>■ Standard feed</p>  <p>Feed: f (mm/rev)</p> <p>Groove width: CW (mm)</p> 
--	---	---

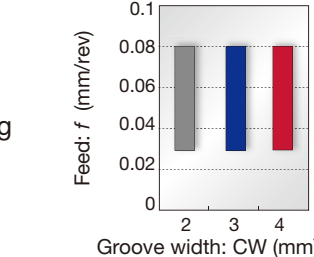
External grooving of hardened steels

<p>SGN-CBN type (1 corner)</p>  <p>G189</p>	<p>For hardened steel cutting</p> <p>Optimum cutting edge shape for grooving of hardened steels</p> <p>Close tolerance width for finishing ($W = \pm 0.025$ mm)</p> <p>CW = 2 - 4 mm</p>	<p>■ Standard feed</p>  <p>Feed: f (mm/rev)</p> <p>Groove width: CW (mm)</p> 
---	--	---

Please see page G*** for the product details.

INSERT

DGS

External grooving and parting

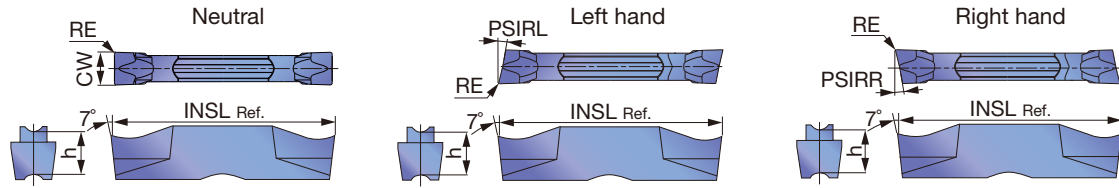

P	Steel	★	★	☆	★	☆	★	★						
M	Stainless		★	☆	★	★	★							
K	Cast iron		★		★	☆	★		☆			☆		
N	Non-ferrous											☆		
S	Superalloys		★	☆	★							★		
H	Hard materials													

★ : First choice
☆ : Second choice

Designation	Seat size	HAND	CW±0.05	RE	Coated						Cermet	Uncoated		INSL	h	PSIRL	PSIRR
					T9225	AH7025	AH725	AH8005	GH130	AH6235	NS9530	KS05F					
DGS1.2-003	0.9	N	1.2	0.03										16	4.7	0°	0°
DGS1.4-005	1	N	1.4	0.05										16	4.3	0°	0°
DGS1.4-010	1	N	1.4	0.1										16	4.3	0°	0°
DGS1.4-016	1	N	1.4	0.16										16	4.3	0°	0°
DGS2-005	2	N	2	0.05										20	5	0°	0°
DGS2-010	2	N	2	0.1										20	5	0°	0°
DGS2-020	2	N	2	0.2	●	●	●	●	●	●	●	●	●	20	5	0°	0°
DGS2-020-6R	2	R	2	0.2		●	●	●	●					20	5	0°	6°
DGS2-020-6L	2	L	2	0.2		●	●	●	●					20	5	6°	0°
DGS2-002-6R	2	R	2	0.02			●	●	●					19.5	5	0°	6°
DGS2-002-6L	2	L	2	0.02			●	●	●					19.5	5	6°	0°
DGS2-020-15R	2	R	2	0.2		●	●	●	●					20	5	0°	15°
DGS2-020-15L	2	L	2	0.2		●	●	●	●					20	5	15°	0°
DGS2-002-15R	2	R	2	0.02			●	●	●					19.5	5	0°	15°
DGS2-002-15L	2	L	2	0.02			●	●	●					19.5	5	15°	0°
DGS2.39-020	2	N	2.39	0.2		●	●	●	●					20	5	0°	0°
DGS3-020	3	N	3	0.2	●	●	●	●	●	●	●	●	●	20	5	0°	0°
DGS3-020-6R	3	R	3	0.2		●	●	●	●					20	5	0°	6°
DGS3-020-6L	3	L	3	0.2		●	●	●	●					20	5	6°	0°
DGS3-002-6R	3	R	3	0.02			●	●	●					19.45	5	0°	6°
DGS3-002-6L	3	L	3	0.02			●	●	●					19.45	5	6°	0°
DGS3-020-15R	3	R	3	0.2		●	●	●	●					20	5	0°	15°
DGS3-020-15L	3	L	3	0.2		●	●	●	●					20	5	15°	0°
DGS3-002-15R	3	R	3	0.02			●	●	●					19.45	5	0°	15°
DGS3-002-15L	3	L	3	0.02			●	●	●					19.45	5	15°	0°
DGS3.18-020	3	N	3.18	0.2		●	●	●	●					20	5	0°	0°
DGS4-030	4	N	4	0.3	●	●	●	●	●	●	●	●	●	20	5	0°	0°
DGS4-030-4R	4	R	4	0.3		●	●	●	●					20	5	0°	4°
DGS4-030-4L	4	L	4	0.3		●	●	●	●					20	5	4°	0°
DGS4.76-040	5	N	4.76	0.4		●	●	●	●					25	5.5	0°	0°
DGS5-030	5	N	5	0.3	●	●	●	●	●	●	●	●	●	25	5.5	0°	0°
DGS6-030	6	N	6	0.3	●	●	●	●	●	●	●	●	●	25	5.5	0°	0°
DGS6.35-040	6	N	6.35	0.4		●	●	●	●					25	5.5	0°	0°
DGS8-040	8	N	8	0.4		●	●	●	●					30	6.7	0°	0°

● : Line up

Caution

The tool will interfere with the workpiece when grooving larger diameters than ϕD_{max} .

Designation	ϕD_{max} (mm)	Designation	ϕD_{max} (mm)
DGM2-002-15R/L	28	DGS2-002-15R/L	28
DGM3-002-15R/L	29	DGS3-002-15R/L	29
DGM4-030-15R/L	30	SGS3-020-15R/L	103
SGM3-020-15R/L	103	SGS3-002-15R/L	34

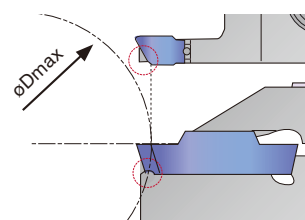

Reference pages: Toolholders → [G177 - G181](#), Standard cutting conditions → [G190](#)

DGM

External grooving and parting

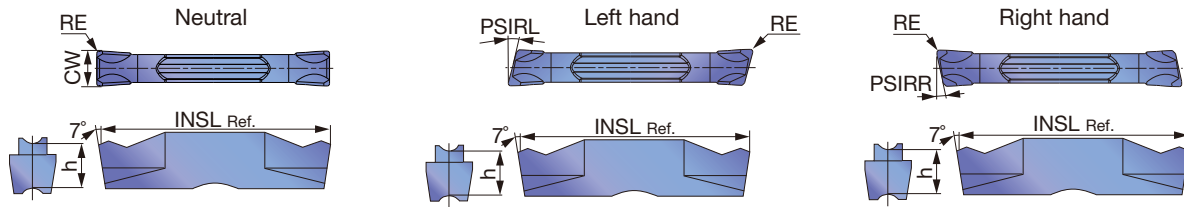

P Steel	★	★	☆	★	☆	★	★	★						
M Stainless		★	☆	★	★	★	★	★						
K Cast iron		★		★	☆	☆	★	★	☆			☆		
N Non-ferrous												☆		
S Superalloys		★	☆	★	★							★		
H Hard materials														

★ : First choice
☆ : Second choice

Designation	Seat size	HAND	CW±0.05	RE	Coated							Cermet	Uncoated	INSL	h	PSIRL	PSIRR
					T9225	AH7025	AH725	AH8005	AH905	GH130	AH6235	NS9530	KS05F				
DGM2-020	2	N	2	0.2	●	●	●	●	●	●	●	●	●	20	5	0°	0°
DGM2-020-6R	2	R	2	0.2		●	●			●				20	5	0°	6°
DGM2-020-6L	2	L	2	0.2		●	●			●				20	5	6°	0°
DGM2-020-8R	2	R	2	0.2		●	●			●				20	5	0°	8°
DGM2-020-8L	2	L	2	0.2		●	●			●				20	5	8	0°
DGM2-020-15R	2	R	2	0.2		●	●			●				20	5	0°	15°
DGM2-020-15L	2	L	2	0.2		●	●			●				20	5	15°	0°
DGM2-002-15R	2	R	2	0.02			●			●				19.35	5	0°	15°
DGM2-002-15L	2	L	2	0.02			●			●				19.35	5	15°	0°
DGM2.39-020	2	N	2.39	0.2		●		●		●				20	5	0°	0°
DGM3-020	3	N	3	0.2	●	●	●	●	●	●	●	●	●	20	5	0°	0°
DGM3-020-6R	3	R	3	0.2		●	●			●				20	5	0°	6°
DGM3-020-6L	3	L	3	0.2		●	●			●				20	5	6°	0°
DGM3-002-6R	3	R	3	0.02			●			●				19.45	5	0°	6°
DGM3-002-6L	3	L	3	0.02			●			●				19.45	5	6°	0°
DGM3-020-15R	3	R	3	0.2		●	●			●				20	5	0°	15°
DGM3-020-15L	3	L	3	0.2		●	●			●				20	5	15°	0°
DGM3.18-020	3	N	3.18	0.2		●		●		●				20	5	0°	0°
DGM4-030	4	N	4	0.3	●	●	●	●	●	●	●	●	●	20	5	0°	0°
DGM4-030-4R	4	R	4	0.3		●	●			●				20	5	0°	4°
DGM4-030-4L	4	L	4	0.3		●	●			●				20	5	4°	0°
DGM4-030-15R	4	R	4	0.3		●	●			●				20	5	0°	15°
DGM4-030-15L	4	L	4	0.3		●	●			●				20	5	15°	0°
DGM4.76-040	5	N	4.76	0.4		●		●		●				25	5.5	0°	0°
DGM5-030	5	N	5	0.3	●	●	●	●	●	●	●	●	●	25	5.5	0°	0°
DGM5-030-4R	5	R	5	0.3		●	●			●				25	5.5	0°	4°
DGM6-030	6	N	6	0.3	●	●	●	●	●	●	●	●	●	25	5.5	0°	0°
DGM6.35-040	6	N	6.35	0.4		●		●		●				25	5.5	0°	0°
DGM8-040	8	N	8	0.4	●	●	●	●		●		●		30	6.7	0°	0°

● : Line up



External deep grooving and parting

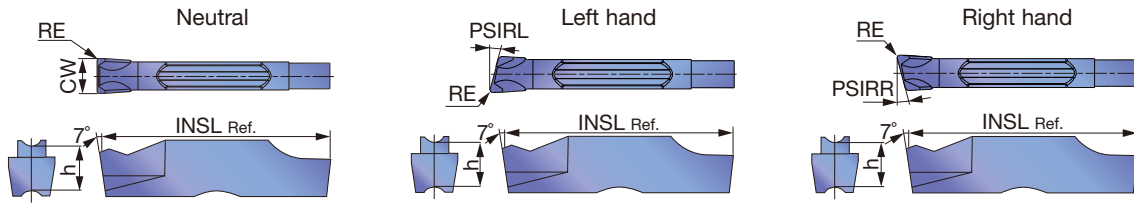

P Steel	★	☆	★	☆	★								
M Stainless	★	☆	★	★	★								
K Cast iron	★		★	☆	★		☆						
N Non-ferrous							☆						
S Superalloys	★	☆	★				★						
H Hard materials													

★ : First choice
☆ : Second choice

Designation	Seat size	HAND	CW±0.05	RE	Coated					Uncoated		INSL	h	PSIRL	PSIRR	
					AH7025	AH725	AH8005	GH130	AH6235	KS05F						
SGM2-020	2	N	2	0.2	●	●	●	●	●	●			20	5	0°	0°
SGM2-020-6R	2	R	2	0.2	●	●	●	●					20	5	0°	6°
SGM2-020-6L	2	L	2	0.2	●	●	●	●					20	5	6°	0°
SGM3-020	3	N	3	0.2	●	●	●	●	●	●			20	5	0°	0°
SGM3-020-6R	3	R	3	0.2	●	●	●	●					20	5	0°	6°
SGM3-020-6L	3	L	3	0.2	●	●	●	●					20	5	6°	0°
SGM3-020-15R	3	R	3	0.2	●	●	●	●					20	5	0°	15°
SGM3-020-15L	3	L	3	0.2	●	●	●	●					20	5	15°	0°
SGM4-030	4	N	4	0.3	●	●	●	●	●	●			20	5	0°	0°
SGM4-030-4R	4	R	4	0.3	●	●	●	●					20	5	0°	4°
SGM4-030-4L	4	L	4	0.3	●	●	●	●					20	5	4°	0°
SGM5-030	5	N	5	0.3	●	●	●	●	●	●			25	5.5	0°	0°
SGM6-030	6	N	6	0.3	●	●	●	●	●	●			25	5.5	0°	0°
SGM8-040	8	N	8	0.4	●	●	●	●	●	●			30	6.7	0°	0°

● : Line up

Reference pages: Toolholders → **G177 - G181**, Standard cutting conditions → **G190**

SGS

External deep grooving and parting

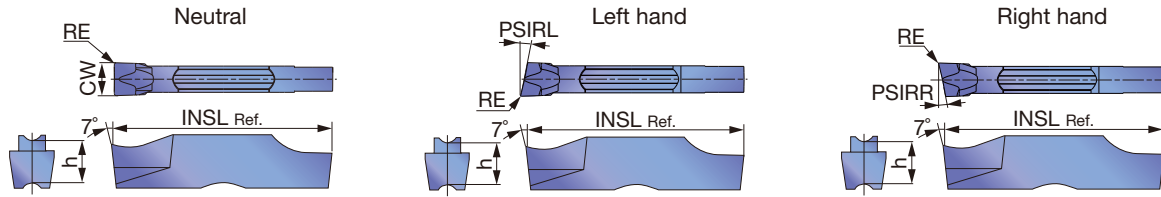

P Steel	★	☆	★	☆	★								
M Stainless	★	☆	★	★	★								
K Cast iron	★		★	☆	★		☆						
N Non-ferrous							☆						
S Superalloys	★	☆	★				★						
H Hard materials													

★ : First choice
☆ : Second choice

Designation	Seat size	HAND	CW±0.05	RE	Coated					Uncoated				INSL	h	PSIRL	PSIRR	
					AH7025	AH725	AH8005	GH130	AH6235	KS05F								
SGS2-020	2	N	2	0.2	●	●	●	●	●	●					20	5	0°	0°
SGS2-020-6R	2	R	2	0.2	●	●	●	●	●	●					20	5	0°	6°
SGS2-020-6L	2	L	2	0.2	●	●	●	●	●	●					20	5	6°	0°
SGS2-020-15R	2	R	2	0.2	●	●	●	●	●	●					20	5	0°	15°
SGS2-020-15L	2	L	2	0.2	●	●	●	●	●	●					20	5	15°	0°
SGS3-020	3	N	3	0.2	●	●	●	●	●	●					20	5	0°	0°
SGS3-020-6R	3	R	3	0.2	●	●	●	●	●	●					20	5	0°	6°
SGS3-020-6L	3	L	3	0.2	●	●	●	●	●	●					20	5	6°	0°
SGS3-002-6R	3	R	3	0.02		●	●	●	●	●					19.8	5	0°	6°
SGS3-002-6L	3	L	3	0.02		●	●	●	●	●					19.8	5	6°	0°
SGS3-020-15R	3	R	3	0.2	●	●	●	●	●	●					20	5	0°	15°
SGS3-020-15L	3	L	3	0.2	●	●	●	●	●	●					20	5	15°	0°
SGS3-002-15R	3	R	3	0.02		●	●	●	●	●					19.8	5	0°	15°
SGS3-002-15L	3	L	3	0.02		●	●	●	●	●					19.8	5	15°	0°
SGS4-030	4	N	4	0.3	●	●	●	●	●	●					20	5	0°	0°
SGS5-030	5	N	5	0.3	●	●	●	●	●	●					25	5.5	0°	0°
SGS6-030	6	N	6	0.3	●	●	●	●	●	●					25	5.5	0°	0°
SGS8-040	8	N	8	0.4	●	●	●	●	●	●					30	6.7	0°	0°

● : Line up



DGE

External grooving (for high precision)

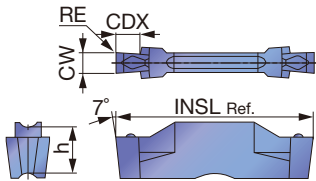

P	Steel	★	☆	☆				★				
M	Stainless	★	☆	★								
K	Cast iron	★		☆				☆				
N	Non-ferrous											
S	Superalloys	★	☆									
H	Hard materials											

★ : First choice
☆ : Second choice

Designation	Seat size	CW±0.02	RE	Coated			Cermet		CDX	INSL	h
				AH7025	AH725	GH130	NS9530				
DGE100-000	2	1	0		●	●	●		2.5	20	5
DGE130-000	2	1.3	0		●	●	●		2.5	20	5
DGE160-010	2	1.6	0.1	●	●	●	●		2.5	20	5
DGE185-010	2	1.85	0.1	●	●	●	●		3.5	20	5
DGE215-015	2	2.15	0.15	●	●	●	●		3.5	20	5

● : Line up

Caution

øDmax is limited as shown in the picture to the right according to the groove depth, G.D. Please refer to the following table.

G.D = Groove depth

Designation	Max. groove depth (mm)	øDmax (mm)				
		G.D. = 1	G.D. = 1.5	G.D. = 2	G.D. = 2.5	G.D. = 3
DGE100-000	2	∞	18.6	11.5	-	-
DGE130-000						
DGE160-010	3	∞	18.6	11.5	8.8	7
DGE185-010						
DGE215-015						

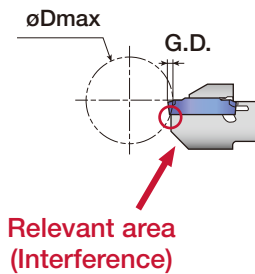

DGG

External grooving (for high precision)

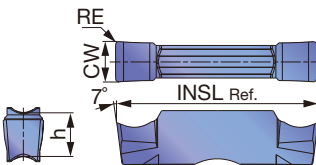

P	Steel	★		★						
M	Stainless	★								
K	Cast iron	★		☆		☆				
N	Non-ferrous					★				
S	Superalloys	★				☆				
H	Hard materials									

★ : First choice
☆ : Second choice

Designation	Seat size	CW±0.02	RE	Coated		Cermet	Uncoated	INSL	h
				AH7025	NS9530	KS05F			
DGG200-020	2	2	0.2	●	●	●		20	5
DGG300-020	3	3	0.2	●	●	●		20	5
DGG400-040	4	4	0.4	●	●	●		20	5
DGG500-040	5	5	0.4	●	●	●		25	5.5
DGG600-040	6	6	0.4	●	●	●		25	5.5

● : Line up

Reference pages: Toolholders → **G177 - G181**, Standard cutting conditions → **G190**

DGL

External grooving and parting

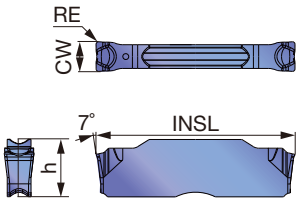

P	Steel	★	★	★					
M	Stainless	★	★	★					
K	Cast iron	★	★	★					
N	Non-ferrous								
S	Superalloys	★	★						
H	Hard materials								

★ : First choice
☆ : Second choice

Designation	Seat size	CW±0.05	RE	Coated			INSL	h
				AH7025	AH8005	AH6235		
DGL2-020	2	2	0.2	●	●	●	20	5
DGL3-025	3	3	0.25	●	●	●	20	5
DGL4-030	4	4	0.3	●	●	●	20	5
DGL5-030	5	5	0.3	●	●	●	25	5.5
DGL6-080	6	6	0.8	●	●	●	25	5.5

● : Line up

SGN

External grooving

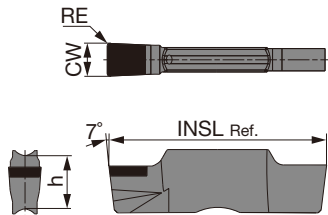

P	Steel								
M	Stainless								
K	Cast iron								
N	Non-ferrous								
S	Superalloys								
H	Hard materials	★							

★ : First choice
☆ : Second choice

Designation	Seat size	CW±0.025	RE	CBN			INSL	h	Edge prep.		
				BX360					No symbol	S	H
SGN200-020	2	2	0.2	●			20	5	○		
SGN200-020-S	2	2	0.2	●			20	5		○	
SGN200-020-H	2	2	0.2	●			20	5			○
SGN300-020	3	3	0.2	●			20	5	○		
SGN300-020-S	3	3	0.2	●			20	5		○	
SGN300-020-H	3	3	0.2	●			20	5			○
SGN400-020	4	4	0.2	●			20	5	○		
SGN400-020-S	4	4	0.2	●			20	5		○	
SGN400-020-H	4	4	0.2	●			20	5			○
SGN500-020-S	5	5	0.2	●			25	5.5		○	
SGN500-020-H	5	5	0.2	●			25	5.5			○

● : Line up

Edge preparations

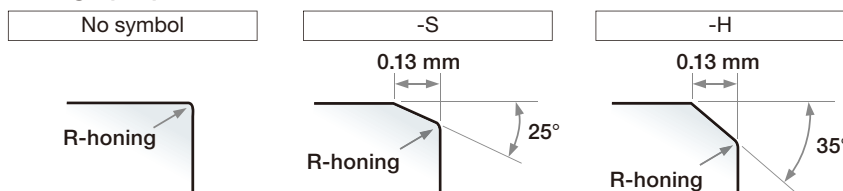

Reference pages: Toolholders → **G177 - G181**, Standard cutting conditions → **G190**



STANDARD CUTTING CONDITIONS

ISO	Workpiece material	Hardness	Priority	Grade	Cutting speed V _c (m/min)
P	Steel S45C, SCM435, etc. C45, 34CrMo4, etc.	< 300 HB	First choice	AH7025, AH725	50 - 180
		< 300 HB	Wear resistance	T9225, AH8005	80 - 300
		< 300 HB	Impact resistance	AH6235, GH130	50 - 120
		< 300 HB	Surface quality	NS9530	80 - 220
M	Stainless steel SUS303, SUS304, etc. X10CrNiS18-9, X5CrNi18-9, etc.	< 200 HB	First choice	AH7025, AH725	50 - 120
		< 200 HB	Wear resistance	AH8005	50 - 120
		< 200 HB	Impact resistance	AH6235, GH130	50 - 120
K	Grey cast iron FC250, etc. 250, etc.	-	First choice	T515	150 - 700
		-	Impact resistance	AH8005, AH7025, AH6235, GH130	50 - 180
	Ductile cast iron FCD450, etc. 450-10S, etc.	-	First choice	T515	150 - 300
		-	Impact resistance	AH8005, AH7025, AH6235, GH130	50 - 120
N	Aluminium alloys Si < 12%	-	First choice	TH10	100 - 500
		-	First choice	KS05F	100 - 600
S	Superalloys Inconel718, etc.	< HRC 40	First choice	AH8005	20 - 60
		< HRC 40	Impact resistance	AH7025, AH725, AH6235	20 - 40
	Titanium alloys Ti-6Al-4V, etc.	< HRC 40	First choice	KS05F	20 - 100
		< HRC 40	Impact resistance	AH7025, AH725	20 - 80
H	Hardened steel SCM435, SUJ2, etc. 34CrMo4, B1, etc.	> HRC 50	First choice	BX360	80 - 150

Please see page **G182**, **G183** for feed: *f* (mm/rev).



External toolholders for grooving and parting

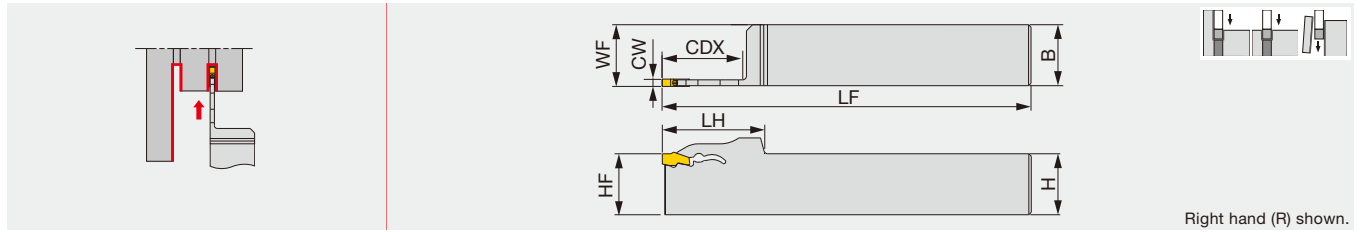

Right hand (R) shown.

Designation	CW	CDX	Seat size	H	B	LF	LH	HF	WF
QSER/L2020-2T26	2	26	2	20	20	125	36	20	20.1
QSER/L2020-2T33	2	33	2	20	20	125	42	20	20.1
QSER/L2020-3T26	3	26	3	20	20	125	36	20	20.3
QSER/L2020-3T33	3	33	3	20	20	125	42	20	20.3
QSER/L2020-4T33	4	33	4	20	20	125	42	20	20.4

QSP

Blades for external deep grooving and parting

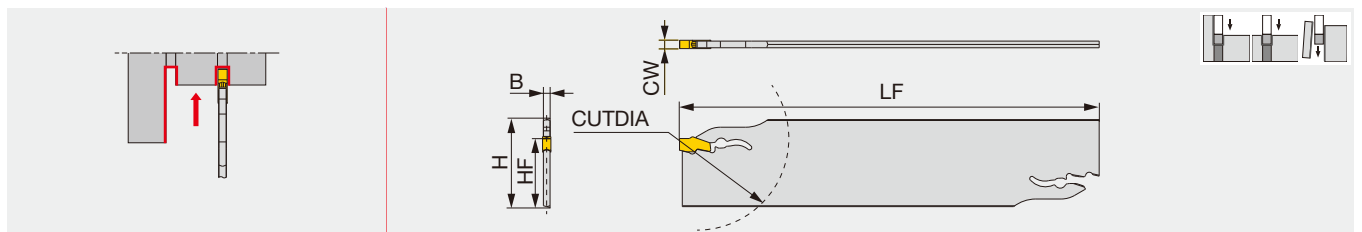

Designation	CW	CUTDIA	Seat size	H	B	LF	HF
QSP26-2D	2	50	2	26	1.8	150	21.4
QSP32-2D	2	66	2	32	1.8	150	24.8
QSP26-3D	3	75	3	26	2.4	150	21.4
QSP32-3D	3	120	3	32	2.4	150	24.8
QSP26-4D	4	80	4	26	3.2	150	21.4
QSP32-4D	4	120	4	32	3.2	150	24.9
QSP32-5D	5	120	5	32	4	150	24.9

CTBU

Tool block for QSP blades

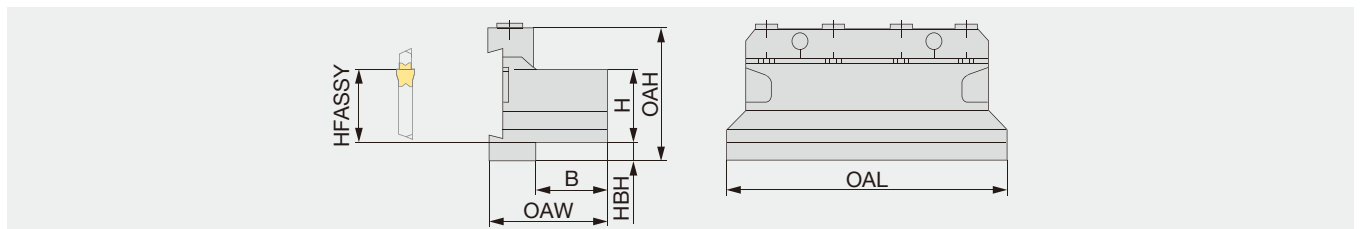

Designation	H	B	OAL	HFASSY	HBH	OAH	OAW	Blade (Optional)
CTBU20-26	20	21	86	20	9	43	38	QSP26...
CTBU20-32	20	19	100	20	13	50	38	QSP32...

SPARE PARTS

Designation	Clamp	Clamping screw	Wrench
QSER/L..., QSP...	-	-	QL-39
CTBU20-26	CT-86	CM6X30-S	P-5
CTBU25-26	CT-105	CM6X30-S	P-5
CTBU20-32	CT-100	CM6X30-S	P-5
CTBU25-32	CT-110	CM6X30-S	P-5
CTBU32-32	CT-110	CM6X30-S	P-5

Reference pages: QSER/L, QSP: Inserts → **G193**, Standard cutting conditions → **G194**

Parting-off and external grooving blade

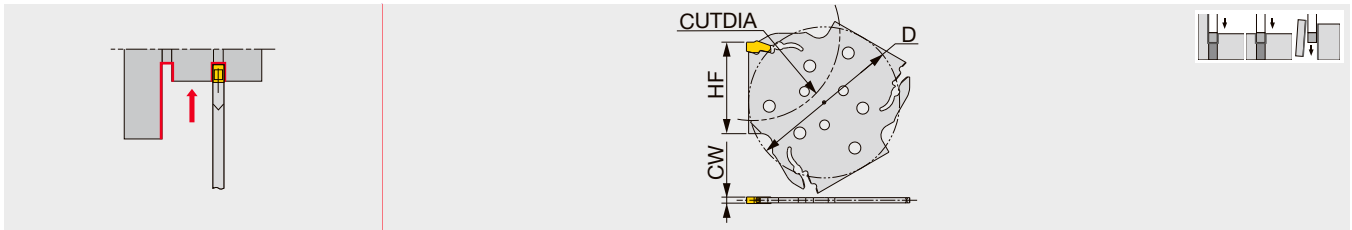

Designation	CW	Seat size	CUTDIA	HF	D
QSG52-2T	2	2	52	27	48.3
QSG82-2T	2	2	82	42	69.3
QSG52-3T	3	3	52	27	48.3
QSG82-3T	3	3	82	42	69.3
QSG52-4T	4	4	52	27	69.3
QSG82-4T	4	4	82	42	69.3



CHTBR/L

Tool block for QSG blade

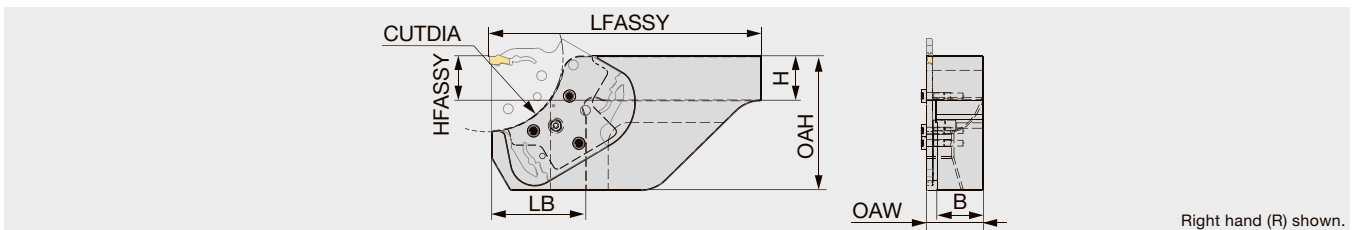

Designation	CUTDIA	H	B	LFASSY	HFASSY	OAH	OAW	LB
CHTBR/L2020-52	52	20	20.5	100	20	50	26.5	37
CHTBR/L2020-82	82	20	20.5	140	20	75	26.5	53

The blade clamping screw heads protrude out for as much as 3.1 mm over the insert cutting edge point. Maintain the clearance from the chucking device to avoid interference.

SPARE PARTS

Designation	Clamping screw	Grip	Torx bit	Wrench
QSG...	-	-	-	QL-39
CHTBR/L...	SR ISO 14580 M4X10	SW6-SD	BLDT20/S7	-

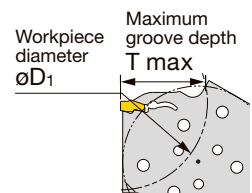

Maximum groove depth (T max) as function of workpiece diameter (øD1)

Designation	øD1																	
CHTBR/L****-D52	53	54	55	56	58	60	62	65	68	72	78	84	92	102	115	133	159	198
CHTBR/L****-D82	104	108	112	116	121	127	134	142	151	162	176	192	212	237	270	313	375	468
T max	21	20	19	18	17	16	15	14	13	12	11	10	9	8	7	6	5	4

Designation	øD1												
CHTBR/L****-D82	83	84	84	85	86	87	89	90	92	94	96	98	101
T max	34	33	32	31	30	29	28	27	26	25	24	23	22

INSERTS

QGM

External deep grooving and parting

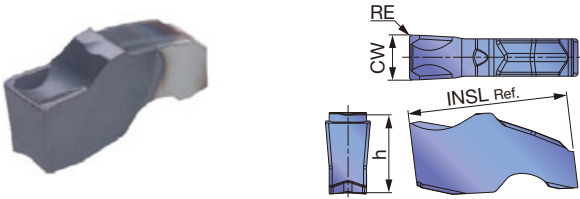

P	Steel	★																
M	Stainless	★																
K	Cast iron	★																
N	Non-ferrous																	
S	Superalloys	★																
H	Hard materials																	

★ : First choice

Designation	Seat size	CW±0.05	RE	Coated								INSL	h	
				AH7025										
QGM2-020	2	2	0.2	●									11	5.3
QGM3-020	3	3	0.2	●									11	5.3
QGM4-030	4	4	0.3	●									13	7.3
QGM5-030	5	5	0.3	●									13	7.3

● : Line up

QGS

External deep grooving and parting

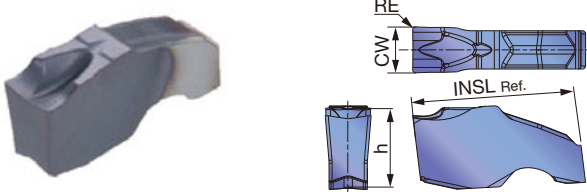

P	Steel	★																
M	Stainless	★																
K	Cast iron	★																
N	Non-ferrous																	
S	Superalloys	★																
H	Hard materials																	

★ : First choice

Designation	Seat size	CW±0.05	RE	Coated								INSL	h	
				AH7025										
QGS2-020	2	2	0.2	●									11	5.3
QGS3-020	3	3	0.2	●									11	5.3
QGS4-030	4	4	0.3	●									13	7.3
QGS5-030	5	5	0.3	●									13	7.3

● : Line up



STANDARD CUTTING CONDITIONS

ISO	Workpiece material	Hardness	Grade	Cutting speed Vc (m/min)
P	Steels C45, 34CrMo4, etc.	< 300 HB	AH7025	50 - 180
M	Stainless steel X10CrNiS18-9, etc.	< 200 HB	AH7025	50 - 120
K	Gray cast iron GG25, 250, etc.	-	AH7025	50 - 180
	Ductile cast irons GGG45, 450-10S, etc.	-	AH7025	50 - 120
S	Superalloys Inconel718, etc.	< HRC 40	AH7025	20 - 60
	Titanium alloys Ti-6Al-4V, etc.	< HRC 40	AH7025	20 - 80



External



Internal



Grooving



Threading



Parting-off

MEMO

Grade	A
Insert	B
Ext. Toolholder	C
Int. Toolholder	D
Threading	E
Grooving	F
Miniature tool	G
Milling cutter	H
Endmill	I
Drilling tool	J
Tooling System	K
User's Guide	L
Index	M

Alphanumeric Index

Turning Grooving

Designation	Product name	Page	Designation	Product name	Page
06IR□□ISO	ISO metric threading insert	E017	16ER115NPT	NPT threading insert	E025
06IRA55	55° angle threading insert	E015	16ER115NPT-B	NPT threading insert	E025
06IRA60	60° angle threading insert	E010	16ER115NPTF	NPTF threading insert	E026
08IRA55	55° angle threading insert	E015	16ER115NPT-M	NPT threading insert	E025
08IRA60	60° angle threading insert	E010	16ER8ACME	29° Trapezoidal threading insert	E029
10ER/L□□□B	Positive insert for back turning	B162, G091	16ER8NPT	NPT threading insert	E025
10ER/L300	Positive insert for back turning	B162, G091	16ER8NPT-B	NPT threading insert	E025
11ER□□ISO	ISO metric threading insert	E017	16ER8NPTF	NPTF threading insert	E026
11ERA55	55° angle threading insert	E015	16ER8RAPI	API Round threading insert	E030
11ERA60	60° angle threading insert	E010	16ER8RD-CB	API Round threading insert	E030
11IR/L□□□ISO	ISO metric threading insert	E017	16ER8UN-B	Unified threading insert	E022
11IR/LA60	60° angle threading insert	E010	16ER8UNJ	UNJ threading insert	E028
11IR□□ISO-B	ISO metric threading insert	E019	16ER8UN-M	Unified threading insert	E022
11IR□□ISO-M	ISO metric threading insert	E019	16ERA55	55° angle threading insert	E015
11IR□□PT	BSPT threading insert	E024	16ERA60	60° angle threading insert	E010
11IR□□UN	Unified threading insert	E021	16ERA60-B	60° angle threading insert	E011
11IR□□W	Whitworth threading insert	E023	16ERA60-M	60° angle threading insert	E011
11IR10MJ	MJ threading insert	E028	16ERAG55	55° angle threading insert	E015
11IRA55	55° angle threading insert	E015	16ERAG55-B	55° angle threading insert	E015
11IRA60-B	60° angle threading insert	E011	16ERAG60	60° angle threading insert	E010
11IRA60-M	60° angle threading insert	E011	16ERAG60-B	60° angle threading insert	E011
15GR/L...	Internal grooving insert	F162, G145	16ERAG60-M	60° angle threading insert	E011
16ELA60	60° angle threading insert	E010	16ERAG55	55° angle threading insert	E015
16ER/L□□□ISO	ISO metric threading insert	E018	16ERAG55-B	55° angle threading insert	E015
16ER/L□□□W	Whitworth threading insert	E023	16ERAG60-B	60° angle threading insert	E011
16ER/LG60	60° angle threading insert	E010	16ERAG60-M	60° angle threading insert	E011
16ER□□□□ISO	ISO metric threading insert	E018	16ERAG60-M	60° angle threading insert	E011
16ER□□□□ISO-B	ISO metric threading insert	E019	16ERG55	55° angle threading insert	E015
16ER□□□□ISO-M	ISO metric threading insert	E019	16ERG55-B	55° angle threading insert	E015
16ER□□□ACME	29° Trapezoidal threading insert	E029	16ERG60-B	60° angle threading insert	E011
16ER□□□ISO-B	ISO metric threading insert	E019	16ERG60-M	60° angle threading insert	E011
16ER□□□ISO-M	ISO metric threading insert	E019	16IR/L□□□ISO	ISO metric threading insert	E018
16ER□□□ACME	29° Trapezoidal threading insert	E029	16IR/LA60	60° angle threading insert	E010
16ER□□□ISO-B	ISO metric threading insert	E019	16IR/LG60	60° angle threading insert	E010
16ER□□□ISO-M	ISO metric threading insert	E019	16IR□□□□ISO-B	ISO metric threading insert	E019
16ER□□□NPT	NPT threading insert	E025	16IR□□□□ISO-M	ISO metric threading insert	E019
16ER□□□NPT-B	NPT threading insert	E025	16IR□□□ACME	29° Trapezoidal threading insert	E029
16ER□□□NPTF	NPTF threading insert	E026	16IR□□□ISO-B	ISO metric threading insert	E019
16ER□□□NPT-M	NPT threading insert	E025	16IR□□□ISO-M	ISO metric threading insert	E019
16ER□□□PT	BSPT threading insert	E024	16IR□□□NPT	NPT threading insert	E025
16ER□□□PT-B	BSPT threading insert	E024	16IR□□□NPT-M	NPT threading insert	E025
16ER□□□PT-M	BSPT threading insert	E024	16IR□□□PT	BSPT threading insert	E024
16ER□□□TR	30° Trapezoidal threading insert	E027	16IR□□□PT-B	BSPT threading insert	E024
16ER□□□UN	Unified threading insert	E021	16IR□□□PT-M	BSPT threading insert	E024
16ER□□□UN-B	Unified threading insert	E022	16IR□□□TR	30° Trapezoidal threading insert	E027
16ER□□□UNJ	UNJ threading insert	E028	16IR□□□UN	Unified threading insert	E021
16ER□□□UN-M	Unified threading insert	E022	16IR□□□UN-B	Unified threading insert	E022
16ER□□□W-B	Whitworth threading insert	E023	16IR□□□UN-M	Unified threading insert	E022
16ER□□□W-M	Whitworth threading insert	E023	16IR□□□W	Whitworth threading insert	E023
16ER□□RD-B	Round threading insert	E027	16IR□□□W-B	Whitworth threading insert	E023
16ER□□UN	Unified threading insert	E021	16IR□□□W-M	Whitworth threading insert	E023
16ER□□W	Whitworth threading insert	E023	16IR□□UN	Unified threading insert	E021
16ER10RAPI	API Round threading insert	E030	16IR□□W	Whitworth threading insert	E023
16ER10RD-CB	API Round threading insert	E030	16IR10RAPI	API Round threading insert	E030
			16IR10RD-CB	API Round threading insert	E030
			16IR115NPT	NPT threading insert	E025

Designation	Product name	Page	Designation	Product name	Page
16IR115NPT-B	NPT threading insert	E025	2QP-CCGW0602□□-LF	CBN insert, 80° rhombic, positive	B190
16IR115NPTF	NPTF threading insert	E026	2QP-CCGW0602□□SR	CBN insert, 80° rhombic, positive	B190
16IR115NPT-M	NPT threading insert	E025	2QP-CCGW09T3...	CBN insert, 80° rhombic, positive	B191
16IR□□NPT-B	NPT threading insert	E025	2QP-CCGW09T3□□-H	CBN insert, 80° rhombic, positive	B191
16IR14NPTF	NPTF threading insert	E026	2QP-CCGW09T3□□HC	CBN insert, 80° rhombic, positive	B191
16IR6RD-B	Round threading insert	E027	2QP-CCGW09T3□□-L	CBN insert, 80° rhombic, positive	B191
16IR8ACME	29° Trapezoidal threading insert	E029	2QP-CCGW09T3□□-LC	CBN insert, 80° rhombic, positive	B191
16IR8NPT	NPT threading insert	E025	2QP-CCGW09T3□□-LF	CBN insert, 80° rhombic, positive	B191
16IR8NPT-B	NPT threading insert	E025	2QP-CCGW09T3□□SR	CBN insert, 80° rhombic, positive	B191
16IR8NPTF	NPTF threading insert	E026	2QP-CCGW09T3□□WL	CBN insert, 80° rhombic, positive	B191
16IR8RAPI	API Round threading insert	E030	2QP-CCMW0602...	CBN insert, 80° rhombic, positive	B190
16IR8RD-CB	API Round threading insert	E030	2QP-CCMW09T3...	CBN insert, 80° rhombic, positive	B191
16IR8UN-B	Unified threading insert	E022	2QP-CNGA1204...	CBN insert, 80° rhombic, negative	B168, B169
16IR8UN-M	Unified threading insert	E022	2QP-CNGA1204□□-E	CBN insert, 80° rhombic, negative	B168
16IRA55	55° angle threading insert	E015	2QP-CNGA1204□□F	CBN insert, 80° rhombic, negative	B168
16IRA60-B	60° angle threading insert	E011	2QP-CNGA1204□□-H	CBN insert, 80° rhombic, negative	B169
16IRA60-M	60° angle threading insert	E011	2QP-CNGA1204□□HC	CBN insert, 80° rhombic, negative	B169
16IRAG55	55° angle threading insert	E015	2QP-CNGA1204□□-L	CBN insert, 80° rhombic, negative	B168
16IRAG55-B	55° angle threading insert	E015	2QP-CNGA1204□□-LC	CBN insert, 80° rhombic, negative	B168, B169
16IRAG60	60° angle threading insert	E010	2QP-CNGA1204□□-LF	CBN insert, 80° rhombic, negative	B168
16IRAG60-B	60° angle threading insert	E011	2QP-CNGA1204□□-LT	CBN insert, 80° rhombic, negative	B168
16IRAG60-M	60° angle threading insert	E011	2QP-CNGA1204□□SR	CBN insert, 80° rhombic, negative	B168, B169
16IRG55	55° angle threading insert	E015	2QP-CNGA1204□□WL	CBN insert, 80° rhombic, negative	B168
16IRG55-B	55° angle threading insert	E015	2QP-CNGM1204□□-HF	CBN insert, 80° rhombic, negative	B170
16IRG60-B	60° angle threading insert	E011	2QP-CNGM1204□□-HM	CBN insert, 80° rhombic, negative	B170
16IRG60-M	60° angle threading insert	E011	2QP-CNGM1204□□-HP	CBN insert, 80° rhombic, negative	B170
1QP-16ER60-□□□-SP	60° angle threading insert	E010	2QP-CNGM1204□□-HS	CBN insert, 80° rhombic, negative	B170
1QP-CCGT060204-NS	PCD insert, 80° rhombic, positive	B213	2QP-CNGM1204□□WL-HP	CBN insert, 80° rhombic, negative	B170
1QP-CCGT09T3□□-NS	PCD insert, 80° rhombic, positive	B213	2QP-CNGM1204□□WL-HS	CBN insert, 80° rhombic, negative	B170
1QP-CCGW03X1...	CBN insert, 80° rhombic, positive	B189	2QP-CNMA1204□□W	CBN insert, 80° rhombic, negative	B168
1QP-CCGW04T1...	CBN insert, 80° rhombic, positive	B189	2QP-CPGW0802...	CBN insert, 80° rhombic, positive	B192
1QP-CCMT060204	PCD insert, 80° rhombic, positive	B213	2QP-CPGW0903...	CBN insert, 80° rhombic, positive	B192
1QP-CCMT09T304	PCD insert, 80° rhombic, positive	B213	2QP-DCGT070204-HP	CBN insert, 55° rhombic, positive	B193
1QP-CNMM1204...	PCD insert, 80° rhombic, negative	B211	2QP-DCGT070204-HS	CBN insert, 55° rhombic, positive	B193
1QP-DCGT070204-NS	PCD insert, 55° rhombic, positive	B214	2QP-DCGT11T3□□-HP	CBN insert, 55° rhombic, positive	B194
1QP-DCGT11T3□□-NS	PCD insert, 55° rhombic, positive	B214	2QP-DCGT11T3□□-HS	CBN insert, 55° rhombic, positive	B194
1QP-EPGW03X1...	CBN insert, 75° rhombic, positive	B195	2QP-DCGW0702...	CBN insert, 55° rhombic, positive	B193
1QP-EPGW0401...	CBN insert, 75° rhombic, positive	B195	2QP-DCGW0702□□-L	CBN insert, 55° rhombic, positive	B193
1QP-TCMT110304	PCD insert, triangular, positive	B216	2QP-DCGW0702□□-LC	CBN insert, 55° rhombic, positive	B193
1QP-TNMM1604..	PCD insert, triangular, negative	B212	2QP-DCGW0702□□-LF	CBN insert, 55° rhombic, positive	B193
1QP-VBGT1604□□-NS	PCD insert, 35° rhombic, positive	B221	2QP-DCGW0702□□SR	CBN insert, 55° rhombic, positive	B193
1QP-VCGT1604□□-NS	PCD insert, 35° rhombic, positive	B220	2QP-DCGW11T3...	CBN insert, 55° rhombic, positive	B194
22ER/LN60	60° angle threading insert	E010	2QP-DCGW11T3□□-E	CBN insert, 55° rhombic, positive	B194
22ER□□ISO	ISO metric threading insert	E018, E019	2QP-DCGW11T3□□F	CBN insert, 55° rhombic, positive	B194
22ER□□ISO-B	ISO metric threading insert	E019	2QP-DCGW11T3□□-H	CBN insert, 55° rhombic, positive	B194
22ER□□TR	30° Trapezoidal threading insert	E027	2QP-DCGW11T3□□HC	CBN insert, 55° rhombic, positive	B194
22ER□□ACME	29° Trapezoidal threading insert	E029	2QP-DCGW11T3□□-L	CBN insert, 55° rhombic, positive	B194
22ER□□UN	Unified threading insert	E021	2QP-DCGW11T3□□-LC	CBN insert, 55° rhombic, positive	B194
22ER□□W	Whitworth threading insert	E023	2QP-DCGW11T3□□-LF	CBN insert, 55° rhombic, positive	B194
22ER5BAPI	API Buttress threading insert	E032	2QP-DCGW11T3□□SR	CBN insert, 55° rhombic, positive	B194
22ERN55	55° angle threading insert	E015	2QP-DCGW11T304-LT	CBN insert, 55° rhombic, positive	B194
22ERN60-B	60° angle threading insert	E011	2QP-DCMW0702...	CBN insert, 55° rhombic, positive	B193
22IR/LN60	60° angle threading insert	E010	2QP-DCMW11T3...	CBN insert, 55° rhombic, positive	B194
22IR□□ISO	ISO metric threading insert	E018	2QP-DNGA1104...	CBN insert, 55° rhombic, negative	B172
22IR□□TR	30° Trapezoidal threading insert	E027	2QP-DNGA1504...	CBN insert, 55° rhombic, negative	B172, B173
22IR□□ACME	29° Trapezoidal threading insert	E029	2QP-DNGA1504□□-E	CBN insert, 55° rhombic, negative	B172
22IR□□UN	Unified threading insert	E021	2QP-DNGA1504□□-H	CBN insert, 55° rhombic, negative	B173
22IR□□W	Whitworth threading insert	E023	2QP-DNGA1504□□HC	CBN insert, 55° rhombic, negative	B173
22IR5BAPI	API Buttress threading insert	E032	2QP-DNGA1504□□-L	CBN insert, 55° rhombic, negative	B172
22IR8RAPI-2T	API Round threading insert	E030	2QP-DNGA1504□□-LC	CBN insert, 55° rhombic, negative	B172, B173
22IRN55	55° angle threading insert	E015	2QP-DNGA1504□□-LF	CBN insert, 55° rhombic, negative	B172
22IRN60-B	60° angle threading insert	E011	2QP-DNGA1504□□-LT	CBN insert, 55° rhombic, negative	B172
27ER60ISO	ISO metric threading insert	E018	2QP-DNGA1504□□SR	CBN insert, 55° rhombic, negative	B172, B173
27ER60TR	30° Trapezoidal threading insert	E027	2QP-DNGA1504□□WJ	CBN insert, 55° rhombic, negative	B172
27ERZ60	60° angle threading insert	E010	2QP-DNGA1506...	CBN insert, 55° rhombic, negative	B175
27IR60ISO	ISO metric threading insert	E018	2QP-DNGA1506□□-H	CBN insert, 55° rhombic, negative	B175
27IRZ60	60° angle threading insert	E010	2QP-DNGA1506□□HC	CBN insert, 55° rhombic, negative	B175
2D-DCMT□□□□□□-ZF	AddY-axisTurn insert	C070	2QP-DNGA1506□□-L	CBN insert, 55° rhombic, negative	B175
2QP-CCGT060204-HP	CBN insert, 80° rhombic, positive	B190	2QP-DNGA1506□□-LC	CBN insert, 55° rhombic, negative	B175
2QP-CCGT060204-HS	CBN insert, 80° rhombic, positive	B190	2QP-DNGA1506□□-LF	CBN insert, 55° rhombic, negative	B175
2QP-CCGT09T3□□-HP	CBN insert, 80° rhombic, positive	B191	2QP-DNGA1506□□SR	CBN insert, 55° rhombic, negative	B175
2QP-CCGT09T3□□-HS	CBN insert, 80° rhombic, positive	B191	2QP-DNGM1504□□-HF	CBN insert, 55° rhombic, negative	B174
2QP-CCGT09T3□□WL-HP	CBN insert, 80° rhombic, positive	B191	2QP-DNGM1504□□-HM	CBN insert, 55° rhombic, negative	B174
2QP-CCGT09T3□□WL-HS	CBN insert, 80° rhombic, positive	B191	2QP-DNGM1504□□-HP	CBN insert, 55° rhombic, negative	B174
2QP-CCGW0602...	CBN insert, 80° rhombic, positive	B190	2QP-DNGM1504□□-HS	CBN insert, 55° rhombic, negative	B174
2QP-CCGW0602□□-L	CBN insert, 80° rhombic, positive	B190	2QP-DNGM150608-HP	CBN insert, 55° rhombic, negative	B175
2QP-CCGW0602□□-LC	CBN insert, 80° rhombic, positive	B190	2QP-DNGM150608-HS	CBN insert, 55° rhombic, negative	B175

Alphanumeric Index

Designation	Product name	Page	Designation	Product name	Page
2QP-FNGA1504...	CBN insert, 45° rhombic, negative	B176	3QP-TNGA1604□□-H	CBN insert, triangular, negative	B183
2QP-FNGA1504□□-H	CBN insert, 45° rhombic, negative	B176	3QP-TNGA1604□□HC	CBN insert, triangular, negative	B183
2QP-FNGA1504□□-L	CBN insert, 45° rhombic, negative	B176	3QP-TNGA1604□□-L	CBN insert, triangular, negative	B182
2QP-FNGA1504□□-LC	CBN insert, 45° rhombic, negative	B176	3QP-TNGA1604□□-LC	CBN insert, triangular, negative	B182, B183
2QP-FNGA1504□□-LF	CBN insert, 45° rhombic, negative	B176	3QP-TNGA1604□□-LF	CBN insert, triangular, negative	B182
2QP-FNGA1506...	CBN insert, 45° rhombic, negative	B177	3QP-TNGA1604□□SR	CBN insert, triangular, negative	B182, B183
2QP-FNGA1506□□-H	CBN insert, 45° rhombic, negative	B177	3QP-TNGA1604□□WG	CBN insert, triangular, negative	B182
2QP-FNGA1506□□-L	CBN insert, 45° rhombic, negative	B177	3QP-TNGA160408-E	CBN insert, triangular, negative	B182
2QP-FNGA1506□□-LC	CBN insert, 45° rhombic, negative	B177	3QP-TNGA160408-LT	CBN insert, triangular, negative	B182
2QP-FNGA1506□□-LF	CBN insert, 45° rhombic, negative	B177	3QP-TNGM1604□□-HF	CBN insert, triangular, negative	B184
2QP-FNGG1504□□-HP	CBN insert, 45° rhombic, negative	B176	3QP-TNGM1604□□-HM	CBN insert, triangular, negative	B184
2QP-FNGG1506□□-HP	CBN insert, 45° rhombic, negative	B177	3QP-TNGM1604□□-HP	CBN insert, triangular, negative	B184
2QP-GNGA1204...	CBN insert, 70° rhombic, negative	B178	3QP-TNGM1604□□-HS	CBN insert, triangular, negative	B184
2QP-GNGA1204□□-H	CBN insert, 70° rhombic, negative	B178	3QP-TPGN1103...	CBN insert, triangular, positive	B202
2QP-GNGA1204□□-HC	CBN insert, 70° rhombic, negative	B178	3QP-TPGN1603...	CBN insert, triangular, positive	B203
2QP-GNGA1204□□-L	CBN insert, 70° rhombic, negative	B178	3QP-TPGT1103□□-HP	CBN insert, triangular, positive	B200
2QP-GNGA1204□□-LC	CBN insert, 70° rhombic, negative	B178	3QP-TPGT1103□□-HS	CBN insert, triangular, positive	B200
2QP-GNGA1204□□-LF	CBN insert, 70° rhombic, negative	B178	3QP-TPGW0802...	CBN insert, triangular, positive	B198
2QP-GNGA1204□□SR	CBN insert, 70° rhombic, negative	B178	3QP-TPGW0902...	CBN insert, triangular, positive	B199
2QP-GNGG1204□□-HP	CBN insert, 70° rhombic, negative	B178	3QP-TPGW1102...	CBN insert, triangular, positive	B199
2QP-GNGG1204□□-HS	CBN insert, 70° rhombic, negative	B178	3QP-TPGW1103...	CBN insert, triangular, positive	B200
2QP-SNGA1204...	CBN insert, square, negative	B180	3QP-TPGW1103□□F	CBN insert, triangular, positive	B200
2QP-SNGA1204□□-H	CBN insert	B180	3QP-TPGW1103□□-H	CBN insert, triangular, positive	B200
2QP-SNGA1204□□-L	CBN insert, square, negative	B180	3QP-TPGW1103□□HC	CBN insert, triangular, positive	B200
2QP-SNGA1204□□-LF	CBN insert, square, negative	B180	3QP-TPGW1103□□-L	CBN insert, triangular, positive	B200
2QP-SNGA1204□□SR	CBN insert, square, negative	B180	3QP-TPGW1103□□-LC	CBN insert, triangular, positive	B200
2QP-SNGN0903...	CBN insert, square, negative	B180	3QP-TPGW1103□□-LF	CBN insert, triangular, positive	B200
2QP-SPGN0903...	CBN insert, square, positive	B196	3QP-TPGW1103□□SR	CBN insert, triangular, positive	B200
2QP-SPGW09T3...	CBN insert, square, positive	B195	3QP-TPGW1303...	CBN insert, triangular, positive	B201
2QP-SPGW1204...	CBN insert, square, positive	B196	3QP-TPGW1604...	CBN insert, triangular, positive	B202
2QP-SPMN0903...	CBN insert, square, positive	B196	3QP-TPGW1604□□-H	CBN insert, triangular, positive	B202
2QP-VBGT1103□□-HP	CBN insert, 35° rhombic, positive	B208	3QP-TPGW16T3...	CBN insert, triangular, positive	B201
2QP-VBGT1103□□-HS	CBN insert, 35° rhombic, positive	B208	3QP-TPMN1102...	CBN insert, triangular, positive	B202
2QP-VBGT1604□□-HP	CBN insert, 35° rhombic, positive	B209	3QP-TPMN1603...	CBN insert, triangular, positive	B203
2QP-VBGT1604□□-HS	CBN insert, 35° rhombic, positive	B209	3QP-TPMW080204	CBN insert, triangular, positive	B198
2QP-VBGW1102...	CBN insert, 35° rhombic, positive	B207	3QP-TPMW0902...	CBN insert, triangular, positive	B199
2QP-VBGW1103...	CBN insert, 35° rhombic, positive	B207	3QP-TPMW1102...	CBN insert, triangular, positive	B199
2QP-VBGW1103□□-L	CBN insert, 35° rhombic, positive	B207	3QP-TPMW1103...	CBN insert, triangular, positive	B200
2QP-VBGW1103□□-LC	CBN insert, 35° rhombic, positive	B207	3QP-TPMW1303...	CBN insert, triangular, positive	B201
2QP-VBGW1103□□-LF	CBN insert, 35° rhombic, positive	B207	3QP-TPMW1604...	CBN insert, triangular, positive	B202
2QP-VBGW1103□□SR	CBN insert, 35° rhombic, positive	B207	3QP-TPMW16T3...	CBN insert, triangular, positive	B201
2QP-VBGW1604...	CBN insert, 35° rhombic, positive	B208	3QP-WNGA0804...	CBN insert, 80° hexagonal, negative	B187
2QP-VBGW1604□□-H	CBN insert, 35° rhombic, positive	B208	3QP-WNGA080408-H	CBN insert, 80° hexagonal, negative	B187
2QP-VBGW1604□□HC	CBN insert, 35° rhombic, positive	B208	3QP-WNGA080408-L	CBN insert, 80° hexagonal, negative	B187
2QP-VBGW1604□□-L	CBN insert, 35° rhombic, positive	B208	3QP-WNGA080408-LF	CBN insert, 80° hexagonal, negative	B187
2QP-VBGW1604□□-LC	CBN insert, 35° rhombic, positive	B208	3QP-WNGA080408WL	CBN insert, 80° hexagonal, negative	B187
2QP-VBGW1604□□-LF	CBN insert, 35° rhombic, positive	B208	40D□□□□R/L	My-T Series face grooving and turning adapter	F214, F215
2QP-VBGW1604□□SR	CBN insert, 35° rhombic, positive	B208	40S □□□□R/L	My-T Series face grooving and turning adapter	F214, F215
2QP-VBMW1604...	CBN insert, 35° rhombic, positive	B208	4QP-CNGA1204...	CBN insert, 80° rhombic, negative	B168, B169
2QP-VCGW0802...	CBN insert, 35° rhombic, positive	B209	4QP-CNGA1204□□-H	CBN insert, 80° rhombic, negative	B169
2QP-VCGW1604...	CBN insert, 35° rhombic, positive	B209	4QP-CNGG1204□□-HF	CBN insert, 80° rhombic, negative	B170
2QP-VCGW1604□□-E	CBN insert, 35° rhombic, positive	B209	4QP-CNGG1204□□-HM	CBN insert, 80° rhombic, negative	B170
2QP-VCGW1604□□-H	CBN insert, 35° rhombic, positive	B209	4QP-CNMA1204□□W	CBN insert, 80° rhombic, negative	B168
2QP-VCGW1604□□-LT	CBN insert, 35° rhombic, positive	B209	4QP-DNGA1204...	CBN insert, 55° rhombic, negative	B172
2QP-VNGA1604...	CBN insert, 35° rhombic, negative	B186	4QP-DNGA1504□□-H	CBN insert, 55° rhombic, negative	B173
2QP-VNGA1604□□-H	CBN insert, 35° rhombic, negative	B186	4QP-DNGG1504□□-HF	CBN insert, 55° rhombic, negative	B174
2QP-VNGA1604□□HC	CBN insert, 35° rhombic, negative	B186	4QP-DNGG1504□□-HM	CBN insert, 55° rhombic, negative	B174
2QP-VNGA1604□□-L	CBN insert, 35° rhombic, negative	B186	4QP-SNGA1204...	CBN insert, square, negative	B180
2QP-VNGA1604□□-LC	CBN insert, 35° rhombic, negative	B186	4QP-SNGA1204□□-H	CBN insert, square, negative	B180
2QP-VNGA1604□□-LF	CBN insert, 35° rhombic, negative	B186	4QP-VNGA1604...	CBN insert, 35° rhombic, negative	B186
2QP-VNGA1604□□SR	CBN insert, 35° rhombic, negative	B186	4QP-VNGA1604□□-H	CBN insert, 35° rhombic, negative	B186
2QP-VNGM1604□□-HP	CBN insert, 35° rhombic, negative	B187	4QP-VNGG160408-HF	CBN insert, 35° rhombic, negative	B187
2QP-VNGM1604□□-HS	CBN insert, 35° rhombic, negative	B187	4QP-VNGG160408-HM	CBN insert, 35° rhombic, negative	B187
2QP-VNGM160408-HF	CBN insert, 35° rhombic, negative	B187	4QS-CNGA1204...	CBN insert, 80° rhombic, negative	B168, B169
2QP-VNGM160408-HM	CBN insert, 35° rhombic, negative	B187	4QS-CNGA1204□□-H	CBN insert, 80° rhombic, negative	B169
2QP-YNGA1604...	25° rhombic, negative insert	B188	4QS-CNGA1204□□HC	CBN insert, 80° rhombic, negative	B169
2QP-YNGA1604□□-L	25° rhombic, negative insert	B188	4QS-CNGA1204□□-LC	CBN insert, 80° rhombic, negative	B168, B169
2QP-YNGA1604□□-LC	25° rhombic, negative insert	B188	4QS-CNGA1204□□-LF	CBN insert, 80° rhombic, negative	B168
2QP-YNGA1604□□-LF	25° rhombic, negative insert	B188	4QS-CNGA1204□□SR	CBN insert, 80° rhombic, negative	B168, B169
2QP-YNGG1604□□-HP	25° rhombic, negative insert	B188	4QS-CNGA1204□□WL	CBN insert, 80° rhombic, negative	B168
30S□□□□R/L	My-T Series face grooving and turning adapter	F214, F215	4QS-CNGG1204□□-HF	CBN insert, 80° rhombic, negative	B170
3C-TCMT□□□□-TM	AddMultiTurn, AddY-axisTurn insert	C066, C069	4QS-CNGG1204□□-HM	CBN insert, 80° rhombic, negative	B170
3QP-TCGW0902...	CBN insert, triangular, positive	B197	4QS-CNGG1204□□-HP	CBN insert, 80° rhombic, negative	B170
3QP-TCGW1102...	CBN insert, triangular, positive	B198	4QS-CNGG1204□□-HS	CBN insert, 80° rhombic, negative	B170
3QP-TCGW16T3...	CBN insert, triangular, positive	B198	4QS-CNGG1204□□WL-HP	CBN insert, 80° rhombic, negative	B170
3QP-TNGA1604...	CBN insert, triangular, negative	B182, B183	4QS-DNGA1504...	CBN insert, 55° rhombic, negative	B172, B173
3QP-TNGA1604□□F	CBN insert, triangular, negative	B182	4QS-DNGA1504□□-H	CBN insert, 55° rhombic, negative	B173

Designation	Product name	Page
4QS-DNGA1504□□HC	CBN insert, 55° rhombic, negative	B173
4QS-DNGA1504□□-LC	CBN insert, 55° rhombic, negative	B172, B173
4QS-DNGA1504□□-LF	CBN insert, 55° rhombic, negative	B172
4QS-DNGA1504□□SR	CBN insert, 55° rhombic, negative	B172, B173
4QS-DNGG1504□□-HF	CBN insert, 55° rhombic, negative	B174
4QS-DNGG1504□□-HM	CBN insert, 55° rhombic, negative	B174
4QS-DNGG1504□□-HP	CBN insert, 55° rhombic, negative	B174
4QS-DNGG1504□□-HS	CBN insert, 55° rhombic, negative	B174
4QS-SNGA1204...	CBN insert, square, negative	B180
4QS-SNGA1204□□SR	CBN insert, square, negative	B180
4QS-VNGA1604...	CBN insert, 35° rhombic, negative	B186
4QS-VNGA1604□□-H	CBN insert, 35° rhombic, negative	B186
4QS-VNGA1604□□HC	CBN insert, 35° rhombic, negative	B186
4QS-VNGA1604□□-LC	CBN insert, 35° rhombic, negative	B186
4QS-VNGA1604□□-LF	CBN insert, 35° rhombic, negative	B186
4QS-VNGA1604□□SR	CBN insert, 35° rhombic, negative	B186
4QS-VNGG1604□□-HP	CBN insert, 35° rhombic, negative	B187
4QS-VNGG1604□□-HS	CBN insert, 35° rhombic, negative	B187
4QS-VNGG160408-HM	CBN insert, 35° rhombic, negative	B187
50D□□□□□R/L	My-T Series face grooving and turning adapter	F214, F215
50S□□□□□R/L	My-T Series face grooving and turning adapter	F214, F215
6GR/L...	Internal grooving insert	F162, G145
6C-TOMG□□□□□M-TM	AddMultiTurn insert	C065
6GMR...	Internal grooving insert	F161
6GMR100-015	Internal grooving INSERT	G144
6IR□□ISO	ISO metric threading insert	E017
6IR18NPT	NPT threading insert	E025
6IR19PT	BSPt threading insert	E024
6IR19W	Whitworth threading insert	E023
6IRA55	55° angle threading insert	E015
6IRA60	60° angle threading insert	E010
6QP-TNGA1604...	CBN insert, triangular, negative	B182, B183
6QP-TNGA1604□□-H	CBN insert, triangular, negative	B183
6QP-TNGG1604□□-HF	CBN insert, triangular, negative	B184
6QP-TNGG1604□□-HM	CBN insert, triangular, negative	B184
6QP-WNGA0804...	CBN insert, 80° hexagonal, negative	B187
6QS-TNGA1604...	CBN insert, triangular, negative	B182, B183
6QS-TNGA1604□□-H	CBN insert, triangular, negative	B183
6QS-TNGA1604□□HC	CBN insert, triangular, negative	B183
6QS-TNGA1604□□-LC	CBN insert, triangular, negative	B182, B183
6QS-TNGA1604□□-LF	CBN insert, triangular, negative	B182
6QS-TNGA1604□□SR	CBN insert, triangular, negative	B182, B183
6QS-TNGG1604□□-HF	CBN insert, triangular, negative	B184
6QS-TNGG1604□□-HP	CBN insert, triangular, negative	B184
6QS-TNGG1604□□-HS	CBN insert, triangular, negative	B184
6QS-TNGG160408-HM	CBN insert, triangular, negative	B184
6QS-WNGA0804...	CBN insert, 80° hexagonal, negative	B187
6QS-WNGA080408-H	CBN insert, 80° hexagonal, negative	B187
6QS-WNGA080408-LF	CBN insert, 80° hexagonal, negative	B187
6QS-WNGA080408-WL	CBN insert, 80° hexagonal, negative	B187
6QS-WXGQ0403□□SPR/L	MiniForce-Turn insert, 80° trigon, positive, double-sided	B210
6QS-WXGU0403□□R/L-HP	MiniForce-Turn insert, 80° trigon, positive, double-sided	B210
6V-TOMG□□□□□F-TSF	AddMultiTurn insert	C065
7GR/L...	Internal grooving insert	F162, G145
7GMR...	Internal grooving insert	F161, G144
8GR/L...	Internal grooving insert	F162, G145
8GMR...	Internal grooving insert	F161, G144
9GR/L...	Internal grooving insert	F162, G145
9GMR...	Internal grooving insert	F161, G144

A

A/E□□□-SNGR□□-D...	Internal grooving toolholder	F159, G142
A/E□□□-STCIR/L□□-D...	AddInternalCut internal grooving toolholder	F120, G140
A□□□-ACLNR/L0904-...	ISO Eco-Turn boring bar, steel shank	D030
A□□□-ACLNR/L12-...	TurningA boring bar, steel shank	D030
A□□□-ADUNR/L1104-...	ISO-EcoTurn boring bar, steel shank	D072
A□□□-ADUNR/L□□-...	TurningA boring bar, steel shank	D072
A□□□-ASKNR/L12-...	TurningA boring bar, steel shank	D044
A□□□-ATFNR/L16-...	TurningA boring bar, steel shank	D051
A□□□-AVUNR/L16-...	TurningA boring bar, steel shank	D075
A□□□-AWLNR/L□□-...	TurningA boring bar, steel shank	D033
A□□□-AWLNR/L0604-...	ISO-EcoTurn boring bar, steel shank	D033
A□□□-PCLNR/L□□-...	StreamJet-Bar boring bar, steel shank	D025
A□□□-PDUNR/L...	StreamJet-Bar boring bar, steel shank	D069
A□□□-PDZNR/L15-...	StreamJet-Bar boring bar, steel shank	D088
A□□□-PSKNR/L12-...	StreamJet-Bar boring bar, steel shank	D043
A□□□-PTFNR/L1104-...	ISO-EcoTurn boring bar, steel shank	D049

Designation	Product name	Page
A□□□-PTFNR/L16-...	StreamJet-Bar boring bar, steel shank	D049
A□□□-PTUNR/L□□-...	StreamJet-Bar boring bar, steel shank	D067
A□□□-PTUNR/L1104-...	ISO-EcoTurn boring bar, steel shank	D067
A□□□-PVUNR/L1204-...	ISO-EcoTurn boring bar, steel shank	D074
A□□□-PVUNR/L16-...	StreamJet-Bar boring bar, steel shank	D074
A□□□-PWLNR/L□□-...	StreamJet-Bar boring bar, steel shank	D031
A□□□-PWLNR/L0604-...	ISO-EcoTurn boring bar, steel shank	D031
A□□□-SCLCR/L□□-...	StreamJet-Bar boring bar, steel shank	D014
A□□□-SCLPR/L□□-...	StreamJet-Bar boring bar, steel shank	D018
A□□□-SCLXR/L□□-...	MiniForce-Turn boring bar, steel shank	D021
A□□□-SDQCR/L□□-...	StreamJet-Bar boring bar, steel shank	D076
A□□□-SDQPR/L07-...	StreamJet-Bar boring bar, special alloy steel	D078
A□□□-SDUCR/L...	StreamJet-Bar boring bar, steel shank	D056
A□□□-SDUPR/L07-...	StreamJet-Bar boring bar, special alloy steel	D058
A□□□-SDXNR/L07-...	MiniForce-Turn boring bar, steel shank	D036
A□□□-SDZCR/L□□-...	StreamJet-Bar boring bar, steel shank	D085
A□□□-SDZXR/L07-...	MiniForce-Turn boring bar, steel shank	D086
A□□□-SEXPR/L□□-...	StreamJet-Bar boring bar, steel shank	D034
A□□□-SEZPR/L03-...	StreamJet-Bar boring bar, steel shank	D084
A□□□-STFPR/L□□-D...	Internal grooving toolholder	G142
A□□□-SSKPR□□-...	StreamJet-Bar boring bar, steel shank	D041
A□□□-STCIR/L□□-D...	AddInternalCut Internal grooving toolholder	G140
A□□□-STFCR/L1103-...	StreamJet-Bar boring bar, steel shank	D045
A□□□-STUPR/L...	StreamJet-Bar boring bar, steel shank	D046
A□□□-STUPR/L...	StreamJet-Bar boring bar, steel shank	D053
A□□□-SVJBR/L11-...	StreamJet-Bar boring bar, steel shank	D038
A□□□-SVJCR/L08-...	StreamJet-Bar boring bar, steel shank	D039
A□□□-SVQCR/L□□-...	StreamJet-Bar boring bar, steel shank	D079
A□□□-SVQCR/L□□-...	StreamJet-Bar boring bar, steel shank	D081
A□□□-SVUBR/L□□-...	StreamJet-Bar boring bar, steel shank	D059
A□□□-SVUCR/L□□-...	StreamJet-Bar boring bar, steel shank	D061
A□□□-SVZBR/L□□-...	StreamJet-Bar boring bar, steel shank	D087
A□□□-SWLXR/L□□-...	MiniForce-Turn boring bar, steel shank	D023
A□□□-SWUBR/L03-...	StreamJet-Bar boring bar, steel shank	D052
A□□□-SXUOR/L□□-D...	TungBoreMini boring bar, steel shank	D065
A□□□-SYQBR/L11-...	Y-Pro Series boring bar, steel shank	D083
A□□M-FLER/L3	TungT-Clamp internal grooving and threading toolholder	E064, F152
A070□□-SEXPR...	TinyMini-Turn Indexable boring bar	G106
A07055-SEZPR03-3	TinyMini-Turn Indexable boring bar	G106
A12M-SVZCR/L08-D160	StreamJet-Bar boring bar, steel shank	D088
A16Q-SYUBR/L11-D200	Y-Pro Series boring bar, steel shank	D064
A32S-PTUNR/L16	boring bar, steel shank	D067
ACLNR/L□□□□X-□□-CHP-MC	TungCap external toolholder with high pressure coolant nozzle	C019
ACLNR/L...	ISO-EcoTurn / TurningA external toolholder	C015
ADJNR/L...	ISO-EcoTurn/TurningA toolholder	C034
ADJNR/L□□□□X-15-CHP-MC	TungCap external toolholder with high pressure coolant nozzle	C038
ADPNN...	TurningA external toolholder	C108
ADQNR/L...	ISO-EcoTurn/TurningA toolholder	C092
ARGNR/L2525M12-A	TurningA external toolholder	C060
ASBNR/L...	TurningA external toolholder	C101
ASDNN...	TurningA external toolholder	C074
ASKNR/L...	TurningA external toolholder	C084
ASSNR/L...	TurningA external toolholder	C080
ATFNR/L...	TurningA external toolholder	C088
ATGNR/L...	TurningA external toolholder	C057
ATJNR/L...	TurningA external toolholder	C032
ATQNR/L...	TurningA external toolholder	C091
ATXOR/L...	AddMultiTurn external toolholder	C065
AVC-SET...	BoreMeiser center height set up device	E059, D092
AVJNR/L...	ISO-EcoTurn/TurningA external toolholder	C041
AVQNR/L...	ISO-EcoTurn/TurningA external toolholder	C094
AVVNN...	ISO-EcoTurn/TurningA external toolholder	C050
AWLNR/L□□□□X-08-CHP-MC	TungCap external toolholder with high pressure coolant nozzle	C027
AWLNR/L...	ISO-EcoTurn/TurningA external toolholder	C024

B

B-CER/L□□□16	External threading toolholder for Swiss lathes	E039, F093, G163
BC-SER12K16	External threading toolholder for Swiss lathes	E040, G163
BLC□□-...	Sleeve for boring bar	D095
BLM□□□-...	Sleeve for boring bar	D093, D095
BLM□□-...	Sleeve for boring bar	D093, D095
BLS16-□□C	Sleeve for boring bar	D094

Alphanumeric Index

Designation	Product name	Page	Designation	Product name	Page
BLS16-...	Sleeve for boring bar	D094	C6PDUNL17100-1104-CHP	TungCap lever-lock external/facing toolholder with high pressure coolant nozzle	D071
B-SER□□□16	External threading toolholder for Swiss lathes	E039, G163	C6SDNCN00125-13-Y-CHP	AddY-axisTurn Y-axis turning toolholder	C070
C					
C□□□-CTFPR/L...	Boring bar, carbide shank	D047	C6-SH-D□□-5D-E-CHP	BoreMeister PSC compatible adapter with carbide core	D091
C□ACLNN...	TungCap TurningA external toolholder	C016	C6STECN00125-29-Y-CHP	AddY-axisTurn Y-axis turning toolholder	C069
C□ACLNR/L...	TungCap TurningA external toolholder	C016	C6TBK-32R/L	Toolholder with TungCap connection for parting-off blade	F225, F230
C□ADJNR/L...	TungCap TurningA external toolholder	C034	CAEFR/L-□T04-CHP	TungCut external and face grooving adapter for high pressure coolant	F021, F175
C□ADNNN...	TungCap TurningA external toolholder	C071	CAER/L-□T...	TungCut external grooving and turning adapter	F025
C□ADQNR/L...	TungCap TurningA external toolholder	C092	CAER/L-□T□□-CHP	TungCut external grooving and parting adapter for high pressure coolant	F021
C□ADUNR/L...	TungCap TurningA external toolholder	C109	CAER/L-□T□□-MD	TungCut external grooving and parting adapter	F021
C□AVJNR/L...	TungCap TurningA external toolholder	C042	CAFR/L-□T□□-...	TungCut face grooving and turning adapter	F179
C□AWLNR/L...	TungCap TurningA external toolholder	C024	CAFR/L-□T□□-□□□□□□-CHP	TungCut face grooving and turning adapter for high pressure coolant	F175
C□CER/L□□□□□-16ER	TungCap external threading toolholder	E036	CCBS□□-32	My-T Series tool block for CCH blade	F252, F256
C□CER/L□□□□□-16ERN	TungCap external threading toolholder	E036	CCGT...	80° rhombic, positive, ISO insert	B116
C□CHFVN□□□□□-CHP	Toolholder with TungCap connection for perpendicularly-mounted adapter, with high pressure coolant	F024, F049, F063, F178, F203	CCGT□□-01	80° rhombic, positive, ISO insert	B112
C□CHFVR/L□□□□□N	TungCut toolholder with TungCap connection for adapter, perpendicularly mounted	F027, F181	CCGT□□-AL	80° rhombic, positive, ISO insert	B116
C□CHSN□□□□□-CHP	Toolholder with TungCap connection for adapter, with high pressure coolant	F024, F049, F063, F178, F203	CCGT□□-F01	80° rhombic, positive, ISO insert	B112
C□CHSR/L□□□□□N	TungCut toolholder with TungCap connection for adapter	F027, F181	CCGT□□-F-JS	80° rhombic, positive, ISO insert	B112
C□PCLNR/L...	TungCap external toolholder	C017	CCGT□□-FN-JP	80° rhombic, positive, ISO insert	B112
C□PCLNR/L...CHP	TungCap external/profiling toolholder with high pressure coolant nozzle	C021	CCGT□□-FN-JS	80° rhombic, positive, ISO insert	B112
C□PDJNR/L□□□□□-1104-CHP	TungCap external/profiling toolholder with high pressure coolant nozzle	C039	CCGT□□-FR-L-J10	80° rhombic, positive, ISO insert	B113
C□PDJNR/L□□□□□-15-CHP	TungCap external/profiling toolholder with high pressure coolant nozzle	C039	CCGT□□-FR/L-W08	80° rhombic, positive, ISO insert	B114
C□PDJNR/L...	TungCap TurningA external toolholder	C038	CCGT□□-JS	80° rhombic, positive, ISO insert	B112
C□PVJNR/L□□□□□-1204-CHP	TungCap external/profiling toolholder with high pressure coolant nozzle	C044	CCGT□□-N-JS	80° rhombic, positive, ISO insert	B112
C□PVJNR/L□□□□□-16-CHP	TungCap external/profiling toolholder with high pressure coolant nozzle	C044	CCGT□□-R/L	80° rhombic, positive, ISO insert	B116
C□PWLNR/L□□□□□-0604-CHP	TungCap external/facing toolholder with high pressure coolant nozzle	C028	CCGT□□-R/L-W08	80° rhombic, positive, ISO insert	B114
C□PWLNR/L□□□□□-08-CHP	TungCap external/facing toolholder with high pressure coolant nozzle	C028	CCGT□□-R/L-W15	80° rhombic, positive, ISO insert	B114
C□-SH-D□□-...	Tool adapter with PSC connection	F123	CCGT□□-R/L-W20	80° rhombic, positive, ISO insert	B115
C□-SH-D□□-5D-E-CHP	BoreMeister PSC compatible adapter with carbide core	E058	CCGW...	80° rhombic, positive, ISO insert	B117
C□STCF□□□□□-18-CHP	TetraMini-Cut external grooving toolholder for high pressure coolant	F050	CCGW0602□□-DIA	PCD insert, 80° rhombic, positive	B213
C□STCR/L□□□□□-18-CHP	External grooving and threading toolholder with high pressure coolant capability	E043, F050	CCGW09T3□□-DIA	PCD insert, 80° rhombic, positive	B213
C□SVJCR/L...	TungCap external toolholder	C048	CCH32-...	My-T Series external grooving and parting blade	F256
C□SVVCN...	TungCap external toolholder	C052	CCH32-W...	My-T Series external grooving and parting blade	F252
C3CEL18065-16ERB-CHP	TungCap external threading toolholder	E037	CCLNR/L...	DimpleFX external toolholder	C022
C3CEL22040-16ERN-B	TungCap external threading toolholder	E037	CCMT□□-23	80° rhombic, positive, ISO insert	B116
C3PTUNL□□□□□-16-CHP	TungCap external toolholder with high pressure coolant nozzle	C110	CCMT□□-24	80° rhombic, positive, ISO insert	B117
C3SCLCL180□□-09-CHP	TungCap external toolholder with high pressure coolant nozzle	C031	CCMT□□-CM	80° rhombic, positive, ISO insert	B115
C3SDJCR/L22040-11-CHP	TungCap external toolholder with high pressure coolant nozzle	C046	CCMT□□-PF	80° rhombic, positive, ISO insert	B113
C3SDUCL□□□□□-11-CHP	TungCap external toolholder with high pressure coolant nozzle	C111	CCMT□□-PM	80° rhombic, positive, ISO insert	B117
C3STCF18□□□-18-CHP	External grooving and threading toolholder with high pressure coolant capability	E043, F050	CCMT□□-PS	80° rhombic, positive, ISO insert	B115
C3SVUCL18065-11-CHP	TungCap external toolholder with high pressure coolant nozzle	C112	CCMT□□-PSF	80° rhombic, positive, ISO insert	B113
C4ATJNR/L...	TungCap external toolholder	C032	CCMT□□-PSS	80° rhombic, positive, ISO insert	B115
C4AVQNR/L27050-16N	TungCap TurningA external toolholder	C094	CCMT□□-SW	80° rhombic, positive, ISO insert	B116
C4PTJNR/L27050-1104N	TungCap external toolholder	C033	CCMT□□-TM	80° rhombic, positive, ISO insert	B115
C4-SH-D□□-2.5D-CHP	BoreMeister PSC compatible adapter with steel core	D091, E058, F123	CCMT□□-TSF	80° rhombic, positive, ISO insert	B113
C4-SH-D40-3D-CHP	BoreMeister PSC compatible adapter with steel core	E058, D091	CCMT0602□□-DIA	PCD insert, 80° rhombic, positive	B213
C4STCR/L27050-27-CHP	TetraForce-Cut external grooving toolholder for high pressure coolant	F064	CCMT09T3□□-DIA	PCD insert, 80° rhombic, positive	B213
C6ACMNN...	TungCap TurningA external toolholder	C105	CCMW...	80° rhombic, positive, ISO insert	B116
C6-D□□-L□□□-9D-C	BoreMeister PSC adapter with anti vibration, L/D = 9	D090, E059, F123	CDJNR/L...	DimpleFX external/profiling toolholder	C040
C6PCLNL17100-12-CHP	TungCap internal toolholder with high pressure coolant nozzle	D026	CDNNN2525M1507-RD	DimpleFX external toolholder	C072
C6PCMNN00130-12-CHP	TungCap lever-lock external/facing toolholder with high pressure coolant nozzle	C106	CER/L□□□□□□□DT	External threading toolholder	E036, F093
C6PDMNL00130-1104-CHP	TungCap lever-lock external/facing toolholder with high pressure coolant nozzle	C107	CER□□□□□□□T	External threading toolholder	E036, F093
			CGD...	My-T Series grooving insert	F119
			CGER/L□□□□□-□T...	TungCut external deep grooving and parting toolholder	F020, G179
			CGEUR/L□□□□□-□T...	TungCut 45° external undercutting toolholder	F262
			CGIUR/L□□□-□T□□-D□□□	TungCut 45° internal undercutting toolholder	F263
			CGIUR/L□□□-□T□□-D□□□-15A	TungCut toolholder for aluminium wheel profiling	F263
			CGP□□-□D	TungCut external deep grooving and parting blade	F229
			CGP□□-□S	TungCut external deep grooving and parting blade	F229
			CGP...	TungCut external deep grooving and parting blade	G180
			CGP32-□D-CHP	TungCut external deep grooving and parting blade for high pressure coolant	F231
			CGP32-8S-CL	TungCut external deep grooving and parting blade	F229
			CGSSR/L□□□□-...	My-T Series monoblock toolholder for external grooving and parting	F080
			CGSSR/L□□□□-□□D	My-T Series monoblock toolholder for external deep grooving and parting	F080
			CGWSR/L...	My-T Series toolholder for adapter	F081, F216
			CGWSR/L□□□□-□□GR/L	My-T Series adapter set for external grooving and parting	F079
			CGWSR/L□□□□-CGDR/L...	My-T Series external grooving and parting toolholder	F118
			CGWSR/L□□□□-FLR/L□GP	My-T Series external grooving toolholder	F115
			CGWSR/L□□□□-FLR/L5TP	My-T Series face grooving and turning	F223
			CGWSR/L□□□□-W...	My-T Series monoblock toolholder for external grooving and parting	F077

Designation	Product name	Page
CGWSR/L□□□□-W□□GR/L	My-T Series adapter set for external grooving and parting	F078
CGWSR/L□□□□-W□□GR/L-L	My-T Series adapter set for external deep grooving and parting	F078
CGWSR/L□□□□-W□□-L	My-T Series monoblock toolholder for external deep grooving and parting	F077
CGWSR□□□□-8	My-T Series external grooving and parting toolholder	F118
CGWTR/L...	My-T Series toolholder for adapter	F081, F216
CGWTR/L□□□□-□□GL/R	My-T Series adapter set for external grooving and parting	F079
CGWTR/L0040-FL/R3NP	Internal grooving and turning toolholder	F167
CGXR/L...	Internal grooving toolholder	F164
CGXR/L16SC	Internal grooving toolholder	F164
CHFVR/L...	TungCut shank for adapter, perpendicularly mounted	F026, F180
CHFVR/L□□□□-CHP	Shank for perpendicularly-mounted adapter for high pressure coolant	F023, F048, F062, F177, F202
CHGP□□-□T	TungCut parting-off and external grooving blade	F234, G180
CHGP...	TungCut external deep grooving and parting adaptor	G180
CHP-CONNECTOR...	connector	C115
CHP-COPPER-SEAL...	Seal washer	C115, F266
CHP-ELBOW-90-□□-□□UNF	Connector elbow	F266
CHP-ELBOW-90-...	Connector elbow	C115
CHP-HOSE-□□□□-...	TungTurn-Jet connecting hose	C115, F266
CHP-NIPPLE-G1/8-7/16UNF	connector	C115, F266
CHSNR2525M0507-RD	DimpleFX external toolholder	C083
CHSR/L...	TungCut shank for adapter	F026, F180
CHSR/L□□□□-CHP	Shank for adapter for high pressure coolant	F022, F047, F061, F176, F201
CHSR/L□□□□-CHP-MC	Shank for adapter for high pressure coolant	F022, F047, F061, F176, F201
CHTBR/L□□□□-...	Tool block for QSG, CHGP blades	F226, F235
CHTBR/L2020-...	AddForceCut toolblock for QSG blade	G192
CLVOR-□□M...	External threading toolholder for chaser	E053
CNGA...	80° rhombic, negative, ISO insert	B064
CNGA-10R-3E	API Round chaser insert	E031
CNGA1204□□-DIA	PCD insert, 80° rhombic, negative	B211
CNGA1204□□-QBN	CBN insert, 80° rhombic, negative	B171
CNGA-5B75-3E	API Round chaser insert	E033
CNGA-8R-3E	API Round chaser insert	E031
CNGD...	80° rhombic, negative, ISO insert	B065
CNGG□□-28	80° rhombic, negative, ISO insert	B061
CNGG□□-01	80° rhombic, negative, ISO insert	B056
CNGG□□R/L-C	80° rhombic, negative, ISO insert	B056
CNGG□□R/L-P	80° rhombic, negative, ISO insert	B060
CNGN...	80° rhombic, negative, ISO insert	B065
CNGN12□□-E/T1	80° rhombic, negative, ISO insert	B065, C023
CNGR/L□□□□15	Internal grooving toolholder	F160
CNGR/L...	Internal grooving toolholder	G143
CNMA...	80° rhombic, negative, ISO insert	B063
CNMA□□W	80° rhombic, negative, ISO insert	B064
CNMG...	80° rhombic, negative, ISO insert	B058
CNMG□□-11	80° rhombic, negative, ISO insert	B056
CNMG□□-17	80° rhombic, negative, ISO insert	B056
CNMG□□-27	80° rhombic, negative, ISO insert	B061
CNMG□□-28	80° rhombic, negative, ISO insert	B061
CNMG□□-33	80° rhombic, negative, ISO insert	B061
CNMG□□-37	80° rhombic, negative, ISO insert	B061
CNMG□□-38	80° rhombic, negative, ISO insert	B061
CNMG□□-AFW	80° rhombic, negative, ISO insert	B056
CNMG□□-AM	80° rhombic, negative, ISO insert	B058
CNMG□□-AS	80° rhombic, negative, ISO insert	B054
CNMG□□-ASW	80° rhombic, negative, ISO insert	B060
CNMG□□-CB	80° rhombic, negative, ISO insert	B056
CNMG□□-CF	80° rhombic, negative, ISO insert	B055
CNMG□□-CH	80° rhombic, negative, ISO insert	B062
CNMG□□-CM	80° rhombic, negative, ISO insert	B059
CNMG□□-DM	80° rhombic, negative, ISO insert	B058
CNMG□□E-FW	80° rhombic, negative, ISO insert	B056
CNMG□□E-SM	80° rhombic, negative, ISO insert	B59
CNMG□□E-SS	80° rhombic, negative, ISO insert	B055
CNMG□□E-SW	80° rhombic, negative, ISO insert	B059
CNMG□□E-TF	80° rhombic, negative, ISO insert	B054
CNMG□□E-TM	80° rhombic, negative, ISO insert	B057
CNMG□□E-TSF	80° rhombic, negative, ISO insert	B054
CNMG□□E-ZF	80° rhombic, negative, ISO insert	B054

Designation	Product name	Page
CNMG□□E-ZM	80° rhombic, negative, ISO insert	B057
CNMG□□-FW	80° rhombic, negative, ISO insert	B056
CNMG□□-HMM	80° rhombic, negative, ISO insert	B060
CNMG□□-HRF	80° rhombic, negative, ISO insert	B055
CNMG□□-HRM	80° rhombic, negative, ISO insert	B059
CNMG□□-NM	80° rhombic, negative, ISO insert	B058
CNMG□□-NS	80° rhombic, negative, ISO insert	B054
CNMG□□-PM	80° rhombic, negative, ISO insert	B057
CNMG□□-PS	80° rhombic, negative, ISO insert	B054
CNMG□□R/L-S	80° rhombic, negative, ISO insert	B060
CNMG□□-SA	80° rhombic, negative, ISO insert	B060
CNMG□□-SDM	80° rhombic, negative, ISO insert	B059
CNMG□□-SF	80° rhombic, negative, ISO insert	B055
CNMG□□-SH	80° rhombic, negative, ISO insert	B062
CNMG□□-SM	80° rhombic, negative, ISO insert	B059
CNMG□□-SS	80° rhombic, negative, ISO insert	B055
CNMG□□-SW	80° rhombic, negative, ISO insert	B059
CNMG□□-TA	80° rhombic, negative, ISO insert	B060
CNMG□□-TF	80° rhombic, negative, ISO insert	B054
CNMG□□-TH	80° rhombic, negative, ISO insert	B061
CNMG□□-THS	80° rhombic, negative, ISO insert	B062
CNMG□□-TM	80° rhombic, negative, ISO insert	B057
CNMG□□-TQ	80° rhombic, negative, ISO insert	B060
CNMG□□-TS	80° rhombic, negative, ISO insert	B054
CNMG□□-TSF	80° rhombic, negative, ISO insert	B054
CNMG□□-ZF	80° rhombic, negative, ISO insert	B054
CNMG□□-ZM	80° rhombic, negative, ISO insert	B057
CNMM□□-57	80° rhombic, negative, ISO insert	B062
CNMM□□-65	80° rhombic, negative, ISO insert	B062
CNMM□□-TRS	80° rhombic, negative, ISO insert	B062
CNMM□□-TU	80° rhombic, negative, ISO insert	B063
CNMM□□-TUS	80° rhombic, negative, ISO insert	B063
CNMM1204□□-DIA	PCD insert, 80° rhombic, negative	B211
CNMN...	80° rhombic, negative, ISO insert	B065
CNR/L...	Internal grooving and threading toolholder	E056
CNR/L□□□□□16	Internal grooving and threading toolholder	E056, F154
CPGA0902□□-DIA	PCD insert, 80° rhombic, positive	B213
CPGA0902□□-QBN	CBN insert, 80° rhombic, positive	B192
CPGT□□R/L-W15	80° rhombic, positive, ISO insert	B118
CPGT□□R/L-W20	80° rhombic, positive, ISO insert	B118
CPMT□□-24	80° rhombic, positive, ISO insert	B120
CPMT□□-CM	80° rhombic, positive, ISO insert	B119
CPMT□□-PF	80° rhombic, positive, ISO insert	B117
CPMT□□-PM	80° rhombic, positive, ISO insert	B120
CPMT□□-PS	80° rhombic, positive, ISO insert	B119
CPMT□□-PSF	80° rhombic, positive, ISO insert	B117
CPMT□□-PSS	80° rhombic, positive, ISO insert	B118
CPMT□□-TM	80° rhombic, positive, ISO insert	B116
CPMT□□-TSF	80° rhombic, positive, ISO insert	B119
CPMT120408	80° rhombic, positive, ISO insert	B119
CPMW...	80° rhombic, positive, ISO insert	B120
CR-10R-3E	Chaser insert, API Round	E031
CR-10R-3I	Chaser insert, API Round	E031
CR-11.5NPT-4E	Chaser insert, NPT	E026
CR-11.5NPT-4I	Chaser insert, NPT	E026
CR-5B75-2I-W24	Chaser insert, API Buttress	E034
CR-5B75-3E #...	Chaser insert, API Buttress	E034
CR-5B75-3I	Chaser insert, API Buttress	E033
CR-5B75-4E	Chaser insert, API Buttress	E033
CR-8NPT-4E	Chaser insert, NPT	E026
CR-8NPT-4I	Chaser insert, NPT	E026
CR-8R-3E	Chaser insert, API Round	E031
CR-8R-3E #...	Chaser insert, API Round	E032
CR-8R-3I	Chaser insert, API Round	E031
CSSNR/L2525M1207-RD	DimpleFX external toolholder	C082
CTBF□□-45	TungCut tool block for CGP blade	F230
CTBU□□-...	Tool block for QSP, CGP blades	F225, F230, G181, G191
CTBU□□-□□□-□-CHP	EasyMulti-Cut tool block with high pressure coolant nozzle	F169
CTBU...	TungCut toolblock for CGP blade	G181, G191
CTBU25-32-CHP	Tool block for CGP-CHP blade for high pressure coolant	F231, G182
CTD...	Grooving insert	F117
CTEFR/L□□□□-□T04	TungCut external face grooving toolholder	F017, F174
CTER/L□□□□-□T...	TungCut external grooving and parting toolholder	F014
CTER/L□□□□-□□□-CHP	TungCut external grooving toolholder for high pressure coolant	F016
CTER/L□□□□-6T□□-15A	TungCut toolholder for aluminium wheel profiling	F262

Alphanumeric Index

Designation	Product name	Page	Designation	Product name	Page
CTFR/L2525-□□□-...	TungCut face grooving and turning toolholder	F172	DNGG□□R/L	55° rhombic, negative, ISO insert	B072
CTFVR/L2525-□□□-...	TungCut toolholder for face grooving and turning, perpendicular	F173	DNGG□□R/L-P	55° rhombic, negative, ISO insert	B072
CTIFR/L□□□-□□□□-...	TungCut face grooving toolholder	F182	DNGN...	55° rhombic, negative, ISO insert	B074
CTIR/L□□□-□□□□-...	TungCut internal grooving toolholder	F126	DNMA...	55° rhombic, negative, ISO insert	B073
CTWR/L□□□□□-...	External grooving and parting toolholder	F117	DNMG...	55° rhombic, negative, ISO insert	B070
CVVNN...	DimpleFX external toolholder	C051	DNMG□□□-11	55° rhombic, negative, ISO insert	B068
CXMU□□R/L-TS	80° rhombic, positive, ISO insert	B120	DNMG□□□-17	55° rhombic, negative, ISO insert	B068
D			DNMG□□□-27	55° rhombic, negative, ISO insert	B072
D□□-L□□□□-□□□-□-□-□-□-□	Anti-vibration bars with through coolant for interchangeable turning heads	E057, F122	DNMG□□□-28	55° rhombic, negative, ISO insert	B072
D□□-L□□□□-...	BoreMeister anti-vibration bar	D090	DNMG□□□-33	55° rhombic, negative, ISO insert	B072
D□□-L□□□□-10D-C	BoreMeister anti-vibration bars with through coolant	E057	DNMG□□□-37	55° rhombic, negative, ISO insert	B072
D□□-L□□□□-4D-SH	BoreMeister steel shank for internal turning, with through coolant	D091, E057, F123	DNMG□□□-38	55° rhombic, negative, ISO insert	B072
D□□-L□□□□-7D-C	BoreMeister anti-vibration bars with through coolant	E057	DNMG□□□-AM	55° rhombic, negative, ISO insert	B069
DCET□□MFN-JSP	55° rhombic, positive, ISO insert	B123	DNMG□□□-AS	55° rhombic, negative, ISO insert	B066
DCET□□MFR/L-JPP	55° rhombic, positive, ISO insert	B123	DNMG□□□-CB	55° rhombic, negative, ISO insert	B068
DCET□□MFR/L-JRP	55° rhombic, positive, ISO insert	B123	DNMG□□□-CF	55° rhombic, negative, ISO insert	B068
DCGT...	55° rhombic, positive, ISO insert	B124	DNMG□□□-CH	55° rhombic, negative, ISO insert	B073
DCGT□□□-01	55° rhombic, positive, ISO insert	B121	DNMG□□□-CM	55° rhombic, negative, ISO insert	B071
DCGT□□□-AL	55° rhombic, positive, ISO insert	B124	DNMG□□□-DM	55° rhombic, negative, ISO insert	B070
DCGT□□□-F-01	55° rhombic, positive, ISO insert	B121	DNGN□□□-T1-W	55° rhombic, negative, ISO insert	B074
DCGT□□□-FN-JP	55° rhombic, positive, ISO insert	B121	DNMG□□□-E-FW	55° rhombic, negative, ISO insert	B068
DCGT□□□-FN-JS	55° rhombic, positive, ISO insert	B121	DNMG□□□-E-SM	55° rhombic, negative, ISO insert	B070
DCGT□□□-FR/L-J10	55° rhombic, positive, ISO insert	B122	DNMG□□□-E-SS	55° rhombic, negative, ISO insert	B067
DCGT□□□-N-JS	55° rhombic, positive, ISO insert	B121	DNMG□□□-E-SW	55° rhombic, negative, ISO insert	B071
DCGT□□□R/L	55° rhombic, positive, ISO insert	B124	DNMG□□□-E-TF	55° rhombic, negative, ISO insert	B066
DCGT□□□R/L-W10	55° rhombic, positive, ISO insert	B122	DNMG□□□-E-TM	55° rhombic, negative, ISO insert	B069
DCGT□□□R/L-W15	55° rhombic, positive, ISO insert	B122	DNMG□□□-E-TSF	55° rhombic, negative, ISO insert	B067
DCGT□□□R-L-J10	55° rhombic, positive, ISO insert	B122	DNMG□□□-E-ZF	55° rhombic, negative, ISO insert	B066
DCGW...	55° rhombic, positive, ISO insert	B125	DNMG□□□-E-ZM	55° rhombic, negative, ISO insert	B069
DCGW0702□□□-DIA	PCD insert, 55° rhombic, positive	B214	DNMG□□□-FW	55° rhombic, negative, ISO insert	B068
DCGW11T3□□□-DIA	PCD insert, 55° rhombic, positive	B214	DNMG□□□-HMM	55° rhombic, negative, ISO insert	B071
DCLNR/L...	D-type external toolholder	C017	DNMG□□□-HRF	55° rhombic, negative, ISO insert	B067
DCMT□□□-23	55° rhombic, positive, ISO insert	B125	DNMG□□□-HRM	55° rhombic, negative, ISO insert	B070
DCMT□□□-24	55° rhombic, positive, ISO insert	B125	DNMG□□□R/L-S	55° rhombic, negative, ISO insert	B072
DCMT□□□-CM	55° rhombic, positive, ISO insert	B124	DNMG□□□-NM	55° rhombic, negative, ISO insert	B070
DCMT□□□-PF	55° rhombic, positive, ISO insert	B122	DNMG□□□-NS	55° rhombic, negative, ISO insert	B066
DCMT□□□-PM	55° rhombic, positive, ISO insert	B125	DNMG□□□-PM	55° rhombic, negative, ISO insert	B069
DCMT□□□-PS	55° rhombic, positive, ISO insert	B124	DNMG□□□-PS	55° rhombic, negative, ISO insert	B066
DCMT□□□-PSF	55° rhombic, positive, ISO insert	B121	DNMG□□□-SA	55° rhombic, negative, ISO insert	B071
DCMT□□□-PSS	55° rhombic, positive, ISO insert	B124	DNMG□□□-SDM	55° rhombic, negative, ISO insert	B070
DCMT□□□-TM	55° rhombic, positive, ISO insert	B124	DNMG□□□-SF	55° rhombic, negative, ISO insert	B067
DCMT□□□-TSF	55° rhombic, positive, ISO insert	B122	DNMG□□□-SH	55° rhombic, negative, ISO insert	B073
DCMT0702□□□-DIA	PCD insert, 55° rhombic, positive	B214	DNMG□□□-SM	55° rhombic, negative, ISO insert	B070
DCMT11T3□□□-DIA	PCD insert, 55° rhombic, positive	B214	DNMG□□□-SS	55° rhombic, negative, ISO insert	B067
DCMW...	55° rhombic, positive, ISO insert	B125	DNMG□□□-SW	55° rhombic, negative, ISO insert	B071
DDJNR/L...	D-type external toolholder	C035	DNMG□□□-TF	55° rhombic, negative, ISO insert	B066
DDQNR/L...	D-type external toolholder	C093	DNMG□□□-TH	55° rhombic, negative, ISO insert	B073
DGE□□□□-...	TungCut grooving insert	F036, G188	DNMG□□□-THS	55° rhombic, negative, ISO insert	B073
			DNMG□□□-TM	55° rhombic, negative, ISO insert	B069
DGG□□□□-...	TungCut grooving insert	F036, F140, F193, F243, G188	DNMG□□□-TQ	55° rhombic, negative, ISO insert	B071
DGIM2-020	TungCut grooving insert	F132	DNMG□□□-TS	55° rhombic, negative, ISO insert	B067
DGIS2-020	TungCut grooving insert	F133	DNMG□□□-TSF	55° rhombic, negative, ISO insert	B066
DGL□□□-...	TungCut grooving insert	F035, F135, F194, F243, G189	DNMG□□□-ZF	55° rhombic, negative, ISO insert	B066
			DNMG□□□-ZM	55° rhombic, negative, ISO insert	B069
DGM□□□-...	TungCut grooving insert	F032, F135, F190, F239, G185	DNMM□□□-57	55° rhombic, negative, ISO insert	B073
			DNMM1504□□□-DIA	PCD insert, 55° rhombic, negative	B211
DGM□□□□□□□-□R/L	TungCut grooving insert	F032, F135, F190, F239, G185	DPMT□□□-PS	55° rhombic, positive, ISO insert	B126
DGS□□□-...	TungCut grooving insert	F034, F137, F192, F241, G184	DRG NR/L2525M12	D-type external toolholder	C060
			DSB NR/L...	D-type external toolholder	C102
DGS□□□□□□□-□R/L	TungCut grooving insert	F034, F137, F192, F241, G184	DSD NN...	D-type external toolholder	C074
DNGA...	55° rhombic, negative, ISO insert	B074	DSKNR/L...	D-type external toolholder	C084
DNGA1504□□□-DIA	PCD insert, 55° rhombic, negative	B211	DSS NR/L...	D-type external toolholder	C080
DNGA1504□□□-QBN	CBN insert, 55° rhombic, negative	B174			
DNGD...	55° rhombic, negative, ISO insert	B074	DTA□□□□-...	TungCut grooving insert	F041, F143, F196, F265
DNGG□□□-01	55° rhombic, negative, ISO insert	B068	DTE□□□-...	TungCut grooving insert	F038, F140, F189, F245
			DTE□□□□-...	TungCut grooving insert	F037, F139, F188, F244
			DTF□□-040-R/L	TungCut grooving insert	F187
			DTF NR/L...	D-type external toolholder	C088
			DTGNR/L...	D-type external toolholder	C058
			DTI□□□□-...	TungCut grooving insert	F133
			DTI□□-040	TungCut grooving insert	F134
			DTIU□□□□-...	TungCut grooving insert	F040, F142, F196, F264
			DTM□□-...	TungCut grooving insert	F037, F134, F188, F244

Designation	Product name	Page
DTR□-...	TungCut grooving insert	F039, F141, F195
DTR□□□-...	TungCut grooving insert	F039, F141, F194
DTX□-...	TungCut grooving insert	F038, F132, F187, F245
DWLNRL/...	TungTurn external / facing toolholder	C025
DXGU□□MFR/LE-JRP	MiniForce-Turn insert, 55° rhombic, positive, double-sided	B126
DXGU□□MFR/L-JS	MiniForce-Turn insert, 55° rhombic, positive, double-sided	B127
DXGU□□MFR/L-JSS	MiniForce-Turn insert, 55° rhombic, positive, double-sided	B126
DXGU□□MFR/L-JTS	MiniForce-Turn insert, 55° rhombic, positive, double-sided	B127
DXGU□□MR/L-JSS	MiniForce-Turn insert, 55° rhombic, positive, double-sided	B126
DXGU□□MR/L-JTS	MiniForce-Turn insert, 55° rhombic, positive, double-sided	B127
DXGU□□R/L-SS	MiniForce-Turn insert, 55° rhombic, positive, double-sided	B126
DXGU□□R/L-TS	MiniForce-Turn insert, 55° rhombic, positive, double-sided	B127
DXMU□□R/L-TS	MiniForce-Turn insert, 55° rhombic, positive, double-sided	B127

E		
E□□□-SCLCR/L□□-...	StreamJet-Bar boring bar, carbide shank	D014
E□□□-SCLPR/L□□-...	StreamJet-Bar boring bar, carbide shank	D018
E□□□-SCLXR/L□□-...	MiniForce-Turn boring bar, carbide shank	D021
E□□□-SDQCR/L□□-...	StreamJet-Bar boring bar, carbide shank	D076
E□□□-SDQPR/L07-...	StreamJet-Bar boring bar, carbide shank	D078
E□□□-SDUPR/L07-...	StreamJet-Bar boring bar, carbide shank	D058
E□□□-SDXXR/L07-...	MiniForce-Turn boring bar, carbide shank	D036
E□□□-SDZCR/L□□-...	StreamJet-Bar boring bar, carbide shank	D085
E□□□-SDZXR/L07-...	MiniForce-Turn boring bar, carbide shank	D086
E□□□-SEXPR/L□□-...	StreamJet-Bar boring bar, carbide shank	D034
E□□□-SEZPR/L03-...	StreamJet-Bar boring bar, carbide shank	D084
E□□□-SNGR□□-D...	Internal grooving toolholder	G142
E□□□-STCIR/L□□-D...	AddInternalCut Internal grooving toolholder	G140
E□□□-STFCR/L1103-...	StreamJet-Bar boring bar, carbide shank	D045
E□□□-STFPR/L...	StreamJet-Bar boring bar, carbide shank	D046
E□□□-STUPR/L...	StreamJet-Bar boring bar, carbide shank	D053
E□□□-SVQBR/L□□-...	StreamJet-Bar boring bar, carbide shank	D079
E□□□-SVQCR/L□□-...	StreamJet-Bar boring bar, carbide shank	D081
E□□□-SVUBR/L□□-...	StreamJet-Bar boring bar, carbide shank	D059
E□□□-SVUCR/L□□-...	StreamJet-Bar boring bar, carbide shank	D061
E□□□-SWLXR/L□□-...	MiniForce-Turn boring bar, carbide shank	D023
E□□□-SWUBR/L03-...	StreamJet-Bar boring bar, carbide shank	D052
E□□□-SXUOR/L□□-D...	TungBoreMini boring bar, carbide shank	D065
E□□□-SYQBR/L11-...	Y-Pro Series boring bar, carbide shank	D083
E□□□-SYUBR/L11-...	Y-Pro Series boring bar, carbide shank	D064
E070□□-SEXPR...	TinyMini-Turn Indexable boring bar	G106
E07055-SEZPR03-5	TinyMini-Turn Indexable boring bar	G106
EFPR/L□-□-...	EasyMulti-Cut face grooving blade	F169
EGM4-030	EasyMulti-Cut grooving insert	F171
EPGT□□F-JS	75° rhombic, positive, ISO insert	B128
EPGT□□FL-J08	75° rhombic, positive, ISO insert	B128
EPGT□□FR/L-W08	75° rhombic, positive, ISO insert	B129
EPGT□□-JS	75° rhombic, positive, ISO insert	B128
EPGT□□L-J08	75° rhombic, positive, ISO insert	B128
EPGT□□R/L-W08	75° rhombic, positive, ISO insert	B129
EPGW0401□-DIA	PCD insert, 75° rhombic, positive	B214
ETFR/L□□□□-□T□□-...	EasyMulti-Cut face grooving and turning toolholder	F168
ETFR□□□□-□T□□-□□□□-CHP	EasyMulti-Cut face grooving toolholder for high pressure coolant	F168
ETX□-...	EasyMulti-Cut grooving and turning insert	F170

F		
FLASRL-1616M3	TungT-Clamp external groovingand threading toolholder	E050, F091
FLEX□□R/L	My-T Series grooving insert	F116, F167, F223
FLG-3M□□□R/L-CB	TungT-Clamp grooving insert	F092, F153
FLSR/L-□□□□M3	TungT-Clamp external groovingand threading toolholder	E050, F091
FLT-3R/L-CB	60° angle threading insert	E014
FLT-3R/LC-HCB	60° angle threading insert	E014
FLT-3R/L-HCB	60° angle threading insert	E014
FNMG□□E-TM	45° rhombic, negative insert	B075
FNMG□□E-TSF	45° rhombic, negative insert	B075
FPGN□□□□□-□□T...	TungHeavyGroove external wide profile grooving toolholder	F095, G138
FPGR□□□□□-□□T...	TungHeavyGroove external grooving toolholder	F095

G		
G□□-L□□□-...	BoreMeister anti-vibration bar, carbide shank	D090
G□□-L□□□-10D-E	BoreMeister anti-vibration bars with through coolant	E057
GBR/L32...	External grooving insert	F100, F156

Designation	Product name	Page
GBR/L43...	External grooving insert	F101, F157
GBR/L43□□□R	External grooving insert	F102, F158
GE...	My-T Series grooving insert	F087, F148, F218, F259
GE□□-AL	My-T Series grooving insert	F090, F150, F220, F261
GE□□R/L	My-T Series grooving insert	F089, F258
GF...	My-T Series grooving insert	F088, F149, F219, F259
GIR/L□□□□-02	Internal grooving insert	F165
GLR/L...	External grooving insert	F104
GN...	My-T Series grooving insert	F089, F150, F220, F260
GNMG□□E-TM	70° rhombic, negative insert	B075
GNMG□□E-TSF	70° rhombic, negative insert	B075
GOR/L...	External grooving insert	F103
GR...	My-T Series grooving insert	F088, F149, F219
GT...	My-T Series grooving insert	F087, F148, F218, F260
GTGN-16...	Grooving insert	F094, F155
GX-□□□□R/LE	External wide grooving toolholder	F105
GX-2525R/LF	My-T Series face grooving toolholder	F222
GX-2525R/LI	Internal grooving toolholder	F166

H		
HNGD...	Hexagonal, negative, ISO insert	B111
HS□□-FLER3W	TungT-Clamp internal grooving and threading head	E063, F152
HS□□-LNFR-53	Head exchangeable internal threading head	E064
HS□□-LNFR-54API	Head exchangeable internal threading head	E065
HS□□-MTHOR-...	Head exchangeable internal threading head	E065
HSRNR/L...	External toolholder. H-type	C104

J		
J10ER/L□□□□B	J10E insert (edge preparation)	B161, G090
J10ER/L□□□□BF	J10E insert (shrap edge)	B161, G090
J10ER/L...	J10E insert (edge preparation)	G090
JBBR...	TinyMini-Turn solid carbide bar	G101
JBBS□□□-□-...	TinyMini-Turn sleeve for external coolant supply	E062, G107
JBBS□□□□-□-...	TinyMini-Turn sleeve for external coolant supply	E062, G107
JBBS□□□□-□-1100C	TinyMini-Turn sleeve for internal coolant supply	E062, G108
JBBS□□□□-□-1100C-4N	TinyMini-Turn sleeve for internal coolant supply with 4 coolant holes	E060, G107
JBBS□□□□-□-1100C	TinyMini-Turn sleeve for internal coolant supply	E062, G108
JBBS□□□□-□-1100C-4N	TinyMini-Turn sleeve for internal coolant supply with 4 coolant holes	E060, G107
JBBS□□□□-□-180C-4N	TinyMini-Turn sleeve for internal coolant supply with 4 coolant holes	E060, G107
JBBS127-4-L80C-4N	TinyMini-Turn sleeve for internal coolant supply with 4 coolant holes	E060, G107
JBBSA...C	TinyMini-Turn collet-chuck sleeve	G108, E061
JBCR...	TinyMini-Turn solid carbide bar	G100
JBFR/L...	TinyMini-Turn solid carbide bar	G104
JBGR/L...	TinyMini-Turn solid carbide bar	G103
JBIR...	TinyMini-Turn solid carbide bar	E060, G102
JBPR...	TinyMini-Turn solid carbide bar	G099
JBRR...	TinyMini-Turn solid carbide bar	G105
JBSR07200200-D060	TinyMini-Turn solid carbide bar	G105
JBTR/L...	TinyMini-Turn solid carbide bar	G098
JBUR...	TinyMini-Turn solid carbide bar	G100
JCCN200F...	J-Series grooving insert	F109
JCCR/L200F...	J-Series grooving insert	F109
JCCWSR/L□□□□K2	J-Series external deep grooving and parting tolholder	F109
JCGN200F	J-Series grooving insert	F110
JCGN200FR/L	J-Series grooving insert	F110
JCGSSR/L...	My-T Series external grooving and parting toolholder	F081
JCGWSR/L□□□□K2	J-Series grooving and parting toolholder	F110
JCTER/L□□□□□□□T...	TungCut external grooving and parting toolholder	F018, F232, G178
JCTER/L□□□□□X2T□□-CHP	TungCut external grooving and parting toolholder for high pressure coolant	F019, F233, G180
JCTER/L2012H...	TungCut external grooving and parting toolholder	G179
JPDJ2XR/L...	MiniForce-Turn external/profiling toolholder	G060
JPVJ2NR/L□□□□X1204	J-Series external toolholder	G069
JPVJ2XR/L...	MiniForce-Turn external/profiling toolholder	G066
JPWL2XR/L...	MiniForce-Turn external/facing toolholder	G047
JS□□□□-STCFL18	TetraMini-Cut face grooving toolholder	F199, G147

Alphanumeric Index

Designation	Product name	Page
JS□□□□-STCL18	TetraMini-Cut external grooving and threading toolholder	E042, F046, G116, G155
JS□□□-SDUXL07	MiniForce-Turn external/profiling toolholder	C113, G082
JS□□□-SEL16	External threading toolholder for Swiss lathes	E039, G163
JS□□□-STCFL18	TetraMini-Cut face grooving toolholder with round shank	F199, G147
JS□□□-STCL18	External grooving and threading toolholder	E042, F046, G116, G155
JS□□□-SVUXL09	MiniForce-Turn external/profiling toolholder	C114
JS□□□-SXXL09	DuoJust-Cut threading toolholder	E048, F073, G160, G172
JS□□H-SEXPR...	Boring bar, steel shank	D035
JS□□K-SDUCL...	J-Series external toolholder	G081
JS□□K-TBL3	J-Series external toolholder	G084
JS□□K-TGL3	J-Series external grooving toolholder	F111, G133
JS□□K-TTL3	J-Series external grooving toolholder	E049, G165
JS□□-SEL16	TungThread External threading toolholder	G163
JSCGCR/L...	J-Series external toolholder	G78
JSCL2CR/L...	J-Series external toolholder	G042
JSCL2CR1212X09B-CHP	TungTurn-Jet toolholder with high pressure coolant nozzle	G042
JSCL2CR1616X09-CHP	TungTurn-Jet toolholder with high pressure coolant nozzle	G042
JSCLCR/L...	J-Series external toolholder	G043
JSCLCR□□□□09-F15	J-Series stepped head toolholder	G043
JSDFCR/L...	J-Series external toolholder	G80
JSDJ2CR/L...	J-Series external toolholder	G054
JSDJ2CR/L1212□□□-CHP	TungTurn-Jet toolholder with high pressure coolant nozzle	G056
JSDJ2CR□□□□□□□-CHP	TungTurn-Jet toolholder with high pressure coolant nozzle	G055
JSDJ2XR/L□□□□□07-CHP	TungTurn-Jet toolholder with high pressure coolant nozzle	G060
JSDJ2XR/L...	MiniForce-Turn external toolholder	C045, G059
JSDJCR/L...	J-Series external toolholder	G056
JSDJCR□□□□□□-F15	J-Series stepped head toolholder	G057
JSDJXR/L...	MiniForce-Turn external toolholder	C045
JSDJXR□□□□□07-F15	MiniForce-Turn stepped head toolholder	G061
JSDN3CR...	J-Series external toolholder	G070
JSDNCN...	J-Series external toolholder	G070
JSE2R□□□□□16-CHP	TungTurn-Jet threading toolholder with high pressure coolant capability	E038, G162
JSEGR/L...	J-Series external toolholder	G089
JSTACR/L...	J-Series external toolholder	G074
JSTBR/L...	J-Series external toolholder	G083
JSTGR/L...	J-Series external grooving toolholder	F111, G133
JSTTR/L□□□□□3	External toolholder for Swiss lathes	E048, G165
JSVABR/L...	J-Series external toolholder	G076
JSVGR/L□□□□K-C	J-Series external grooving toolholder	F107, G137
JSVGR/L1616K	J-Series external grooving toolholder	F107, G137
JSVJ2BR/L□□□□□□-CHP	TungTurn-Jet external toolholder for high pressure coolant	G063
JSVJ2BR/L...	J-Series external toolholder for high pressure coolant	G062
JSVJ2XR/L□□□□□09-CHP	TungTurn-Jet external toolholder for high pressure coolant	G067
JSVJ2XR/L...	MiniForce-Turn external toolholder	C047, G065
JSVJBR/L...	J-Series external toolholder	G064
JSVJBR□□□□□11-F15	J-Series stepped head toolholder	G064
JSVJXR/L...	MiniForce-Turn external toolholder	C047
JSVJXR□□□□□09-F15	MiniForce-Turn stepped head toolholder	G067
JSVL2PR/L...	J-Series external toolholder	G044
JSVNBN...	J-Series external toolholder	G071
JSVP2PR/L...	J-Series external toolholder	G073
JSWL2XR/L1212F04-CHP	TungTurn-Jet external toolholder for high pressure coolant	G048
JSWL2XR/L...	MiniForce-Turn external toolholder	C029, G046
JSWL2XR□□□□X04-CHP	TungTurn-Jet external toolholder for high pressure coolant	G048
JSWLXR/L...	MiniForce-Turn external toolholder	C029
JSWLXR□□□□□04-F15	MiniForce-Turn stepped-head toolholder	G049
JSXBR/L□□□□K8	J-Series external toolholder	G164, E049
JSXBR/L□□□□K8-C	J-Series external toolholder	G164, E049
JSXGR/L□□□□K8	J-Series toolholder for front/back turning, external grooving	F108, G088, G136
JSXGR/L□□□□K8-C	J-Series toolholder for front/back turning, external grooving	F108, G088, G136
JSXXR/L□□□□□05	DuoForceCut parting toolholder	G086, G167
JSXXR/L□□□□□09	DuoJust-Cut parting toolholder	E047, F071, F247, G158, G169
JSXXR/L□□□□□09-CHP	DuoJust-Cut parting toolholder for high pressure coolant	E047, F071, F247, G159, G170
JSXXR/L□□□□□09-S	DuoJust-Cut parting toolholder for subspindle	F072, F248, G158, G169
JSXXR/L□□□□□09-S-CHP	DuoJust-Cut parting toolholder for high pressure coolant for subspindle	F072, F248, G159, G170

Designation	Product name	Page
JSXXR/L□□□□□09B-S-CHP	DuoJust-Cut parting toolholder for high pressure coolant for subspindle	F072, F248, G159, G170
JSXXR/L1616X09B-CHP	TungTurn-Jet parting toolholder with high pressure coolant capability	E047, G159
JTBR/L...	JTB insert (edge preparation)	B161, G085
JTBR/L□□□□F	JTB insert (shrap edge)	B161, G084
JTCL2CR/L...	J-Series toolholder	G042
JTDJ2CR/L...	J-Series toolholder	G054
JTGR/L...	J-Series grooving insert (honed edge)	F113
JTGR/L...	J-Series JTG grooving insert	G135
JTGR/L□□□□F...	J-Series grooving insert (sharp edge)	F112, F113, G134
JTTACR/L...	J-Series toolholder	G075
JTTANR/L...	J-Series toolholder	G077
JTTER/L...-S	TungCut Grooving & Parting toolholder for sub-spindle	G177
JTTER/L□□□□□1.2D□□-S	TungCut external grooving and parting toolholder for sub spindle	F020, F234, G177
JTTER/L□□□□□1.2D...	TungCut external grooving and parting toolholder	F019, F233, G177
JTTER/L...	TungCut Grooving & Parting toolholder	G177
JTTLNR/L...	J-Series toolholder	G051
JTTR/L30□□F	Threading insert, 60° thread angle (sharp edge)	E013, G166
JTTR/L3005F-55	Threading insert, 55° thread angle (sharp edge)	E016, G166
JVFN45R/L...	JVFN45R/L insert	G086
JVGR/L□□□□F	J-Series external grooving insert with hand	F107, G137
JVNR/L...	JVNR/L Blank insert	G087
JVPN□□R/L...	DuoForceCut parting insert	G167
JXBR/L...	JXB insert (edge preparation)	B160, G093
JXBR/L□□□□F	JXB insert (shrap edge)	B160, G092
JXDX□□R□□F	DuoJust-Cut insert	F074, G173
JXFR□□□□F	Positive insert for front turning	B159, G088
JXGR/L□□□□FA...	J-Series grooving insert	F108, G136
JXGR/L8200FN...	J-Series grooving insert	F108, G136
JXPG□□R/L□□□F...	DuoJust-Cut insert	F075, F250, G174
JXPS□□R/L□□□F	DuoJust-Cut insert	F074, F249, G173
JXRR□□□□F	Positive insert for reverse turning	B160, G088
JXT□R6000F	60° angle threading insert	E013, G164
JXTG12FR/L-□□□-...	DuoJust-Cut insert	G175
JXTG12FR/L-60□-...	DuoJust-Cut 60° angle threading insert	E012, G160, G175
K		
KNMX□□L/R-S1	Negative insert, parallelogram	B110
L		
L535B1EXT-FC	API Buttress threading insert	E032
L535B1INT-FC	API Buttress threading insert	E032
L535B75EXT-FC	API Buttress threading insert	E032
L535B75INT-FC	API Buttress threading insert	E032
LDS54□□□FT-CB #...	Threading insert	E035
LNMX□□□□□R/L-...	TurnTec insert	C055, C090, C103
LNMX□□□□□R/L-TDR	TurnTec Insert	D040
LNMX1606□□R/L-MDR	TurnTec Insert	D040
LNMX1606□□R/L-TWR	TurnTec Insert	D040
M		
MTVNR-□□□□M5	External threading toolholder	E051
MTVNR-3232M54	External threading toolholder	E051
MTVOR-□□□□M...	External threading toolholder	E052
P		
PCBNR/L2525	P-type external toolholder	C100
PCFNR/L...	P-type external toolholder	C087
PCL2NR2020H12	P-type external toolholder	G050
PCLCR/L1616X09S-CHP-MC	TungTurn-Jet external toolholder for high pressure coolant	C031
PCLNR/L□□□□□0904-CHP	TungTurn-Jet external toolholder for high pressure coolant	C019
PCLNR/L□□□□□0904-CHP-N	TungTurn-Jet external toolholder for high pressure coolant	C020
PCLNR/L□□□□□12-CHP	TungTurn-Jet external toolholder for high pressure coolant	C019
PCLNR/L□□□□X□□-CHP-MC	TungTurn-Jet external toolholder for high pressure coolant	C020
PCLNR/L...	P-type external toolholder	C018
PCL2NR2020H12	ISO-EcoTurn / P-type external toolholder	G050
PDJNR/L□□□□□1104-CHP	TungTurn-Jet external toolholder for high pressure coolant	C037
PDJNR/L□□□□□15-CHP	TungTurn-Jet external toolholder for high pressure coolant	C037
PDJNR/L...	ISO-EcoTurn / P-type external toolholder	C036, G068

Designation	Product name	Page
PDPNN...	P-type external toolholder	C108
PDQNR/L2525	P-type external toolholder	C093
POMG□□□□□□-MNW	TurnTenFeed insert	C067
PPXOR/L...	TurnTenFeed external toolholder	C067
PRDCN...	P-type external toolholder	C076
PRGCR/L...	P-type external toolholder	C062
PRGNR/L...	P-type external toolholder	C060
PSBNR/L...	P-type external toolholder	C102
PSDNN...	P-type external toolholder	C075
PSGB...	TungHeavyGroove wide grooving insert	F097, G139
PSGM...	TungHeavyGroove wide profile grooving insert	F097
PSKNR/L...	P-type external toolholder	C085
PSSNR/L...	P-type external toolholder	C081
PTFNR/L...	ISO-EcoTurn / P-type external toolholder	C089
PTGNR/L□□□□□□1104-CHP	TungTurn-Jet external toolholder for high pressure coolant	C059
PTGNR/L□□□□□□16-CHP	TungTurn-Jet external toolholder for high pressure coolant	C059
PTGNR/L...	ISO-EcoTurn / P-type external toolholder	C058
PTJNR/L...	ISO-EcoTurn external toolholder	C032
PTL2NR/L...	J-Series external toolholder	C030, G051
PVJNR/L□□□□□□1204-CHP	TungTurn-Jet external toolholder for high pressure coolant	C043
PVJNR/L□□□□□□16-CHP	TungTurn-Jet external toolholder for high pressure coolant	C043
PVJNR/L...	ISO-EcoTurn / P-type external toolholder	C042
PVQNR/L□□□□□□16-CHP	TungTurn-Jet external toolholder for high pressure coolant	C095
PVQNR/L...	ISO-EcoTurn external toolholder	C094
PVVNN...	ISO-EcoTurn external toolholder	C050
PWLNR/L□□□□□□0604-CHP	TungTurn-Jet external toolholder for high pressure coolant	C026
PWLNR/L□□□□□□08-CHP	TungTurn-Jet external toolholder for high pressure coolant	C026
PWLNR/L□□□□□□X□□-CHP-MC	TungTurn-Jet external toolholder for high pressure coolant	C027
PWLNR/L...	ISO-EcoTurn external toolholder	C026
Q		
QC-1212...	Shank for modular heads	E046, G095
QC-1212□-CHP	Shank for modular heads, with high pressure coolant capability	E046, G095
QC-1216□-F15-CHP	ModuMini-Turn Shank	G095
QC-12D28EXC	ModuMini-Turn Holder for insert exchange	G096
QC12-JSCL2CR09	ModuMini-Turn Head	G040
QC12-JSCL2CR09-CHP	ModuMini-Turn Head	G041
QC12-JSCL2CR09-Y	ModuMini-Turn Head	G040
QC12-JSCL2CR09-Y-CHP	ModuMini-Turn Head	G040
QC12-JSDJ2CR□□-CHP	ModuMini-Turn Head	G053
QC12-JSDJ2CR...	ModuMini-Turn Head	G053
QC12-JSDJ2CR11-Y	ModuMini-Turn Head	G052
QC12-JSDJ2CR11-Y-CHP	ModuMini-Turn Head	G052
QC12-JSDJ2XR07	ModuMini-Turn Head	G058
QC12-JSDJ2XR07-CHP	ModuMini-Turn Head	G059
QC12-JSDJ2XR07-Y	ModuMini-Turn Head	G058
QC12-JSDJ2XR07-Y-CHP	ModuMini-Turn Head	G058
QC12-JSDNXR07-CHP	ModuMini-Turn Head	G072
QC12-JSEGR10	ModuMini-Turn Head	G089
QC12-JSEGR10-CHP	ModuMini-Turn Head	G089
QC12-JSVJ2BR11	ModuMini-Turn Head	G062
QC12-JSVJ2BR11-CHP	ModuMini-Turn Head	G062
QC12-JSVJ2XR09	ModuMini-Turn Head	G065
QC12-JSVJ2XR09-CHP	ModuMini-Turn Head	G066
QC12-JSVVXR09-CHP	ModuMini-Turn Head	G083
QC12-JSWL2XR04	ModuMini-Turn Head	G046
QC12-JSWL2XR04-CHP	ModuMini-Turn Head	G046
QC12-JSWL2XR04-Y	ModuMini-Turn Head	G045
QC12-JSWL2XR04-Y-CHP	ModuMini-Turn Head	G045
QC12-JTTER/L□□□□□□-CHP	TungCut Grooving & Parting head with high pressure coolant	G178
QC12-STCR/L18	TetraMini-Cut external grooving and threading head	E044, G114, G153
QC12-STCR/L18-CHP	TetraMini-Cut external grooving and threading head with high pressure coolant capability	E044, G114, G153
QC12-STCR/L18-Y	Y-axis turning modular head for external grooving and threading	E045, G113, G152
QC12-STCR/L18-Y-CHP	Y-axis turning modular head for external grooving and threading, with high pressure coolant capability	E045, G113, G152
QC12-STOPPER	ModuMini-Turn Plug	G096
QC12-SVER/L10-CHP	ModuMini-Turn Head	G110, G150
Q-CCMW060204	CBN insert, 80° rhombic, positive	B190
Q-CCMW09T304	CBN insert, 80° rhombic, positive	B191
Q-DCMW070204	CBN insert, 55° rhombic, positive	B193
Q-DCMW11T304	CBN insert, 55° rhombic, positive	B194
QGM□-...	AddForceCut grooving insert	F013, F124, F227, G193

Designation	Product name	Page
QGS□-...	AddForceCut grooving insert	F013, F125, F228, G193
QSER/L□□□□□□-□T...	AddForceCut external grooving and parting toolholder	F012, F224
QSER/L2020-...	AddForceCut Grooving & Parting toolholder	G191
QSG□□□-□D	AddForceCut Grooving & Parting blade	G192
QSG□□□-□T	AddForceCut parting-off and external grooving blade	F226, G192
QSP□□□-□D	AddForceCut external deep grooving and parting blade	F224, G191
Q-SPGN0903...	CBN insert, square, positive	B196
Q-TPGN1103...	CBN insert, triangular, positive	B202
Q-TPGN1603...	CBN insert, triangular, positive	B203
Q-TPGW16T304	CBN insert, triangular, positive	B201
Q-TPMW080204	CBN insert, triangular, positive	B198
Q-TPMW0902...	CBN insert, triangular, positive	B199
Q-TPMW1102...	CBN insert, triangular, positive	B199
Q-TPMW1103...	CBN insert	B200
Q-TPMW1303...	CBN insert, triangular, positive	B201
Q-TPMW1604...	CBN insert, triangular, positive	B202
R		
RCGT□□□□M0-AL	Round, positive, ISO insert	B130
RCGX...	Round, positive, ISO insert	B132
RCGX□□□□□□-E/T1	Round, positive, ISO insert	C079
RCMM□□□□M0-61	Round, positive, ISO insert	B131
RCMT□□□□M0-61	Round, positive, ISO insert	B131
RCMT□□□□M0-CM	Round, positive, ISO insert	B130
RCMT□□□□M0-RS	Round, positive, ISO insert	B130
RCMT1204M0-6R...	FixR-Turn insert	C064, C078
RCMT1204M0-6RM	Round, positive, ISO insert	B130, C064
RCMT1204M0-6RS	Round, positive, ISO insert	B130, C064
RNGA120400	Round, negative, ISO insert	B076
RNGN120...	Round, negative, ISO insert	B076
RNGN120700-E/T1	Round, negative, ISO insert	B076, C061
RNMG□□□-61	Round, negative, ISO insert	B076
RSL-□□□-□□-L...	BoreMeister split sleeve for anti-vibration bar	E058, D092
RT...	Special round, positive insert	B131
S		
S□□□-CGTR/L...	My-T Series internal grooving toolholder	F146
S□□□-CSKPR/L...	Boring bar, steel shank	D042
S□□□-CTFPR/L...	Boring bar, steel shank	D047
S□□□-PCLNR/L...	Boring bar, steel shank	D027
S□□□-PDUNR/L...	Boring bar, steel shank	D070
S□□□-PDZNR/L15	Boring bar, steel shank	D089
S□□□-PSKNR12-...	Boring bar, steel shank	D043
S□□□-PTFNR/L16	Boring bar, steel shank	D049
S□□□-PTUNR/L...	Boring bar, steel shank	D067
S□□□-PWLNR/L06	Boring bar, steel shank	D032
S□□□-TLANR/L□□-...	TurnTec boring bar, steel shank	D040
S□□-DDUNR/L□□T-H	BoreMeister exchangeable boring head	D073
S□□-PCLNR/L□□-H	BoreMeister exchangeable boring head	D029
S□□-PTFNR/L□□-H	BoreMeister exchangeable boring head	D050
S□□-QSR/L□□□□□□-H	AddForceCut internal grooving head	F122
S□□R-SGTR/L...	Internal grooving toolholder	F156
S□□-SCLCR/L□□-H	BoreMeister exchangeable boring head	D017
S□□-SCLXR/L□□-H	BoreMeister exchangeable boring head	D022
S□□-SDUCR/L□□-H	BoreMeister exchangeable boring head	D057
S□□-SDUCR/L□□T-H	BoreMeister exchangeable boring head	D057
S□□-SNR16-H	BoreMeister internal threading head	E056
S□□-STFPR/L□□-H	BoreMeister exchangeable boring head	D048
S□□-SVLCR/L16T-H	BoreMeister exchangeable boring head	D020
S□□-SVUCR/L11-H	BoreMeister exchangeable boring head	D063
S□□-SWLXR/L□□-H	BoreMeister exchangeable boring head	D024
S□□-SXUOR05-H	BoreMeister exchangeable boring head	D066
S40-DVUNR/L16T-H	BoreMeister boring head	D075
S-570-□□M-...	Shank for internal grooving and threading head	F152
SCLCR/L...	S-type external toolholder	C030
SCMT□□□-23	Square, positive, ISO insert	B134
SCMT□□□-24	Square, positive, ISO insert	B134
SCMT□□□-CM	Square, positive, ISO insert	B134
SCMT□□□-PM	Square, positive, ISO insert	B134
SCMT□□□-PS	Square, positive, ISO insert	B134
S-CNGN0903...	CBN insert, 80° rhombic, negative, solid type	B170
S-CNGN1204...	CBN insert, 80° rhombic, negative, solid type	B171
SDJCR...	S-type external toolholder	C046
SDNCN...	S-type external toolholder	C073
SDQCR/L...	S-type external toolholder	C096
SER□□□□H11	External threading toolholder	E040, G164

Designation	Product name	Page
T□□□-PDUNR15C	Tsuppari-Ichiban internal toolholder	D071
T□□□-PTUNR...	Tsuppari-Ichiban internal toolholder	D068
T□□□-SCLCR/L...	Tsuppari-Ichiban internal toolholder	D016
T□□□-SCLPR/L...	Tsuppari-Ichiban internal toolholder	D019
T□□□-SDQCR/L11C	Tsuppari-Ichiban internal toolholder	D077
T□□□-STUPR/L...	Tsuppari-Ichiban internal toolholder	D055
T16Q-SDQCR/L07	Tsuppari-Ichiban internal toolholder	D077
T20R-SVQBR11C	Tsuppari-Ichiban internal toolholder	D080
T20R-SVUBR11C	Tsuppari-Ichiban internal toolholder	D060
T25S-SVQCR16C	Tsuppari-Ichiban internal toolholder	D082
T25S-SVUCR16C	Tsuppari-Ichiban internal toolholder	D062
T2QP-CNGA1204...	CBN insert, 80° rhombic, negative	B168, B169
T3QP-TNGA1604...	CBN insert, triangular, negative	B182, B183
TBBR...	TinyMini-Turn solid carbide bar	G101
TBCR...	TinyMini-Turn solid carbide bar	G100
TBFR...	TinyMini-Turn solid carbide bar	G104
TBGN0601□□-15-QBN	CBN insert, triangular, positive	B197
TBGR...	TinyMini-Turn solid carbide bar	G102
TBIR...	TinyMini-Turn solid carbide bar	E059, G101
TBM□□R/LF□□-2.25	TungBoreMini toolholder	D065
TBPR...	TinyMini-Turn solid carbide bar	G099
TBRR...	TinyMini-Turn solid carbide bar	G105
TBSR07200200-D060	TinyMini-Turn solid carbide bar	G105
TBTR/L...	TinyMini-Turn solid carbide bar	G097
TBUR...	TinyMini-Turn solid carbide bar	G099
TCF18L...	TetraMini-Cut face grooving insert	F205, G149
TCG18R/L...	TetraMini-Cut insert (edge preparation)	F054, F055, F208, F209, G120
TCG18R/L...	TetraMini-Cut insert (Full R)	F055, F209, G121
TCGT□□-01	Traingular, positive, ISO insert	B138
TCGT□□-AL	Traingular, positive, ISO insert	B140
TCGT□□F-01	Traingular, positive, ISO insert	B138
TCGT□□FN-JP	Traingular, positive, ISO insert	B138
TCGT□□FN-JS	Traingular, positive, ISO insert	B138
TCGT□□FR/L-J08	Traingular, positive, ISO insert	B139
TCGT□□FR/L-J10	Traingular, positive, ISO insert	B139
TCGT□□L-W15	Traingular, positive, ISO insert	B139
TCGT□□N-JS	Traingular, positive, ISO insert	B138
TCGT□□R/L-J10	Traingular, positive, ISO insert	B139
TCGT□□-SS	Traingular, positive, ISO insert	B141
TCGT080102R	Traingular, positive, ISO insert	B141
TCIG□□-...	AddInternalCut internal grooving insert	F121
TCIG...	AddInternalCut internal grooving insert	G141
TCL18R/L...	TetraMini-Cut grooving insert	F053, F207, G118
TCL27-□□□-...	TetraForce-Cut Grooving insert	F065, G127
TCL38-□□□-...	TetraForce-Cut Grooving insert	F069, G132
TCLNR/L...	External toolholder	C023
TCM27-□□□-...	TetraForce-Cut grooving insert	F068, G130
TCM27-□□□-...	TetraForce-Cut Grooving insert (Full R)	F069, G131
TCMT□□-23	Traingular, positive, ISO insert	B141
TCMT□□-24	Traingular, positive, ISO insert	B141
TCMT□□-CM	Traingular, positive, ISO insert	B140
TCMT□□-PM	Traingular, positive, ISO insert	B141
TCMT□□-PS	Traingular, positive, ISO insert	B140
TCMT□□-PSF	Traingular, positive, ISO insert	B138
TCMT□□-PSS	Traingular, positive, ISO insert	B140
TCMT□□-TM	Traingular, positive, ISO insert	B140
TCMT□□-TSF	Traingular, positive, ISO insert	B138
TCMT0802□□-DIA	PCD insert, triangular, positive	B215
TCMT1102□□-DIA	PCD insert, triangular, positive	B216
TCMT1103□□-DIA	PCD insert, triangular, positive	B216
TCNR□□□□□□DT	Internal grooving and threading toolholder	E056, F154
TCP18R/L...	TetraMini-Cut grooving insert	F056, F210, G122
TCP18R/L□□□F...	TetraMini-Cut Grooving insert (Sharp Edge)	F057, F211, G123
TCS18R/L...	TetraMini-Cut grooving insert	F052, F053, F205, F206, G118
TCS27-□□□-...	TetraForce-Cut Grooving insert	F066, F067, G128
TCS27-□□□-...	TetraForce-Cut Grooving insert (Full R)	G129
TCS27-□□□-□□R/L	TetraForce-Cut Grooving insert	F067, G129
TCT18FR-□□□ISO	TetraMini-Cut ISO metric threading insert	E020, G156

Designation	Product name	Page
TCT18FR-□□ISO	TetraMini-Cut ISO metric threading insert	E020, G156
TCT18FR-60A-...	TetraMini-Cut 60° angle threading insert	E012, G157
TCT18R/L-60N-...	TetraMini-Cut 60° angle threading insert	E012, G156
TCT18R-□□ISO	TetraMini-Cut ISO metric threading insert	E020, G156
TCT18R-125ISO	TetraMini-Cut ISO metric threading insert	E020, G156
TGTSR/L□□□□□16	External grooving toolholder	F099
TGTSR/L□□□□□22-...	External grooving toolholder	F099
TGTTR/L□□□□□16	Perpendicular toolholder for external grooving	F099
TGTTR/L□□□□□22-...	Perpendicular toolholder for external grooving	F099
TLANR/L...	TurnTec external toolholder	C054
TLBNR/L4040R24	TurnTec external toolholder	C103
TLFNR/L...	TurnTec external toolholder	C090
TNGA...	Traingular, negative, ISO insert	B096
TNGA1604□□-DIA	PCD insert, triangular, negative	B212
TNGA1604□□-QBN	CBN insert, triangular, negative	B185
TNGG□□-01	Traingular, negative, ISO insert	B089
TNGG□□F-01	Traingular, negative, ISO insert	B089
TNGG□□FR/L-P	Traingular, negative, ISO insert	B094
TNGG□□FR/L-W	Traingular, negative, ISO insert	B090
TNGG□□R/L-A	Traingular, negative, ISO insert	B090
TNGG□□R/L-C	Traingular, negative, ISO insert	B090
TNGG□□R/L-D	Traingular, negative, ISO insert	B090
TNGG□□R/L-P	Traingular, negative, ISO insert	B094
TNGG□□R/L-W	Traingular, negative, ISO insert	B090
TNGN...	Traingular, negative, ISO insert	B097
TNMA...	Traingular, negative, ISO insert	B096
TNMA4310RDEXT	API Round threading insert	E031
TNMA4310RDINT	API Round threading insert	E031
TNMA438RDEXT	API Round threading insert	E031
TNMA438RDINT	API Round threading insert	E031
TNMA43NT□□PEXT-PT	29° Trapezoidal threading insert	E029
TNMA43NT□□PSTUBE-PT	29° Trapezoidal threading insert	E030
TNMA43NT□□PEXT-PT	29° Trapezoidal threading insert	E029
TNMA43NT□□PSTUBE-PT	29° Trapezoidal threading insert	E030
TNMA545B1EXT-FC	API Buttress threading insert	E033
TNMA545B1INT-FC	API Buttress threading insert	E033
TNMA545B7EXT-FC	API Buttress threading insert	E033
TNMA545B75INT-FC	API Buttress threading insert	E033
TNMA54NT□□PEXT-PT	29° Trapezoidal threading insert	E029
TNMA54NT□□PSTUBE-PT	29° Trapezoidal threading insert	E030
TNMC4310RDEXT	API Round threading insert	E031
TNMC4310RDINT	API Round threading insert	E031
TNMC438RDEXT	API Round threading insert	E031
TNMC438RDINT	API Round threading insert	E031
TNMC43NT□□PEXT-PT	29° Trapezoidal threading insert	E029
TNMC43NT□□PSTUBE-PT	29° Trapezoidal threading insert	E030
TNMC43NT□□PEXT-PT	29° Trapezoidal threading insert	E029
TNMC43NT□□PSTUBE-PT	29° Trapezoidal threading insert	E030
TNMC545B1EXT-FC	API Buttress threading insert	E033
TNMC545B1INT-FC	API Buttress threading insert	E033
TNMC545B7EXT-FC	API Buttress threading insert	E033
TNMC545B75INT-FC	API Buttress threading insert	E033
TNMC54NT□□PEXT-PT	29° Trapezoidal threading insert	E029
TNMC54NT□□PSTUBE-PT	29° Trapezoidal threading insert	E030
TNMG...	Traingular, negative, ISO insert	B092
TNMG□□-11	Traingular, negative, ISO insert	B089
TNMG□□-17	Traingular, negative, ISO insert	B089
TNMG□□-27	Traingular, negative, ISO insert	B094
TNMG□□-28	Traingular, negative, ISO insert	B094
TNMG□□-33	Traingular, negative, ISO insert	B094
TNMG□□-37	Traingular, negative, ISO insert	B094
TNMG□□-38	Traingular, negative, ISO insert	B095
TNMG□□-AM	Traingular, negative, ISO insert	B091
TNMG□□-AS	Traingular, negative, ISO insert	B087
TNMG□□-CB	Traingular, negative, ISO insert	B089
TNMG□□-CF	Traingular, negative, ISO insert	B088
TNMG□□-CH	Traingular, negative, ISO insert	B095
TNMG□□-CM	Traingular, negative, ISO insert	B092
TNMG□□-DM	Traingular, negative, ISO insert	B092
TNMG□□E-FW	Traingular, negative, ISO insert	B088
TNMG□□E-SM	Traingular, negative, ISO insert	B092
TNMG□□E-SS	Traingular, negative, ISO insert	B088
TNMG□□E-SW	Traingular, negative, ISO insert	B093
TNMG□□E-TM	Traingular, negative, ISO insert	B090
TNMG□□E-TSF	Traingular, negative, ISO insert	B087
TNMG□□-FW	Traingular, negative, ISO insert	B088
TNMG□□-HMM	Traingular, negative, ISO insert	B093

Alphanumeric Index

Designation	Product name	Page
TNMG□□-HRF	Traingular, negative, ISO insert	B088
TNMG□□-HRM	Traingular, negative, ISO insert	B092
TNMG□□-NM	Traingular, negative, ISO insert	B091
TNMG□□-NS	Traingular, negative, ISO insert	B087
TNMG□□-PM	Traingular, negative, ISO insert	B091
TNMG□□-PS	Traingular, negative, ISO insert	B087
TNMG□□R/L-S	Traingular, negative, ISO insert	B094
TNMG□□-SA	Traingular, negative, ISO insert	B093
TNMG□□-SDM	Traingular, negative, ISO insert	B092
TNMG□□-SF	Traingular, negative, ISO insert	B088
TNMG□□-SM	Traingular, negative, ISO insert	B092
TNMG□□-SS	Traingular, negative, ISO insert	B088
TNMG□□-SW	Traingular, negative, ISO insert	B093
TNMG□□-TA	Traingular, negative, ISO insert	B093
TNMG□□-TF	Traingular, negative, ISO insert	B087
TNMG□□-TH	Traingular, negative, ISO insert	B095
TNMG□□-THS	Traingular, negative, ISO insert	B095
TNMG□□-TM	Traingular, negative, ISO insert	B090
TNMG□□-TQ	Traingular, negative, ISO insert	B093
TNMG□□-TS	Traingular, negative, ISO insert	B088
TNMG□□-TSF	Traingular, negative, ISO insert	B087
TNMG□□-ZF	Traingular, negative, ISO insert	B087
TNMG□□-ZM	Traingular, negative, ISO insert	B091
TNMM□□-57	Traingular, negative, ISO insert	B095
TNMG□□E-TF	Traingular, negative, ISO insert	B087
TNMM1604□□-DIA	PCD insert, traingular, negative	B212
TPGA...	Traingular, positive, ISO insert	B147
TPGA0902□□-DIA	PCD insert, traingular, positive	B216
TPGA0902□□-QBN	CBN insert, traingular, positive	B205
TPGA1102□□-DIA	PCD insert, traingular, positive	B217
TPGA1102□□-QBN	CBN insert, traingular, positive	B205
TPGA1103□□-DIA	PCD insert, traingular, positive	B217
TPGA1103□□-QBN	CBN insert, traingular, positive	B206
TPGA1603□□-DIA	PCD insert, traingular, positive	B217
TPGA1603□□-QBN	CBN insert, traingular, positive	B206
TPGH□□L-H11	Traingular, positive, ISO insert	B146
TPGH□□L-W10	Traingular, positive, ISO insert	B143
TPGH□□L-W13	Traingular, positive, ISO insert	B144
TPGM□□L-2	Traingular, positive, ISO insert	B146
TPGM□□R/L	Traingular, positive, ISO insert	B146
TPGN...	Traingular, positive, ISO insert	B149
TPGN090204-DIA	PCD insert, traingular, positive	B218
TPGN1103□□-DIA	PCD insert, traingular, positive	B218
TPGN1103□□-QBN	CBN insert, traingular, positive	B204
TPGN1603□□-DIA	PCD insert, traingular, positive	B218
TPGN1603□□-QBN	CBN insert, traingular, positive	B205
TPGR□□R/L	Traingular, positive, ISO insert	B148
TPGT□□-01	Traingular, positive, ISO insert	B142
TPGT□□F-JS	Traingular, positive, ISO insert	B142
TPGT□□FR/L-W08	Traingular, positive, ISO insert	B143
TPGT□□-JS	Traingular, positive, ISO insert	B142
TPGT□□R/L-W08	Traingular, positive, ISO insert	B143
TPGT□□R/L-W15	Traingular, positive, ISO insert	B144
TPGT□□-SS	Traingular, positive, ISO insert	B144
TPGW...	Traingular, positive, ISO insert	B147
TPGW0802□□-DIA	PCD insert, traingular, positive	B219
TPGW0902□□-DIA	PCD insert, traingular, positive	B219
TPGW0902□□-QBN	CBN insert, traingular, positive	B203
TPGW1102□□-DIA	PCD insert, traingular, positive	B219
TPGW1102□□-QBN	CBN insert, traingular, positive	B203
TPGW1303□□-DIA	PCD insert, traingular, positive	B220
TPGW1303□□-QBN	CBN insert, traingular, positive	B204
TPGW16T3□□-DIA	PCD insert, traingular, positive	B220
TPGW16T3□□-QBN	CBN insert, traingular, positive	B204
TPMN...	Traingular, positive, ISO insert	B148
TPMR□□-23	Traingular, positive, ISO insert	B148
TPMR□□-24	Traingular, positive, ISO insert	B149
TPMR□□-CM	Traingular, positive, ISO insert	B148
TPMR□□-PS	Traingular, positive, ISO insert	B148
TPMT□□-23	Traingular, positive, ISO insert	B146
TPMT□□-24	Traingular, positive, ISO insert	B147
TPMT□□-CM	Traingular, positive, ISO insert	B146
TPMT□□-PF	Traingular, positive, ISO insert	B142
TPMT□□-PM	Traingular, positive, ISO insert	B147
TPMT□□-PS	Traingular, positive, ISO insert	B145
TPMT□□-PSF	Traingular, positive, ISO insert	B142
TPMT□□-PSS	Traingular, positive, ISO insert	B145

Designation	Product name	Page
TPMT□□TM	Traingular, positive, ISO insert	B145
TPMT□□-TSF	Traingular, positive, ISO insert	B143
TPMW...	Traingular, positive, ISO insert	B147
TRDCN...	External toolholder	C079
TRGNR/L2525M1207-F	External toolholder	C061
TSKNR/L2525M1207-F	External toolholder	C086
TSNR...	Internal threading toolholder	E055
TT-2525R/LE	External threading toolholder	E053
TT-2525RI	Internal threading toolholder	E066
TTR/L42M-005	60° angle threading insert	E014
TTR/L42W-005	55° angle threading insert	E016

V		
VBGT□□FN-JP	35° rhombic, positive, ISO insert	B150
VBGT□□FN-JS	35° rhombic, positive, ISO insert	B150
VBGT□□N-JS	35° rhombic, positive, ISO insert	B150
VBGT□□FR/L-J10	35° rhombic, positive, ISO insert	B150
VBGT□□R/L-J10	35° rhombic, positive, ISO insert	B150
VBMT□□-24	35° rhombic, positive, ISO insert	B151
VBMT□□-CM	35° rhombic, positive, ISO insert	B151
VBMT□□-PF	35° rhombic, positive, ISO insert	B150
VBMT□□-PS	35° rhombic, positive, ISO insert	B151
VBMT□□-PSF	35° rhombic, positive, ISO insert	B150
VBMT□□-PSS	35° rhombic, positive, ISO insert	B151
VBMT□□-TM	35° rhombic, positive, ISO insert	B151
VBMT□□-TSF	35° rhombic, positive, ISO insert	B150
VCGT□□-AL	35° rhombic, positive, ISO insert	B153
VCGW1604□□-DIA	PCD insert, 35° rhombic, positive	B220
VCMT...	35° rhombic, positive, ISO insert	B153
VCMT□□-24	35° rhombic, positive, ISO insert	B153
VCMT□□-CM	35° rhombic, positive, ISO insert	B152
VCMT□□-PF	35° rhombic, positive, ISO insert	B152
VCMT□□-PS	35° rhombic, positive, ISO insert	B152
VCMT□□-PSF	35° rhombic, positive, ISO insert	B152
VCMT□□-PSS	35° rhombic, positive, ISO insert	B152
VCMT□□-TM	35° rhombic, positive, ISO insert	B152
VCMT□□-TSF	35° rhombic, positive, ISO insert	B152
VCMT1604□□-DIA	PCD insert, 35° rhombic, positive	B220
VGP...	MiniV-lockGroove Grooving insert	G111
VGT10F...	MiniV-lockGroove threading insert	G151
VNGA...	35° rhombic, negative, ISO insert	B101
VNGD...	35° rhombic, negative, ISO insert	B101
VNGG□□-01	35° rhombic, negative, ISO insert	B099
VNMA...	35° rhombic, negative, ISO insert	B101
VNMG...	35° rhombic, negative, ISO insert	B100
VNMG□□-11	35° rhombic, negative, ISO insert	B099
VNMG□□-28	35° rhombic, negative, ISO insert	B101
VNMG□□-33	35° rhombic, negative, ISO insert	B101
VNMG□□-CF	35° rhombic, negative, ISO insert	B099
VNMG□□-CM	35° rhombic, negative, ISO insert	B100
VNMG□□-DM	35° rhombic, negative, ISO insert	B100
VNMG□□E-TF	35° rhombic, negative, ISO insert	B098
VNMG□□E-TSF	35° rhombic, negative, ISO insert	B098
VNMG□□-HMM	35° rhombic, negative, ISO insert	B100
VNMG□□-HRF	35° rhombic, negative, ISO insert	B098
VNMG□□-HRM	35° rhombic, negative, ISO insert	B100
VNMG□□-PM	35° rhombic, negative, ISO insert	B099
VNMG□□-PS	35° rhombic, negative, ISO insert	B098
VNMG□□-SDM	35° rhombic, negative, ISO insert	B100
VNMG□□-SF	35° rhombic, negative, ISO insert	B098
VNMG□□-SM	35° rhombic, negative, ISO insert	B100
VNMG□□-SS	35° rhombic, negative, ISO insert	B098
VNMG□□-TF	35° rhombic, negative, ISO insert	B098
VNMG□□-TM	35° rhombic, negative, ISO insert	B099
VNMG□□-TQ	35° rhombic, negative, ISO insert	B100
VNMG□□-TS	35° rhombic, negative, ISO insert	B098
VNMG□□-TSF	35° rhombic, negative, ISO insert	B098
VNMG□□-ZF	35° rhombic, negative, ISO insert	B098
VNMG□□-ZM	35° rhombic, negative, ISO insert	B099
VNMM1604□□-DIA	PCD insert, 35° rhombic, negative	B212
VPET□□MFR/JSP	35° rhombic, positive, ISO insert	B154
VPET□□MFR/L-JPP	35° rhombic, positive, ISO insert	B154
VPET□□MFR/L-JRP	35° rhombic, positive, ISO insert	B154
VXGU□□MFR/LE-JRP	MiniForce-Turn insert, 35° rhombic, positive	B155
VXGU□□MFR/L-JS	MiniForce-Turn insert, 35° rhombic, positive	B155

Designation	Product name	Page
W		
WBGTRFR/L-JS	80° hexagonal, positive, ISO insert	B156
WBGTRFR/L-W08	80° hexagonal, positive, ISO insert	B156
WBGTRL-W11	80° hexagonal, positive, ISO insert	B156
WBGTRR/L-JS	80° hexagonal, positive, ISO insert	B156
WBGTRR/L-W08	80° hexagonal, positive, ISO insert	B156
WGE...	My-T Series Grooving insert	F083, F254
WGER/L	My-T Series Grooving insert	F083, F255
WGR...	My-T Series Grooving insert	F084
WGT...	My-T Series Grooving insert	F084, F254
WNGA...	80° hexagonal, negative, ISO insert	B109
WNGG-01	80° hexagonal, negative, ISO insert	B104
WNMA...	80° hexagonal, negative, ISO insert	B109
WNMAE	80° hexagonal, negative, ISO insert	B109
WNMG...	80° hexagonal, negative, ISO insert	B106
WNMG-11	80° hexagonal, negative, ISO insert	B104
WNMG-17	80° hexagonal, negative, ISO insert	B104
WNMG-27	80° hexagonal, negative, ISO insert	B108
WNMG-33	80° hexagonal, negative, ISO insert	B108
WNMG-37	80° hexagonal, negative, ISO insert	B108
WNMG-AFW	80° hexagonal, negative, ISO insert	B104
WNMG-AM	80° hexagonal, negative, ISO insert	B106
WNMG-AS	80° hexagonal, negative, ISO insert	B102
WNMG-ASW	80° hexagonal, negative, ISO insert	B107
WNMG-CB	80° hexagonal, negative, ISO insert	B104
WNMG-CF	80° hexagonal, negative, ISO insert	B104
WNMG-CH	80° hexagonal, negative, ISO insert	B109
WNMG-CM	80° hexagonal, negative, ISO insert	B107
WNMG-DM	80° hexagonal, negative, ISO insert	B106
WNMG-E-FW	80° hexagonal, negative, ISO insert	B104
WNMG-E-SM	80° hexagonal, negative, ISO insert	B106
WNMG-E-SS	80° hexagonal, negative, ISO insert	B103
WNMG-E-SW	80° hexagonal, negative, ISO insert	B107
WNMG-E-TF	80° hexagonal, negative, ISO insert	B102
WNMG-E-TM	80° hexagonal, negative, ISO insert	B103
WNMG-E-TS	80° hexagonal, negative, ISO insert	B103
WNMG-E-TSF	80° hexagonal, negative, ISO insert	B102
WNMG-E-ZF	80° hexagonal, negative, ISO insert	B102
WNMG-E-ZM	80° hexagonal, negative, ISO insert	B105
WNMG-FW	80° hexagonal, negative, ISO insert	B104
WNMG-HMM	80° hexagonal, negative, ISO insert	B108
WNMG-HRF	80° hexagonal, negative, ISO insert	B103
WNMG-HRM	80° hexagonal, negative, ISO insert	B106
WNMG-NM	80° hexagonal, negative, ISO insert	B106
WNMG-NS	80° hexagonal, negative, ISO insert	B102
WNMG-PM	80° hexagonal, negative, ISO insert	B105
WNMG-PS	80° hexagonal, negative, ISO insert	B102
WNMG-SA	80° hexagonal, negative, ISO insert	B108
WNMG-SDM	80° hexagonal, negative, ISO insert	B106
WNMG-SF	80° hexagonal, negative, ISO insert	B103
WNMG-SH	80° hexagonal, negative, ISO insert	B109
WNMG-SM	80° hexagonal, negative, ISO insert	B106
WNMG-SS	80° hexagonal, negative, ISO insert	B103
WNMG-SW	80° hexagonal, negative, ISO insert	B107
WNMG-TA	80° hexagonal, negative, ISO insert	B107
WNMG-TF	80° hexagonal, negative, ISO insert	B102
WNMG-TH	80° hexagonal, negative, ISO insert	B108
WNMG-THS	80° hexagonal, negative, ISO insert	B108
WNMG-TM	80° hexagonal, negative, ISO insert	B105
WNMG-TQ	80° hexagonal, negative, ISO insert	B107
WNMG-TS	80° hexagonal, negative, ISO insert	B103
WNMG-TSF	80° hexagonal, negative, ISO insert	B102
WNMG-ZF	80° hexagonal, negative, ISO insert	B102
WNMG-ZM	80° hexagonal, negative, ISO insert	B105
WPMT090725ZPR/L-ML	TurnFeed insert	B155, C068
WTJNR/L...	W-type external toolholder	C033
WXGU-MFR/L-JS	MiniForce-Turn insert, 80° trigon, positive, double-sided	B157
WXGU-MFR/L-JSS	MiniForce-Turn insert, 80° trigon, positive, double-sided	B157
WXGU-MFR/L-JTS	MiniForce-Turn insert, 80° trigon, positive, double-sided	B158
WXGU-MR/L-JSS	MiniForce-Turn insert, 80° trigon, positive, double-sided	B157
WXGU-MR/L-JTS	MiniForce-Turn insert, 80° trigon, positive, double-sided	B158
WXGURR/L-SS	MiniForce-Turn insert, 80° trigon, positive, double-sided	B157
WXGURR/L-TS	MiniForce-Turn insert, 80° trigon, positive, double-sided	B158
WXGURR/L-TSW	MiniForce-Turn insert, 80° trigon, positive, double-sided	B157
X		
XGR/L-02	Grooving insert	F105, F166

Designation	Product name	Page
XGR/L-S-QBN	CBN insert for grooving	F106
XNR/L-...	Face grooving insert	F222
XOMU-PS	TungBoreMini insert	D066
XWXPR/L-09	TurnFeed external toolholder	C068
Y		
YNMG-ZF	25° rhombic, negative insert	B110
YNMG-ZM	25° rhombic, negative insert	B110
YWMT-ZF	25° rhombic, positive insert	B159
YWMT-ZM	25° rhombic, positive insert	B159

MEMO

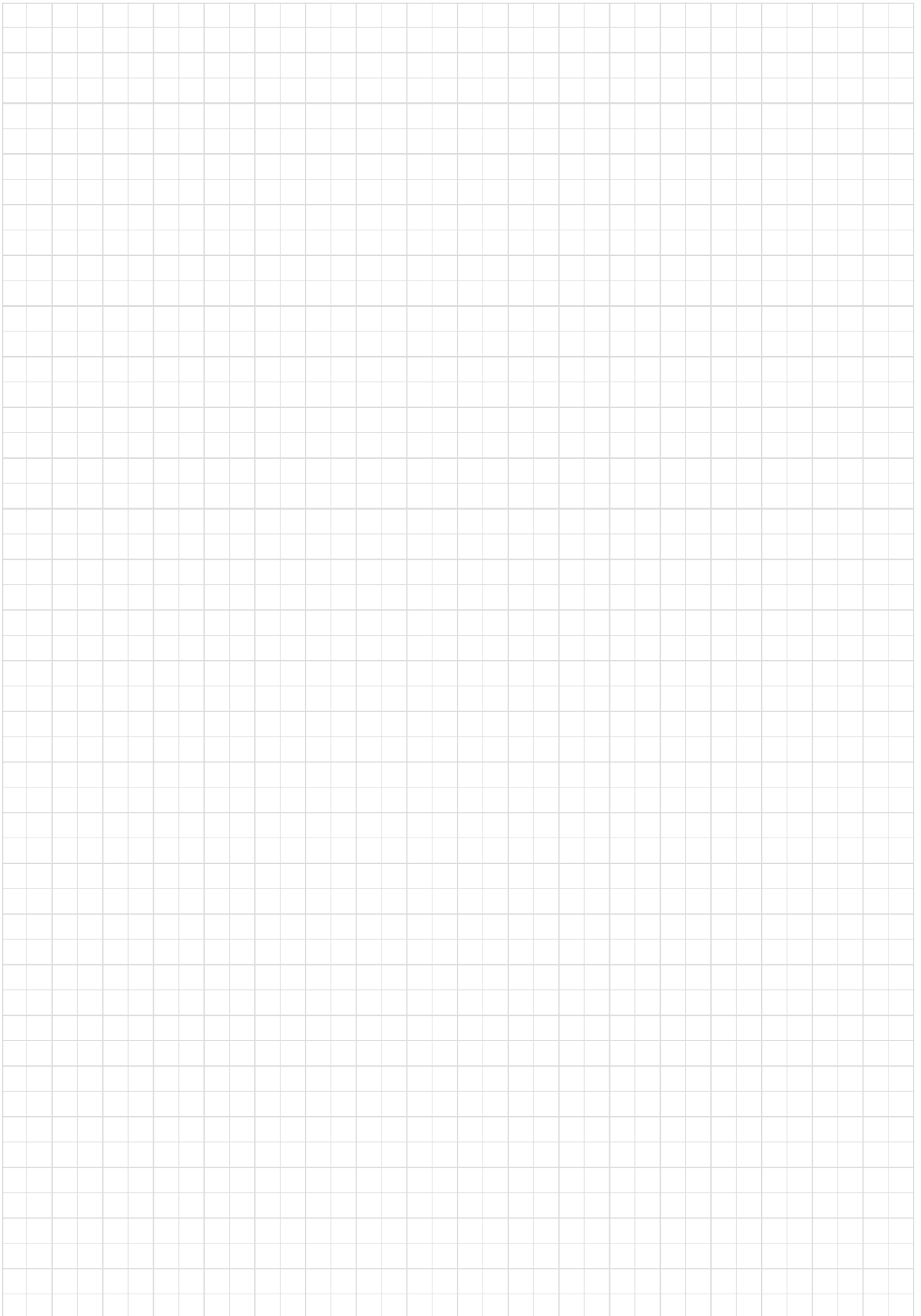

MEMO

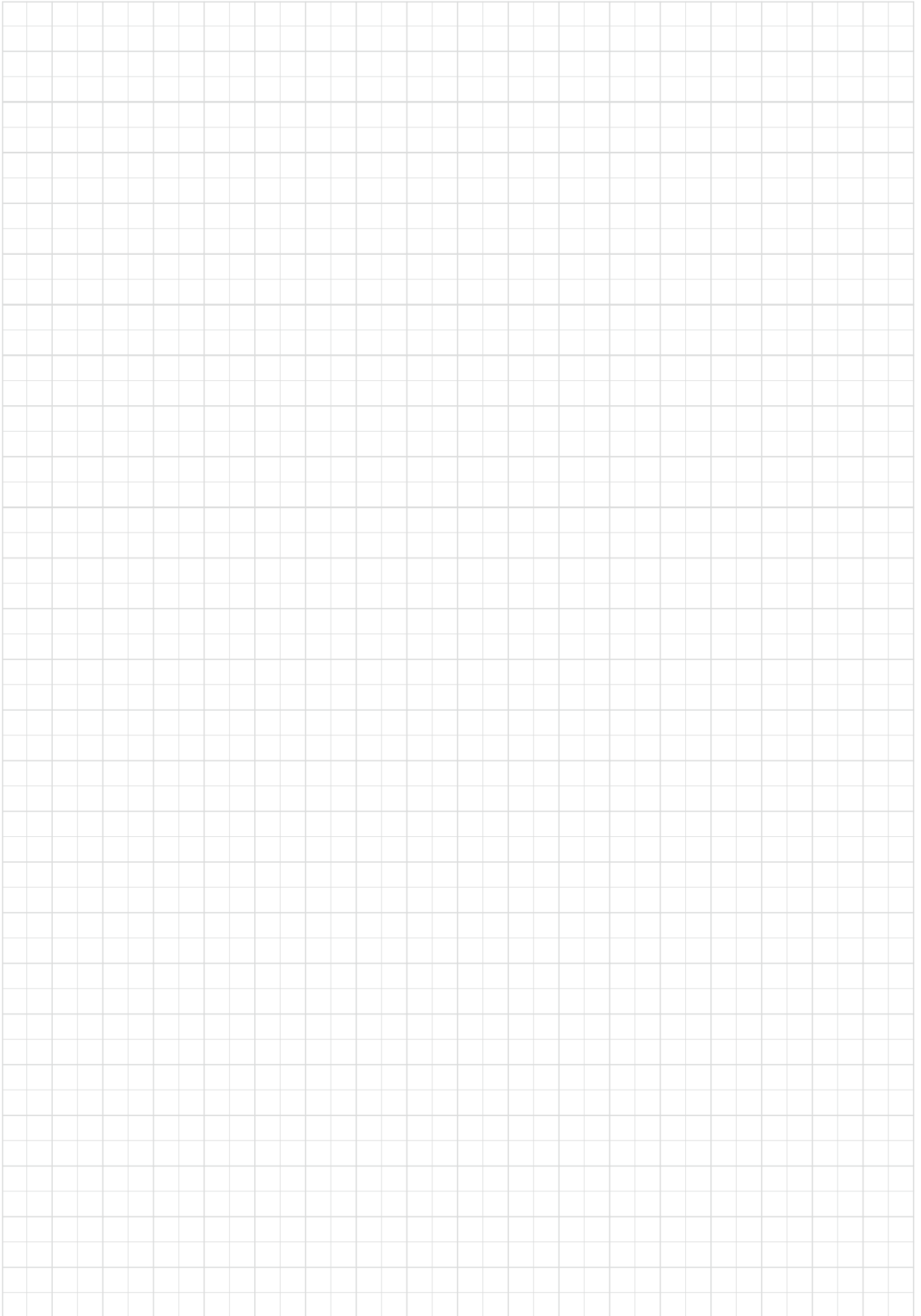

Worldwide Network



Tungaloy Corporation Head Office

11-1 Yoshima Kogyodanchi
Iwaki 970-1144 Japan
Phone: +81-246-36-8501
Fax: +81-246-36-8542
tungaloy.com/jp

Iwaki Plant

Products: Cutting Tools

Nagoya Plant

Products: Cutting Tools

Kyushu Plant

Products: CBN
PCD Tools
Deep Hole Drills

Nirasaki Plant

Products: Cutting Tools
Friction Materials (TungFric)
Wear Resistant Tools
Civil Engineering Tools



Tungaloy-NTK America Inc.

3726 N. Ventura Drive
Arlington Heights
IL 60004, U.S.A.
Phone: +1-888-554-8394
Fax: +1-888-554-8392
tungaloy.com/us

Tungaloy Canada

432 Elgin St. Unit 3, Brantford
Ontario N3S 7P7, Canada
Phone: +1-519-758-5779
Fax: +1-519-758-5791
tungaloy.com/ca

Tungaloy-NTK De Mexico S.A.

C/ Los Arellano 113
Parque Industrial Siglo XXI
Aguascalientes, AGS
Mexico 20290
Phone: +52-449-929-5410
Fax: +52-449-929-5411
tungaloy.com/mx

Tungaloy-NTK do Brasil Ltda.

Avd. Independencia N4158
Residencial Flora
13280-000 Vinhedo
São Paulo, Brazil
Phone: +55-19-38262757
Fax: +55-19-38262757
tungaloy.com/br

Tungaloy-NTK Germany GmbH.

Katzbergstr. 3a
D-40764 Langenfeld, Germany
Phone: +49-2173-90420-0
Fax: +49-2173-90420-19
tungaloy.com/de

Tungaloy France s.a.s

Les Fjords
19 avenue de Norvège
91140 Villebon Sur Yvette, France
Phone: +33-1-6486-4300
Fax: +33-1-6907-7817
tungaloy.com/fr

Tungaloy Italia S.r.l.

Via E. Andolfato 10
I-20126 Milano, Italy
Phone: +39-02-252012-1
Fax: +39-02-252012-65
tungaloy.com/it

Tungaloy Czech s.r.o

Turanka 115
CZ-627 00 Brno, Czech Republic
Phone: +420-532 123 391
Fax: +420-532 123 392
tungaloy.com/cz

Tungaloy Ibérica S.L.

C/Miquel Servet, 43B, Nau 7
Pol. Ind. Bufalvent
ES-08243 Manresa (BCN), Spain
Phone: +34 93 113 1360
tungaloy.com/es

Tungaloy Scandinavia AB

Bultgatan 38, 442 40
Kungälv, Sweden
Phone: +46-462119200
Fax: +46-462119207
tungaloy.com/se

Tungaloy Rus, LLC

Andropova avenue, h.18/7,
11 fl oor, office3, 115432,
Moscow, Russia
Phone: +7-499-683-01-80
Fax: +7-499-683-01-81
tungaloy.com/ru

Tungaloy Polska Sp. z o.o.

ul. Irysowa 1, 55-040 Bielany
Wroclawskie, Poland
Phone: +48 607 907 237
tungaloy.com/pl

Tungaloy-NTK UK Ltd.

Gallan Park, Watling Street,
Cannock, WS110XG, UK
Phone: +44 121 4000 231
Fax: +44 121 270 9694
tungaloy.com/uk

Tungaloy Hungary Kft

Erzsébet királyné útja 125
H-1142 Budapest, Hungary
Phone: +36 1 781-6846
Fax: +36 1 781-6866
tungaloy.com/hu

Tungaloy Turkey

Serifali Mah.bayraktar
Bulvari Kule Sk. No:26
34775 Umraniye / Istanbul / Turkey
Phone: +90 216 540 04 67
Fax: +90 216 540 04 87
tungaloy.com/tr

Tungaloy Benelux b.v.

Tjalk 70
NL-2411 NZ Bodegraven Netherlands
Phone: +31 172 630 420
Fax: +31 172 630 429
tungaloy.com/nl

Tungaloy Croatia

Ulica bana Josipa Jelačića 87,
10430 Samobor, Croatia
Phone: +385 1 3326 604
Fax: +385 1 3327 683
tungaloy.com/hr

Tungaloy Cutting Tool (Shanghai) Co. Ltd.

Rm No 401 No.88 Zhabei
Jiangchang No.3 Rd
Shanghai 200436, China
Phone: +86-21-3632-1880
Fax: +86-21-3621-1918
tungaloy.com/cn

Tungaloy-NTK Cutting Tool (Thailand) Co.,Ltd.

Interlink tower 4th Fl.
1858/5-7 Bangna-Trad Road
km.5 Bangna, Bangna, Bangkok
10260
Thailand
Phone: +66-2-751-5711
Fax: +66-2-751-5715
tungaloy.com/th

Tungaloy Cutting Tools Taiwan Co. Ltd.

9F. No.293, Zhongyang Rd,
Xinzhuang Dist, New Taipei City,
24251 Taiwan
Phone: +886-2-8521-9986
Fax: +886-2-8521-8935
tungaloy.com/tw

Tungaloy Singapore (Pte.), Ltd.

62 Ubi Road 1
#06-11 Oxley BizHub 2
Singapore 408734
Phone: +65-6391-1833
Fax: +65-6299-4557
tungaloy.com/sg

Tungaloy Vietnam

LE04.38, Lexington Residence
67 Mai Chi Tho, Dist. 2,
Ho Chi Minh City, Vietnam
Phone: +84-2837406660
tungaloy.com/vn

Tungaloy India Pvt. Ltd.

One International Center,
Unit # 902-A, 9th Floor,
Tower 1, Senapati Bapat Marg,
Elphinstone Road (West),
Mumbai -400013, India
Phone: +91-22-6124-8803
Fax: +91-22-6124-8899
tungaloy.com/in

Tungaloy Korea Co., Ltd

#1312, Byucksan Digital Valley 5-cha
Beotkot-ro 244, Geumcheon-gu
153-788 Seoul, Korea
Phone: +82-2-2621-6161
Fax: +82-2-6393-8952
tungaloy.com/kr

Tungaloy Malaysia Sdn Bhd

50 K-2, Kelana Mall, Jalan
SS6/14, Kelana Jaya, 47301
Petaling Jaya, Selangor Darul Ehsan
Malaysia
Phone: +603-7805-3222
Fax: +603-7804-8563
tungaloy.com/my

Tungaloy Australia Pty Ltd

Unit 68 1470 Ferntree Gully Road
Knoxfield 3180 Victoria, Australia
Phone: +61-3-9755-8147
Fax: +61-3-9755-6070
tungaloy.com/au

PT. Tungaloy Indonesia

Kompleks Grand Wisata Block AA-10
No.3-5 Cibitung
Bekasi 17510, Indonesia
Phone: +62-21-8261-5808
Fax: +62-21-8261-5809
tungaloy.com/id





11-1 Yoshima Kogyodanchi
Iwaki 970-1144 Japan
tungaloy.com

